

**WIN***SOURCE*  
**ELECTRONICS**

**THE DATASHEET OF**  
**130094**



130094 ✓ ACTIVE



PIDG

TE Internal #: 130094

Closed Ring Tongue Terminal, 16 – 14 AWG, M5 Stud, 5.26 mm [.207 in] Stud Diameter, Closed Barrel, Straight, Tin Plating, Partially Insulated, PIDG

[View on TE.com >](#)

Terminals & Splices > Ring Terminals > PIDG Ring Tongue Terminals

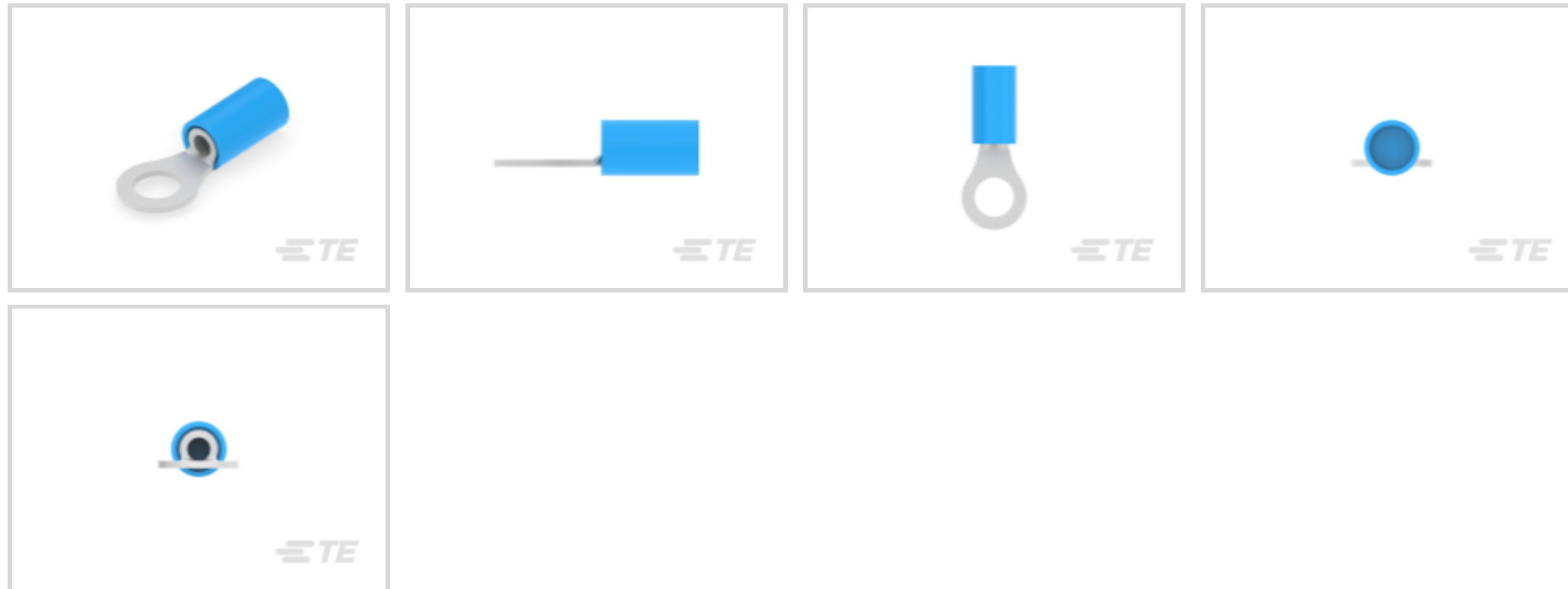

Ring Terminal Product Type: Closed Ring Tongue Terminal

Wire Size: 2050 – 5180 CMA

Stud Size: M5

[All PIDG Ring Tongue Terminals \(410\)](#)

Features

Configuration Features

|                 |   |
|-----------------|---|
| Number of Holes | 1 |
|-----------------|---|

Mechanical Attachment

|                         |      |
|-------------------------|------|
| Wire Insulation Support | With |
|-------------------------|------|

Electrical Characteristics

|                |       |
|----------------|-------|
| Voltage Rating | 300 V |
|----------------|-------|

Industry Standards

|                               |    |
|-------------------------------|----|
| Government Qualified Terminal | No |
|-------------------------------|----|

Body Features

|                |         |
|----------------|---------|
| Product Weight | 1.007 g |
|----------------|---------|

|                         |      |
|-------------------------|------|
| Insulation Sleeve Color | Blue |
|-------------------------|------|

|              |      |
|--------------|------|
| Stripe Color | Blue |
|--------------|------|

Packaging Features

|                    |      |
|--------------------|------|
| Packaging Quantity | 1000 |
|--------------------|------|



|                  |             |
|------------------|-------------|
| Packaging Method | Loose Piece |
|------------------|-------------|

### Product Type Features

|  |                             |
|--|-----------------------------|
| Ring Terminal Product Type             | Closed Ring Tongue Terminal |
| Stud Size                              | M5                          |
| Sealable                               | No                          |
| Wire Insulation Support Retention Type | Insulation Support          |

### Contact Features

|                           |          |
|---------------------------|----------|
| Barrel Type               | Closed   |
| Terminal Orientation      | Straight |
| Terminal Plating Material | Tin      |

### Dimensions

|                                      |                                |
|--------------------------------------|--------------------------------|
| Wire Size                            | 2050 – 5180 CMA                |
| Stud Diameter                        | 5.26 mm [.207 in]              |
| Tongue Thickness                     | .79 mm [.031 in]               |
| Product Length                       | 21.94 mm [.864 in]             |
| Compatible Insulation Diameter (Max) | 4.32 mm [.17 in]               |
| Compatible Insulation Diameter Range | 2.92 – 4.31 mm [.115 – .17 in] |

### Usage Conditions

|                   |                     |
|-------------------|---------------------|
| Insulation Option | Partially Insulated |
|-------------------|---------------------|

### Operation/Application

|                                       |        |
|---------------------------------------|--------|
| Compatible With Wire Base Material    | Copper |
| Compatible With Wire Plating Material | Tin    |

### Other

|                    |           |
|--------------------|-----------|
| EU RoHS Compliance | Compliant |
| EU ELV Compliance  | Compliant |

### Product Compliance

[For compliance documentation, visit the product page on TE.com>](#)

|   |   |
|---|---|
| EU RoHS Directive 2011/65/EU                  | Compliant                               |
| EU ELV Directive 2000/53/EC                   | Compliant                               |
| China RoHS 2 Directive MIIT Order No 32, 2016 | No Restricted Materials Above Threshold |
| EU REACH Regulation (EC) No. 1907/2006        |   |

Current ECHA Candidate List: JUNE 2024 (241)  
 Candidate List Declared Against: JUNE 2024 (241)  
 Does not contain REACH SVHC

Halogen Content  
 Low Halogen - Br, Cl, F, I < 900 ppm per homogenous material. Also BFR/CFR/PVC Free

Solder Process Capability  
 Not applicable for solder process capability

Product Compliance Disclaimer

This information is provided based on reasonable inquiry of our suppliers and represents our current actual knowledge based on the information they provided. This information is subject to change. The part numbers that TE has identified as EU RoHS compliant have a maximum concentration of 0.1% by weight in homogenous materials for lead, hexavalent chromium, mercury, PBB, PBDE, DBP, BBP, DEHP, DIBP, and 0.01% for cadmium, or qualify for an exemption to these limits as defined in the Annexes of Directive 2011/65/EU (RoHS2). Finished electrical and electronic equipment products will be CE marked as required by Directive 2011/65/EU. Components may not be CE marked. Additionally, the part numbers that TE has identified as EU ELV compliant have a maximum concentration of 0.1% by weight in homogenous materials for lead, hexavalent chromium, and mercury, and 0.01% for cadmium, or qualify for an exemption to these limits as defined in the Annexes of Directive 2000/53/EC (ELV). Regarding the REACH Regulation, the information TE provides on SVHC in articles for this part number is based on the latest European Chemicals Agency (ECHA) 'Guidance on requirements for substances in articles' posted at this URL: <https://echa.europa.eu/guidance-documents/guidance-on-reach>

## Compatible Parts





Also in the Series | PIDG

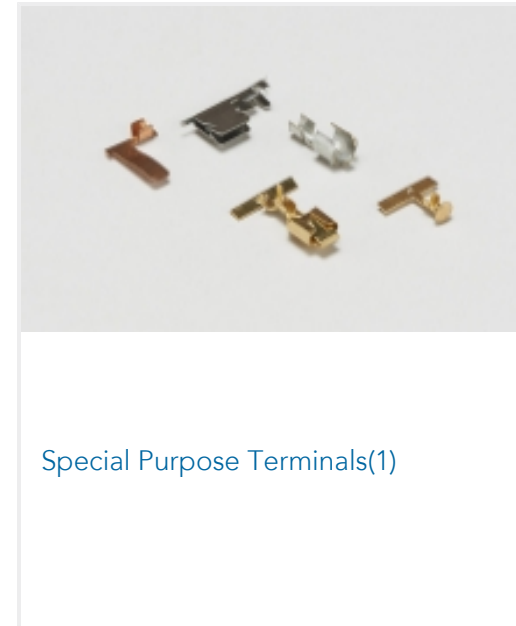
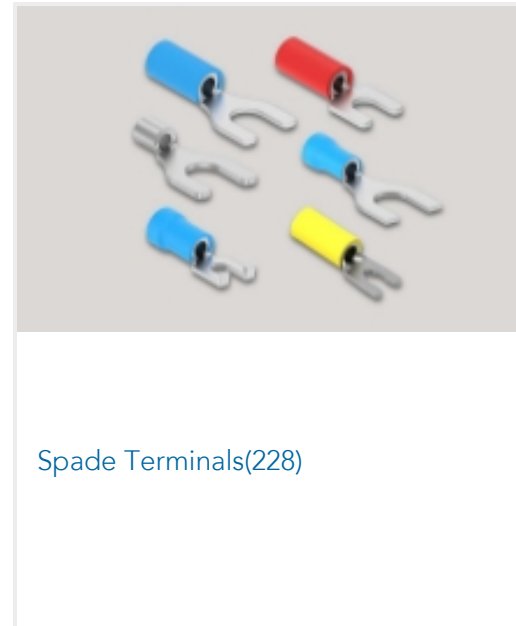
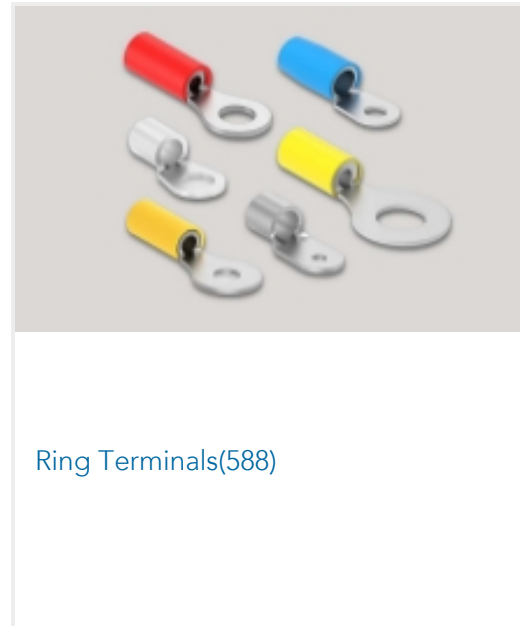
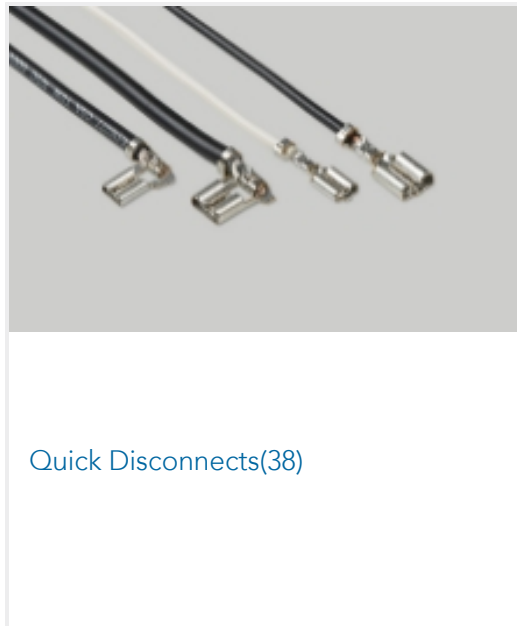
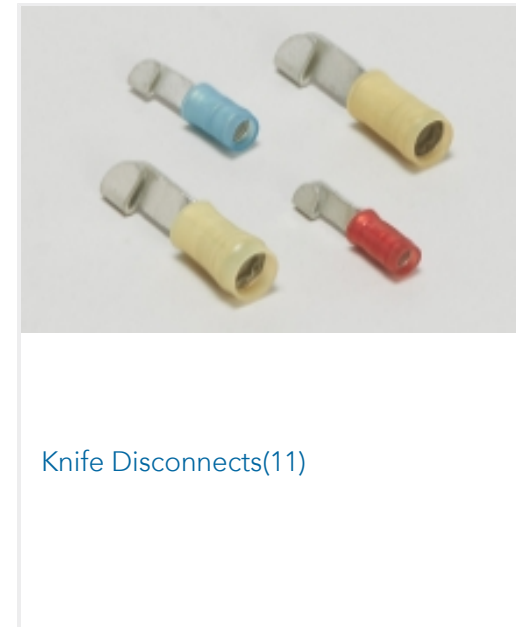
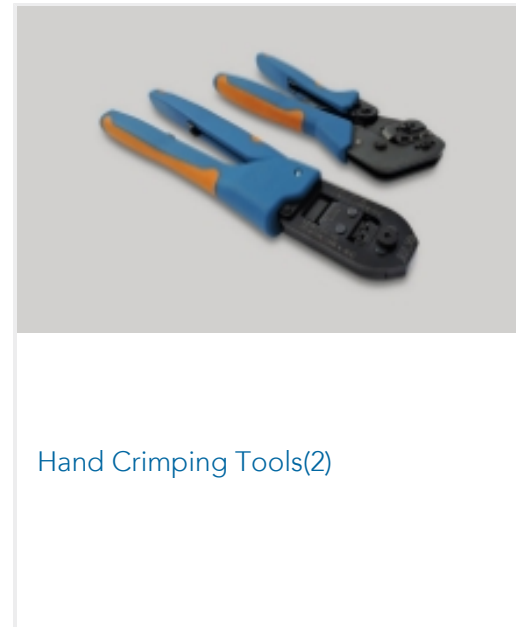
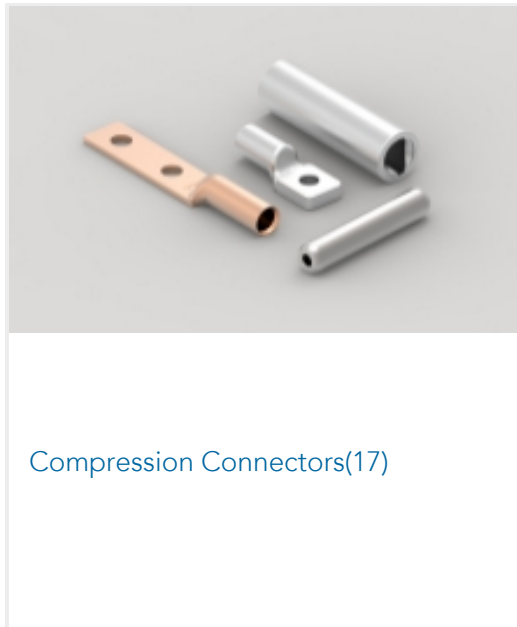

Customers Also Bought

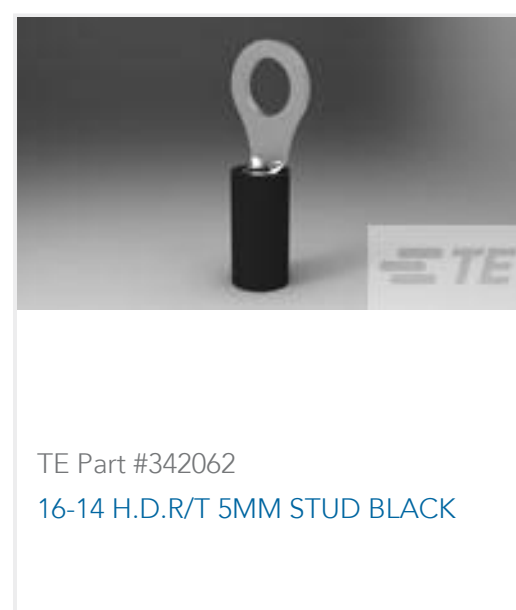
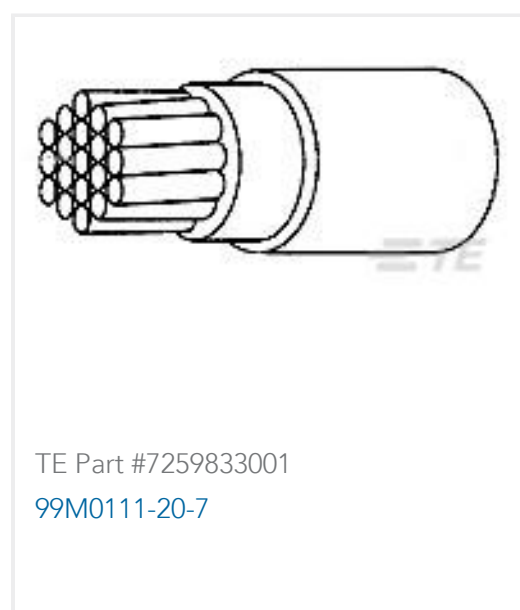

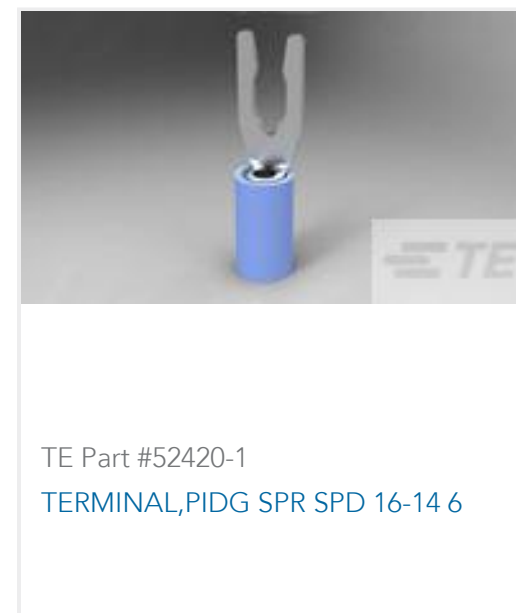

## Documents

### Product Drawings

#### PIDG RING

English

### CAD Files

#### Customer View Model

[ENG\\_CVM\\_CVM\\_130094\\_T.2d\\_dxf.zip](#)

English

#### 3D PDF

3D

#### Customer View Model

[ENG\\_CVM\\_CVM\\_130094\\_T.3d\\_igs.zip](#)

English

#### Customer View Model

[ENG\\_CVM\\_CVM\\_130094\\_T.3d\\_stp.zip](#)

English

By downloading the CAD file I accept and agree to the [Terms and Conditions](#) of use.

### Datasheets & Catalog Pages

#### PIDG TERMINALS & SPLICES Quick Reference Guide

English

### Instruction Sheets

#### Instruction Sheet (U.S.)

English

### Agency Approvals

#### CSA Certificate

130094

Closed Ring Tongue Terminal, 16 – 14 AWG, M5 Stud, 5.26 mm [.207 in] Stud Diameter, Closed Barrel, Straight, Tin Plating, Partially Insulated, PIDG



English

Looking for pricing, stock, or lifecycle information?

Click below to explore more details on WIN SOURCE:

[View 130094 on WIN SOURCE](#)

[TE Connectivity Information](#)

### Optimize Your Supply Chain with WIN SOURCE Solutions

- ✓ Global Sourcing Solution
- ✓ Obsolete Management
- ✓ Cost Control Management
- ✓ Shortage Management
- ✓ Alternative Solution
- ✓ Excess Inventory Management