



**THE DATASHEET OF
B39921B9972P810**





RF360
Europe GmbH

Data sheet

SAW diplexer
Short range devices

Part number: B9972
Ordering code: B39921B9972P810

Date: October 15, 2022

Version: 2.2

Confidential and Proprietary – RF360 Europe GmbH

NO PUBLIC DISCLOSURE PERMITTED: Please report postings of this document on public servers or websites to: DocCtrlAgent@qualcomm.com.

Restricted Distribution: Not to be distributed to anyone who is not an employee of either Qualcomm Incorporated or its affiliated companies without the express approval of RF360 Europe GmbH.

Qualcomm products mentioned herein are products of Qualcomm Technologies, Inc. and/or its subsidiaries.

RF360 Europe GmbH
Anzinger Straße 13
81671 Munich, Germany

These materials, including the information contained herein, may be used only for informational purposes by the customer. Qualcomm Technologies, Inc. and/or its subsidiaries assume no responsibility for errors or omissions in these materials or the information contained herein and reserve the right to make changes to the product(s) or information contained herein without notice. The materials and information are provided on an AS IS basis, without warranty, either expressed or implied, with respect to the materials, or any output or results based on the use, application, or evaluation of such materials, including without limitation, with respect to the non-infringement of trademarks, patents, copyrights or any other intellectual property rights or other rights of third parties.

No use of this documentation or any information contained herein grants any license, whether express, implied, by estoppel or otherwise, to any intellectual property rights, including, without limitation, to any patents owned by QUALCOMM Incorporated or any of its subsidiaries.

Not to be used, copied, reproduced, or modified in whole or in part, nor its contents revealed in any manner to others without the express written permission of RF360 Europe GmbH.

Qualcomm is a trademark or registered trademark of Qualcomm Incorporated. Other product and brand names may be trademarks or registered trademarks of their respective owners.

This technical data may be subject to U.S. and international export, re-export, or transfer ("export") laws. Diversion contrary to U.S. and international law is strictly prohibited.

Table of contents

1	Application	4
2	Features	4
3	Package	5
4	Pin configuration	5
5	Matching circuit	6
6	Characteristics Filter1	7
7	Characteristics Filter2	8
8	Maximum ratings	9
9	Transmission coefficient Filter1	10
10	Reflection coefficients Filter1	11
11	Transmission coefficient Filter2	12
12	Reflection coefficients Filter2	13
13	Packing material	14
14	Marking	17
15	Soldering profile	18
16	Annotations	19
17	Cautions and warnings	20
18	ESD protection of acoustic devices	21
19	Important notes	22

1 Application

- Low-loss RF filter for remote control receivers
- Filter1: 915 MHz (pass band 26 MHz)
- Filter2: 866.5 MHz (pass band 7 MHz)
- External matching circuit required for operating at 50 Ω

2 Features

- Approximate weight 3 mg
- Package size 1.5 \pm 0.1 mm \times 1.1 \pm 0.1 mm
- Package height 0.45 mm (max.)
- RoHS compatible
- Package for Surface Mount Technology (SMT)
- Ni/Au-plated terminals
- Electrostatic Sensitive Device (ESD)
- Moisture Sensitivity Level 3 (MSL3)

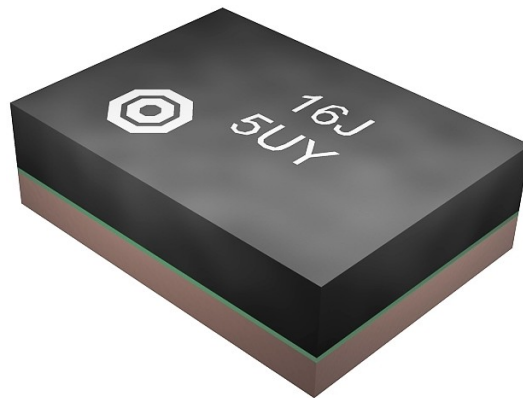
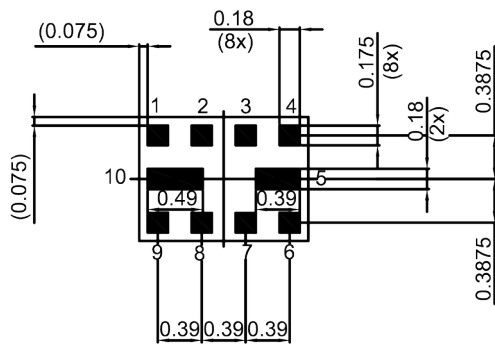

Figure 1: Picture of component with example of product marking.

3 Package

BOTTOM VIEW



Pad and pitch tolerance ± 0.05

SIDE VIEW



TOP VIEW

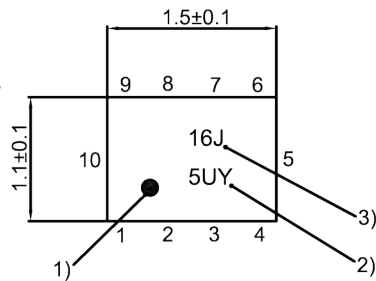

- 1) Marking for pad number 1
- 2) Example of encoded lot number
- 3) Example of encoded filter type number

Land pattern
THRU VIEW

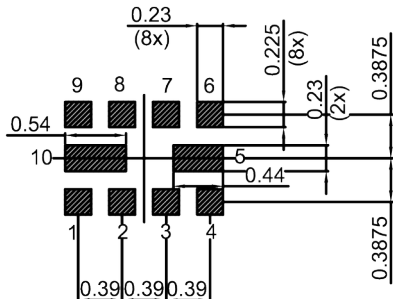

Landing pad tolerance -0.02

Figure 2: Drawing of package with package height A = 0.45 mm (max.). See Sec. Package information (p. 20).

4 Pin configuration

- 1 Input (Filter1; Filter2)
- 6 Output (Filter1)
- 9 Output (Filter2)
- 2, 3, 4, 5, 7, 8, 10 Ground

5 Matching circuit

- $L_{p1} = 13.5 \text{ nH}$

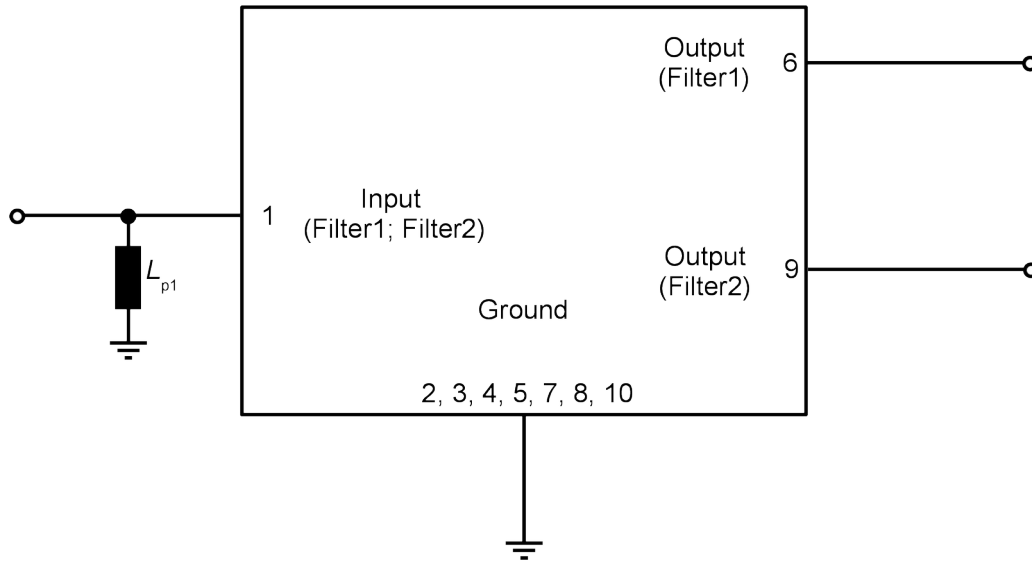

Figure 3: Schematic of matching circuit.

6 Characteristics Filter1

Temperature range for specification	T_{SPEC}	= 0 °C ... +70 °C
Input terminating impedance	Z_{IN}	= 50 Ω // 13.5 nH ¹⁾
Filter1 output terminating impedance	$Z_{Filter1 OUT}$	= 50 Ω
Filter2 output terminating impedance	$Z_{Filter2 OUT}$	= 50 Ω

Characteristics Filter1			min. for T_{SPEC}	typ. @ +25 °C	max. for T_{SPEC}	
Center frequency			—	915	—	MHz
Maximum insertion attenuation						
	902... 905	MHz	—	1.9	8.0 ²⁾	dB
	902... 928	MHz	—	1.9	3.0	dB
	905... 928	MHz	—	1.9	3.0 ²⁾	dB
Amplitude ripple (p-p)						
	902... 905	MHz	—	0.4	6.5 ²⁾	dB
	902... 928	MHz	—	0.8	2.0	dB
	905... 928	MHz	—	0.4	2.0 ²⁾	dB
Maximum VSWR						
@ input port	902... 928	MHz	—	1.6	2.2	
@ Filter1 output port	902... 928	MHz	—	1.8	2.2	
Minimum attenuation						
	824... 894	MHz	10 ²⁾	29	—	dB
	824... 894	MHz	16	29	—	dB
	1910... 1930	MHz	38 ²⁾	46	—	dB
	1910... 1930	MHz	38	46	—	dB
	2400... 2500	MHz	34 ²⁾	46	—	dB
	2400... 2500	MHz	34	46	—	dB

¹⁾ See Sec. Matching circuit (p. 6).

²⁾ Valid for temperature $T = -40$ °C...+85 °C.

7 Characteristics Filter2

Temperature range for specification
Input terminating impedance
Filter1 output terminating impedance
Filter2 output terminating impedance

$T_{SPEC} = 0\text{ °C} \dots +70\text{ °C}$
 $Z_{IN} = 50\ \Omega // 13.5\text{ nH}^{1)}$
 $Z_{Filter1\ OUT} = 50\ \Omega$
 $Z_{Filter2\ OUT} = 50\ \Omega$

Characteristics Filter2			min. for T_{SPEC}	typ. @ +25 °C	max. for T_{SPEC}	
Center frequency			—	866.5	—	MHz
Maximum insertion attenuation						
	863... 870	MHz	—	2.6	6.2 ²⁾	dB
	863... 870	MHz	—	2.6	3.3	dB
Amplitude ripple (p-p)						
	863... 870	MHz	—	0.7	5.0 ²⁾	dB
	863... 870	MHz	—	0.7	1.5	dB
Maximum VSWR						
@ input port	863... 870	MHz	—	1.8	2.2	
@ Filter2 output port	863... 870	MHz	—	2.0	2.2	
Minimum attenuation						
	791... 821	MHz	35 ²⁾	49	—	dB
	791... 821	MHz	35	49	—	dB
	880... 960	MHz	16 ²⁾	29	—	dB
	880... 960	MHz	16	29	—	dB
	1880... 1900	MHz	36 ²⁾	40	—	dB
	1880... 1900	MHz	36	40	—	dB
	2400... 2500	MHz	26 ²⁾	34	—	dB
	2400... 2500	MHz	26	34	—	dB

¹⁾ See Sec. Matching circuit (p. 6).

²⁾ Valid for temperature $T = -40\text{ °C} \dots +85\text{ °C}$.

8 Maximum ratings

Operable temperature	$T_{OP} = -40\text{ °C} \dots +85\text{ °C}$	
Storage temperature	$T_{STG}^{1)} = -40\text{ °C} \dots +85\text{ °C}$	
DC voltage	$ V_{DC} ^{2)} = 0\text{ V}$	
Input power	P_{IN}	
@ input port: 863 ... 870 MHz	17 dBm	Continuous wave for 5000 h @ 85 °C.
@ input port: 902 ... 928 MHz	16 dBm	Continuous wave for 5000 h @ 85 °C.

¹⁾ Not valid for packaging material. Storage temperature for packaging material is -25 °C to +40 °C.

²⁾ In case of applied DC voltage blocking capacitors are mandatory.

9 Transmission coefficient Filter1

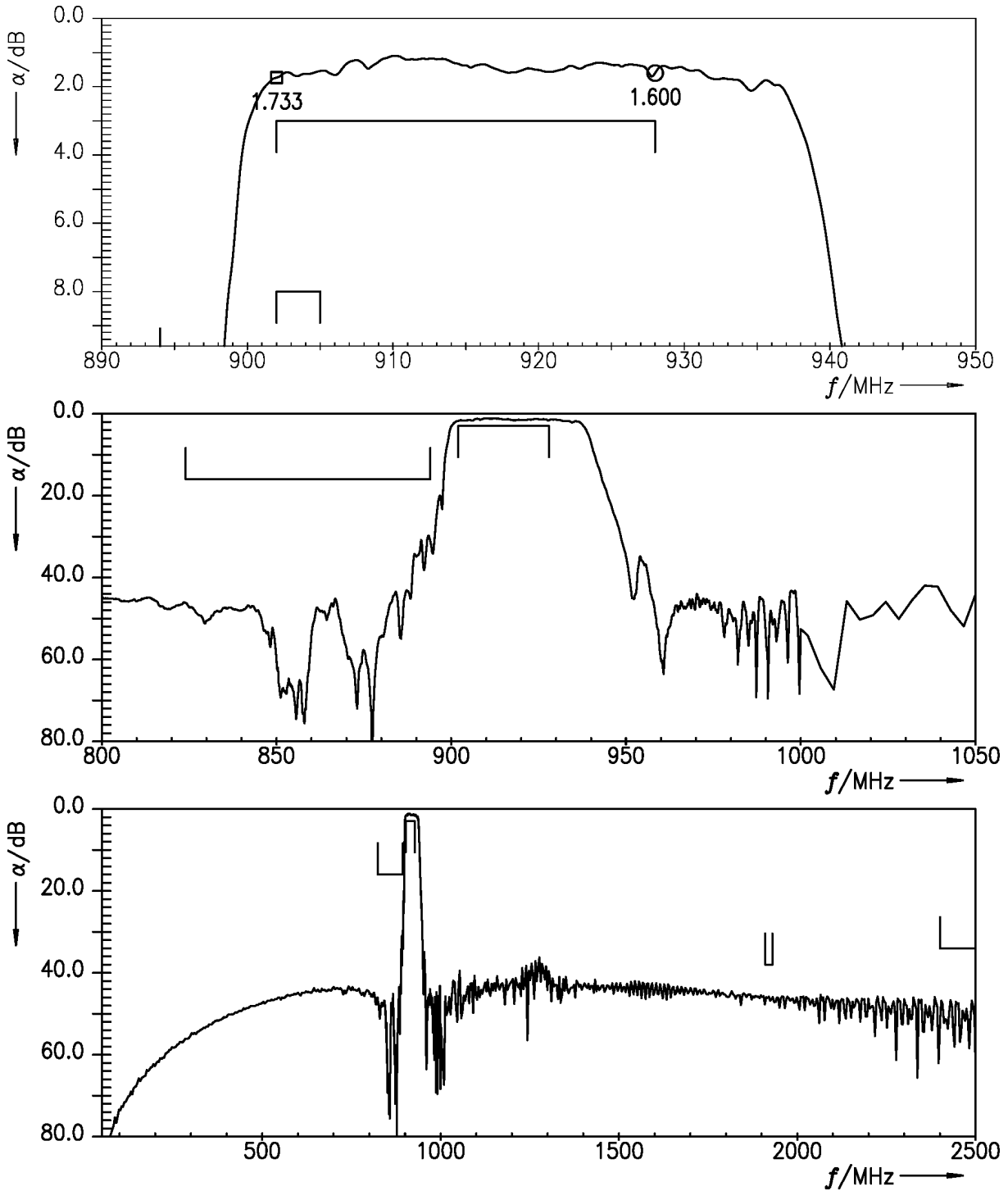

Figure 4: Attenuation Filter1.

10 Reflection coefficients Filter1

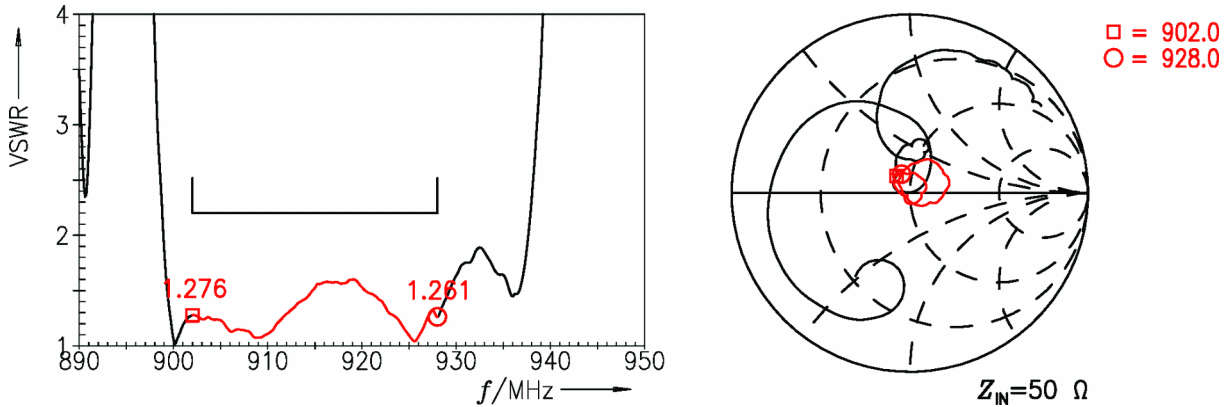

Figure 5: Reflection coefficient at input port (IN and OUT frequencies).

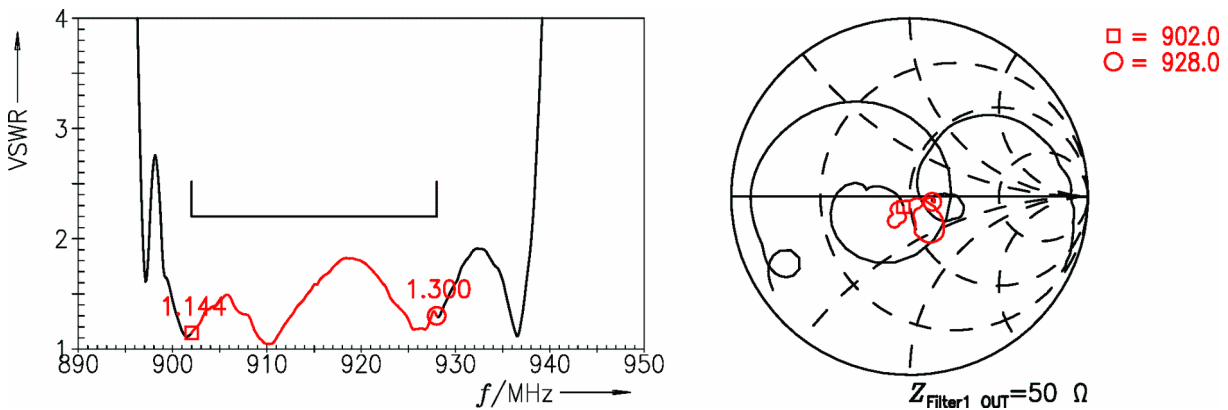

Figure 6: Reflection coefficient at Filter1 OUT port.

11 Transmission coefficient Filter2

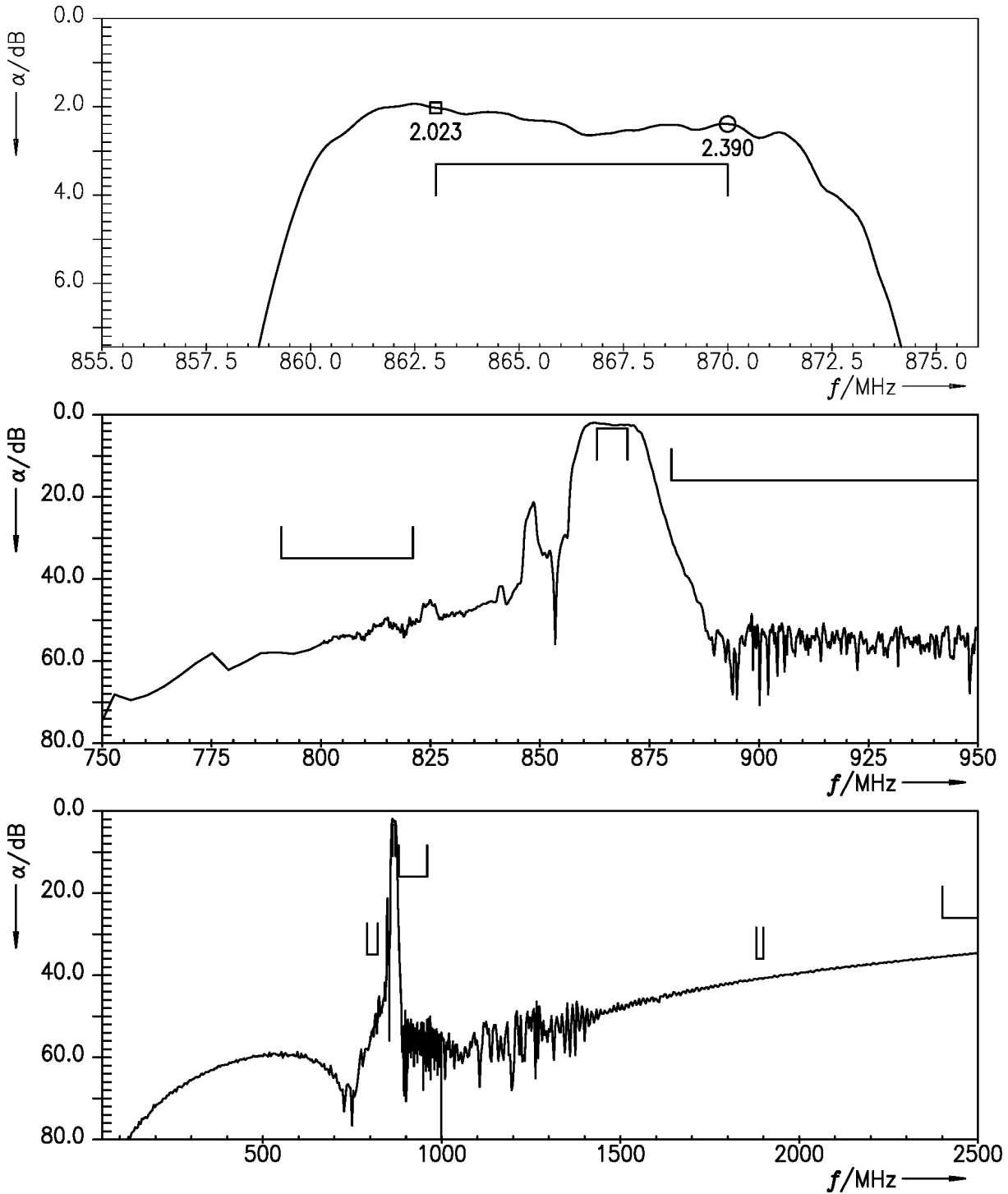

Figure 7: Attenuation Filter2.

12 Reflection coefficients Filter2

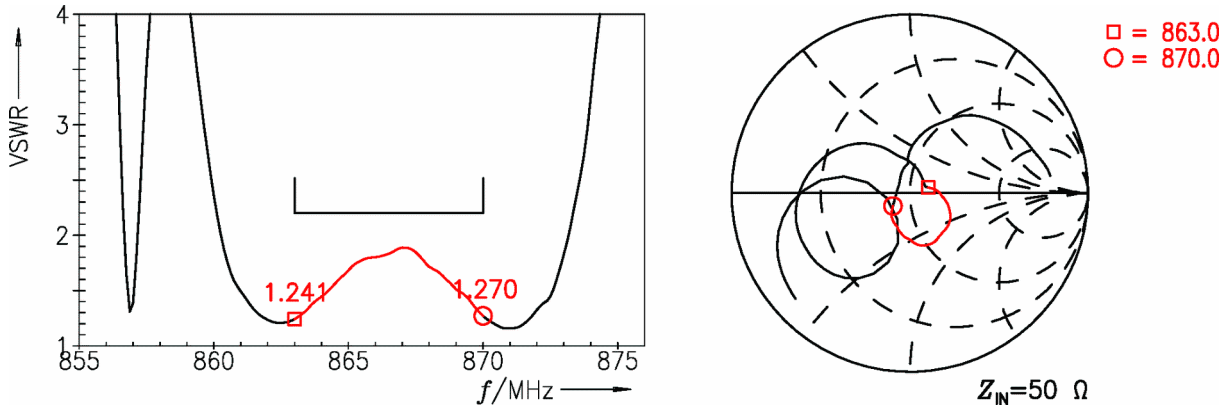

Figure 8: Reflection coefficient at input port (IN and OUT frequencies).

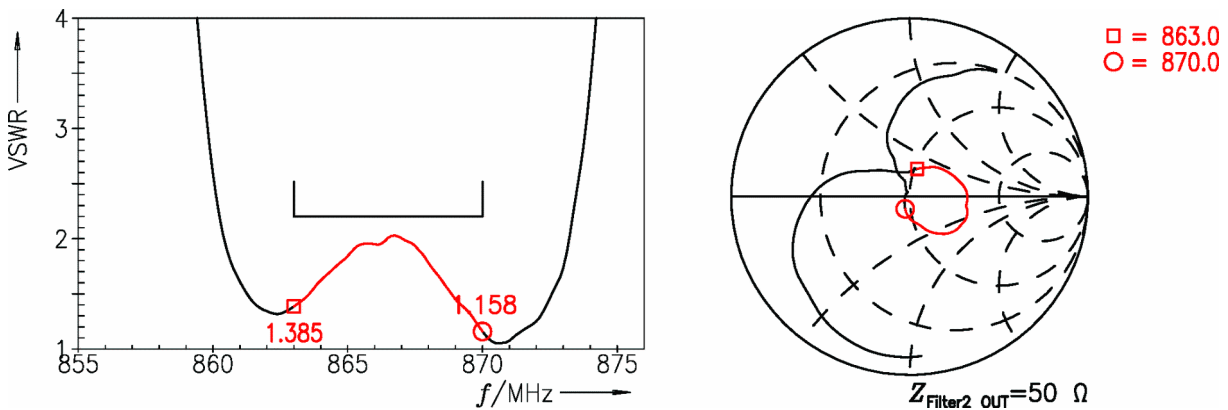

Figure 9: Reflection coefficient at Filter2 OUT port.

13 Packing material

13.1 Tape

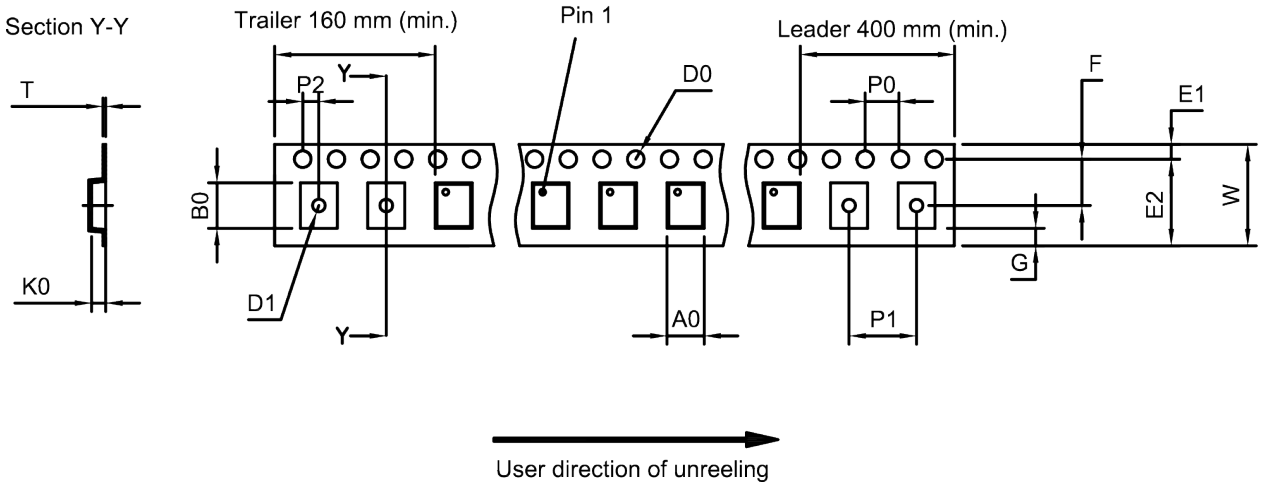

Figure 10: Drawing of tape (first-angle projection) for illustration only and not to scale. The valid tape dimensions are listed in Table 1.

A ₀	1.27±0.05 mm	E ₂	6.25 mm (min.)	P ₁	4.0±0.1 mm
B ₀	1.67±0.05 mm	F	3.5±0.05 mm	P ₂	2.0±0.05 mm
D ₀	1.5+0.1/-0 mm	G	0.75 mm (min.)	T	0.25±0.03 mm
D ₁	0.5+0.1/-0 mm	K ₀	0.55±0.05 mm	W	8.0+0.3/-0.1 mm
E ₁	1.75±0.1 mm	P ₀	4.0±0.1 mm		

Table 1: Tape dimensions.

13.2 Reel with diameter of 180 mm

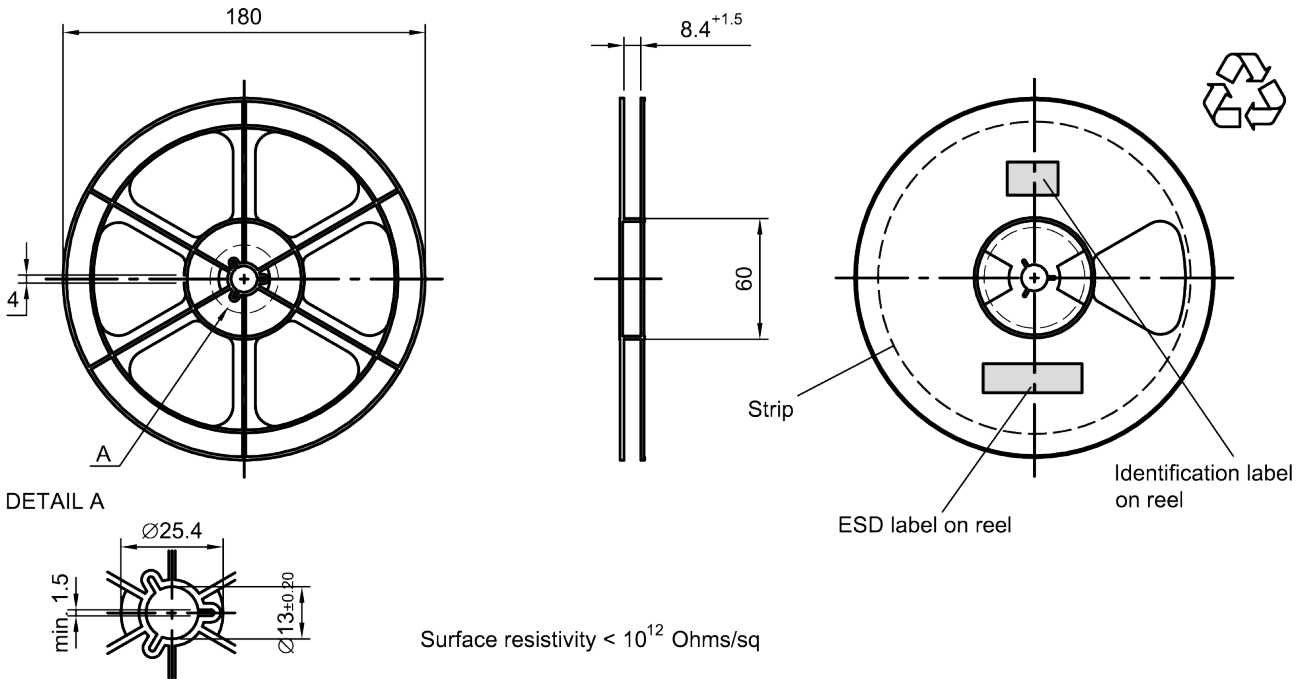

Figure 11: Drawing of reel (first-angle projection) with diameter of 180 mm.

Dimensions [mm]

X = 220+5

Y = 235+5

Sealing area 10±3

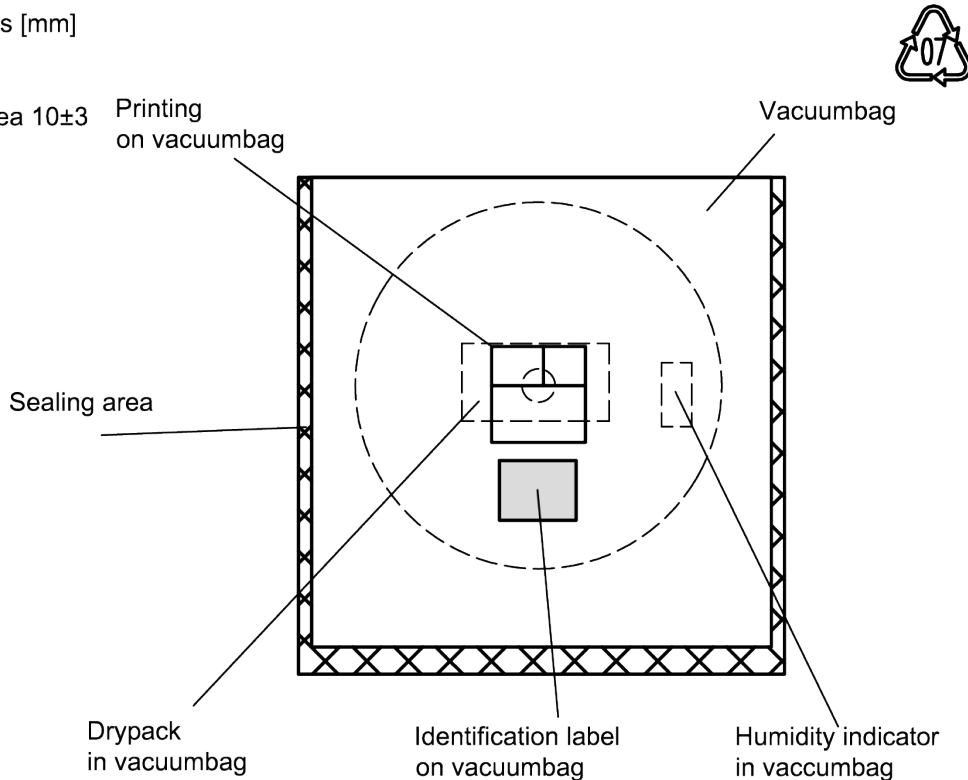

Figure 12: Drawing of moisture barrier bag (MBB) for reel with diameter of 180 mm.

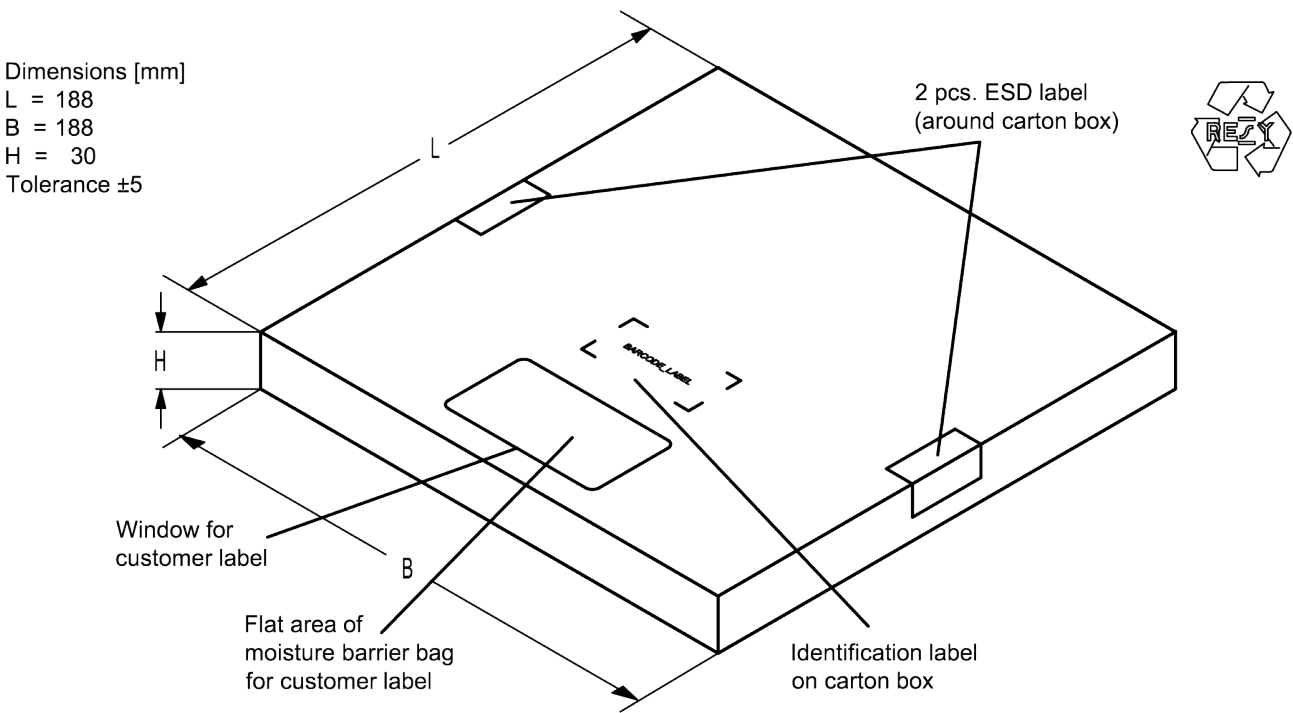

Figure 13: Drawing of folding box for reel with diameter of 180 mm.

14 Marking

Products are marked with product type number and lot number encoded according to Table 2:

■ Type number:

The 4 digit type number of the ordering code, e.g., B3xxxxB**1234**xxxx,
is encoded by a special BASE32 code into a 3 digit marking.

Example of decoding type number marking on device in decimal code.
16J => **1234**
 $1 \times 32^2 + 6 \times 32^1 + 18 (=J) \times 32^0 =$ **1234**

The BASE32 code for product type B9972 is 9QM.

■ Lot number:

The last 5 digits of the lot number, e.g., **12345**,
are encoded based on a special BASE47 code into a 3 digit marking.

Example of decoding lot number marking on device in decimal code.
5UY => **12345**
 $5 \times 47^2 + 27 (=U) \times 47^1 + 31 (=Y) \times 47^0 =$ **12345**

Adopted BASE32 code for type number			
Decimal value	Base32 code	Decimal value	Base32 code
0	0	16	G
1	1	17	H
2	2	18	J
3	3	19	K
4	4	20	M
5	5	21	N
6	6	22	P
7	7	23	Q
8	8	24	R
9	9	25	S
10	A	26	T
11	B	27	V
12	C	28	W
13	D	29	X
14	E	30	Y
15	F	31	Z

Adopted BASE47 code for lot number			
Decimal value	Base47 code	Decimal value	Base47 code
0	0	24	R
1	1	25	S
2	2	26	T
3	3	27	U
4	4	28	V
5	5	29	W
6	6	30	X
7	7	31	Y
8	8	32	Z
9	9	33	b
10	A	34	d
11	B	35	f
12	C	36	h
13	D	37	n
14	E	38	r
15	F	39	t
16	G	40	v
17	H	41	\
18	J	42	?
19	K	43	{
20	L	44	}
21	M	45	<
22	N	46	>
23	P		

Table 2: Lists for encoding and decoding of marking.

15 Soldering profile

The recommended soldering process is in accordance with IEC 60068-2-58 – 3rd edit and IPC/JEDEC J-STD-020B.

ramp rate	≤ 3 K/s
preheat	125 °C to 220 °C, 150 s to 210 s, 0.4 K/s to 1.0 K/s
T > 220 °C	30 s to 70 s
T > 230 °C	min. 10 s
T > 245 °C	max. 20 s
T ≥ 255 °C	–
peak temperature T_{peak}	250 °C +0/-5 °C
wetting temperature T_{min}	230 °C +5/-0 °C for 10 s ± 1 s
cooling rate	≤ 3 K/s
soldering temperature T	measured at solder pads

Table 3: Characteristics of recommended soldering profile for lead-free solder (Sn95.5Ag3.8Cu0.7).

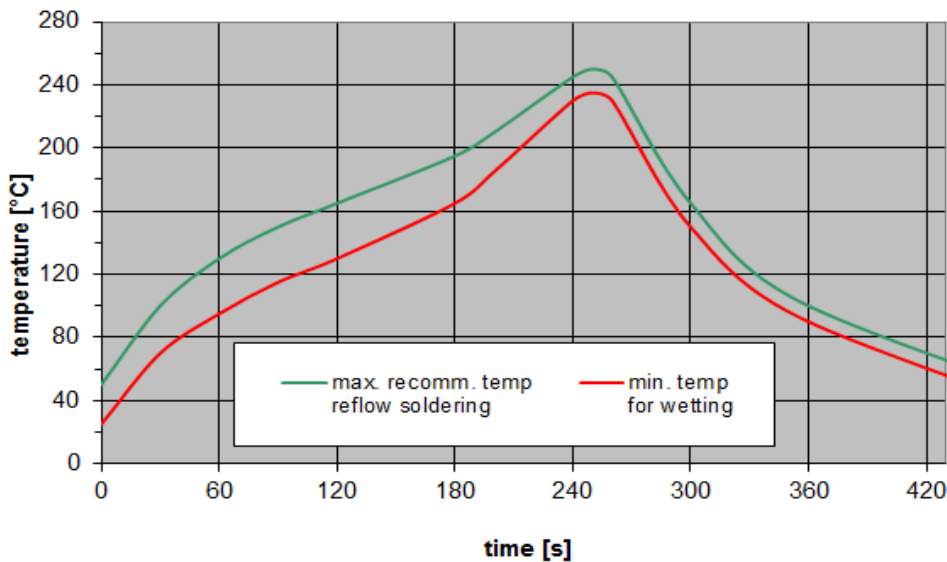

Figure 14: Recommended reflow profile for convection and infrared soldering – lead-free solder.

16 Annotations

16.1 RoHS compatibility

ROHS-compatible means that products are compatible with the requirements according to Art. 4 (substance restrictions) of Directive 2011/65/EU of the European Parliament and of the Council of June 8th, 2011, on the restriction of the use of certain hazardous substances in electrical and electronic equipment ("Directive") with due regard to the application of exemptions as per Annex III of the Directive in certain cases.

16.2 Scattering parameters (S-parameters)

The pin/port assignment is available in the headers of the S-parameter files. Please contact your local RF360 sales office.

16.3 Ordering codes, product IDs, labels, and packing units

Ordering code	Product ID	RF360 label	Packing unit
B39921B9972P810	B39921-B9972-P810	B39921B9972P810	5000 pcs
	B39921-B9972-P810-W05	B39921B9972P810W 5	5000 pcs

Table 4: Ordering codes / product IDs and packing units.

17 Cautions and warnings

17.1 Display of ordering codes for RF360 products

The ordering code for one and the same product can be represented differently in data sheets, data books, other publications and the website of RF360, or in order-related documents such as shipping notes, order confirmations and product labels. The varying representations of the ordering codes are due to different processes employed and do not affect the specifications of the respective products. Detailed information can be found on the Internet under <https://rfe.qualcomm.com/>.

17.2 Material information

Due to technical requirements components may contain dangerous substances. For information on the type in question please also contact one of our sales offices.

For information on recycling of tapes and reels please contact one of our sales offices.

17.3 Moldability

Before using in overmolding environment, please contact your local RF360 sales office.

17.4 Package information

Landing area

The printed circuit board (PCB) land pattern (landing area) shown is based on RF360 internal development and empirical data and illustrated for example purposes, only. As customers' SMD assembly processes may have a plenty of variants and influence factors which are not under control or knowledge of RF360, additional careful process development on customer side is necessary and strongly recommended in order to achieve best soldering results tailored to the particular customer needs.

Dimensions

Unless otherwise specified all dimensions are understood using unit millimeter (mm).

Projection method

Unless otherwise specified first-angle projection is applied.

18 ESD protection of acoustic devices

Acoustic devices are **Electro Static Discharge** sensitive devices. To reduce the probability of damages caused by ESD, special matching topologies must be applied.

In general, “ESD matching” must be ensured at that electrical port, where electrostatic discharge is expected.

Electrostatic discharges predominantly appear at the antenna input of RF receivers. Therefore, only the input matching of the acoustic device must be designed to short circuit or to block the ESD pulse.

Below three figures show recommended “ESD matching” topologies.

For wide band acoustic devices the high-pass ESD matching structure needs to be at least of 3rd order to ensure a proper matching for any impedance value of antenna and input port. The required component values must be determined from case to case.

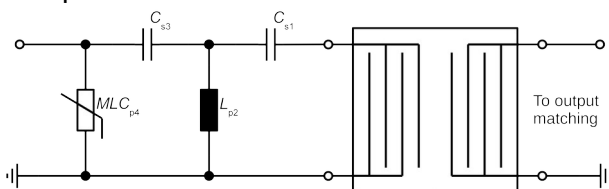

Figure 15: MLC varistor plus ESD matching.

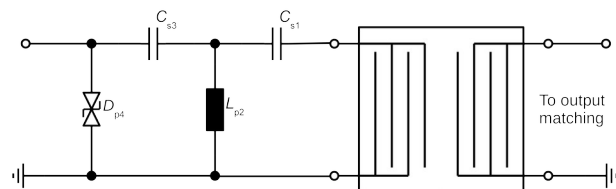

Figure 16: Suppressor diode plus ESD matching.

In cases where minor ESD occur, following simplified “ESD matching” topologies can be used alternatively.

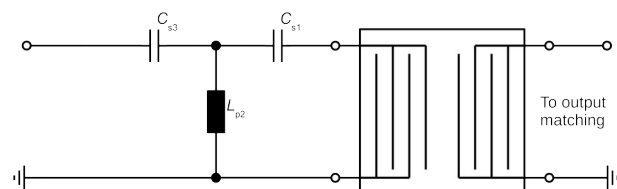

Figure 17: 3rd order high-pass structure for basic ESD protection.

In all three figures the shunt inductor L_{p2} could be replaced by a shorted microstrip with proper length and width. If this configuration is possible depends on the operating frequency and available PCB space.

Effectiveness of the applied ESD protection has to be checked according to relevant industry standards or customer specific requirements.

For further information, please refer to RF360 Application report: “**ESD protection for SAW filters**”. This report can be found under <https://rffe.qualcomm.com>.



19 Important notes

The following applies to all products named in this publication:







1. Some parts of this publication contain **statements about the suitability of our products for certain areas of application**. These statements are based on our knowledge of typical requirements that are often placed on our products in the areas of application concerned. We nevertheless expressly point out **that such statements cannot be regarded as binding statements about the suitability of our products for a particular customer application**. As a rule, RF360 Europe GmbH and its affiliates are either unfamiliar with individual customer applications or less familiar with them than the customers themselves. For these reasons, it is always ultimately incumbent on the customer to check and decide whether an RF360 product with the properties described in the product specification is suitable for use in a particular customer application.
2. We also point out that **in individual cases, a malfunction of electronic components or failure before the end of their usual service life cannot be completely ruled out in the current state of the art, even if they are operated as specified**. In customer applications requiring a very high level of operational safety and especially in customer applications in which the malfunction or failure of an electronic component could endanger human life or health (e.g. in accident prevention or life-saving systems), it must therefore be ensured by means of suitable design of the customer application or other action taken by the customer (e.g. installation of protective circuitry or redundancy) that no injury or damage is sustained by third parties in the event of malfunction or failure of an electronic component.
3. **The warnings, cautions and product-specific notes must be observed.**
4. In order to satisfy certain technical requirements, **some of the products described in this publication may contain substances subject to restrictions in certain jurisdictions (e.g. because they are classed as hazardous)**. Useful information on this will be found in our Material Data Sheets on the Internet (<https://rfe.qualcomm.com>). Should you have any more detailed questions, please contact our sales offices.
5. We constantly strive to improve our products. Consequently, **the products described in this publication may change from time to time**. The same is true of the corresponding product specifications. Please check therefore to what extent product descriptions and specifications contained in this publication are still applicable before or when you place an order. We also **reserve the right to discontinue production and delivery of products**. Consequently, we cannot guarantee that all products named in this publication will always be available.
The aforementioned does not apply in the case of individual agreements deviating from the foregoing for customer-specific products.

Looking for pricing, stock, or lifecycle information?

Click below to explore more details on WIN SOURCE:

-  [View B39921B9972P810 on WIN SOURCE](#)
-  [Qualcomm Information](#)

Optimize Your Supply Chain with WIN SOURCE Solutions

-  Global Sourcing Solution
-  Obsolete Management
-  Cost Control Management
-  Shortage Management
-  Alternative Solution
-  Excess Inventory Management