



THE DATASHEET OF SLAN-03D2ALG



SLAN-03D2A

Non-Isolated DC-DC Converter

The SLAN-03D2A modules are non-isolated DC-DC converters that can deliver up to 3 A of output current. These modules operate over a wide range of input voltage ($V_{in} = 3 - 14.4$ VDC) and provide a precisely regulated output voltage from 0.6 VDC to 5.5 VDC, programmable via an external resistor.

Features include remote on/off, adjustable output voltage, over current and over temperature protection. The tunable loop feature allows the user to optimize the dynamic response of the converter to match the load with reduced amount of output capacitance leading to savings on cost and PWB area.



Key Features & Benefits

- Non-Isolated
- Power Good signal
- Remote On/Off
- Over Temperature Protection
- Cost Efficient Open Frame Design
- Ability to Sink and Source Current
- DOSA Based
- Fixed Switching Frequency
- Output Voltage Programmable from 0.6 to 5.5 VDC via External Resistor
- Tunable Loop™ to Optimize Dynamic Output Voltage Response
- Output Over-Current Protection (non-latching)
- Small size: 12.19 × 12.19 × 6.25 mm (0.48 × 0.48 × 0.246 inch)
- Approved to IEC/EN 62368-1
- Approved to UL/CSA 62368-1
- Class II, Category 2, Isolated DC/DC Converter (refer to IPC-9592B)

Applications

- Distributed Power Architectures
- Intermediate Bus Voltage Applications
- Telecommunications Equipment
- Servers and Storage Applications
- Networking Equipment
- Industrial Equipment

1. MODEL SELECTION

MODEL NUMBER	OUTPUT VOLTAGE	INPUT VOLTAGE	MAX. OUTPUT CURRENT	MAX. OUTPUT POWER	TYPICAL EFFICIENCY
SLAN-03D2A0G	0.6 - 5.5 VDC	3 - 14.4 VDC	3 A	16.5 W	93.9 %
SLAN-03D2A0R					
SLAN-03D2ALG					
SLAN-03D2ALR					

PART NUMBER EXPLANATION

S	LAN	-	03	D	2A	x	y
Mounting Type	Series Code		Output Current	Input Voltage Range	Sequencing or not	Logic Status	Package
Surface Mount	SLAN Series		3 A	3 - 14.4 VDC	Without Sequencing	0 – Active High L – Active Low	G – Tray Package R – Tape & Reel Package

2. ABSOLUTE MAXIMUM RATINGS

PARAMETER	DESCRIPTION	MIN	TYP	MAX	UNITS
Continuous Input Voltage		-0.3	-	15	V
Operating Temperature	See Thermal Considerations section	-40	-	85	°C
Storage Temperature		-55	-	125	°C
Altitude		-	-	4000	m

NOTE: Stresses in excess of the absolute maximum ratings can cause permanent damage to the device. These are absolute stress ratings only, functional operation of the device is not implied at these or any other conditions in excess of those given in the operations sections of the data sheet. Exposure to absolute maximum ratings for extended periods can adversely affect the device reliability.

3. INPUT SPECIFICATIONS

PARAMETER	DESCRIPTION	MIN	TYP	MAX	UNIT
Operating Input Voltage		3	-	14.4	V
Input Current (full load)	VIN = 3 to 14 V, Io = Io max	-	-	2.4	A
Input Current (no load)	VO,set = 0.6 VDC	-	17	-	mA
	VO,set = 5 VDC	-	38	-	
Input Stand-by Current	Vin = 12 V, module disabled	-	0.8	-	mA
Input Reflected Ripple Current (pk-pk)	5 Hz to 20 MHz, 1 μH source impedance; VIN = 0 to 14 V, Io = Io max; See Test Configurations	-	15	-	mA
I ² t Inrush Current Transient		-	-	1	A ² s
Input Ripple Rejection (120 Hz)		-	-60	-	dB

NOTE: Unless otherwise indicated, specifications apply over entire operating input voltage range, resistive load, and temperature conditions.

4. OUTPUT SPECIFICATIONS

PARAMETER	DESCRIPTION	MIN	TYP	MAX	UNIT
Output Voltage Set Point	With 0.1% tolerance for external resistor used to set output voltage	-1.0	-	+1.0	%Vo set
Output Voltage	Over entire operating input voltage range, resistive load, and temperature conditions until end of life	-3.0	-	+3.0	%Vo set
Adjustment Range	1. Selected by an external resistor 2. Some output voltages may not be possible depending on the input voltage – see Feature Descriptions Section	0.6	-	5.5	V
Remote Sense Range		-	-	0.5	V
Line Regulation	$V_O \geq 2.5\text{ V}$ $V_O < 2.5\text{ V}$ VIN = VIN min to VIN max	-	-	0.4	%Vo set
Load Regulation	Io = Io min to Io max	-	-	10	mV
Temperature Regulation	Tref = Ta min to Ta max	-	-	0.4	%Vo set
Output Current	In either sink or source mode	0	-	3	A
Output Ripple and Noise (pk-pk)	5 Hz to 20 MHz BW, VIN = VIN nom and Io=Io min to Io max, Co = 0.1 μF // 22 μF ceramic capacitors)	-	50	100	mV
Output Ripple and Noise (rms)		-	20	38	mV
Output Short-Circuit Current	Vo \leq 250 mV, Hiccup Mode	-	0.5	-	A
Turn-On Delay Times (VIN=VIN nom, Io=Io max, Vo to within $\pm 1\%$ of steady state.)	Case 1: On/Off input is enabled and then input power is applied (delay from instant at which VIN = VIN min until Vo = 10% of Vo set)	-	4	-	ms
	Case 2: Input power is applied for at least one second and then the On/Off input is enabled (delay from instant at which Von/Off is enabled until Vo = 10% of Vo set) VIN = VIN min to Vin max, Io = Io min to Io max, TA=25°C. With or without maximum external capacitance	-	4.8	-	ms
Output Voltage Overshoot	TA=25°C. With or without maximum external capacitance	-	-	3.0	%Vo set.
Output Voltage Rise Time	Time for Vo to rise from 10% of Vo set to 90% of Vo set	-	2.8	-	ms
Output Capacitance**	ESR \geq 1 m Ω Without the Tunable Loop™	10	-	22	
	ESR \geq 0.15 m Ω With the Tunable Loop™	10	-	1000	μF
	ESR \geq 10 m Ω With the Tunable Loop™	10	-	3000	
Output Current Limit Inception	1. Hiccup Mode 2. Current limit does not operate in sink mode	-	200	-	% Io max

** External capacitors may require using the new Tunable Loop™ feature to ensure that the module is stable as well as getting the best transient response. See the Tunable Loop™ section for details.

NOTE: All specifications are typical at nominal input, full load at 25°C unless noted.

5. GENERAL SPECIFICATIONS

PARAMETER	DESCRIPTION	MIN	TYP	MAX	UNIT
Efficiency	Vo = 0.6 V (8 Vin)	-	75.0	-	%
	Vo= 1.2 V	-	82.8	-	%
	Vo= 1.8 V	-	88.2	-	%
	Vo= 2.5 V	-	89.9	-	%
	Vo= 3.3 V	-	91.6	-	%
	Vo= 5.0 V	-	93.9	-	%
Switching Frequency		-	600	-	kHz
Input Undervoltage Lockout	Turn-on Threshold	-	-	3.0	V
	Turn-off Threshold	-	2.69	-	V
	Hysteresis	-	0.2	-	V
Over Temperature Protection		-	135	-	°C
PGOOD (Power Good)	Over voltage threshold for PGOOD	-	112.5	-	%Vo set
	Under voltage threshold for PGOOD	-	87.5	-	%Vo set
	Pull down resistance of PGOOD pin	-	30	-	Ω
MTBF	Calculated MTBF (Io = 0.8 Io max, TA=40°C) Telecordia Issue 2 Method 1 Case 3	-	19,508,839	-	hrs
Weight		-	0.89	-	g
Dimensions (L × W × H)		0.48 x 0.48 x 0.246			inch
		12.19 x 12.19 x 6.25			mm

NOTE: Unless otherwise indicated, specifications apply over entire operating input voltage range, resistive load, and temperature conditions. See Feature Descriptions for additional information.

6. EFFICIENCY DATA

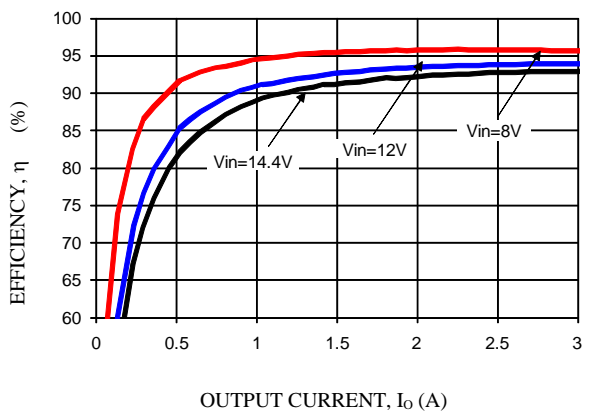
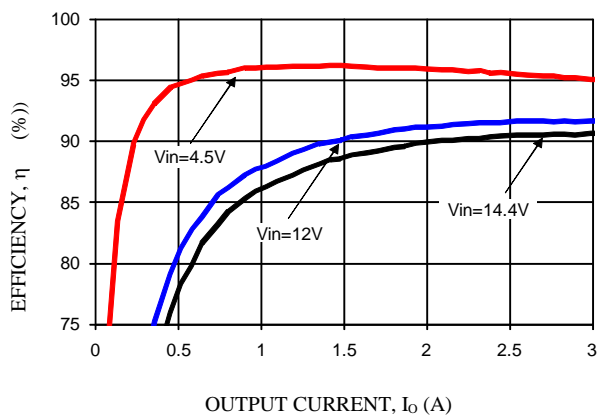
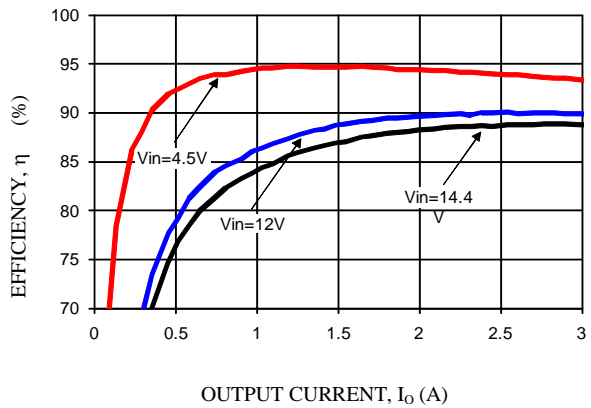
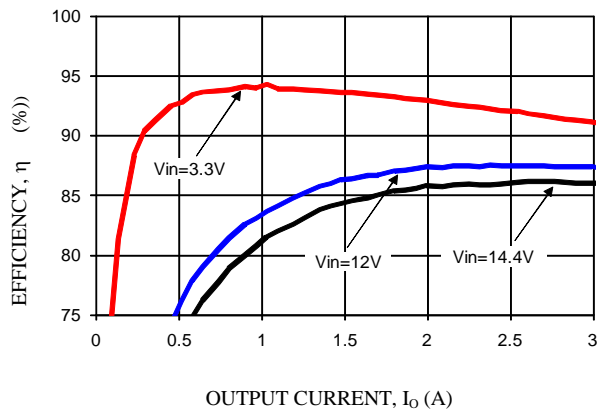
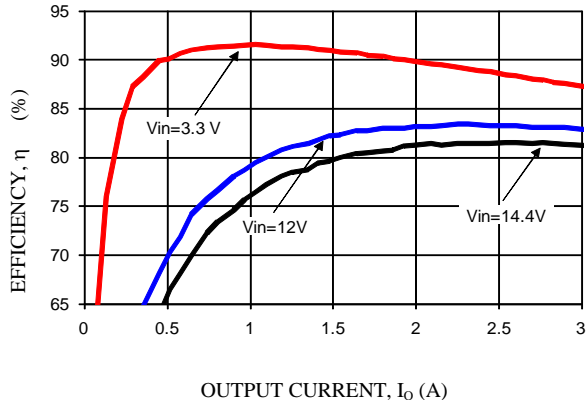
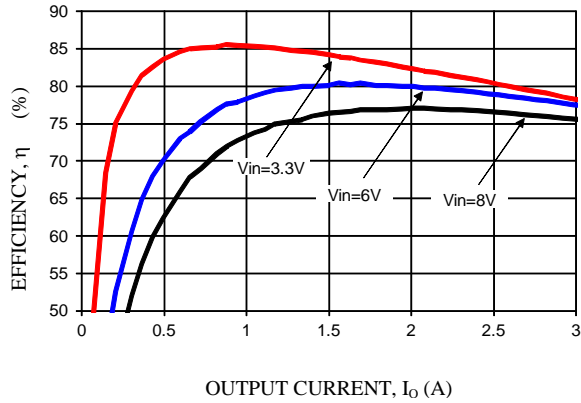

Asia-Pacific
+86 755 298 85888

Europe, Middle East
+353 61 49 8941

North America
+1 866 513 2839

7. THERMAL DERATING CURVES

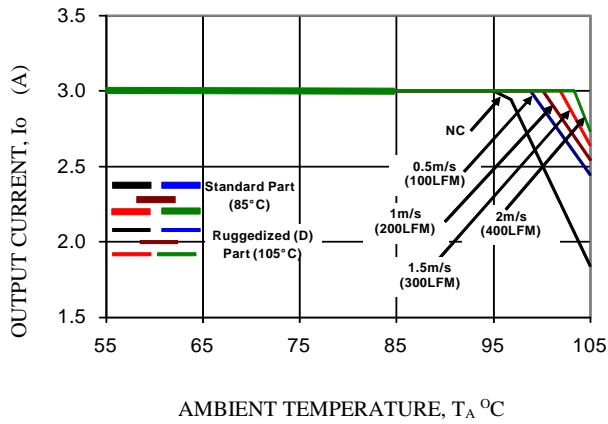

Figure 7. $V_o = 0.6 V$

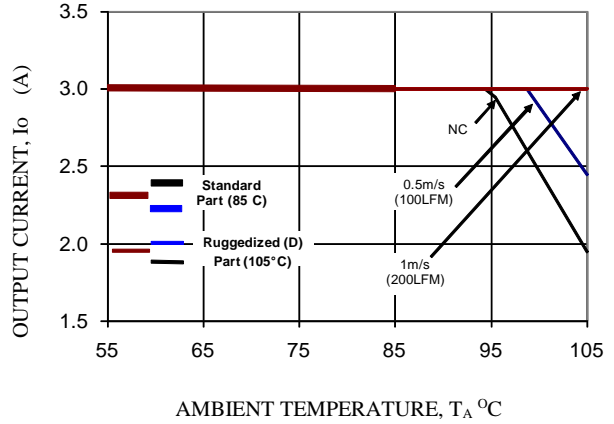

Figure 8. $V_o = 1.2 V$

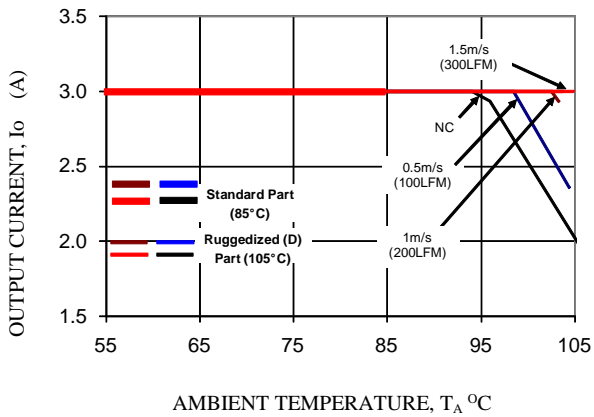

Figure 9. $V_o = 1.8 V$

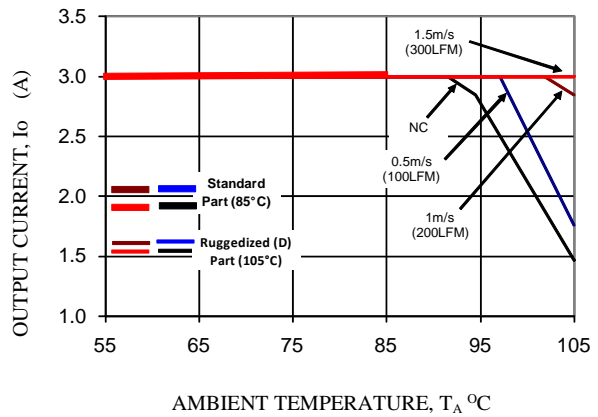

Figure 10. $V_o = 2.5 V$

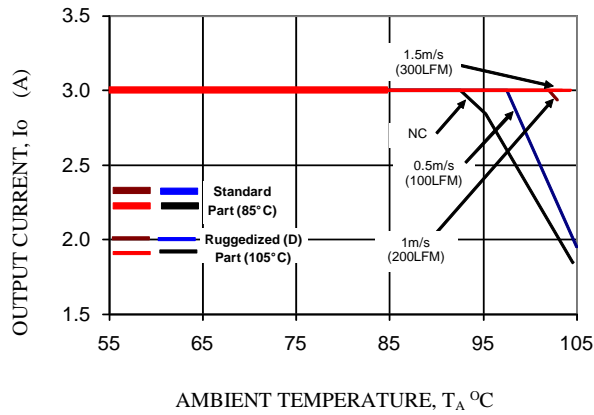

Figure 11. $V_o = 3.3 V$

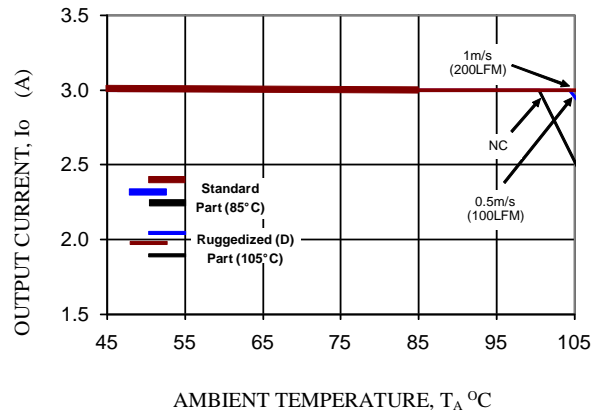

Figure 12. $V_o = 5.0 V$

8. OUTPUT RIPPLE AND NOISE WAVEFORMS

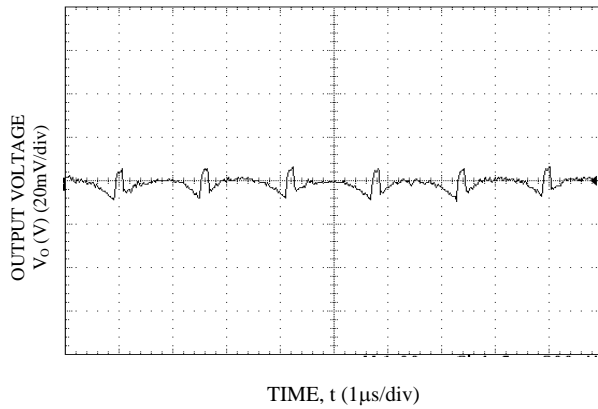

Figure 13. $V_o = 0.6\text{ V}$, $I_o = I_{o,max}$, $V_{in} = 8\text{ V}$

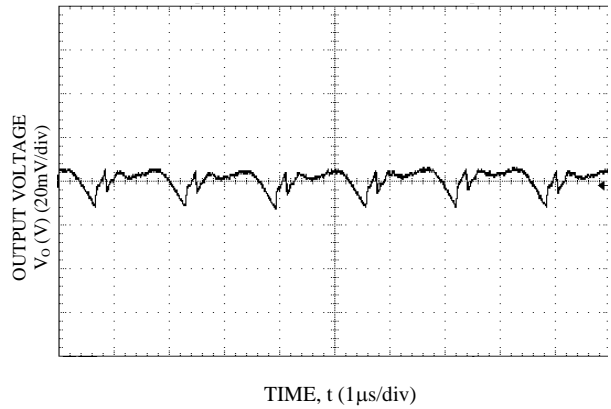

Figure 14. $V_o = 1.2\text{ V}$, $I_o = I_{o,max}$, $V_{in} = 12\text{ V}$

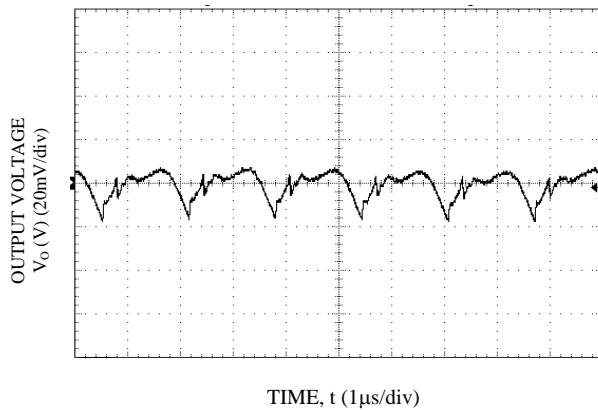

Figure 15. $V_o = 1.8\text{ V}$, $I_o = I_{o,max}$, $V_{in} = 12\text{ V}$

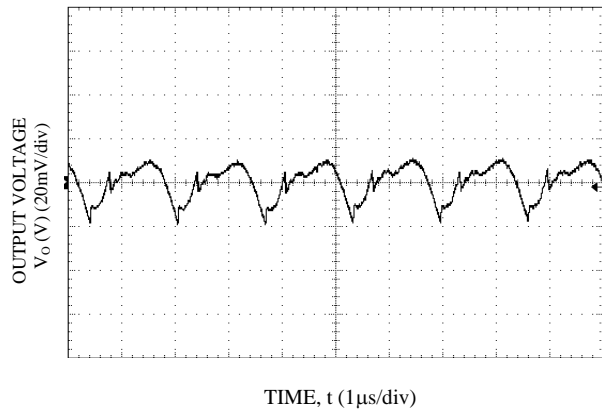

Figure 16. $V_o = 2.5\text{ V}$, $I_o = I_{o,max}$, $V_{in} = 12\text{ V}$

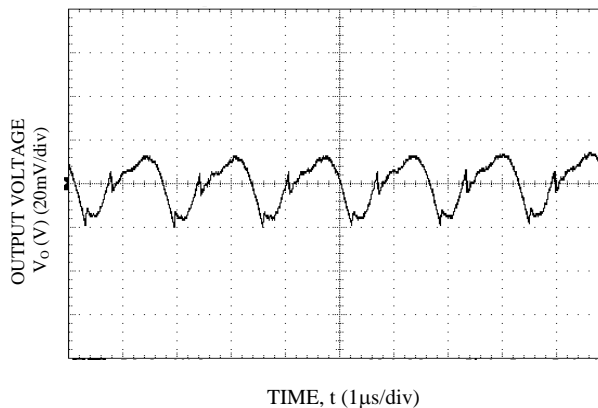

Figure 17. $V_o = 3.3\text{ V}$, $I_o = I_{o,max}$, $V_{in} = 12\text{ V}$

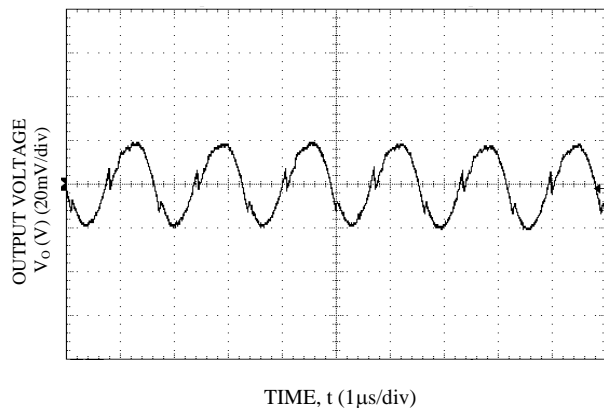

Figure 18. $V_o = 5.0\text{ V}$, $I_o = I_{o,max}$, $V_{in} = 12\text{ V}$

NOTE: $C_o = 10\ \mu\text{F}$ ceramic.

9. TRANSIENT RESPONSE WAVEFORMS

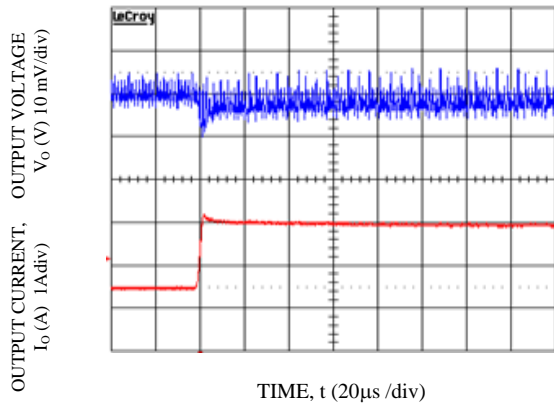

Figure 19. Transient Response to Dynamic Load Change from 50% to 100% at 8 Vin, Cout-1x47 μ F+2x330 μ F, CTune-27 nF & RTune-178 Ω . Vo = 0.6 V

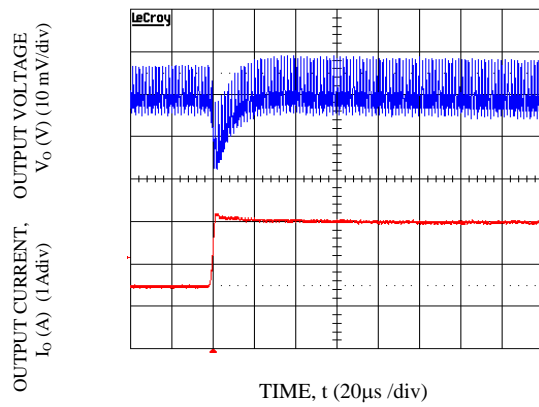

Figure 20. Transient Response to Dynamic Load Change from 50% to 100% at 12 Vin, Cout-1x47 μ F+1x330 μ F, CTune-10 nF & RTune-261 Ω . Vo = 1.2 V

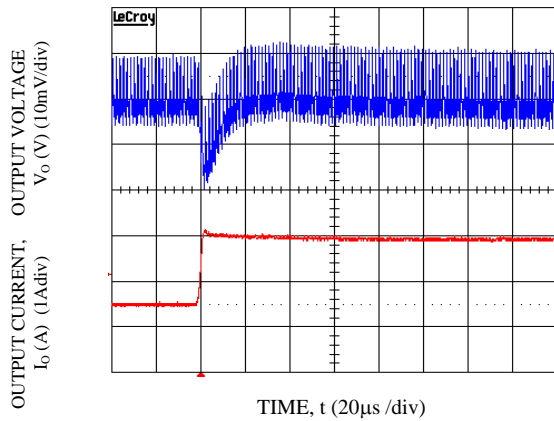

Figure 21. Transient Response to Dynamic Load Change from 50% to 100% at 12 Vin, Cout-1x47 μ F+1x330 μ F, CTune-10 nF & RTune-261 Ω . Vo = 1.8 V

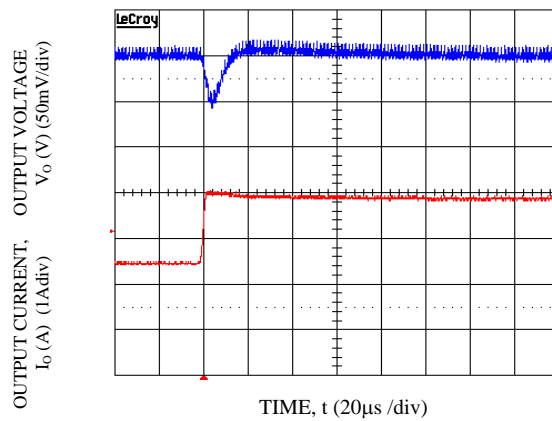

Figure 22. Transient Response to Dynamic Load Change from 50% to 100% at 12 Vin, Cout-2x47 μ F, CTune-2700 pF & RTune-261 Ω . Vo = 2.5 V

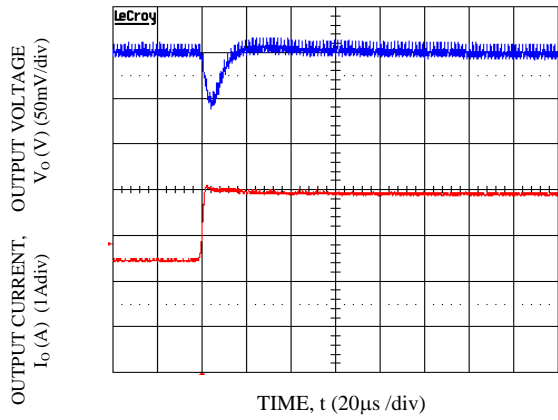

Figure 23. Transient Response to Dynamic Load Change from 50% to 100% at 12 Vin, Cout-2x47 μF, CTune-2200 pF & RTune-261 Ω. Vo = 3.3 V

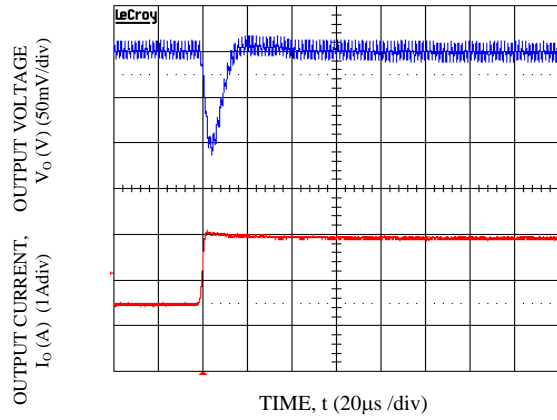

Figure 24. Transient Response to Dynamic Load Change from 50% to 100% at 12 Vin, Cout-1x47 μF, CTune-820 pF & RTune-261 Ω. Vo = 5 V

10. STARTUP TIME

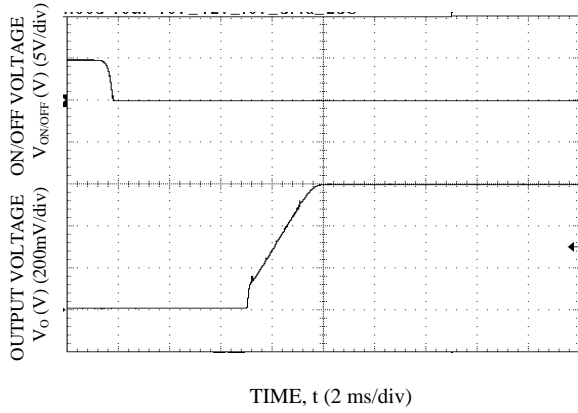

Figure 25. Start-up Using On/Off Voltage ($I_o = I_{o,max}$), $V_o = 0.6 V$

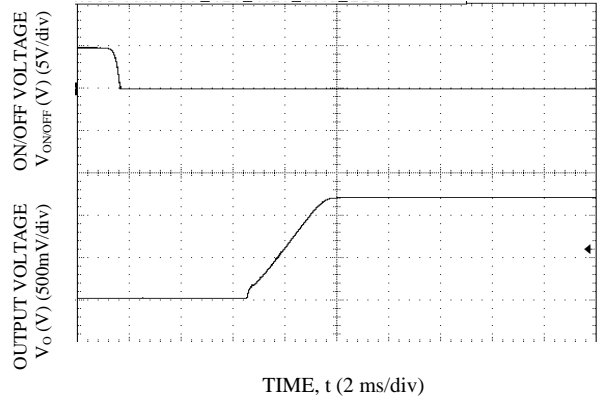

Figure 26. Start-up Using On/Off Voltage ($I_o = I_{o,max}$), $V_o = 1.2 V$

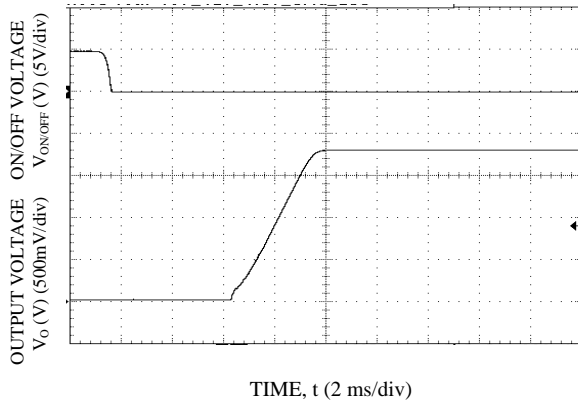

Figure 27. Start-up Using On/Off Voltage ($I_o = I_{o,max}$), $V_o = 1.8 V$

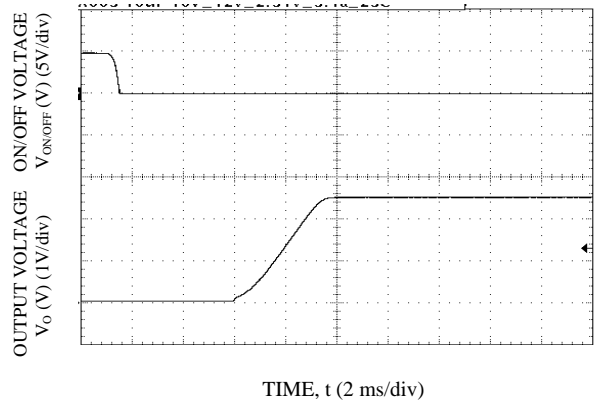

Figure 28. Start-up Using On/Off Voltage ($I_o = I_{o,max}$), $V_o = 2.5 V$

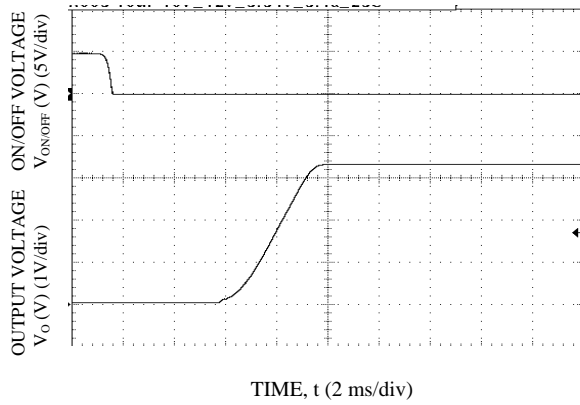

Figure 29. Start-up Using On/Off Voltage ($I_o = I_{o,max}$), $V_o = 3.3\text{ V}$

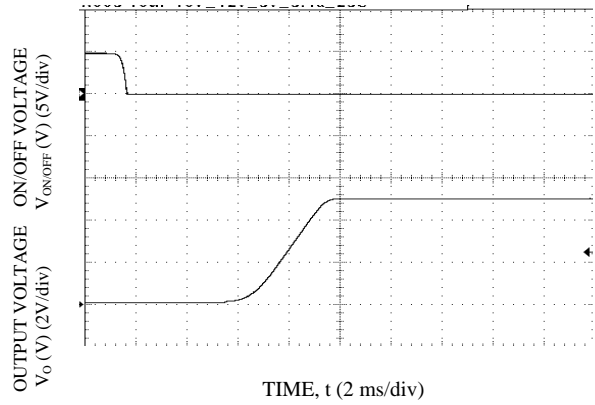

Figure 30. Start-up Using On/Off Voltage ($I_o = I_{o,max}$), $V_o = 5.0\text{ V}$

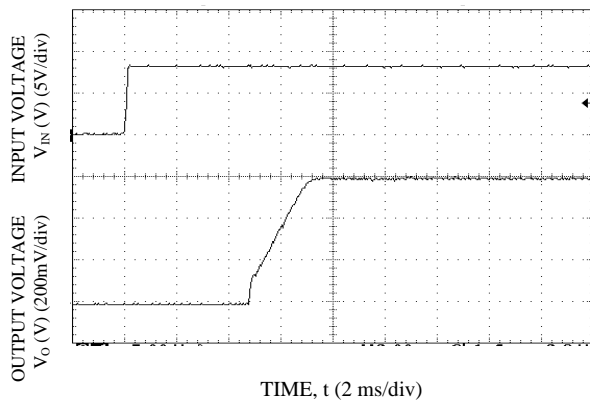

Figure 31. Start-up Using Input Voltage ($V_{IN} = 8\text{ V}$, $I_o = I_{o,max}$), $V_o = 0.6\text{ V}$

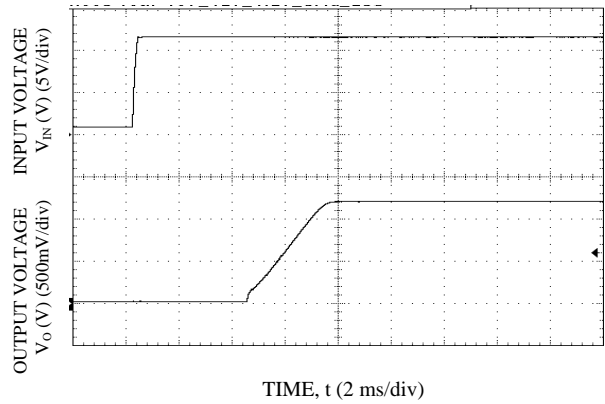

Figure 32. Start-up Using Input Voltage ($V_{IN} = 12\text{ V}$, $I_o = I_{o,max}$), $V_o = 1.2\text{ V}$

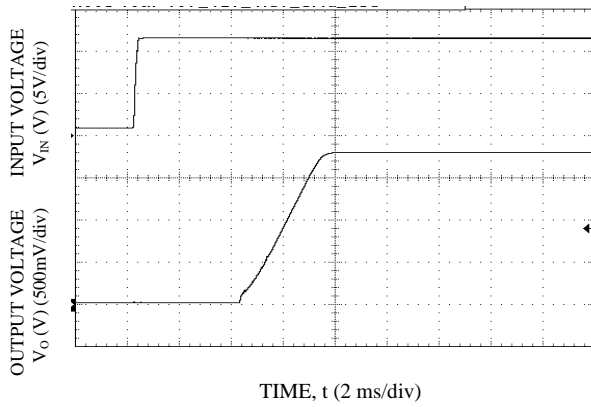

Figure 33. Start-up Using Input Voltage
($V_{IN} = 12\text{ V}$, $I_o = I_{o,max}$), $V_o = 1.8\text{ V}$

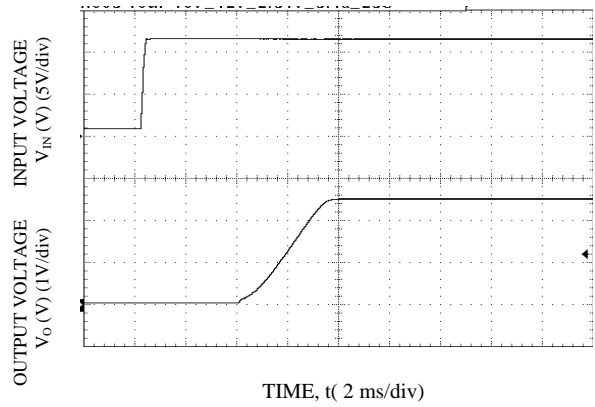

Figure 34. Start-up Using Input Voltage
($V_{IN} = 12\text{ V}$, $I_o = I_{o,max}$), $V_o = 2.5\text{ V}$

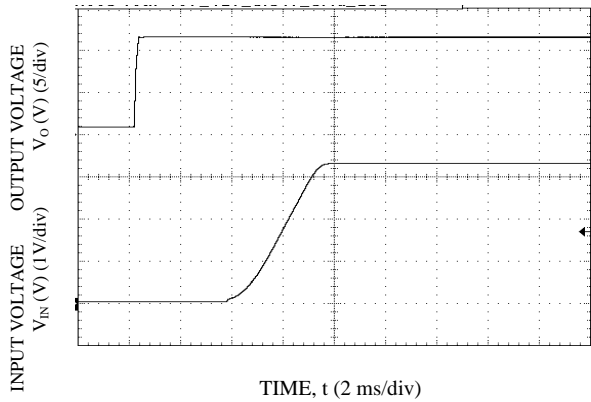

Figure 35. Start-up Using Input Voltage
($V_{IN} = 12\text{ V}$, $I_o = I_{o,max}$), $V_o = 3.3\text{ V}$

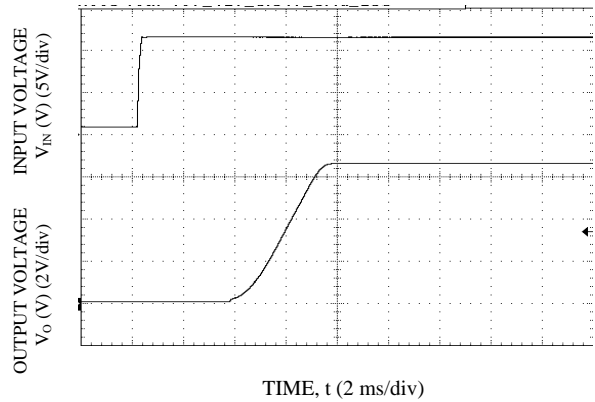

Figure 36. Start-up Using Input Voltage
($V_{IN} = 12\text{ V}$, $I_o = I_{o,max}$), $V_o = 5.0\text{ V}$

11. DESIGN CONSIDERATIONS

INPUT FILTERING

The SLAN-03D2Ax module should be connected to a low ac-impedance source. A highly inductive source can affect the stability of the module. An input capacitance must be placed directly adjacent to the input pin of the module, to minimize input ripple voltage and ensure module stability.

To minimize input voltage ripple, ceramic capacitors are recommended at the input of the module. Figure 37 shows the input ripple voltage for various output voltages at 3 A of load current with 1x22 μF or 2x22 μF ceramic capacitors and an input of 12 V.

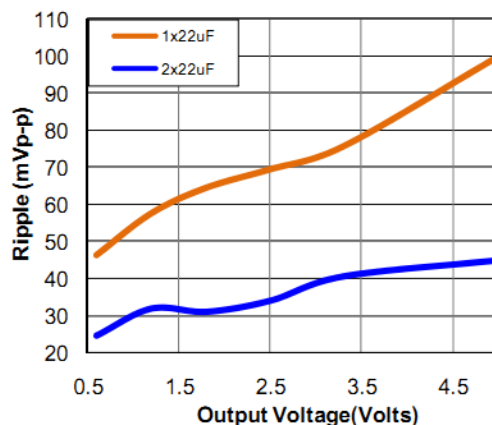

Figure 37.

Note: Input ripple voltage for various output voltages with 1x22 μF or 2x22 μF ceramic capacitors at the input (3 A load). Input voltage is 12 V.

OUTPUT FILTERING

These modules are designed for low output ripple voltage and will meet the maximum output ripple specification with 0.1 μF ceramic and 10 μF ceramic capacitors at the output of the module. However, additional output filtering may be required by the system designer for several reasons. First, there may be a need to further reduce the output ripple and noise of the module. Second, the dynamic response characteristics may need to be customized to a particular load step change.

To reduce the output ripple and improve the dynamic response to a step load change, additional capacitance at the output can be used. Low ESR polymer and ceramic capacitors are recommended to improve the dynamic response of the module. Figure 38 provides output ripple information for different external capacitance values at various V_o and a full load current of 3 A. For stable operation of the module, limit the capacitance to less than the maximum output capacitance as specified in the electrical specification table. Optimal performance of the module can be achieved by using the Tunable Loop™ feature described later in this data sheet.

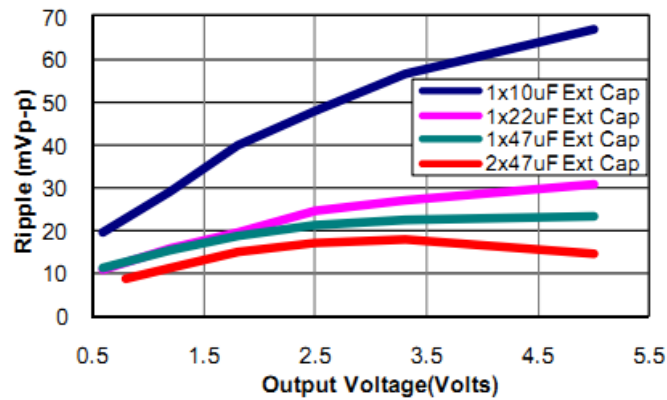

Figure 38.

Note: Output ripple voltage for various output voltages with external 1x10 μ F, 1x22 μ F, 1x47 μ F and 2x47 μ F ceramic capacitors at the output (3 A load). Input voltage is 12 V.

SAFETY CONSIDERATIONS

For safety agency approval the power module must be installed in compliance with the spacing and separation requirements of the end-use safety agency standards, i.e., IEC/EN 62368-1, UL/CSA 62368-1.

For the converter output to be considered meeting the requirements of electrical energy source class 1 (ES1), the input must meet ES1 requirements.

The input to these units is to be provided with a fast-acting fuse with a maximum rating of 5 A, 125 VDC in the positive input lead.

12. FEATURE DESCRIPTIONS

REMOTE ON/OFF

PARAMETER	DESCRIPTION	MIN	TYP	MAX	UNIT	
Signal Low (Unit On)	Active Low	Remote On/Off pin is open, the module is off	-0.2	-	0.4	V
Signal High (Unit Off)	Active Low	Remote On/Off pin is open, the module is off	3.0	-	V _{in,max}	V
Signal Low (Unit Off)	Active High	Remote On/Off pin is open, the module is on.	-0.2	-	0.3	V
Signal High (Unit On)	Active High	Remote On/Off pin is open, the module is on.	3.0	-	V _{in,max}	V

The SLAN-03D2Ax power modules feature an On/Off pin for remote On/Off operation. Two On/Off logic options are available. In the Positive Logic On/Off option, (device code suffix “0” – see Ordering Information), the module turns ON during a logic High on the On/Off pin and turns OFF during a logic Low. With the Negative Logic On/Off option, (device code suffix “L” – see Ordering Information), the module turns OFF during logic High and ON during logic Low. The On/Off signal should be always referenced to ground. For either On/Off logic option, leaving the On/Off pin disconnected will turn the module ON when input voltage is present.

For positive logic modules, the circuit configuration for using the On/Off pin is shown in Figure 39. When the external transistor Q1 is in the OFF state, the internal PWM Enable signal is pulled high through an internal resistor and the external pullup resistor and the module is ON. When transistor Q1 is turned ON, the On/Off pin is pulled low and the module is OFF. A suggested value for R_{pullup} is 20 kΩ.

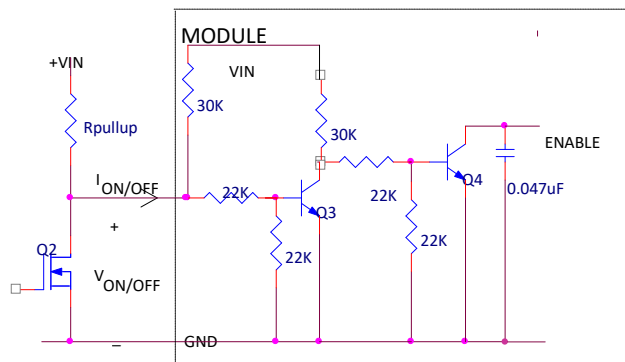

Figure 39. Circuit configuration for using positive On/Off logic

For negative logic On/Off modules, the circuit configuration is shown in Fig. 40. The On/Off pin should be pulled high with an external pull-up resistor (suggested value for the 3V to 14.4 V input range is 20 kΩ. When transistor Q1 is in the OFF state, the On/Off pin is pulled high, internal transistor Q4 is turned ON and the module is OFF. To turn the module ON, Q1 is turned ON pulling the On/Off pin low, turning transistor Q4 OFF resulting in the PWM Enable pin going high and the module turning ON.

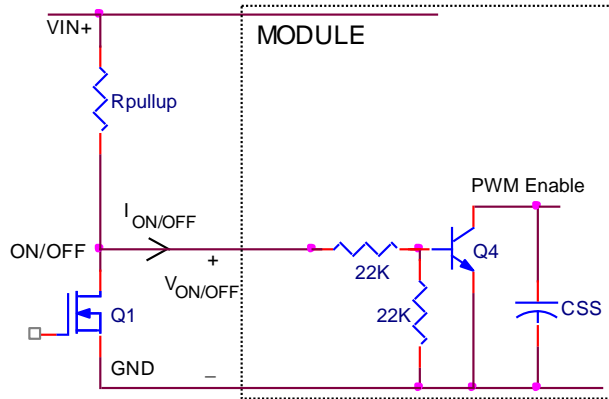

Figure 40. Circuit configuration for using negative On/Off logic

MONOTONIC START-UP AND SHUTDOWN

The SLAN-03D2Ax has monotonic start-up and shutdown behavior for any combination of rated input voltage, output current and operating temperature range.

STARTUP INTO PRE-BIASED OUTPUT

The SLAN-03D2Ax can start into a pre-biased output as long as the pre-bias voltage is 0.5 V less than the set output voltage.

OUTPUT VOLTAGE PROGRAMMING

The output voltage of the module is programmable to any voltage from 0.6 to 5.5 VDC by connecting a resistor between the Trim and GND pins of the module. Certain restrictions apply on the output voltage set point depending on the input voltage. These are shown in the Output Voltage vs. Input Voltage Set Point Area plot in Fig. 41. The Upper Limit curve shows that for output voltages lower than 1 V, the input voltage must be lower than the maximum of 12 V. The Lower Limit curve shows that for output voltages higher than 0.6 V, the input voltage needs to be larger than the minimum of 3 V.

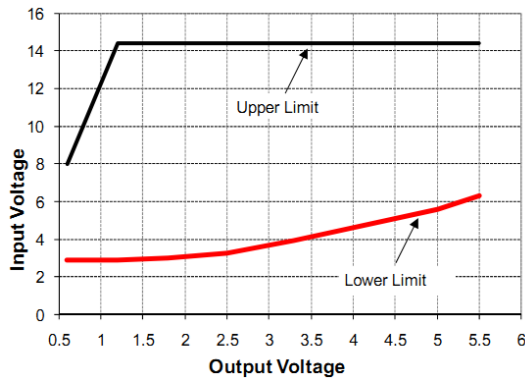

Figure 41.

Output Voltage vs. Input Voltage Set Point Area plot showing limits where the output voltage can be set for different input voltages.

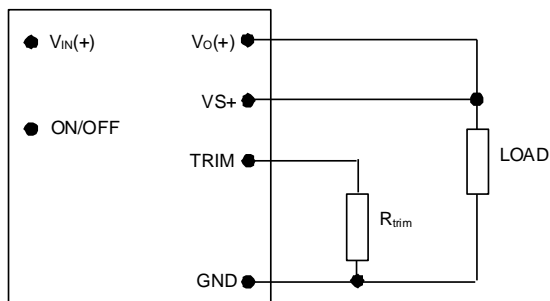

Figure 42. Circuit configuration for programming output voltage using an external resistor

Without an external resistor between Trim and GND pins, the output of the module will be 0.6 VDC. To calculate the value of the trim resistor, Rtrim for a desired output voltage, should be as per the following equation:

$$R_{trim} = \left[\frac{12}{(V_o - 0.6)} \right] k\Omega$$

Rtrim is the external resistor in kΩ
 Vo is the desired output voltage.

Table1

V _{O, set} (V)	R _{trim} (KΩ)
0.6	Open
0.9	40
1.0	30
1.2	20
1.5	13.33
1.8	10
2.5	6.316
3.3	4.444
5.0	2.727

REMOTE SENSE

The power module has a Remote Sense feature to minimize the effects of distribution losses by regulating the voltage at the SENSE pin. The voltage between the SENSE pin and VOUT pin should not exceed 0.5 V.

VOLTAGE MARGINING

Output voltage margining can be implemented in the module by connecting a resistor, Rmargin-up, from the Trim pin to the ground pin for margining-up the output voltage and by connecting a resistor, Rmargin-down, from the Trim pin to output pin for margining-down. Figure 43 shows the circuit configuration for output voltage margining. Please consult your local Bel Power technical representative for additional details.

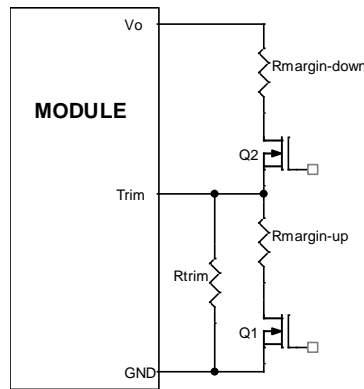

Figure 43. Circuit Configuration for margining Output voltage

OVER CURRENT PROTECTION

To provide protection in a fault (output overload) condition, the unit is equipped with internal current limiting circuitry and can endure current limiting continuously. At the point of current limit inception, the unit enters hiccup mode. The unit operates normally once the output current is brought back into its specified range.

OVER TEMPERATURE PROTECTION

To provide protection in a fault condition, the unit is equipped with a thermal shutdown circuit. The unit will shut down if the overtemperature threshold of 135°C (typ) is exceeded at the thermal reference point T_{ref} . Once the unit goes into thermal shutdown it will then wait to cool before attempting to restart.

INPUT UNDERVOLTAGE LOCKOUT

At input voltages below the input undervoltage lockout limit, the module operation is disabled. The module will begin to operate at an input voltage above the undervoltage lockout turn-on threshold.

POWER GOOD

The SLAN-03D2Ax provides a Power Good (PGOOD) signal that is implemented with an open-drain output to indicate that the output voltage is within the regulation limits of the power module. The PGOOD signal will be de-asserted to a low state if any condition such as overtemperature, overcurrent or loss of regulation occurs that would result in the output voltage going $\pm 10\%$ outside the setpoint value. The PGOOD terminal can be connected through a pullup resistor (suggested value 100 k Ω) to a source of 5 VDC or lower.

DUAL LAYOUT

Identical dimensions and pin layout of Analog and Digital modules permit migration from one to the other without needing to change the layout. To support this, 2 separate Trim Resistor locations have to be provided in the layout. For the digital modules, the resistor is connected between the TRIM pad and SGND and in the case of the analog module it is connected between TRIM and GND.

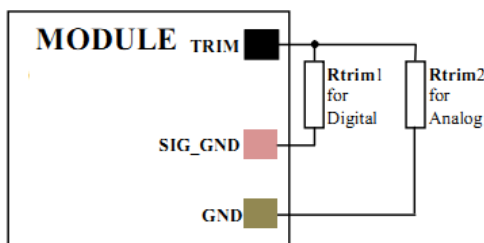

Figure 44.

Caution – Do not connect SIG_GND to GND elsewhere in the layout
Layout to support either Analog or Digital on the same pad.

TUNABLE LOOP™

The SLAN-03D2Ax modules have a feature that optimizes transient response of the module called Tunable Loop™

External capacitors are usually added to the output of the module for two reasons: to reduce output ripple and noise (see Figure 38) and to reduce output voltage deviations from the steady-state value in the presence of dynamic load current changes. Adding external capacitance however affects the voltage control loop of the module, typically causing the loop to slow down with sluggish response. Larger values of external capacitance could also cause the module to become unstable.

The Tunable Loop™ allows the user to externally adjust the voltage control loop to match the filter network connected to the output of the module. The Tunable Loop™ is implemented by connecting a series R-C between the SENSE and TRIM pins of the module, as shown in Fig. 45. This R-C allows the user to externally adjust the voltage loop feedback compensation of the module.

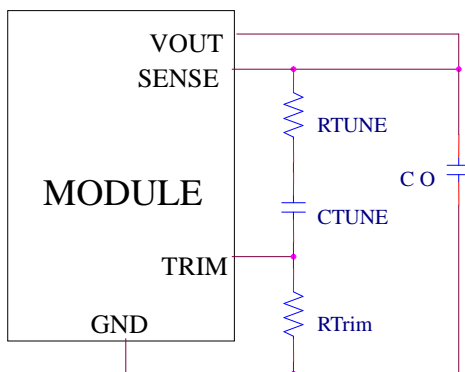

Figure 45. Circuit diagram showing connection of R_{TUNE} and C_{TUNE} to tune the control loop of the module

Recommended values of R_{TUNE} and C_{TUNE} for different output capacitor combinations are given in Tables 2 and 3. Table 2 shows the recommended values of R_{TUNE} and C_{TUNE} for different values of ceramic output capacitors up to 1000 μ F that might be needed for an application to meet output ripple and noise requirements. Selecting R_{TUNE} and C_{TUNE} according to Table 2 will ensure stable operation of the module.

In applications with tight output voltage limits in the presence of dynamic current loading, additional output capacitance will be required. Table 3 lists recommended values of R_{TUNE} and C_{TUNE} in order to meet 2% output voltage deviation limits for some common output voltages in the presence of a 1.5 to 3 A step change (50% of full load), with an input voltage of 12 V.

Please contact your Bel Power technical representative to obtain more details of this feature as well as for guidelines on how to select the right value of external R-C to tune the module for best transient performance and stable operation for other output capacitance values or input voltages other than 12 V.

Table 2

Co	1x47 μ F	2x47 μ F	4x47 μ F	6x47 μ F	10x47 μ F
R _{TUNE}	270 Ω	220 Ω	180 Ω	180 Ω	180 Ω
C _{TUNE}	1500 pF	1800 pF	3300 pF	4700 pF	4700 pF

General recommended values of R_{TUNE} and C_{TUNE} for Vin=12 V and various external ceramic capacitor combinations.

Table 3

Vo	5 V	3.3 V	2.5 V	1.8 V	1.2 V	0.6 V
Co	1x47 μ F	1x47 μ F	2x47 μ F	1x330 μ F Polymer	1x330 μ F Polymer	2x330 μ F Polymer
R _{TUNE}	270 Ω	220 Ω	180 Ω	180 Ω	180 Ω	180 Ω
C _{TUNE}	1500 pF	1800 pF	3300 pF	8200 pF	8200 pF	33 nF
Δ V	68 mV	60 mV	37 mV	18 mV	18 mV	10 mV

Recommended values of R_{TUNE} and C_{TUNE} to obtain transient deviation of 2% of Vout for a 1.5 A step load with Vin=12 V.

Note: The capacitors used in the Tunable Loop tables are 47 μ F/3 m Ω ESR ceramic and 330 μ F/12 m Ω ESR polymer capacitors.

13. THERMAL CONSIDERATION

Power modules operate in a variety of thermal environments; however, sufficient cooling should always be provided to help ensure reliable operation.

Considerations include ambient temperature, airflow, module power dissipation, and the need for increased reliability. A reduction in the operating temperature of the module will result in an increase in reliability. The thermal data presented here is based on physical measurements taken in a wind tunnel. The test set-up is shown in Figure 46. The preferred airflow direction for the module is in Figure 47.

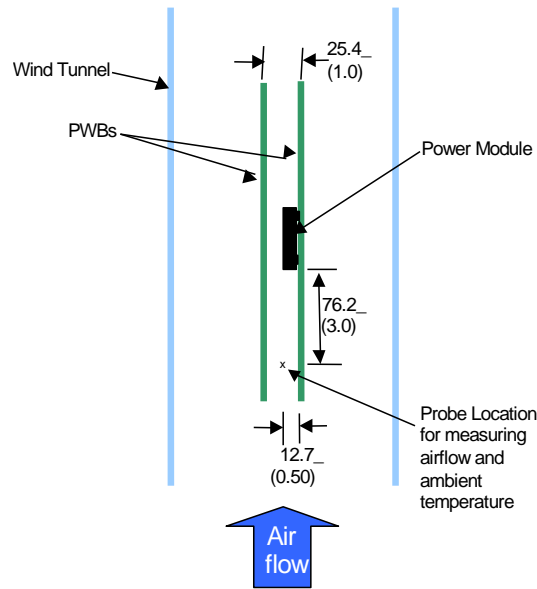

Figure 46. Thermal Test Setup

The thermal reference points, Tref used in the specifications are also shown in Figure 47. For reliable operation the temperatures at these points should not exceed 120°C. The output power of the module should not exceed the rated power of the module (Vo,set x Io,max).

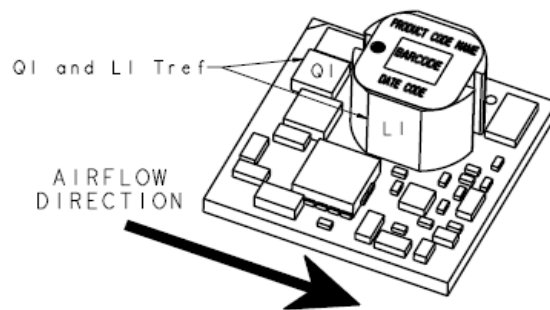

Figure 47. Preferred airflow direction and location of hot spot of the module (Tref)

14. EXAMPLE APPLICATION CIRCUIT

Requirements:

Vin:	12 V
Vout:	1.8 V
Iout:	2.25 A max., worst case load transient is from 1.5 A to 2.25 A
ΔV_{out} :	1.5% of Vout (27 mV) for worst case load transient
Vin, ripple:	1.5% of Vin (180 mV, p-p)

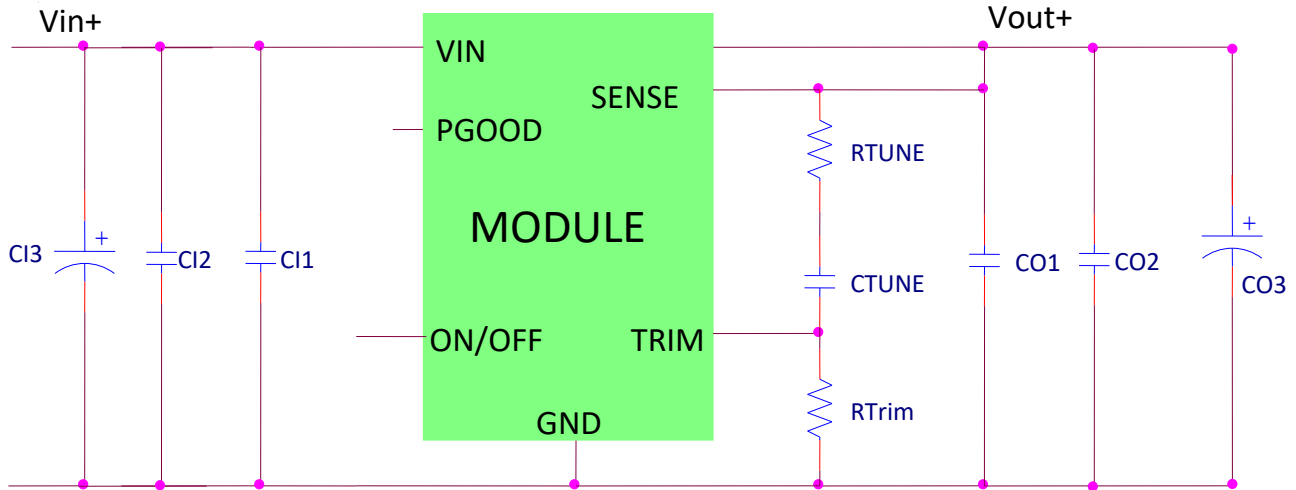

Figure 48.

C11	Decoupling cap - 1x0.047 μ F/16 V ceramic capacitor (e.g. Murata LLL185R71C473MA01)
C12	1x22 μ F/16 V ceramic capacitor (e.g. Murata GRM32ER61C226KE20 or equivalent)
C13	47 μ F/16 V bulk electrolytic
CO1	Decoupling cap - 1x0.047 μ F/16 V ceramic capacitor (e.g. Murata LLL185R71C473MA01)
CO2	2x47 μ F/6.3 V ceramic capacitor (e.g. Murata GRM31CR60J476ME19 or equivalent)
CO3	None
CTune	2200 pF ceramic capacitor (can be 1206, 0805 or 0603 size)
RTune	261 Ω SMT resistor (can be 1206, 0805 or 0603 size)
RTrim	10 k Ω SMT resistor (can be 1206, 0805 or 0603 size, recommended tolerance of 0.1%)

15. MECHANICAL OUTLINE

Dimensions are in millimeters and (inches).

Tolerances: $x.x \text{ mm} \pm 0.5 \text{ mm}$ ($x.xx \text{ in.} \pm 0.02 \text{ in.}$) [unless otherwise indicated]

$x.xx \text{ mm} \pm 0.25 \text{ mm}$ ($x.xxx \text{ in.} \pm 0.010 \text{ in.}$)

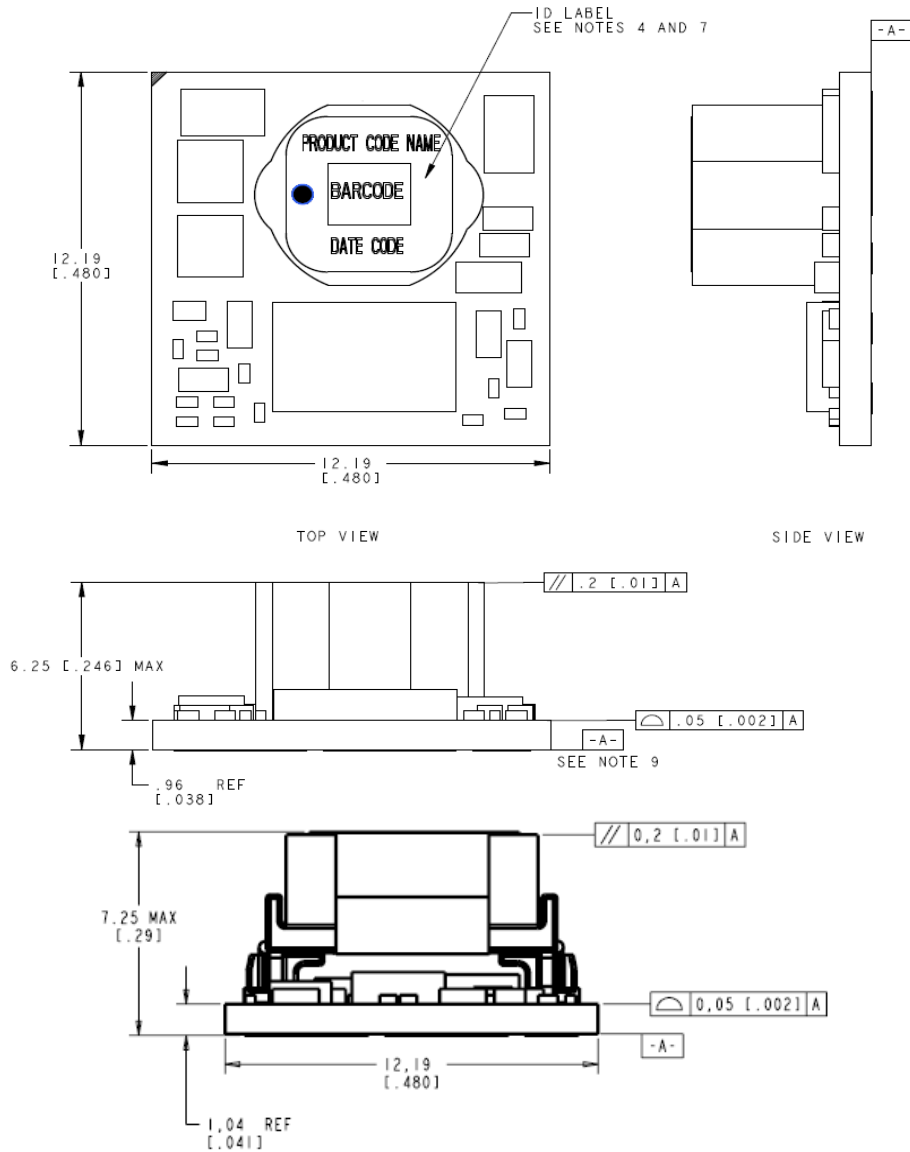

Figure 49.

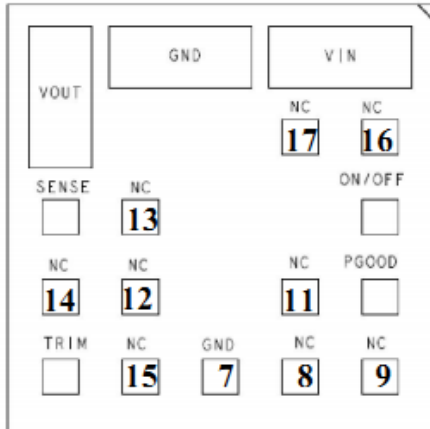

Figure 50. Pins

PIN	FUNCTION	PIN	FUNCTION
1	ON/OFF	10	PGOOD
2	VIN	11	NC
3	GND	12	NC
4	VOUT	13	NC
5	VS+ (SENSE)	14	NC
6	TRIM	15	NC
7	GND	16	NC
8	NC	17	NC
9	NC		

16. RECOMMENDED PAD LAYOUT

Dimensions are in millimeters and (inches).

Tolerances: x.x mm ± 0.5 mm (x.xx in. ± 0.02 in.) [unless otherwise indicated]

x.xx mm ± 0.25 mm (x.xxx in ± 0.010 in.)

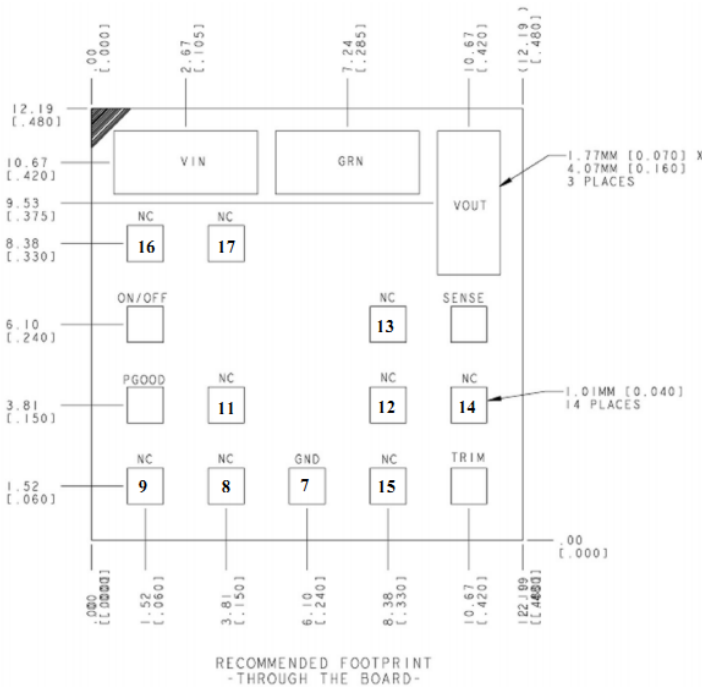

Figure 51. Recommended pad layout

PIN	FUNCTION	PIN	FUNCTION
1	ON/OFF	10	PGOOD
2	VIN	11	NC
3	GND	12	NC
4	VOUT	13	NC
5	VS+ (SENSE)	14	NC
6	TRIM	15	NC
7	GND	16	NC
8	NC	17	NC
9	NC		

17. RECOMMENDED PAD LAYOUT

The SLAN-03D2Ax modules are supplied in tape & reel as standard.
All Dimensions are in millimeter [inch].

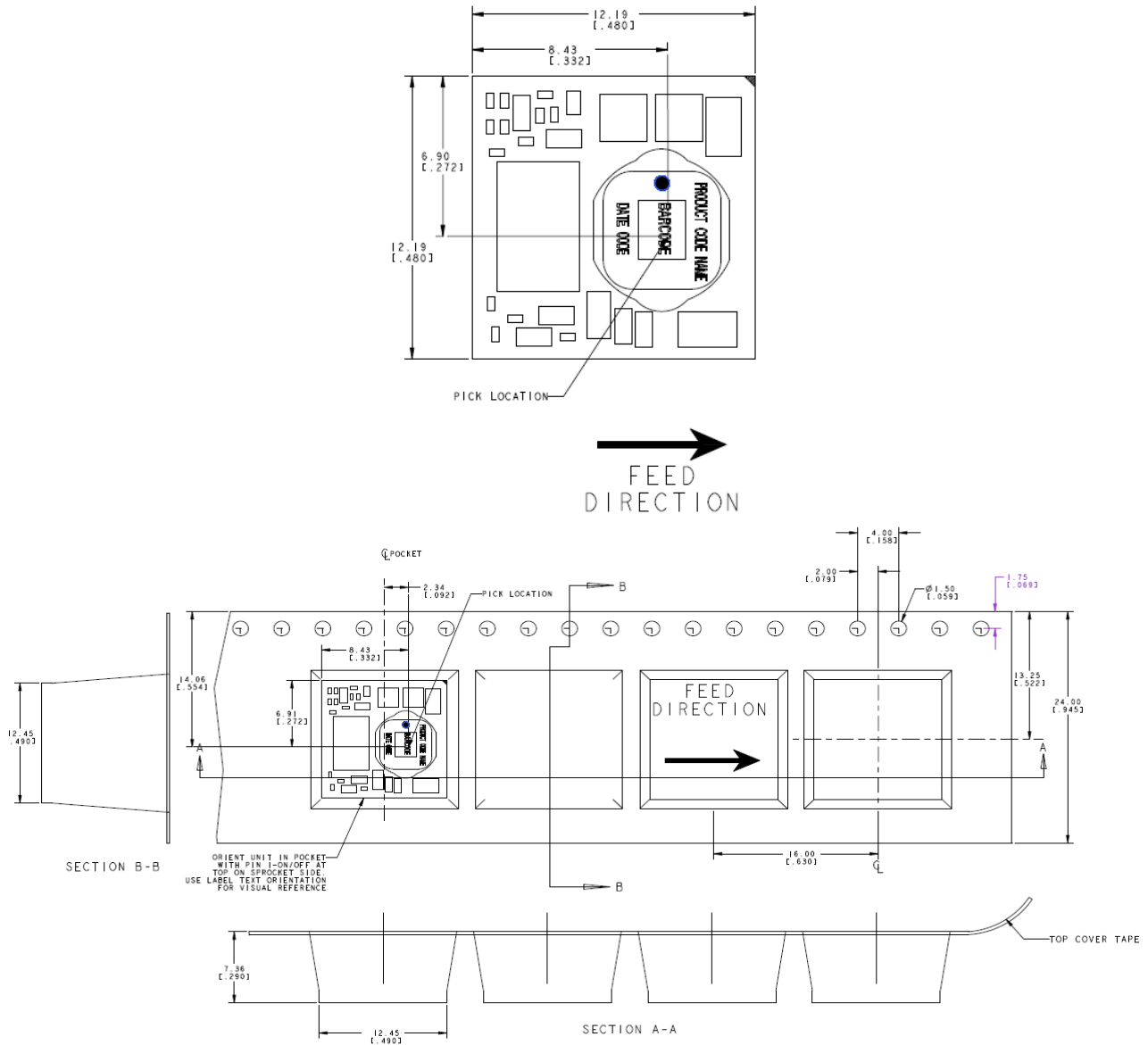

Figure 52.

- Reel Dimensions:
- Outside Dimensions: 330.2 mm (13.00")
- Inside Dimensions: 177.8 mm (7.00")
- Tape Width: 24.00 mm (0.945")



Asia-Pacific
+86 755 298 85888

Europe, Middle East
+353 61 49 8941

North America
+1 866 513 2839

18. SURFACE MOUNT INFORMATION

PICK AND PLACE

The SLAN-03D2Ax modules use an open frame construction and are designed for a fully automated assembly process. The modules are fitted with a label designed to provide a large surface area for pick and place operations. The label meets all the requirements for surface mount processing, as well as safety standards, and is able to withstand reflow temperatures of up to 300°C. The label also carries product information such as product code, serial number and the location of manufacture.

NOZZLE RECOMMENDATIONS

The weight has been kept to a minimum by using open frame construction. Variables such as nozzle size, tip style, vacuum pressure and placement speed should be considered to optimize this process. The minimum recommended inside nozzle diameter for reliable operation is 3mm. The maximum nozzle outer diameter, which will safely fit within the allowable component spacing, is 7 mm.

BOTTOM SIDE / FIRST SIDE ASSEMBLY

This module is not recommended for assembly on the bottom side of a customer board. If such an assembly is attempted, components may fall off the module during the second reflow process.

LEAD FREE SOLDERING

The SLAN-03D2Ax modules are lead-free (Pb-free) and RoHS compliant and are both forward and backward compatible in a Pb-free and a SnPb soldering process. Failure to observe the instructions below may result in the failure of or cause damage to the modules and can adversely affect long-term reliability.

PB-FREE REFLOW PROFILE

Power Systems will comply with J-STD-020 Rev. C (Moisture/Reflow Sensitivity Classification for Nonhermetic Solid State Surface Mount Devices) for both Pb-free solder profiles and MSL classification procedures. This standard provides a recommended forced-air-convection reflow profile based on the volume and thickness of the package (table 5-2). The suggested Pb-free solder paste is Sn/Ag/Cu (SAC). For questions regarding LGA, solder volume; please contact Bel Power for special manufacturing process instructions.

The recommended linear reflow profile using Sn/Ag/Cu solder is shown in Fig. 53. Soldering outside of the recommended profile requires testing to verify results and performance.

It is recommended that the pad layout include a test pad where the output pin is in the ground plane. The thermocouple should be attached to this test pad since this will be the coolest solder joints. The temperature of this point should be:

Maximum peak temperature is 260 °C.

Minimum temperature is 235 °C.

Dwell time above 217 °C: 60 seconds minimum.

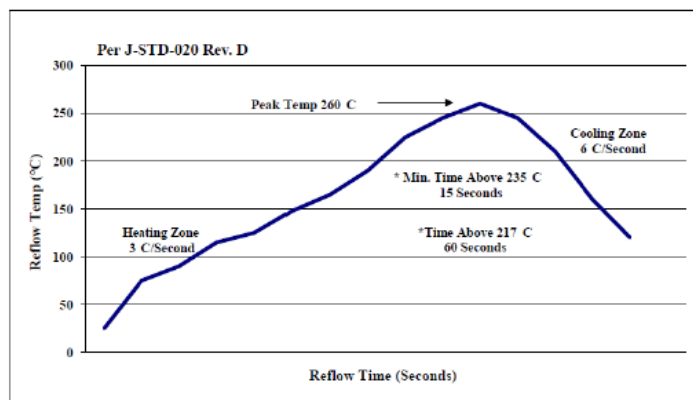

Figure 53. Recommended linear reflow profile using Sn/Ag/Cu solder

MSL RATING

The SLAN-03D2Ax modules have a MSL rating of 2 A.

STORAGE AND HANDLING

The recommended storage environment and handling procedures for moisture-sensitive surface mount packages is detailed in J-STD-033 Rev. B (Handling, Packing, Shipping and Use of Moisture/Reflow Sensitive Surface Mount Devices). Moisture barrier bags (MBB) with desiccant are required for MSL ratings of 2 or greater. These sealed packages should not be broken until time of use. Once the original package is broken, the floor life of the product at conditions of ≤ 30°C and 60% relative humidity varies according to the MSL rating (see J-STD-033A). The shelf life for dry packed SMT packages will be a minimum of 12 months from the bag seal date, when stored at the following conditions: < 40°C, < 90% relative humidity.

POST SOLDER CLEANING AND DRYING CONSIDERATIONS

Post solder cleaning is usually the final circuit board assembly process prior to electrical board testing. The result of inadequate cleaning and drying can affect both the reliability of a power module and the testability of the finished circuit board assembly. For guidance on appropriate soldering, cleaning and drying procedures, refer to Board Mounted Power Modules: Soldering and Cleaning Application Note (AN04-001).



Asia-Pacific
+86 755 298 85888

Europe, Middle East
+353 61 49 8941

North America
+1 866 513 2839

19. REVISION HISTORY

DATE	REVISION	CHANGES DETAIL	APPROVAL
2012-03-20	A	First release.	HL.Lu
2015-7-13	B	Update part selection, absolute maximum ratings, Input specifications, output specifications, general specifications, transient response waveforms, safety considerations, remote on/off, voltage margining, over temperature protection, example application circuit, MSL rating and packaging details.	XF.Jiang
2021-07-21	AC	Add object ID and module photo. Update safety certificate and altitude. Update to new format.	XF.Jiang

For more information on these products consult: tech.support@psbel.com

NUCLEAR AND MEDICAL APPLICATIONS - Products are not designed or intended for use as critical components in life support systems, equipment used in hazardous environments, or nuclear control systems.

TECHNICAL REVISIONS - The appearance of products, including safety agency certifications pictured on labels, may change depending on the date manufactured. Specifications are subject to change without notice.



tech.support@psbel.com
belfuse.com/power-solutions

Looking for pricing, stock, or lifecycle information?

Click below to explore more details on WIN SOURCE:

 [View SLAN-03D2ALG on WIN SOURCE](#)

 [Bel Fuse Inc. Information](#)

Optimize Your Supply Chain with WIN SOURCE Solutions

-  Global Sourcing Solution
-  Obsolete Management
-  Cost Control Management
-  Shortage Management
-  Alternative Solution
-  Excess Inventory Management