



# THE DATASHEET OF ESL-51BNC-H



Jiangsu Everstar Electronics Co., Ltd.

**Address:**No.6 Xiangshan Rd, Tianmuhu Industry Park, Liyang City, Jiangsu Province, China

**TEL:** +86-519-87557772

**FAX:** +86-519-87557773

**Http:** [www.everstarelect.com](http://www.everstarelect.com)

## DATA SHEET

ESL NO.. : ESL-51BNC-H

CUS NO. :

REV : A / 0

Producer: 张书艺

Auditor: \_\_\_\_\_

Approver: 储志华

CUSTOMER'S APPROVAL : \_\_\_\_\_

DCC : \_\_\_\_\_



# 5.0 mm Infrared Emitting Diode

**ESL-51BNC-H**

REV:A /0

## FEATURES

- \* 5.0 mm Infrared Emitting Diode      \* High reliability
- \* Low operating voltage                      \* Low power consumption, long life
- \* PB Free products (Compliant with EU's RoHS)

## CHIP MATERIALS:

- \* Dice Material : GaAlAs                      \* Light Color: Colourless
- \* Lens Color: Pink Transparent

## ABSOLUTE MAXIMUM RATING : ( Ta = 25°C )

Symbol	Parameter	Rated	Unit
IFM	Forward Current	100	mA
IFPM	Pulse Forward Current	1	A
VR	Reverse Voltage	5	V
PM	Power Consumption	150	mw
Top	Operating Temperature Range	- 40~85	° C
Tstg	Storage Temperature Range	- 40~100	° C

\* Positive pulse current (Duty-0.1,1KHZ)

SYMBOL	PARAMETER	TEST CONDITION	MIN.	TYP.	MAX.	UNIT
VF	Forward Voltage	IF = 20mA	1.2		1.5	V
		IF = 100mA	1.4		1.8	
IR	Reverse Current	VR = 5V			10	µA
2θ1/2	Half Intensity Angle	IF = 20mA		20		deg
IE	Axial Radiand Intensity	IF = 20mA		20		mW/sr
		IF = 100mA		75		
λD	Dominant Wavelength	IF=20mA	870		890	nm
tr	Rise time	Vr=5V		40		ms
tf	Fall time	Ee=1mW/cm <sup>2</sup> RL=1000Ω		40		

## ELECTRO-OPTICAL CHARACTERISTICS : ( Ta = 25°C )



# 5.0 mm Infrared Emitting Diode

## ESL-51BNC-H

REV:A /0

Forward Current vs. Ambient Temperature

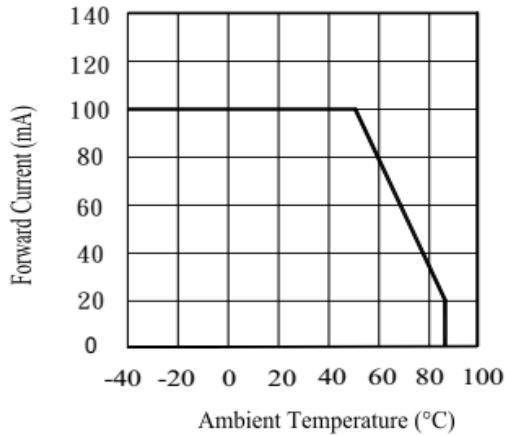

Spectral Distribution

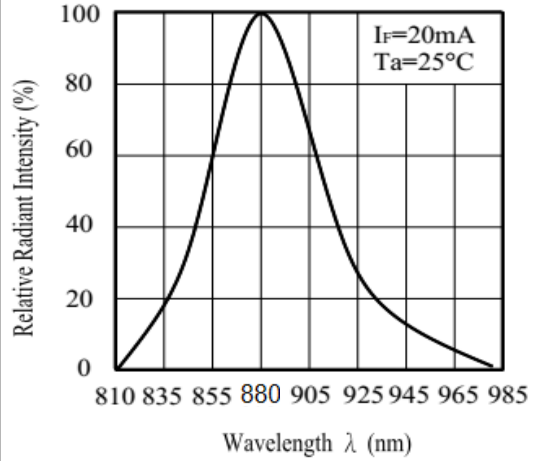

Peak Emission Wavelength vs. Ambient Temperature

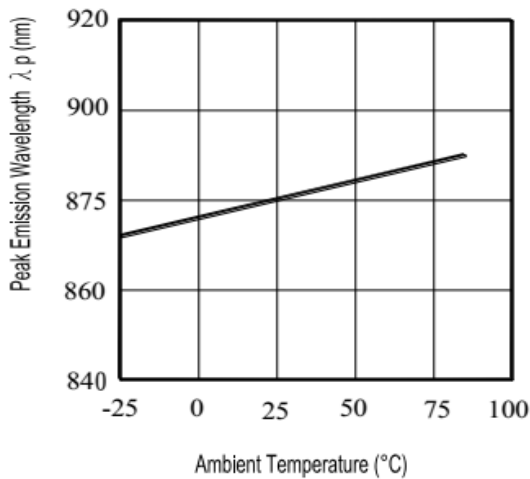

Forward Current vs. Forward Voltage

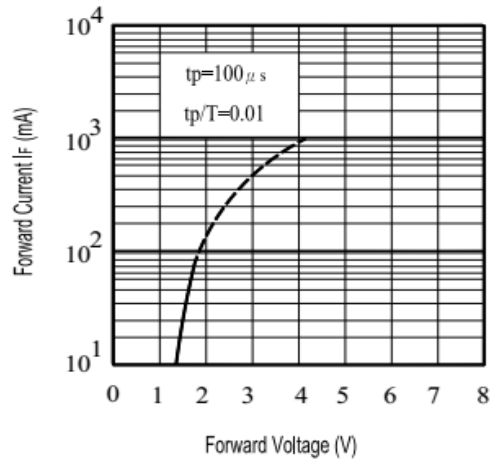

Radiant Intensity vs. Forward Current

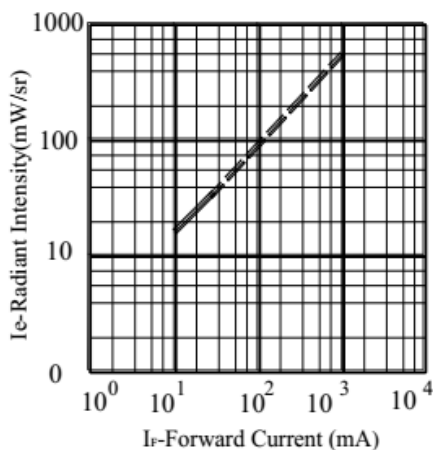

Relative Radiant Intensity vs. Angular Displacement

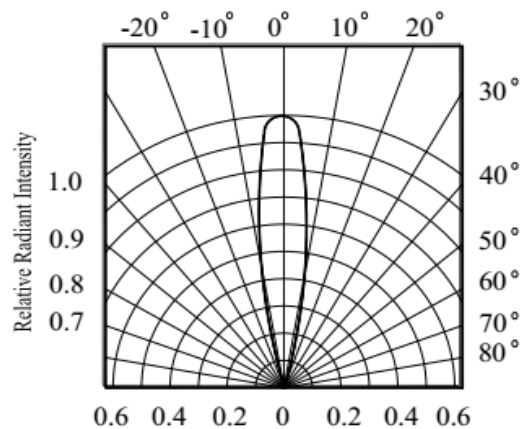

# 5.0 mm Infrared Emitting Diode

ESL-51BNC-H

REV:A /0

## •SOLDERING

METHOD	SOLDERING CONDITIONS	REMARK
DIP SOLDERING	Bath temperature: 260°C Immersion time: with 5 sec ,1times	<ul style="list-style-type: none"> <li>• Solder no closer than 3mm from the base of the package</li> <li>• Using soldering flux," RESIN FLUX" is recommended.</li> </ul>
SOLDERING IRON	Soldering iron: 30W or smaller Temperature at tip of iron: 400°C or lower Soldering time: within 3 sec.	<ul style="list-style-type: none"> <li>• During soldering, take care not to press the tip of iron against the lead.</li> </ul> <p>(To prevent heat from being transferred directly to the lead, hold the lead with a pair of tweezers while soldering</p>

- 1) When soldering the lead of LED in a condition that the package is fixed with a panel (See Fig.1), be careful not to stress the leads with iron tip.

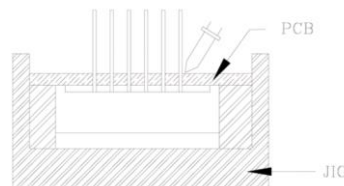

Fig.1

- 2) When soldering wire to the lead, work with a jig (See Fig.2) to avoid stressing the package.

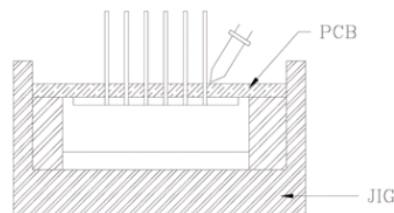

Fig.2

Regarding solution in the tinning oven for product-tinning, compound sub-solution made of tin & copper and silver is proposed with the temperature of Celsius 260. The proportion of the alloyed solution is tin 95.5: copper 3.5: silver 0.5 by percentage. The time of tinning is constantly 3 seconds.

## 5.0 mm Infrared Emitting Diode

ESL-51BNC-H

REV:A /0

- 3) Similarly, when a jig is used to solder the LED to PC board, take care as much as possible to avoid steering the leads (See Fig.3).

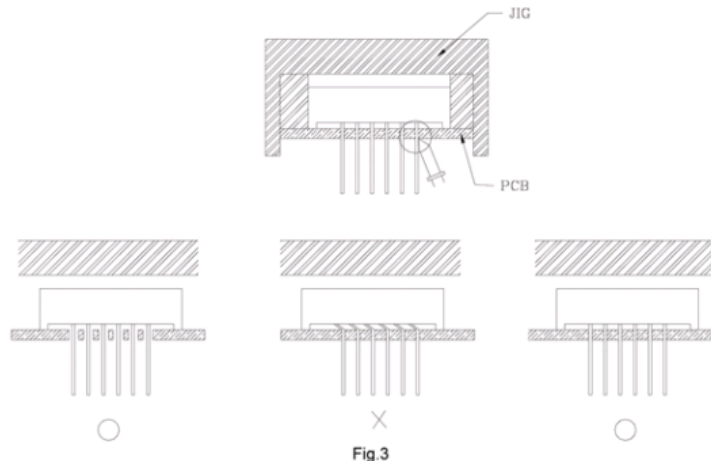

- 4) Repositioning after soldering should be avoided as much as possible. If inevitable, be sure to preserve the soldering conditions with irons stated above: select a best-suited method that assures the least stress to the LED.
- 5) Lead cutting after soldering should be performed only after the LED temperature has returned to normal temperature.

### • STORAGE

- 1) The LEDs should be stored at 30°C or less and 70% RH or less after being shipped from PARA and the storage life limit is 1 year.
- 2) EVERSTAR LED lead frames are comprised of a stannum plated iron alloy. The silver surface may be affected by environments which contain corrosive gases and so on. Please avoid conditions which may cause the LEDs to corrode, tarnish or discolor. This corrosion or discoloration may cause difficulty during soldering operations. It is recommended that the LEDs be used as soon as possible.
- 3) Please avoid rapid transitions in ambient temperature, especially, in high humidity environments where condensation can occur.

### •LED MOUNTING METHOD

- 4) When mounting the LED by using a case, as shown Fig.4, ensure that the mounting holds on the PC board match the pitch of the leads correctly-tolerance of dimensions of the respective components including the LED should be taken into account especially when designing the case, PC board, etc. to prevent pitch misalignment between the leads and board holes, the diameter of the board holes should be slightly larger than the size of the lead. Alternatively, the shape of the holes should be made oval. (See Fig.4)

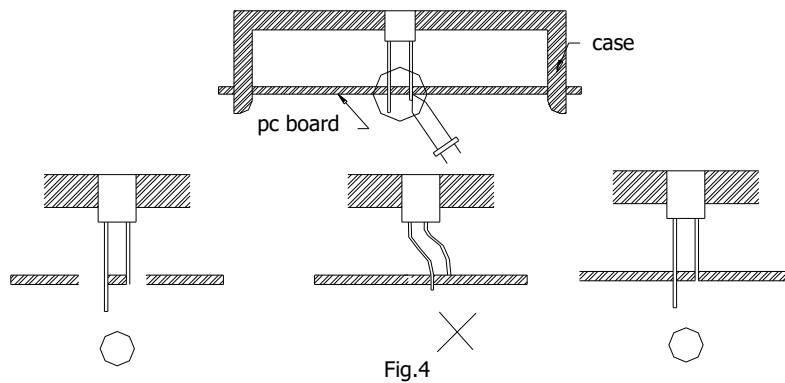

- 5) Use LEDs with stand-off (Fig.5) or the tube or spacer made of resin (Fig.6) to position the LEDs.

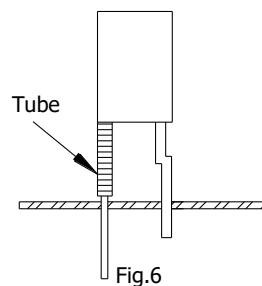
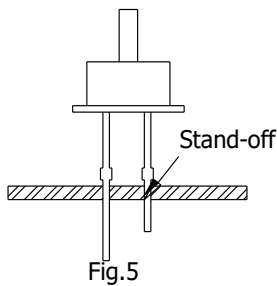

### •FORMED LEAD

- 1) The lead should be bent at a point located at least 2mm away from the package. Bending should be performed with base fixed means of a jig or pliers (Fig.7)

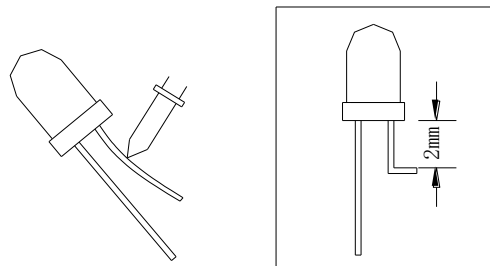

Fig. 7

- 2) Forming lead should be carried out prior to soldering and never during or after soldering.
- 3) Form the lead to ensure alignment between the leads and the hole on board, so that stress against the LED is prevented. (Fig.8)

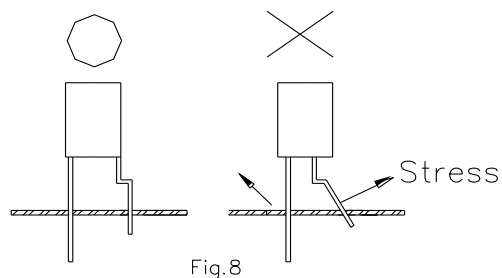

Fig.8

### •LEAD STRENGTH

- 1) Bend strength  
Do not bend the lead more than twice. (Fig.9)

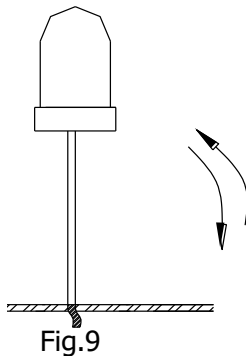

Fig.9

2) Tensile strength (@Room Temperature)

If the force is 1kg or less, there will be no problem. (Fig.10)



### • HEAT GENERATION

- 1) Thermal design of the end product is of paramount importance. Please consider the heat generation of the LED when making the system design. The coefficient of temperature increase per input electric power is affected by the thermal resistance of the circuit board and density of LED placement on the board, as well as other components. It is necessary to avoid intense heat generation and operate within the maximum ratings given in this specification.

The operating current should be decided after considering the ambient maximum temperature of LEDs.

### •CHEMICAL RESISTANCE

- ① Avoid exposure to chemicals as it may attack the LED surface and cause discoloration.
- ② When washing is required, refer to the following table for the proper chemical to be used.  
(Immersion time: within 3 minutes at room temperature.)

SOLVENT	ADAPTABILITY
Freon TE	⊙
Chloroethene	×
Isopropyl Alcohol	⊙
Thinner	×
Acetone	×
Trichloroethylene	×

⊙--Usable    ×--Do not use.

NOTE: Influences of ultrasonic cleaning of the LED resin body differ depending on such factors as the oscillator output, size of the PC board and the way in which the LED is mounted. Therefore, ultrasonic cleaning should only be performed after confirming there is no problem by conducting a test under practical.



## 5.0 mm Infrared Emitting Diode

ESL-51BNC-H

REV:A/0

### •OTHERS

- ① Care must be taken to ensure that the reverse voltage will not exceed the absolute maximum rating when using the LEDs with matrix drive.
- ② Flashing lights have been known to cause discomfort in people; you can prevent this by taking precautions during use. Also, people should be cautious when using equipment that has had LEDs incorporated into it.
- ③ The LEDs described in this brochure are intended to be used for ordinary electronic equipment (such as office equipment, communications equipment, measurement instruments and household appliances). Consult EVERSTAR's sales staff in advance for information on the applications in which exceptional quality and reliability are required, particularly when the failure or malfunction of the LEDs may directly jeopardize life or health (such as for airplanes, aerospace, submersible repeaters, nuclear reactor control systems, automobiles, traffic control equipment, life support systems and safety devices).
- ④ User shall not reverse engineer by disassembling or analysis of the LEDs without having prior written consent from EVERSTAR. When defective LEDs are found, the User shall inform EVERSTAR directly before disassembling or analysis.
- ⑤ The formal specifications must be exchanged and signed by both parties before large volume purchase begins.
- ⑥ The appearance and specifications of the product may be modified for improvement without notice.

## Looking for pricing, stock, or lifecycle information?

Click below to explore more details on WIN SOURCE:

- [View ESL-51BNC-H on WIN SOURCE](#)
- [Shanghai Everstar Electronics Co., Ltd. Information](#)

## Optimize Your Supply Chain with WIN SOURCE Solutions

- ✓ Global Sourcing Solution
- ✓ Obsolete Management
- ✓ Cost Control Management
- ✓ Shortage Management
- ✓ Alternative Solution
- ✓ Excess Inventory Management