



# THE DATASHEET OF ESD-SQ1X1001D24D



Jiangsu Everstar Electronics Co., Ltd.

**Address:**No.6, Xiangshan Rd, Tianmuhu Town,Liyang City,Jiangsu,213300

**TEL:** +86-519-87557772

**FAX:** +86-519-87557773

**Http:** [www.everstarelect.com](http://www.everstarelect.com)

## DATA SHEET

ESL NO.. : ESD-SQ1X1001D24D

CUS NO. :

REV : A / 0

Producer: Eden

Auditor: \_\_\_\_\_

Approver: Jack

CUSTOMER'S APPROVAL : \_\_\_\_\_

DCC : \_\_\_\_\_

■ PACKAGE DIMENSIONS

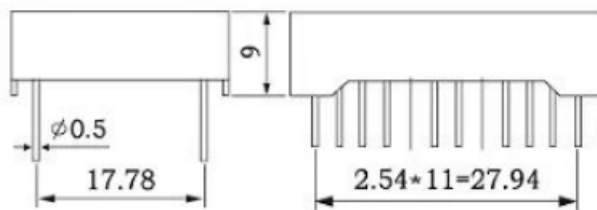
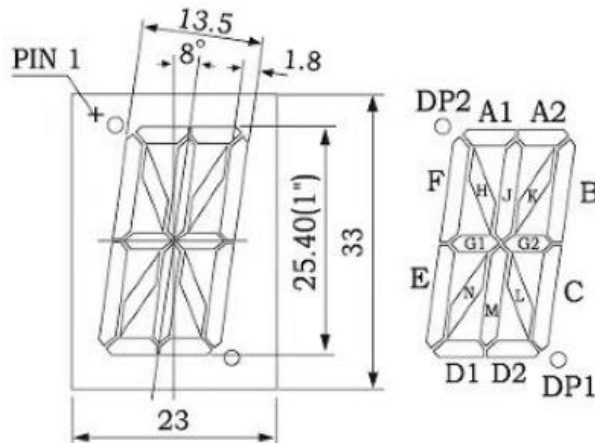

Note:

All dimensions are in millimeters (inches) tolerance are 0.25mm(0.010) unless otherwise noted

# 1.0” Inch LED DISPLAY

## ESD-SQ1X1001D24D

REV:A / 0

### ■ FEATURES:

- 1.0” Inch LED DISPLAY
- High intensity and reliability
- High quality, Low power requirement
- IC compatible , Easy assembly

### ■ DESCRIPTION:

- Black face, White fields
- Common Anode ( SQ111001 ) / Cathode(SQ121001) Display
- Red Color(AIGaInP)
- RoHS Compliant

### ■ INTERNAL CIRCUIT DIAGRAM

SQ121001\*

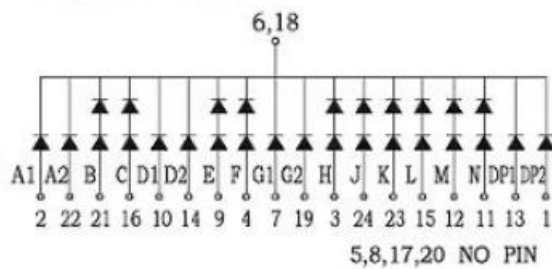

SQ111001\*

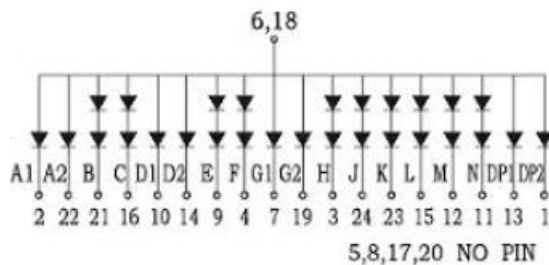

# 1.0" Inch LED DISPLAY

## ESD-SQ1X1001D24D

REV:A / 0

### ■ ABSOLUTE MAXIMUM RATINGS AT Ta=25°C:

PARAMETER	Max.	UNIT
Power Dissipation Per Segment	100	mW
Peak Forward Current Per Segment (1/10duty cycle 0.1ms pulse width)	100	mA
Average Forward Current Per Segment	30	mA
Derating Linear From 25°C Per Segment	0.33	mA/°C
Reverse Voltage Per Segment	5	V
Operating Temperature Range	-40°C to + 105°C	
Storage Temperature Range	-40°C to + 105°C	

Lead Soldering Temperature 260°C at 1.6mm From Body for 3 seconds

### ■ ELECTRICAL/OPTICAL CHARACTERISTICS AT Ta=25°C:

PARAMETER	SYMBOL	MIN.	TYP.	MAX.	UNIT	Test condition
Luminous Intensity Per Segment	$I_v$		400		mcd	$I_F=10mA$
Dominant Wavelength	$\lambda_d$	620		630	nm	$I_F=10mA$
Forward Voltage Per Dice	$V_F$	1.8		2.4	V	$I_F=10mA$
Reverse Current Per Dice	$I_R$	--	--	50	$\mu A$	$V_R=5V$

# 1.0" Inch LED DISPLAY

## ESD-SQ1X1001D24D

REV:A / 0

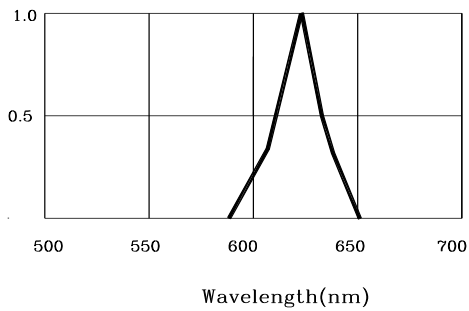
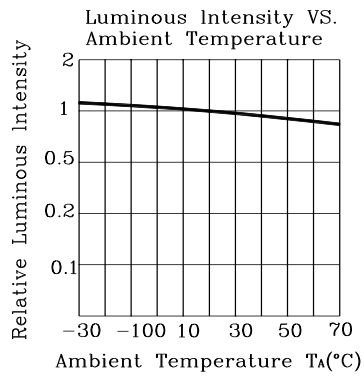
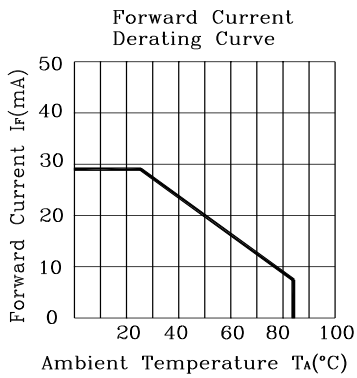
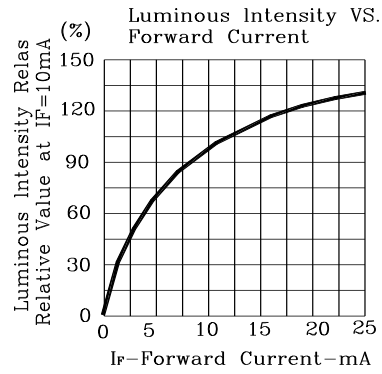
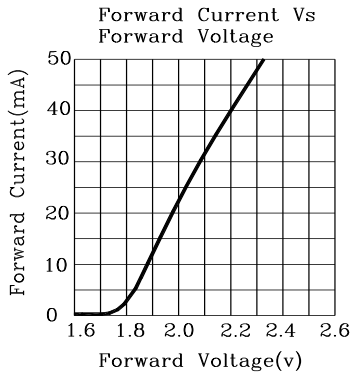

1.0” Inch LED DISPLAY

ESD-SQ1X1001D24D

REV:A / 0

■ Recommended SMT condition:

## Looking for pricing, stock, or lifecycle information?

Click below to explore more details on WIN SOURCE:

- [View ESD-SQ1X1001D24D on WIN SOURCE](#)
- [Shanghai Everstar Electronics Co., Ltd. Information](#)

## Optimize Your Supply Chain with WIN SOURCE Solutions

- ✓ Global Sourcing Solution
- ✓ Obsolete Management
- ✓ Cost Control Management
- ✓ Shortage Management
- ✓ Alternative Solution
- ✓ Excess Inventory Management