

ALUMINUM ELECTROLYTIC CAPACITORS

UWG

Chip Type, Low Impedance



- Chip type, operating over wide temperature range of to -55 to $+105^{\circ}\text{C}$.
- Designed for surface mounting on high density PC board.
- Applicable to automatic mounting machine fed with carrier tape.
- Compliant to the RoHS directive (2011/65/EU, (EU)2015/863).
- AEC-Q200 Qualified. Please contact us for details.

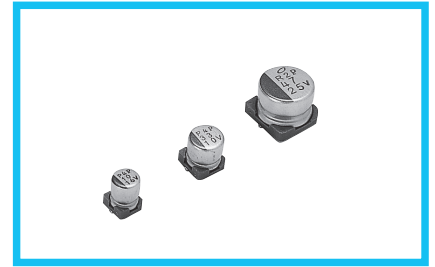

Specifications

Item	Performance Characteristics						
Category Temperature Range	-55 to $+105^{\circ}\text{C}$						
Rated Voltage Range	6.3 to 50V						
Rated Capacitance Range	1 to 1500 μF						
Capacitance Tolerance	$\pm 20\%$ at 120Hz, 20°C						
Leakage Current ※	After 2 minutes' application of rated voltage at 20°C , leakage current is not more than 0.01CV or $3(\mu\text{A})$, whichever is greater.						
Tangent of loss angle (tan δ)	Measurement frequency : 120Hz at 20°C						
	Rated voltage (V)	6.3	10	16	25	35	50
Stability at Low Temperature	Measurement frequency : 120Hz						
	Rated voltage (V)	6.3	10	16	25	35	50
Endurance	The specifications listed at right shall be met when the capacitors are restored to 20°C after the rated voltage is applied for 1000 hours at 105°C .		Capacitance change				Within $\pm 20\%$ of the initial capacitance value
			tan δ				200% or less than the initial specified value
Shelf Life	After storing the capacitors under no load at 105°C for 1000 hours and then performing voltage treatment based on JIS C 5101-4 clause 4.1 at 20°C , they shall meet the specified values for the endurance characteristics listed above.		Leakage current				Less than or equal to the initial specified value
			Capacitance change				Within $\pm 10\%$ of the initial capacitance value
Resistance to soldering heat	The capacitors are kept on a hot plate for 30 seconds, which is maintained at 250°C . The capacitors shall meet the characteristic requirements listed at right when they are removed from the plate and restored to 20°C .		tan δ				Less than or equal to the initial specified value
			Leakage current				Less than or equal to the initial specified value
Marking	Black print on the case top.						

※ I : Leakage Current (μA), C : Rated Capacitance (μF), V : Rated Voltage (V)

Chip Type

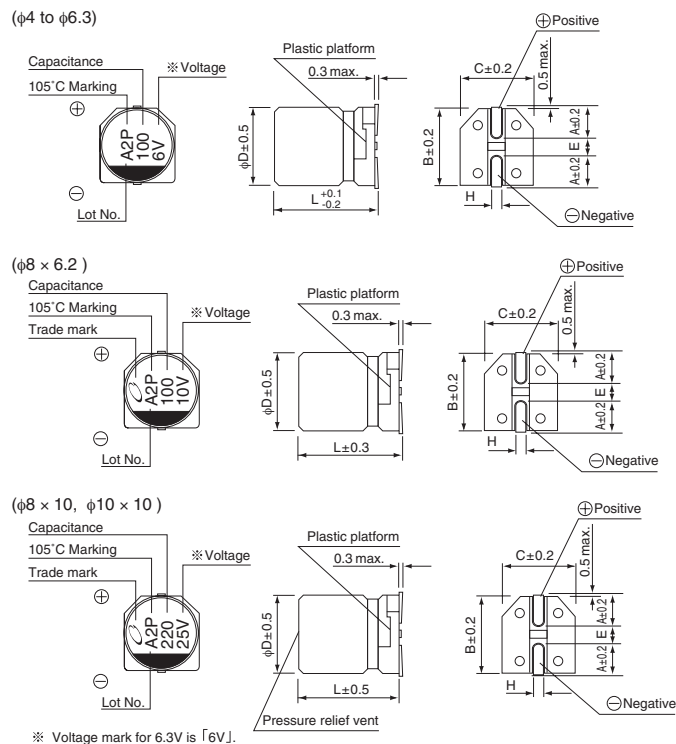

Type numbering system (Example : 10V 100 μF)

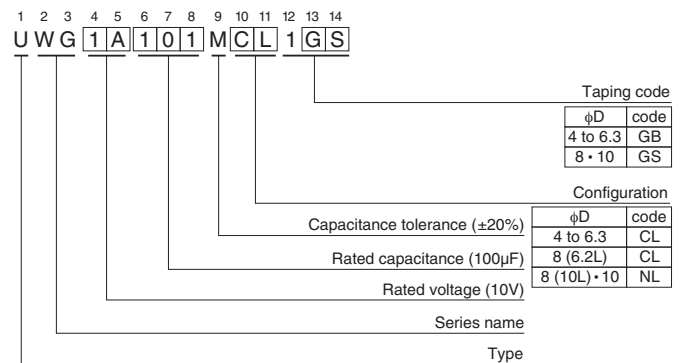

$\phi D \times L$	4 × 5.4	5 × 5.4	6.3 × 5.4	8 × 6.2	8 × 10	10 × 10
A	1.8	2.1	2.4	3.3	2.9	3.2
B	4.3	5.3	6.6	8.3	8.3	10.3
C	4.3	5.3	6.6	8.3	8.3	10.3
E	1.0	1.3	2.2	2.3	3.1	4.5
L	5.4	5.4	5.4	6.2	10	10
H	0.5 to 0.8	0.5 to 0.8	0.5 to 0.8	0.5 to 0.8	0.8 to 1.1	0.8 to 1.1

(mm)

Frequency coefficient of rated ripple current

Frequency	50 Hz	120 Hz	300 Hz	1 kHz	10 kHz or more
Coefficient	0.35	0.50	0.64	0.83	1.00

● Dimension table in next page.





■ Dimensions

Rated Voltage (V) (code)	Rated Capacitance (μF)	Case Size φD×L (mm)	tan δ	Leakage Current (μA) (at 20°C after 2 minutes)	Impedance (Ω) max. (20°C/100kHz)	Rated Ripple (mA rms) (105°C/100kHz)	Part Number
6.3 (0J)	22	4×5.4	0.26	3	3.00	60	UWG0J220MCL1GB
	47	5×5.4	0.26	3	1.80	95	UWG0J470MCL1GB
	68	6.3×5.4	0.26	4.284	1.00	140	UWG0J680MCL1GB
	100	6.3×5.4	0.26	6.3	1.00	140	UWG0J101MCL1GB
	220	8×6.2	0.26	13.86	0.40	230	UWG0J221MCL1GS
	330	8×10	0.26	20.79	0.30	450	UWG0J331MNL1GS
	1000	10×10	0.26	63	0.15	670	UWG0J102MNL1GS
	1500	10×10	0.26	94.5	0.15	670	UWG0J152MNL1GS
10 (1A)	33	5×5.4	0.19	3.3	1.80	95	UWG1A330MCL1GB
	100	8×6.2	0.19	10	0.40	230	UWG1A101MCL1GS
	150	8×6.2	0.19	15	0.40	230	UWG1A151MCL1GS
	220	8×10	0.19	22	0.30	450	UWG1A221MNL1GS
	470	10×10	0.19	47	0.15	670	UWG1A471MNL1GS
	1000	10×10	0.19	100	0.15	670	UWG1A102MNL1GS
16 (1C)	10	4×5.4	0.16	3	3.00	60	UWG1C100MCL1GB
	22	5×5.4	0.16	3.52	1.80	95	UWG1C220MCL1GB
	47	6.3×5.4	0.16	7.52	1.00	140	UWG1C470MCL1GB
	68	8×6.2	0.16	10.88	0.40	230	UWG1C680MCL1GS
	100	8×6.2	0.16	16	0.40	230	UWG1C101MCL1GS
	220	10×10	0.16	35.2	0.15	670	UWG1C221MNL1GS
	330	10×10	0.16	52.8	0.15	670	UWG1C331MNL1GS
	470	10×10	0.16	75.2	0.15	670	UWG1C471MNL1GS
	680	10×10	0.16	108.8	0.15	670	UWG1C681MNL1GS
25 (1E)	6.8	4×5.4	0.14	3	3.00	60	UWG1E68MCL1GB
	22	6.3×5.4	0.14	5.5	1.00	140	UWG1E220MCL1GB
	33	6.3×5.4	0.14	8.25	1.00	140	UWG1E330MCL1GB
	47	8×6.2	0.14	11.75	0.40	230	UWG1E470MCL1GS
	68	8×10	0.14	17	0.30	450	UWG1E680MNL1GS
	100	8×10	0.14	25	0.30	450	UWG1E101MNL1GS
	220	10×10	0.14	55	0.15	670	UWG1E221MNL1GS
	330	10×10	0.14	82.5	0.15	670	UWG1E331MNL1GS
	470	10×10	0.14	117.5	0.15	670	UWG1E471MNL1GS
35 (1V)	1	4×5.4	0.12	3	3.00	60	UWG1V010MCL1GB
	2.2	4×5.4	0.12	3	3.00	60	UWG1V2R2MCL1GB
	3.3	4×5.4	0.12	3	3.00	60	UWG1V3R3MCL1GB
	4.7	4×5.4	0.12	3	3.00	60	UWG1V4R7MCL1GB
	6.8	5×5.4	0.12	3	1.80	95	UWG1V6R8MCL1GB
	10	5×5.4	0.12	3.5	1.80	95	UWG1V100MCL1GB
	22	6.3×5.4	0.12	7.7	1.00	140	UWG1V220MCL1GB
	33	8×6.2	0.12	11.55	0.40	230	UWG1V330MCL1GS
	47	8×6.2	0.12	16.45	0.40	230	UWG1V470MCL1GS
	100	10×10	0.12	35	0.15	670	UWG1V101MNL1GS
	220	10×10	0.12	77	0.15	670	UWG1V221MNL1GS
	330	10×10	0.12	115.5	0.15	670	UWG1V331MNL1GS
50 (1H)	1	4×5.4	0.12	3	5.00	30	UWG1H010MCL1GB
	2.2	4×5.4	0.12	3	5.00	30	UWG1H2R2MCL1GB
	3.3	4×5.4	0.12	3	5.00	30	UWG1H3R3MCL1GB
	4.7	5×5.4	0.12	3	3.00	50	UWG1H4R7MCL1GB
	10	6.3×5.4	0.12	5	2.00	70	UWG1H100MCL1GB
	22	8×6.2	0.12	11	0.70	120	UWG1H220MCL1GS
	33	8×10	0.12	16.5	0.60	300	UWG1H330MNL1GS
	47	10×10	0.12	23.5	0.30	500	UWG1H470MNL1GS
	100	10×10	0.12	50	0.30	500	UWG1H101MNL1GS
	220	10×10	0.12	110	0.30	500	UWG1H221MNL1GS







- For taping specifications, recommended land size/soldering by reflow and minimum order quantity, please refer to the Guidelines for Aluminum Electrolytic Capacitors.
- Please select UUJ if high C/V products are required.

Looking for pricing, stock, or lifecycle information?

Click below to explore more details on WIN SOURCE:

-  [View UWG1C681MNL1GS on WIN SOURCE](#)
-  [Nichicon Information](#)

Optimize Your Supply Chain with WIN SOURCE Solutions

-  Global Sourcing Solution
-  Obsolete Management
-  Cost Control Management
-  Shortage Management
-  Alternative Solution
-  Excess Inventory Management