

MEGA® High Performance Series

Bolt-down Fuses – Rated 70V-SF51



Description

MEGA® 70V High Performance SF51 automotive fuses employ diffusion pill technology to provide predictable time-delayed circuit protection. These MEGA fuses are ideal for protecting batteries, alternators, and heavy gauge wire harnesses that experience large inrushes of current. Use fuses with ampere ratings between 350 A and 500 A only for short circuit protection.

Features & Benefits

- Available with ampere ratings of 60 A to 500 A
- Available with two, one, or no mounting holes
- 51 mm pitch prevents mistaken replacement with other types of high-current fuses
- High-contrast, color-coded ampere rating stamps on housings aid identification
- Refer to ISO 20934 - Type SF51

Applications

- Cars / SUVs
- Buses
- Trucks
- Watercraft as approved by Littelfuse®
- Offroad vehicles

[See Disclaimer Notice](#)

Specifications

Voltage Rating:	70 V DC
Interrupting Rating:	2500 A @ 70 V DC
Recommended Environmental Temperature:	-40 °C to +125 °C
Terminals Material:	Tin-plated copper alloy
Housing Material:	PPA-GF33 (U.L. 94 Flammability rating - HB)
Mounting Torque M6:	9 Nm ± 1 Nm
Mounting Torque M8:	12 Nm ± 1 Nm
Refer to:	ISO 20934 - Type SF51
Open State Resistance (after fuse opening):	>1MΩ

Agency Approvals

Agency	Agency File Number	Current Rating (A)
	UL-US-2210474-0	60 – 500

Additional Information



Resources



Samples















Ordering Information

Part Number	Current Rating (A)	Bolt Size	Bolt Hole Qty.	Package Size
0998xxx.UX-2M8	60 - 500	M8	2	500
0998xxx.UX-1M8	60 - 500	M8	1	500
0998xxx.UX-2M6	60 - 500	M6	2	500
0998xxx.UX-1M6	60 - 500	M6	1	500
0998xxx.UX-NH	60 - 500	-	-	500

MEGA® High Performance Series

Bolt-down Fuses – Rated 70V-SF51

Ratings

Part Number	Current Rating (A)	Font Color	Test Cable Size (mm ²)	Typ. Voltage Drop (mV)	Typ. Cold Resistance (mΩ)	Typ. I ² t (A ² s)
0998060_	60		6	75.5	0.90	22 800
0998080_	80		10	88.0	0.75	34 900
0998100_	100		10	66.7	0.46	24 000
0998125_	125		16	70.4	0.37	38 000
0998150_	150		25	70.6	0.32	58 100
0998175_	175		25	79.2	0.28	79 300
0998200_	200		35	76.9	0.24	123 600
0998225_	225		35	76.6	0.21	142 500
0998250_	250		50	66.0	0.17	220 000
0998300_	300		50	46.9 ²	0.15	340 000
0998350_	350 ¹		50	50.7 ²	0.14	495 000
0998400_	400 ¹		70	50.1 ²	0.12	872 000
0998450_	450 ¹		70	52.9 ²	0.10	1 224 000
0998500_	500 ¹		70	56.3 ²	0.09	1 800 000

¹ Short Circuit Protector only

² Voltage Drop measurements for short circuit protectors taken at 75% of rated current.

Note: The typical I²t is an average value calculated from the breaking capacity tests by using the melting time before the arcing occurs.

Dimensions

Dimensions in mm. Please refer to the outline drawing for dimensions and tolerances.

MEGA HP SF51 2 Holes M8/M6 versions

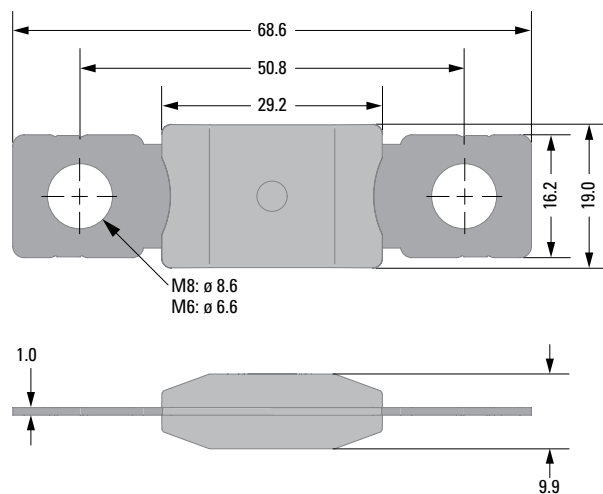

MEGA HP SF51 1 Hole M8/M6 versions

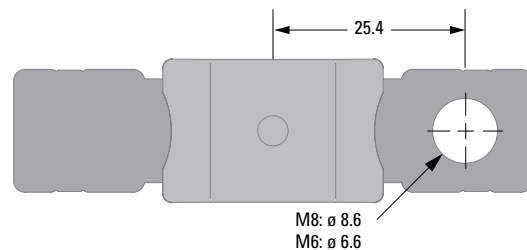

MEGA HP SF51 No-Holes version

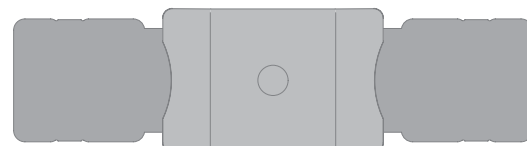

MEGA® High Performance Series

Bolt-down Fuses – Rated 70V-SF51

Time-Current Characteristic

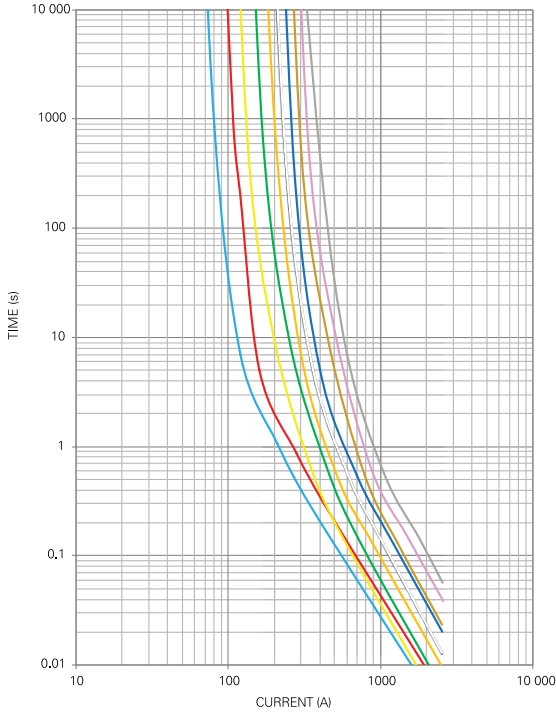

% of Rating	Opening Time Min. / Max. (s)	
	60 - 250 A	300 A
75	- / -	14 400 / -
100	14 400 / -	- / -
135	120 / 1800	120 / 1800
150	20 / 450	20 / 450
200	1 / 15	1 / 15
350	0.3 / 5	0.3 / 5
600	0.1 / 1	0.1 / 1

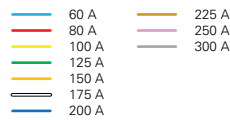

Note: Current recommendation may be impacted by the final condition of the application (terminals characteristics, wire size etc.). Please contact Littelfuse® for more information.

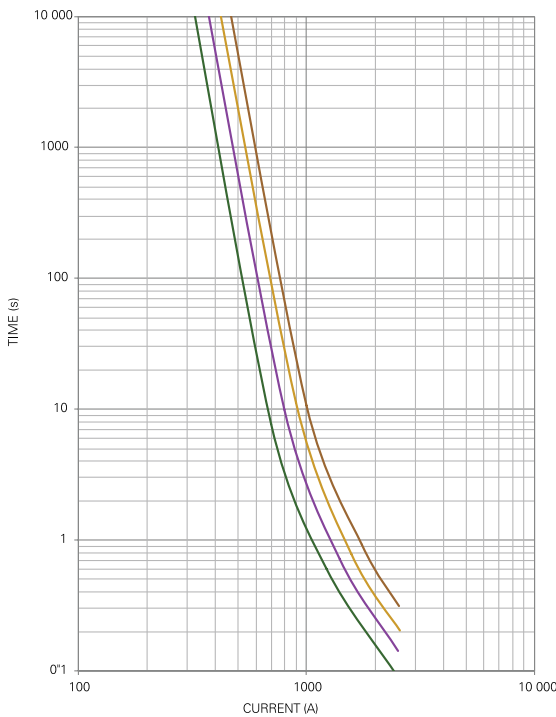

% of Rating	Opening Time Min. / Max. (s)
	350 - 500 A
75	14 400 / -
100	- / -
135	- / -
150	- / -
200	1 / 15
350	0.5 / 5
600	0.1 / 1

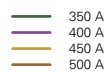

Note: Current recommendation may be impacted by the final condition of the application (terminals characteristics, wire size etc.). Please contact Littelfuse® for more information.

Disclaimer Notice - Information furnished is believed to be accurate and reliable. However, users should independently evaluate the suitability of and test each product selected for their own applications. Littelfuse products are not designed for, and may not be used in, all applications. Read complete Disclaimer Notice at <https://www.littelfuse.com/legal/disclaimers/product-disclaimer.aspx>

MEGA® High Performance Series

Bolt-down Fuses – Rated 70V-SF51

Typical Derating Curves

Temperature security margin is 20%.

Please contact Littelfuse® for Details Regarding Derating Test Set Up.

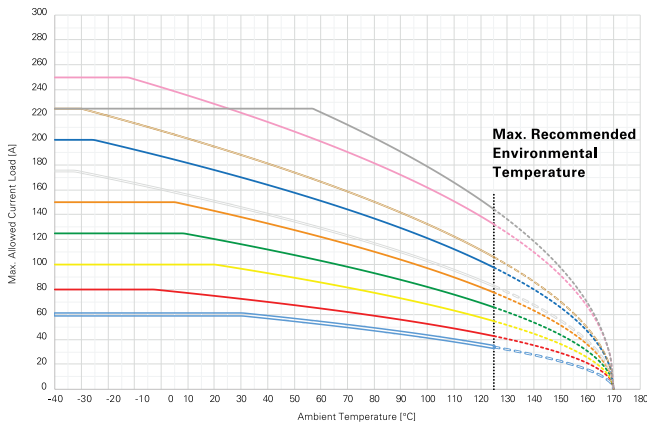

	Max. allowed current load (A) at ambient temperature based on typical derating						
	-40 °C	0 °C	20 °C	65 °C	85 °C	110 °C	125 °C
60A	60	60	60	52	47	39	34
80A	80	79	75	63	57	49	43
100A	100	100	100	84	75	63	55
125A	125	125	120	101	90	76	66
150A	150	150	143	119	107	90	78
175A	175	160	151	126	114	95	83
200A	200	187	176	148	133	112	98
225A	225	207	195	163	146	123	106
250A	250	242	229	194	177	151	132
300A	225	225	225	217	196	166	144
350A	263	263	263	222	200	168	146
400A	300	300	296	250	226	191	167
450A	338	330	311	262	237	201	175
500A	375	344	323	272	246	207	180

- 60 A
- 80 A
- 100 A
- 125 A
- 150 A
- 175 A
- 200 A
- 225 A
- 250 A
- 300 A

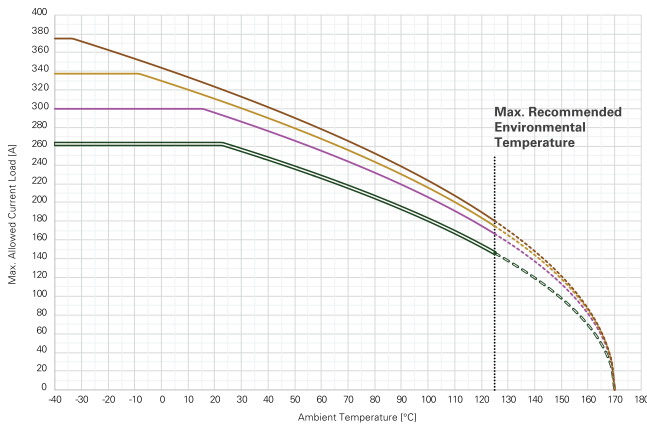

- 350 A
- 400 A
- 450 A
- 500 A

Note: Current recommendation may be impacted by the final condition of the application (terminals characteristics, wire size etc.). Please contact Littelfuse® for more information.

Disclaimer Notice - Information furnished is believed to be accurate and reliable. However, users should independently evaluate the suitability of and test each product selected for their own applications. Littelfuse products are not designed for, and may not be used in, all applications. Read complete Disclaimer Notice at <https://www.littelfuse.com/legal/disclaimers/product-disclaimer.aspx>

Looking for pricing, stock, or lifecycle information?

Click below to explore more details on WIN SOURCE:

 [View 0998500.UX-2M8 on WIN SOURCE](#)

 [Littelfuse Inc. Information](#)

Optimize Your Supply Chain with WIN SOURCE Solutions

-  Global Sourcing Solution
-  Obsolete Management
-  Cost Control Management
-  Shortage Management
-  Alternative Solution
-  Excess Inventory Management