



**THE DATASHEET OF  
C1F 3**



# Type C1F

## Surface Mount Fast Acting Chip Fuse

HF  C1F Series – 1206 Size



RoHS Compliant

### Features

- Fast Acting, with improved surge withstand performance
- Small size, 1206 SMD
- Current rating from 250mA to 8A, fuse marked with ampere code
- Wide operating temperature range from -55°C to 125°C
- Tape and Reel for automatic SMD placement
- Compatible with 260°C IR Pb-free and wave soldering process
- Full compliance with EU Directive 2011/65/EU and amending directive 2015/863 (MSL = 1)
- Halogen Free and Lead Free
- AEC-Q Compliant
- Meets Bel automotive qualification\*
- \* - Largely based on internal AEC-Q test plan

### Applications

- Automotive Navigation System
- Thin film transistor LCD flat-panel display screen
- Notebook
- PC computer
- Office electronic equipment
- Industrial equipment
- Medical equipment
- POE, POE+
- LCD / LED monitor
- Power supply
- LCD / LED TV
- DC-DC Converter

LEAD FREE =   
 HALOGEN FREE = 

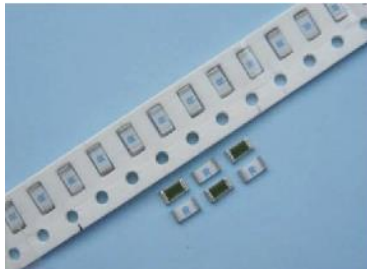

UK  
CA c  CE  
**AEC-Q Compliant**

### Typical Part Marking

Fuse body (ceramic white side) marked with marking code.

Example:



Current Rating	Marking Code	Current Rating	Marking Code
250mA	E	2.5A	T
375mA	H	3A	3
500mA	J	3.5A	Z
750mA	M	4A	4
1A	1	5A	5
1.25A	P	6A	6
1.5A	R	7A	7
2A	2	8A	8

### Electrical Characteristics (UL STD. 248-14)



Testing Current	Blow Time	
	Minimum	Maximum
100%	4 Hrs.	N/A
200%	N/A	5 Sec
300%	N/A	0.2 Sec

### Safety Agency Approvals

Safety Agency	Safety Agency Certificate	Ampere Rating/ Voltage Rating	Ampere Range / Volt @ I.R. ability*
	E20624	250mA–8A/125V AC /63V DC	250mA–6A/100A@ 125V AC
			7A–8A/35A@ 125V AC /50A@ 63V DC

\*I.R.= Interrupting Rating = Short Circuit Rating(Amps)

### Physical Specifications

Materials	Body : Ceramic Substrate
	Terminations : Ag / Ni / Sn (100% Lead-free)
	Element Cover Coating : Lead-free Glass
Marking	On Fuse :
	Marking Code
	On Label :
	"bel", "C1F", "Current Rating", "Voltage Rating", "Interrupting Rating", "Appropriate Safety Logos" and "  ", "  " (China RoHS compliant).

Specifications subject to change without notice

## Temperature Derating Curve

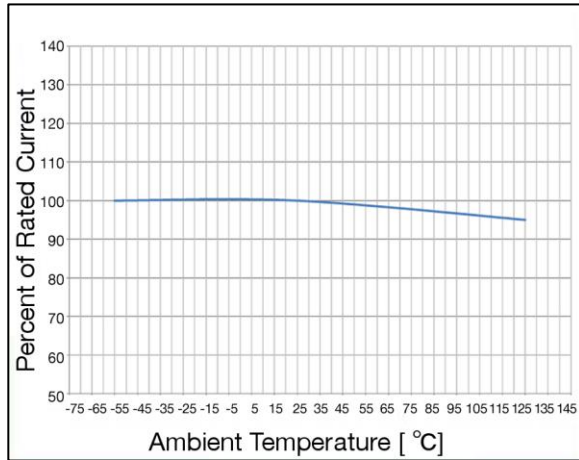

## Average Time Current Curve

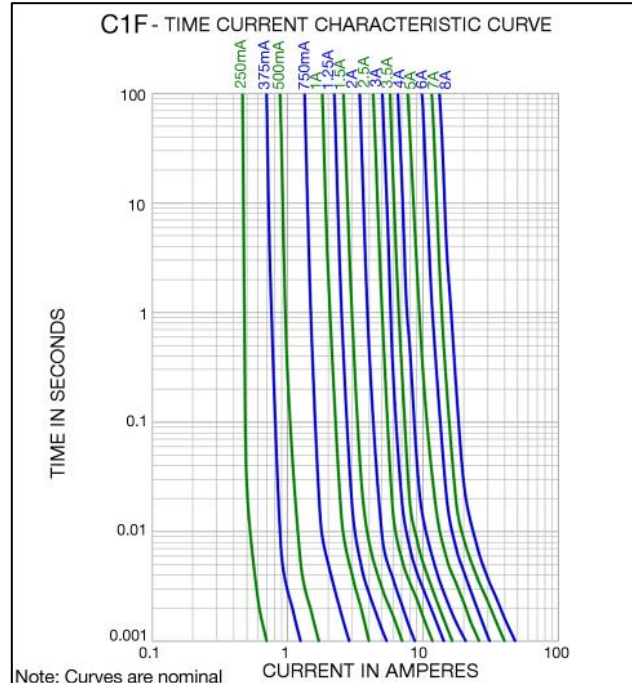

## Electrical Specifications

Part Number	Ampere Rating (A)	Marking Code	Nominal Cold Resistance (ohms)	Maximum Volt-drop @ 100% In (Volt) max.	Voltage and Interrupting Ratings	Nominal Melting I <sup>2</sup> T @ 10 In (A <sup>2</sup> Sec)	Maximum Power Dissipation @ 100% In (W)	Agency Approvals
0685F0250-XX	250mA	E	2.30	0.813	See Table of Safety Approvals on Page 1 for Voltage and associated Interrupting Ratings	0.0002	0.20	Y
0685F0375-XX	375mA	H	1.25	0.789		Y		
0685F0500-XX	500mA	J	0.87	0.693		Y		
0685F0750-XX	750mA	M	0.43	0.476		Y		
0685F1000-XX	1A	1	0.28	0.421		Y		
0685F1250-XX	1.25A	P	0.210	0.411		Y		
0685F1500-XX	1.5A	R	0.165	0.400		Y		
0685F2000-XX	2A	2	0.068	0.194		Y		
0685F2500-XX	2.5A	T	0.049	0.198		Y		
0685F3000-XX	3A	3	0.039	0.166		Y		
0685F3500-XX	3.5A	Z	0.032	0.164		Y		
0685F4000-XX	4A	4	0.026	0.164		Y		
0685F5000-XX	5A	5	0.020	0.164		Y		
0685F6000-XX	6A	6	0.015	0.163		Y		
0685F7000-XX	7A	7	0.012	0.154		Y		
0685F8000-XX	8A	8	0.010	0.148		Y		

Consult manufacturer for other ratings

### NOTES: Test Conditions

All test for ratings 250mA - 5A were conducted with fuse samples soldered on a PCB (1.6mm thick) test board with copper traces measuring 0.035 mm (35µm) nominal thickness (1 oz. clad), 5mm wide and 100mm overall length.

All test for ratings 6A-8A were conducted with fuse samples soldered on a PCB (1.6mm thick) test board with copper traces measuring 0.070 mm (70µm) nominal thickness (2 oz. clad), 7.5mm wide and 100mm overall length.

Device designed to be mounted with marking facing up.

Device designed to carry rated current for 4 hours minimum. It is recommended that device be operated continuously at no more than 80% of rated current when in a +25°C ambient, with further derating at elevated ambient temperatures.



Specifications subject to change without notice

Bel Fuse Inc.  
206 Van Vorst Street  
Jersey City, NJ 07302 USA

+1 201.432.0463  
Bel.US.CS@belf.com  
[belfuse.com/circuit-protection](http://belfuse.com/circuit-protection)

## Environmental Specifications

Shock Resistance	MIL-STD-202G, Method 213B, Test Condition 1 (100 G's peak for 6 milliseconds; Sawtooth waveform)
Vibration Resistance	MIL-STD-202G, Method 201A (10-55 Hz, 0.06 inch, total excursion).
Salt Spray Resistance	MIL-STD-202G, Method 101E, Test Condition B (48 hrs.).
Insulation Resistance	MIL-STD-202G, Method 302, Test Condition A (After Opening) 10,000 ohms minimum.
Solderability	MIL-STD-202G, Method 208H
Resistance to solder Heat	MIL-STD-202G, Method 210F, Test Condition C. Top Side(260°C, 20 sec) MIL-STD-202G, Method 210F, Test Condition D. Bottom Side(260°C, 10 sec)
Thermal Shock	MIL-STD-202G, Method 107G, Test Condition B (-65°C to +125°C).
Operating Temperature	-55°C to +125°C
Moisture Sensitivity Level	1 (According to IPC J-Std-020)

High temperature storage	MIL-STD-202 Method 108
Temperature cycling	JESD22 Method JA-104, Test Condition B
Biased humidity	MIL-STD-202 Method 103, 85C/85% RH with 10% operating power for 1000 hrs.
Operational life	MIL-STD-202 Method 108, Test Condition D
Resistance to solvents	MIL-STD-202 Method 215
Mechanical shock	MIL-STD-202 Method 213, Test Condition C
Vibration	MIL-STD-202 Method 204
Resistance to soldering heat	MIL-STD-202 Method 210, Test condition B
Thermal shock	MIL-STD-202 Method 107
Solderability	J-STD-002
Board flex(SMD)	AEC-Q200-005
Terminal strength	AEC-Q200-006
Electrical characterization	3 temperature electrical

## Soldering Parameters

IR Reflow Profile (IPC/JEDEC J-STD-020D)	
<b>Preheat &amp; Soak</b>	
Temperature min ( $T_{smin}$ )	150°C
Temperature max ( $T_{smax}$ )	200°C
Time ( $T_{smin}$ to $T_{smax}$ ) ( $t_s$ )	60-120 seconds
Average ramp-up rate ( $T_{smax}$ to $T_p$ )	3°C/second max.
Liquidous temperature ( $T_L$ )	217°C
Time at liquidous ( $t_L$ )	60-150 seconds
Peak temperature ( $T_p$ )	260°C max
Time ( $t_p$ ) within 5°C of the specified classification temperature ( $T_c$ )	30 seconds
Average ramp-down rate ( $T_p$ to $T_{smax}$ )	6°C/second max.
Time 25°C to peak temperature	8 minutes max.

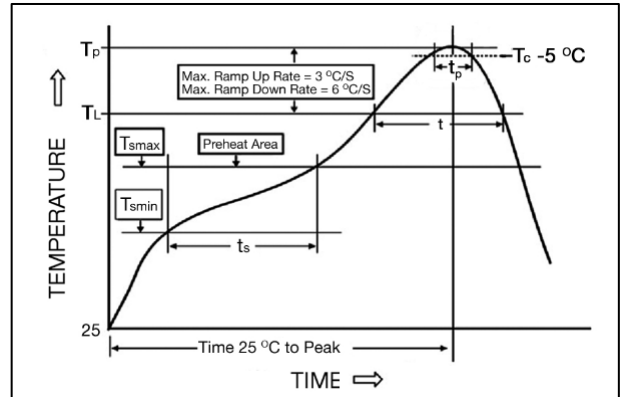

Lead-free Wave Soldering Profile	
Wave Soldering Parameter	
Average ramp-up rate	200°C / second
Heating rate during preheat	typical 1 - 2°C / second Max 4°C / second
Final preheat temperature	within 125°C of soldering temperature
Peak temperature $T_p$	260°C
Time within +0°C / -5°C of actual peak temperature	10 seconds
Ramp-down rate	5°C / second max.

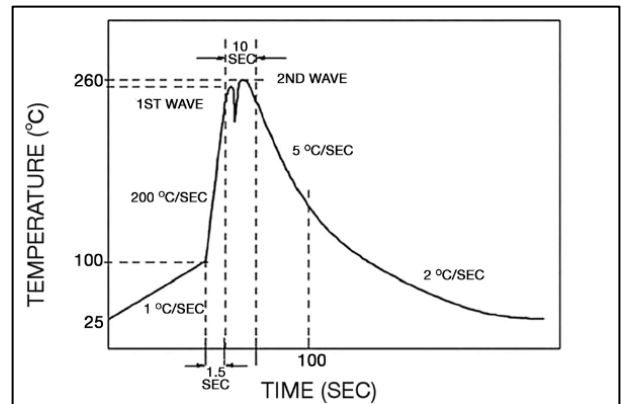

Specifications subject to change without notice

Bel Fuse Inc.  
206 Van Vorst Street  
Jersey City, NJ 07302 USA

+1 201.432.0463  
Bel.US.CS@belf.com  
[belfuse.com/circuit-protection](http://belfuse.com/circuit-protection)

## Fuse FGNO Explanation

0685 F [XXXX] -XX

0685F=C1F; [XXXX]=Ampere Rating; XX=See Ordering Information as below

Fraction	Decimal	Milliamps	Bel FGNO[XXXX]
1/4	0.250	250	0250
3/8	.375	375	0375
1/2	.500	500	0500
3/4	.750	750	0750

Fraction	Decimal	Amps	Bel FGNO[XXXX]
	1.0	1	1000
1-1/4	1.25	1.25	1250
1-1/2	1.50	1.5	1500
	2.0	2	2000
2-1/2	2.5	2.5	2500
	3.0	3	3000
3-1/2	3.5	3.5	3500
	4.0	4	4000
	5.0	5	5000
	6.0	6	6000
	7.0	7	7000
	8.0	8	8000

## Mechanical Dimensions

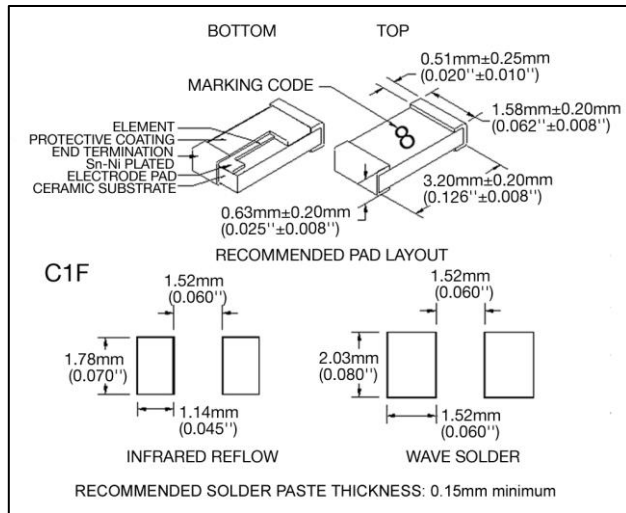

## Ordering Information

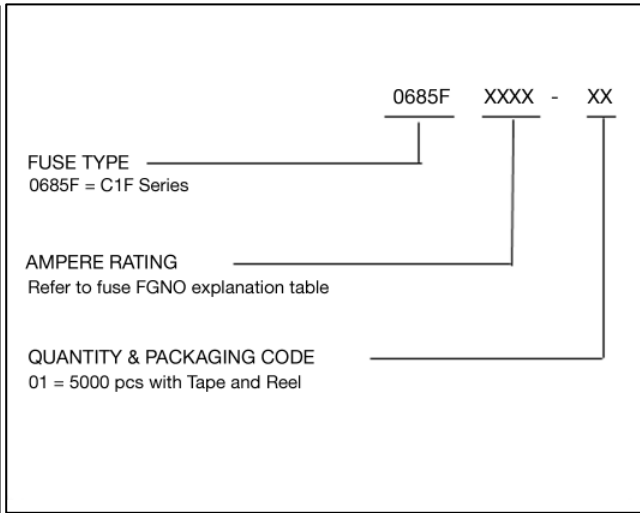

## Packaging

Packaging Tape & Reel	Packaging Specification	Quantity	Quantity & Packaging Code
8 mm wide tape with 7 inches Diameter reel	EIA Standard 481-E	5000	0685FXXXX-01





Specifications subject to change without notice

Bel Fuse Inc.  
206 Van Vorst Street  
Jersey City, NJ 07302 USA

+1 201.432.0463  
Bel.US.CS@belf.com  
[belfuse.com/circuit-protection](http://belfuse.com/circuit-protection)

## Looking for pricing, stock, or lifecycle information?

Click below to explore more details on WIN SOURCE:

-  [View C1F 3 on WIN SOURCE](#)
-  [Bel Fuse Inc. Information](#)

## Optimize Your Supply Chain with WIN SOURCE Solutions

-  Global Sourcing Solution
-  Obsolete Management
-  Cost Control Management
-  Shortage Management
-  Alternative Solution
-  Excess Inventory Management