

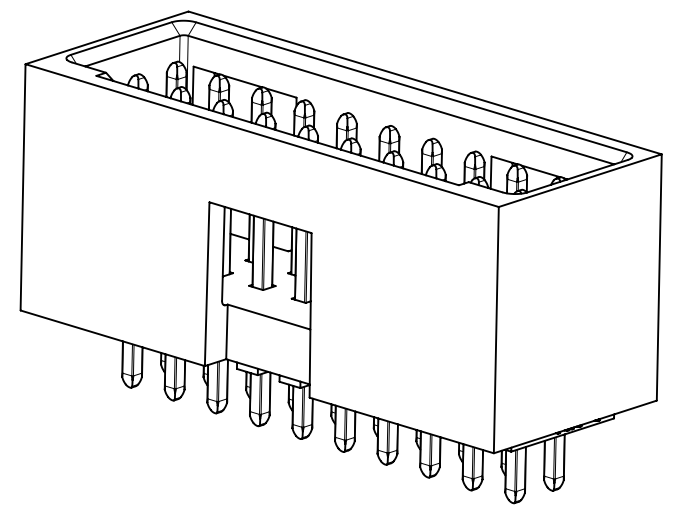

**THE DATASHEET OF**  
**0015800301**

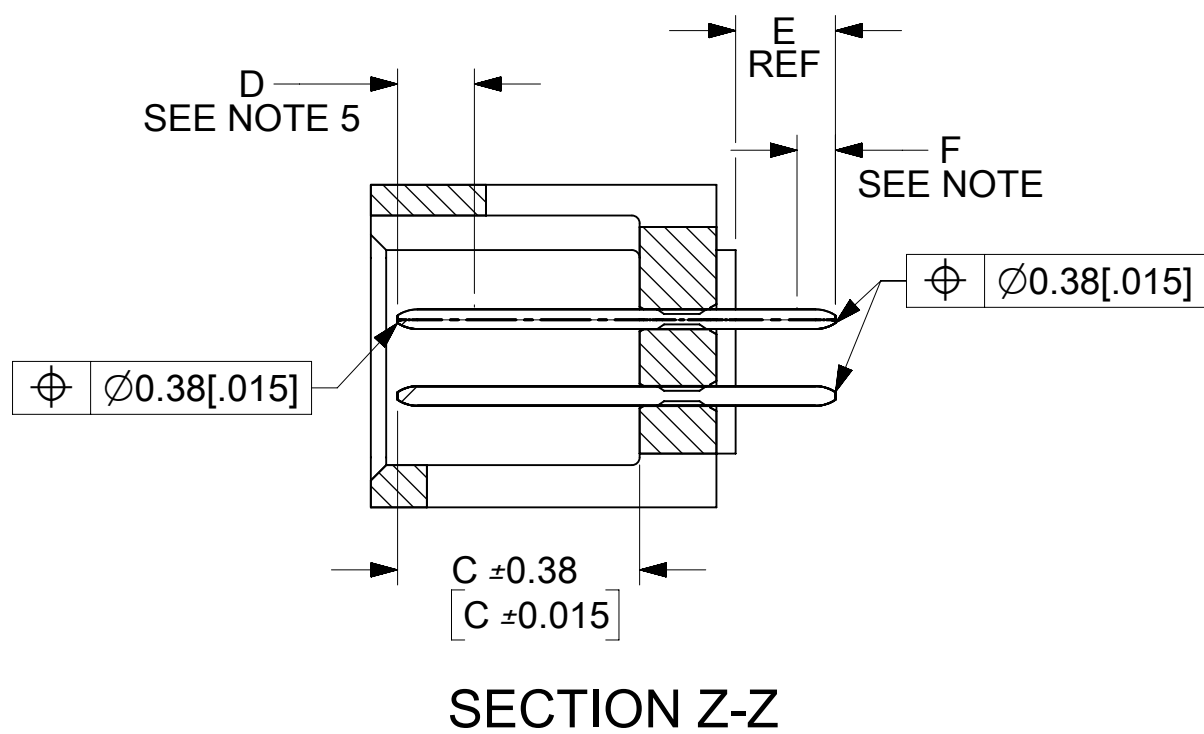

# OPTION A

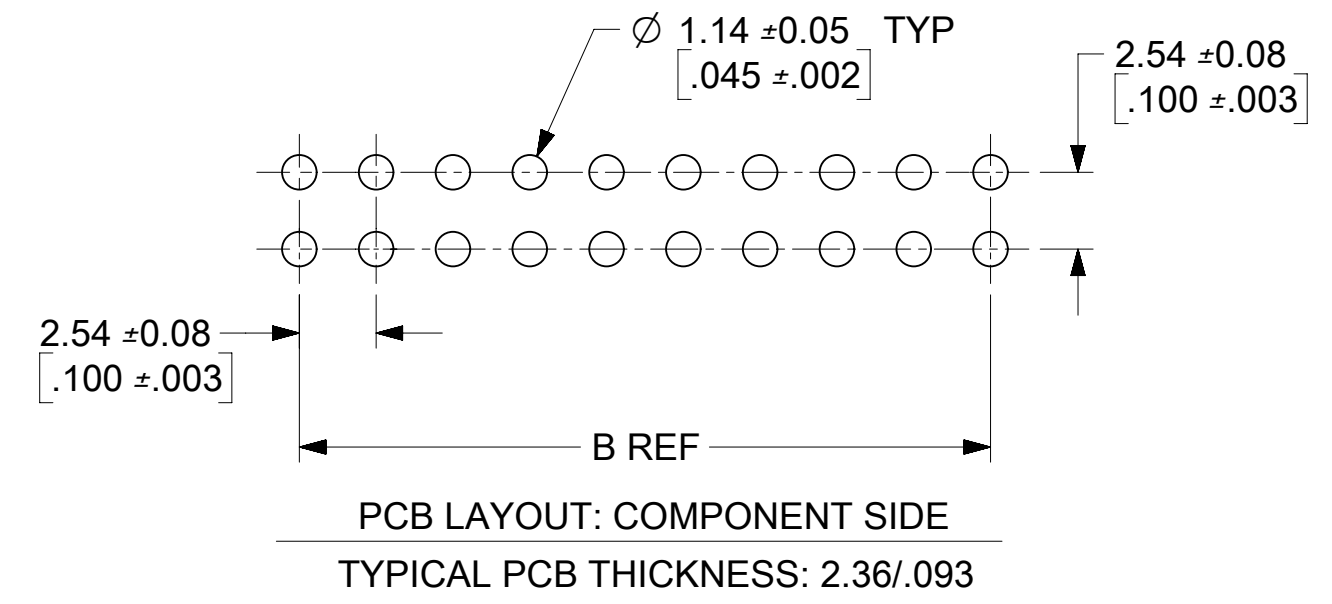
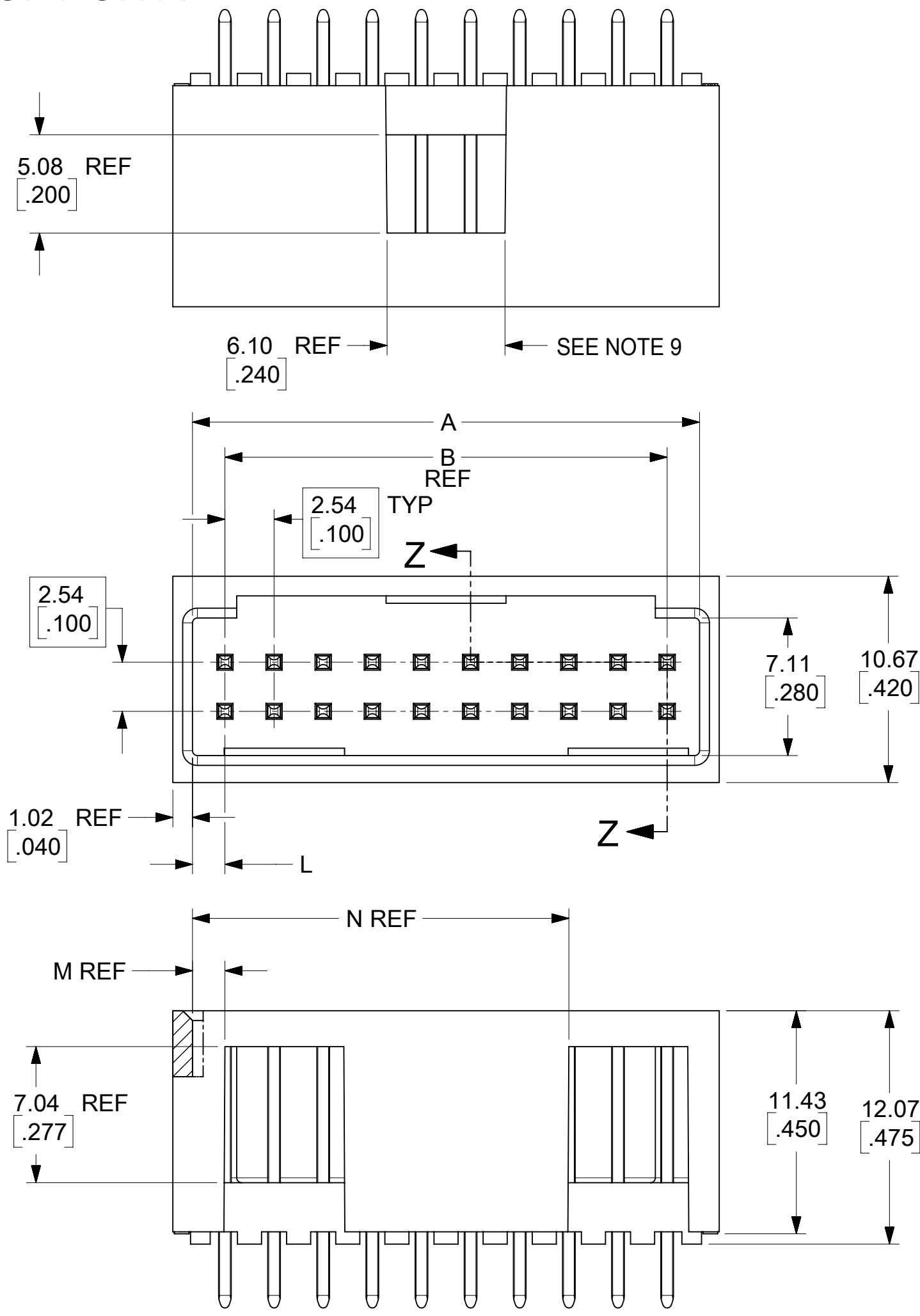

- NOTES:**
- MATERIAL: GLASS FILLED, LIQUID CRYSTAL POLYMER, COLOR: BLACK, 94V-0. PINS: COPPER ALLOY.
  - PLATING:
    - TIN 150 MI MINIMUM TIN, OVER NICKEL UNDERPLATE OVERALL
    - 15 GOLD 15 MI MINIMUM GOLD PLATE IN SELECTED AREA
    - 75 MI MINIMUM TIN IN SELECTED AREA
    - OVER NICKEL UNDERPLATE OVERALL
    - 30 GOLD 30 MI MINIMUM GOLD PLATE IN SELECTED AREA
    - 75 MI MINIMUM TIN IN SELECTED AREA,
    - OVER NICKEL UNDERPLATE OVERALL
  - PRODUCT SPECIFICATION: PS-70567.
  - PACKAGING: SEE CHARTS
  - MEASURE POINT FOR PLATING THICKNESS.
  - PIN PUSHOUT FORCE: 4 LBS. MINIMUM IN DIRECTION INDICATED.
  - FOR ILLUSTRATION PURPOSES, 20 (DUAL 10) CIRCUIT SIZE HEADER SHOWN.
  - PIN SOLDERABILITY PER MOLEX SPEC. SMES-152.
  - WINDOW NOT AVAILABLE ON 6 OR 8 CIRCUIT SIZE.
  - COSMETIC SPECIFICATION PS-45499-002 CLASS B

CKT	DIM A	DIM B	DIM L	DIM M	DIM N
06	8.43 .332	5.08 .200	1.68 .066	1.68 .066	
08	10.97 .432	7.62 .300	1.68 .066	1.68 .066	
10	13.51 .532	10.16 .400	1.68 .066	4.22 .166	
12	16.05 .632	12.70 .500	1.68 .066	4.22 .166	
14	18.59 .732	15.24 .600	1.68 .066	6.76 .266	
16	21.13 .832	17.78 .700	1.68 .066	6.76 .266	
18	23.67 .932	20.32 .800	1.68 .066	9.30 .366	
20	26.21 1.032	22.86 .900	1.68 .066	1.68 .066	19.46 .766
22	28.75 1.132	25.40 1.000	1.68 .066	1.68 .066	22.00 .866
24	31.29 1.232	27.94 1.100	1.68 .066	1.68 .066	24.54 .966
26	33.83 1.332	30.48 1.200	1.68 .066	1.68 .066	27.08 1.066
28	36.37 1.432	33.02 1.300	1.68 .066	1.68 .066	29.62 1.166
30	38.91 1.532	35.56 1.400	1.68 .066	1.68 .066	32.16 1.266
32	41.45 1.632	38.10 1.500	1.68 .066	1.68 .066	34.70 1.366
34	43.99 1.732	40.64 1.600	1.68 .066	1.68 .066	37.24 1.466
36	46.53 1.832	43.18 1.700	1.68 .066	1.68 .066	39.78 1.566
38	49.07 1.932	45.72 1.800	1.68 .066	1.68 .066	42.32 1.666
40	51.61 2.032	48.26 1.900	1.68 .066	1.68 .066	44.86 1.766
42	54.15 2.132	50.80 2.000	1.68 .066	1.68 .066	47.40 1.866
44	56.69 2.232	53.34 2.100	1.68 .066	1.68 .066	49.94 1.966
46	59.23 2.332	55.88 2.200	1.68 .066	1.68 .066	52.48 2.066
48	61.77 2.432	58.42 2.300	1.68 .066	1.68 .066	55.02 2.166
50	64.31 2.532	60.96 2.400	1.68 .066	1.68 .066	57.56 2.266
52	66.85 2.632	63.50 2.500	1.68 .066	1.68 .066	60.10 2.366
54	69.39 2.732	66.04 2.600	1.68 .066	1.68 .066	62.64 2.466
56	71.93 2.832	68.58 2.700	1.68 .066	1.68 .066	65.18 2.566
58	74.47 2.932	71.12 2.800	1.68 .066	1.68 .066	67.72 2.666
60	77.01 3.032	73.66 2.900	1.68 .066	1.68 .066	70.26 2.766
62	79.55 3.132	76.20 3.000	1.68 .066	1.68 .066	72.80 2.866
64	82.09 3.232	78.74 3.100	1.68 .066	1.68 .066	75.34 2.966
66	84.63 3.332	81.28 3.200	1.68 .066	1.68 .066	77.88 3.066
68	87.17 3.432	83.82 3.300	1.68 .066	1.68 .066	80.42 3.166
70	89.71 3.532	86.36 3.400	1.68 .066	1.68 .066	82.96 3.266
72	92.25 3.632	88.90 3.500	1.68 .066	1.68 .066	85.50 3.366

<b>SYMBOLS</b> THIS DRAWING CONTAINS INFORMATION THAT IS PROPRIETARY TO MOLEX ELECTRONIC TECHNOLOGIES, LLC AND SHOULD NOT BE USED WITHOUT WRITTEN PERMISSION DIMENSION UNITS: <b>MM</b> SCALE: <b>1:1</b> GENERAL TOLERANCES (UNLESS SPECIFIED): 4 PLACES ± 3 PLACES ± 0.005 2 PLACES ± 0.13 ± 0.01 1 PLACE ± 0.25 ± 0 PLACES ± ANGULAR TOL ± 0.5° DRAFT WHERE APPLICABLE MUST REMAIN WITHIN DIMENSIONS	CURRENT REV DESC:		
	EC NO: 637057 DRWN: ABABUPS 2020/05/05 CHK'D: MRAMAKRISHNA 2020/05/06 APPR: MRAMAKRISHNA 2020/05/06	INITIAL REVISION: DRWN: APPR:	
PRODUCT CUSTOMER DRAWING DOCUMENT NUMBER: <b>SDA-70567-XXXX</b>   DOC TYPE: PSD   DOC PART: 001   REVISION: <b>K5</b>			MATERIAL NUMBER: GENERAL MARKET   CUSTOMER:   SHEET NUMBER: 1 OF 8

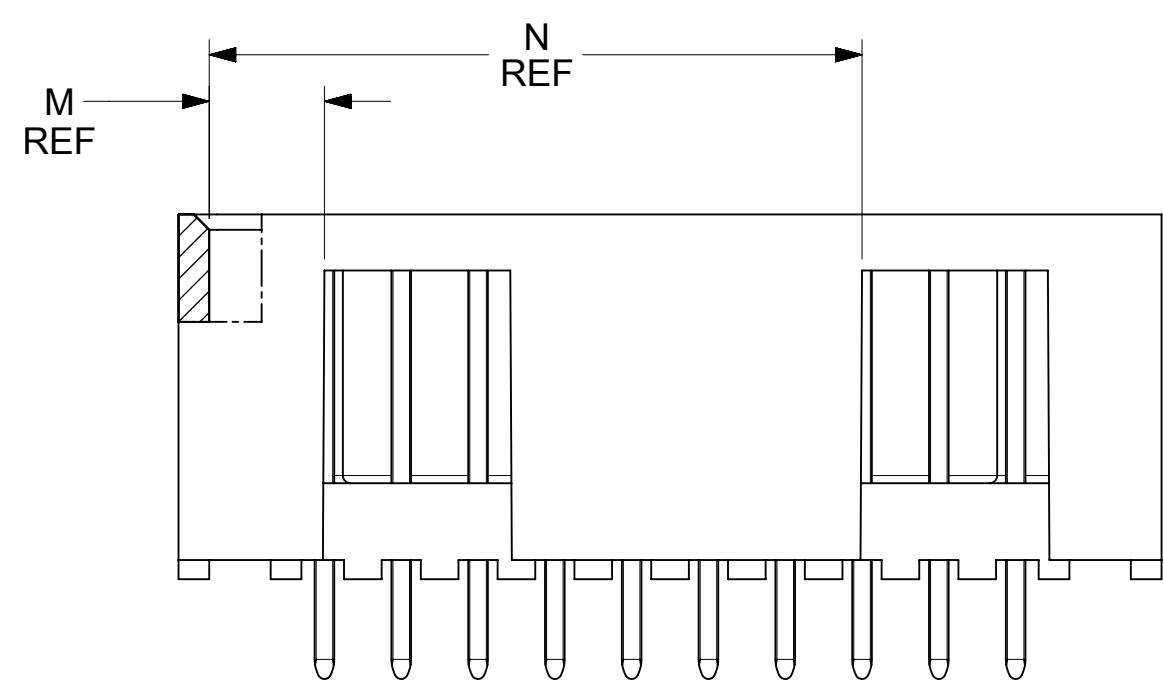
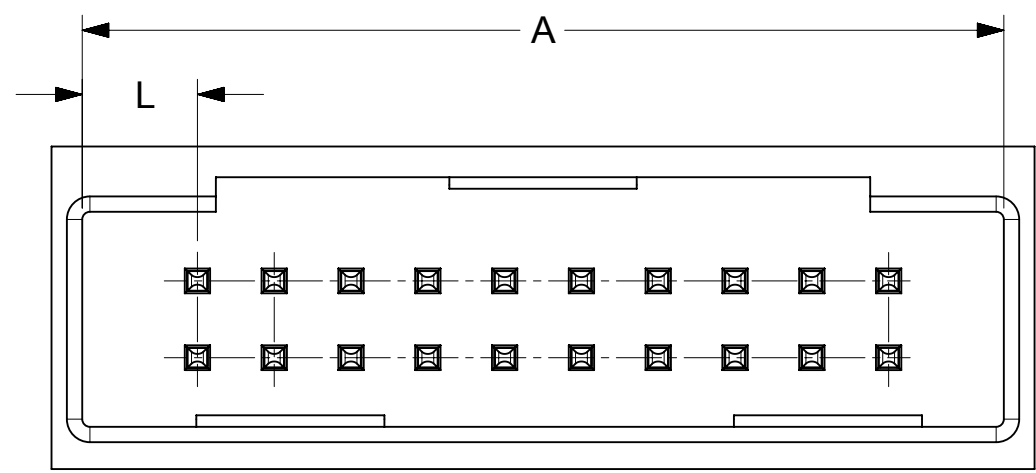
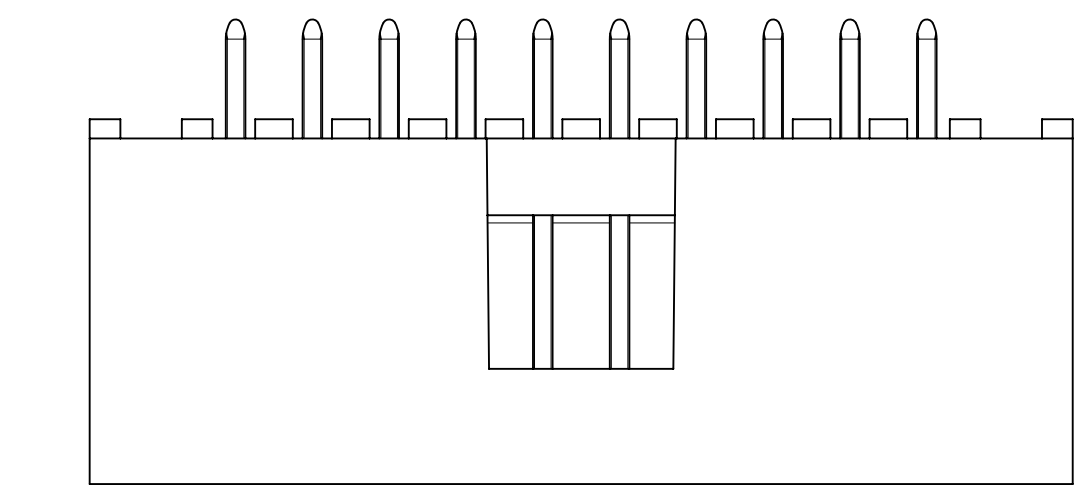
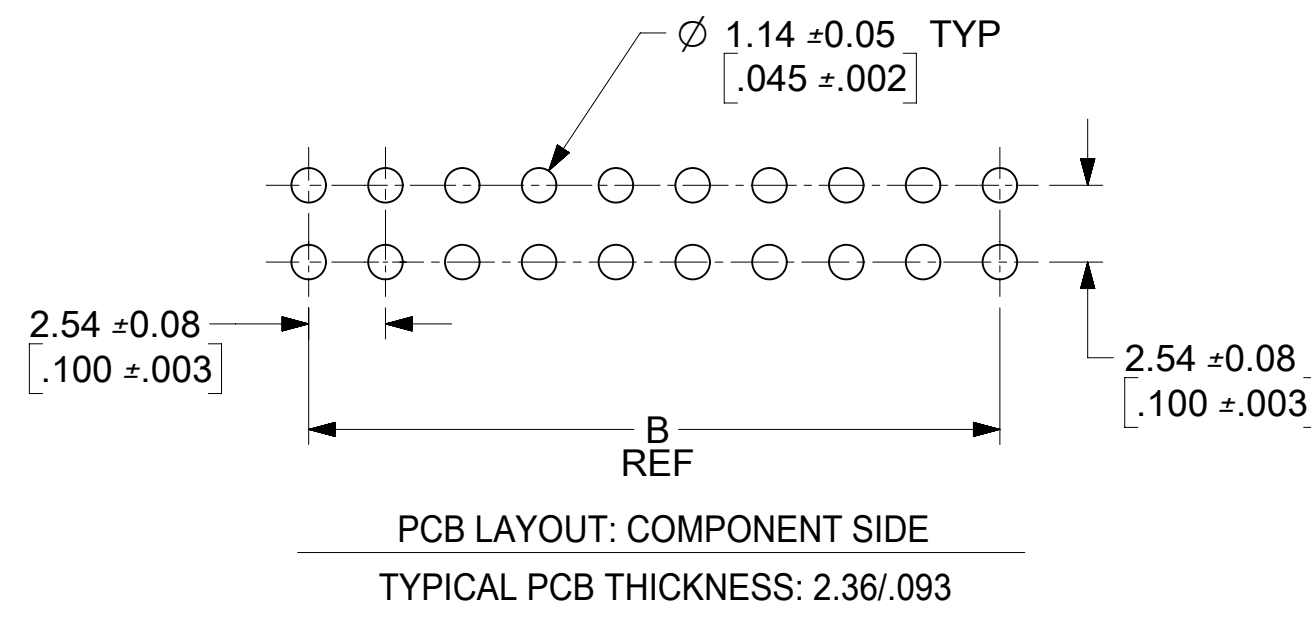

OPTION B  
SAME AS OPTION A  
EXCEPT AS SHOWN

CKT	DIM A	DIM B	DIM L	DIM M	DIM N
06	12.70	5.08	3.81	3.81	
	.500	.200	.150	.150	
08	15.24	7.62	3.81	3.81	
	.600	.300	.150	.150	
10	17.78	10.16	3.81	6.35	
	.700	.400	.150	.150	
12	20.32	12.70	3.81	6.35	
	.800	.500	.150	.150	
14	22.86	15.24	3.81	8.89	
	.900	.600	.150	.350	
16	25.40	17.78	3.81	8.89	
	1.000	.700	.150	.350	
18	27.94	20.32	3.81	11.43	
	1.100	.800	.150	.450	
20	30.48	22.86	3.81	3.81	21.59
	1.200	.900	.150	.150	.850
22	33.02	25.40	3.81	3.81	24.13
	1.300	1.000	.150	.150	.950
24	35.56	27.94	3.81	3.81	26.67
	1.400	1.100	.150	.150	1.050
26	38.10	30.48	3.81	3.81	29.21
	1.500	1.200	.150	.150	1.150
28	40.64	33.02	3.81	3.81	31.75
	1.600	1.300	.150	.150	1.250
30	43.18	35.56	3.81	3.81	34.29
	1.700	1.400	.150	.150	1.350
32	45.72	38.10	3.81	3.81	36.83
	1.800	1.500	.150	.150	1.450
34	48.26	40.64	3.81	3.81	39.37
	1.900	1.600	.150	.150	1.550
36	50.80	43.18	3.81	3.81	41.91
	2.000	1.700	.150	.150	1.650
38	53.34	45.72	3.81	3.81	44.45
	2.100	1.800	.150	.150	1.750
40	55.88	48.26	3.81	3.81	46.99
	2.200	1.900	.150	.150	1.850
42	58.42	50.80	3.81	3.81	49.53
	2.300	2.000	.150	.150	1.950
44	60.96	53.34	3.81	3.81	52.07
	2.400	2.100	.150	.150	2.050
46	63.50	55.88	3.81	3.81	54.61
	2.500	2.200	.150	.150	2.150
48	66.04	58.42	3.81	3.81	57.15
	2.600	2.300	.150	.150	2.250
50	68.58	60.96	3.81	3.81	59.69
	2.700	2.400	.150	.150	2.350
52	71.12	63.50	3.81	3.81	62.23
	2.800	2.500	.150	.150	2.450
54	73.66	66.04	3.81	3.81	64.77
	2.900	2.600	.150	.150	2.550
56	76.20	68.58	3.81	3.81	67.31
	3.000	2.700	.150	.150	2.650
58	78.74	71.12	3.81	3.81	69.85
	3.100	2.800	.150	.150	2.750
60	81.28	73.66	3.81	3.81	72.32
	3.200	2.900	.150	.150	2.850
62	83.82	76.20	3.81	3.81	74.93
	3.300	3.000	.150	.150	2.950
64	86.36	78.74	3.81	3.81	77.47
	3.400	3.100	.150	.150	3.050
66	88.90	81.28	3.81	3.81	80.01
	3.500	3.200	.150	.150	3.150
68	91.44	83.82	3.81	3.81	82.55
	3.600	3.300	.150	.150	3.250
70	93.98	86.36	3.81	3.81	85.09
	3.700	3.400	.150	.150	3.350
72	96.52	88.90	3.81	3.81	87.63
	3.800	3.500	.150	.150	3.450

<b>SYMBOLS</b> DIMENSION UNITS: MM, INCH SCALE: 1:1 CURRENT REV DESC: EC NO: 637057 DRWN: ABABUPS 2020/05/05 CHK'D: MRAMAKRISHNA 2020/05/06 APPR: MRAMAKRISHNA 2020/05/06 INITIAL REVISION: DRWN: APPR: THIRD ANGLE PROJECTION DRAWING: C-SIZE SERIES: 70567 MATERIAL NUMBER: SDA-70567-XXXX CUSTOMER: GENERAL MARKET SHEET NUMBER: 2 OF 8	THIS DRAWING CONTAINS INFORMATION THAT IS PROPRIETARY TO MOLEX ELECTRONIC TECHNOLOGIES, LLC AND SHOULD NOT BE USED WITHOUT WRITTEN PERMISSION	 4 SIDES SHROUDED HEADER HIGH TEMP, (2.54)/.100 GRID W/ (0.64)/.025 PINS PRODUCT CUSTOMER DRAWING DOCUMENT NUMBER: SDA-70567-XXXX DOC TYPE: PSD DOC PART: 001 REVISION: K5
	GENERAL TOLERANCES (UNLESS SPECIFIED) 4 PLACES ± .13 ± 0.01 3 PLACES ± .13 ± 0.01 2 PLACES ± .13 ± 0.01 1 PLACE ± .25 ± 0 PLACES ± ± ANGULAR TOL ± 0.5° DRAFT WHERE APPLICABLE MUST REMAIN WITHIN DIMENSIONS	
	DIMENSION UNITS: MM, INCH SCALE: 1:1	
	CURRENT REV DESC: EC NO: 637057 DRWN: ABABUPS 2020/05/05 CHK'D: MRAMAKRISHNA 2020/05/06 APPR: MRAMAKRISHNA 2020/05/06	
	INITIAL REVISION: DRWN: APPR:	
	THIRD ANGLE PROJECTION DRAWING: C-SIZE SERIES: 70567	
	MATERIAL NUMBER: SDA-70567-XXXX CUSTOMER: GENERAL MARKET SHEET NUMBER: 2 OF 8	
	DOCUMENT NUMBER: SDA-70567-XXXX DOC TYPE: PSD DOC PART: 001 REVISION: K5	
	THIS DRAWING CONTAINS INFORMATION THAT IS PROPRIETARY TO MOLEX ELECTRONIC TECHNOLOGIES, LLC AND SHOULD NOT BE USED WITHOUT WRITTEN PERMISSION	
	DIMENSION UNITS: MM, INCH SCALE: 1:1	



ENGINEERING NUMBER A-70567	MANUFACTURE RELEASE STATUS	E REF.	C .015 ± (0.38)	CONNECTOR END PLATING		P.C. BOARD END PLATING		PACKAGING INFORMATION PK-70873-
				TYPE	D MEAS.	TYPE	F MEAS.	
-0001/-0034	R.F.M.	.130 (3.30)	.315 (8.00)	TIN	.100 (2.54)	TIN	.050 (1.27)	0018
-0035/-0068	R.F.M.	.200 (5.08)	.315 (8.00)	TIN	.100 (2.54)	TIN	.050 (1.27)	0018
-0069/-0102	R.F.M.	.130 (3.30)	.315 (8.00)	15 GOLD	.100 (2.54)	TIN	.050 (1.27)	0018
-0103/-0136	R.F.M.	.200 (5.08)	.315 (8.00)	15 GOLD	.100 (2.54)	TIN	.050 (1.27)	0018
-0137/-0170	R.F.M.	.130 (3.30)	.315 (8.00)	30 GOLD	.100 (2.54)	TIN	.050 (1.27)	0018
-0171/-0204	R.F.M.	.200 (5.08)	.315 (8.00)	30 GOLD	.100 (2.54)	TIN	.050 (1.27)	0018

NO. OF CKTS	OPTION "A"		OPTION "A"		OPTION "A"		OPTION "A"		OPTION "A"		OPTION "A"								NO. OF CKTS
	EDP NUMBER	ENG NUMBER	EDP NUMBER	ENG NUMBER	EDP NUMBER	ENG NUMBER	EDP NUMBER	ENG NUMBER	EDP NUMBER	ENG NUMBER	EDP NUMBER	ENG NUMBER	EDP NUMBER	ENG NUMBER	EDP NUMBER	ENG NUMBER	EDP NUMBER	ENG NUMBER	
06	15-80-0061	A-70567-0001	70567-0035	A-70567-0035	15-80-0063	A-70567-0069	70567-0103	A-70567-0103	15-80-0065	A-70567-0137	70567-0171	A-70567-0171							06
08	15-80-0081	A-70567-0002	70567-0036	A-70567-0036	15-80-0083	A-70567-0070	70567-0104	A-70567-0104	15-80-0085	A-70567-0138	70567-0172	A-70567-0172							08
10	15-80-0101	A-70567-0003	70567-0037	A-70567-0037	15-80-0103	A-70567-0071	70567-0105	A-70567-0105	15-80-0105	A-70567-0139	70567-0173	A-70567-0173							10
12	15-80-0121	A-70567-0004	70567-0038	A-70567-0038	15-80-0123	A-70567-0072	70567-0106	A-70567-0106	15-80-0125	A-70567-0140	70567-0174	A-70567-0174							12
14	15-80-0141	A-70567-0005	70567-0039	A-70567-0039	15-80-0143	A-70567-0073	70567-0107	A-70567-0107	15-80-0145	A-70567-0141	70567-0175	A-70567-0175							14
16	15-80-0161	A-70567-0006	70567-0040	A-70567-0040	15-80-0163	A-70567-0074	70567-0108	A-70567-0108	15-80-0165	A-70567-0142	70567-0176	A-70567-0176							16
18	15-80-0181	A-70567-0007	70567-0041	A-70567-0041	15-80-0183	A-70567-0075	70567-0109	A-70567-0109	15-80-0185	A-70567-0143	70567-0177	A-70567-0177							18
20	15-80-0201	A-70567-0008	70567-0042	A-70567-0042	15-80-0203	A-70567-0076	70567-0110	A-70567-0110	15-80-0205	A-70567-0144	70567-0178	A-70567-0178							20
22	15-80-0221	A-70567-0009	70567-0043	A-70567-0043	15-80-0223	A-70567-0077	70567-0111	A-70567-0111	15-80-0225	A-70567-0145	70567-0179	A-70567-0179							22
24	15-80-0241	A-70567-0010	70567-0044	A-70567-0044	15-80-0243	A-70567-0078	70567-0112	A-70567-0112	15-80-0245	A-70567-0146	70567-0180	A-70567-0180							24
26	15-80-0261	A-70567-0011	70567-0045	A-70567-0045	15-80-0263	A-70567-0079	70567-0113	A-70567-0113	15-80-0265	A-70567-0147	70567-0181	A-70567-0181							26
28	15-80-0281	A-70567-0012	70567-0046	A-70567-0046	15-80-0283	A-70567-0080	70567-0114	A-70567-0114	15-80-0285	A-70567-0148	70567-0182	A-70567-0182							28
30	15-80-0301	A-70567-0013	70567-0047	A-70567-0047	15-80-0303	A-70567-0081	70567-0115	A-70567-0115	15-80-0305	A-70567-0149	70567-0183	A-70567-0183							30
32	15-80-0321	A-70567-0014	70567-0048	A-70567-0048	15-80-0323	A-70567-0082	70567-0116	A-70567-0116	15-80-0325	A-70567-0150	70567-0184	A-70567-0184							32
34	15-80-0341	A-70567-0015	70567-0049	A-70567-0049	15-80-0343	A-70567-0083	70567-0117	A-70567-0117	15-80-0345	A-70567-0151	70567-0185	A-70567-0185							34
36	15-80-0361	A-70567-0016	70567-0050	A-70567-0050	15-80-0363	A-70567-0084	70567-0118	A-70567-0118	15-80-0365	A-70567-0152	70567-0186	A-70567-0186							36
38	15-80-0381	A-70567-0017	70567-0051	A-70567-0051	15-80-0383	A-70567-0085	70567-0119	A-70567-0119	15-80-0385	A-70567-0153	70567-0187	A-70567-0187							38
40	15-80-0401	A-70567-0018	70567-0052	A-70567-0052	15-80-0403	A-70567-0086	70567-0120	A-70567-0120	15-80-0405	A-70567-0154	70567-0188	A-70567-0188							40
42	15-80-0421	A-70567-0019	70567-0053	A-70567-0053	15-80-0423	A-70567-0087	70567-0121	A-70567-0121	15-80-0425	A-70567-0155	70567-0189	A-70567-0189							42
44	15-80-0441	A-70567-0020	70567-0054	A-70567-0054	15-80-0443	A-70567-0088	70567-0122	A-70567-0122	15-80-0445	A-70567-0156	70567-0190	A-70567-0190							44
46	15-80-0461	A-70567-0021	70567-0055	A-70567-0055	15-80-0463	A-70567-0089	70567-0123	A-70567-0123	15-80-0465	A-70567-0157	70567-0191	A-70567-0191							46
48	15-80-0481	A-70567-0022	70567-0056	A-70567-0056	15-80-0483	A-70567-0090	70567-0124	A-70567-0124	15-80-0485	A-70567-0158	70567-0192	A-70567-0192							48
50	15-80-0501	A-70567-0023	70567-0057	A-70567-0057	15-80-0503	A-70567-0091	70567-0125	A-70567-0125	15-80-0505	A-70567-0159	70567-0193	A-70567-0193							50
52	15-80-0521	A-70567-0024	70567-0058	A-70567-0058	15-80-0523	A-70567-0092	70567-0126	A-70567-0126	15-80-0525	A-70567-0160	70567-0194	A-70567-0194							52
54	15-80-0541	A-70567-0025	70567-0059	A-70567-0059	15-80-0543	A-70567-0093	70567-0127	A-70567-0127	15-80-0545	A-70567-0161	70567-0195	A-70567-0195							54
56	15-80-0561	A-70567-0026	70567-0060	A-70567-0060	15-80-0563	A-70567-0094	70567-0128	A-70567-0128	15-80-0565	A-70567-0162	70567-0196	A-70567-0196							56
58	15-80-0581	A-70567-0027	70567-0061	A-70567-0061	15-80-0583	A-70567-0095	70567-0129	A-70567-0129	15-80-0585	A-70567-0163	70567-0197	A-70567-0197							58
60	15-80-0601	A-70567-0028	70567-0062	A-70567-0062	15-80-0603	A-70567-0096	70567-0130	A-70567-0130	15-80-0605	A-70567-0164	70567-0198	A-70567-0198							60
62	15-80-0621	A-70567-0029	70567-0063	A-70567-0063	15-80-0623	A-70567-0097	70567-0131	A-70567-0131	15-80-0625	A-70567-0165	70567-0199	A-70567-0199							62
64	15-80-0641	A-70567-0030	70567-0064	A-70567-0064	15-80-0643	A-70567-0098	70567-0132	A-70567-0132	15-80-0645	A-70567-0166	70567-0200	A-70567-0200							64
66	15-80-0661	A-70567-0031	70567-0065	A-70567-0065	15-80-0663	A-70567-0099	70567-0133	A-70567-0133	15-80-0665	A-70567-0167	70567-0201	A-70567-0201							66
68	15-80-0681	A-70567-0032	70567-0066	A-70567-0066	15-80-0683	A-70567-0100	70567-0134	A-70567-0134	15-80-0685	A-70567-0168	70567-0202	A-70567-0202							68
70	15-80-0701	A-70567-0033	70567-0067	A-70567-0067	15-80-0703	A-70567-0101	70567-0135	A-70567-0135	15-80-0705	A-70567-0169	70567-0203	A-70567-0203							70
72	15-80-0721	A-70567-0034	70567-0068	A-70567-0068	15-80-0723	A-70567-0102	70567-0136	A-70567-0136	15-80-0725	A-70567-0170	70567-0204	A-70567-0204							72

THIS DRAWING CONTAINS INFORMATION THAT IS PROPRIETARY TO MOLEX ELECTRONIC TECHNOLOGIES, LLC AND SHOULD NOT BE USED WITHOUT WRITTEN PERMISSION

**SYMBOLS**

▽ = 0	MM	SCALE 1:1	CURRENT REV DESC:
▽ = 0	GENERAL TOLERANCES (UNLESS SPECIFIED)		
▽ = 0	MM	INCH	EC NO: 637057 DRWN: ABABUPS 2020/05/05 CHK'D: MRAMAKRISHNA 2020/05/06 APPR: MRAMAKRISHNA 2020/05/06
▽ = 0	4 PLACES ±	±	
▽ = 0	3 PLACES ±	± 0.005	INITIAL REVISION: DRWN: APPR:
▽ = 0	2 PLACES ±	± 0.13 ± 0.01	
▽ = 0	1 PLACE ±	± 0.25 ±	THIRD ANGLE PROJECTION DRAWING SERIES D-SIZE 70567
▽ = 0	0 PLACES ±	±	
▽ = 0	ANGULAR TOL ±	± 0.5°	MATERIAL NUMBER CUSTOMER SHEET NUMBER SDA-70567-XXXX PSD 001 K5 GENERAL MARKET 4 OF 8
▽ = 0	DRAFT WHERE APPLICABLE MUST REMAIN WITHIN DIMENSIONS		

4 SIDES SHROUDED HEADER  
HIGH TEMP, (2.54)/.100 GRID W/ (0.64)/.025 PINS

PRODUCT CUSTOMER DRAWING

DOCUMENT NUMBER: SDA-70567-XXXX | DOC TYPE: PSD | DOC PART: 001 | REVISION: K5

ENGINEERING NUMBER A-70567	MANUFACTURE RELEASE STATUS	E REF.	C .015 ± (0.38)	CONNECTOR END PLATING		P.C. BOARD END PLATING		PACKAGING INFORMATION PK-70873-
				TYPE	D MEAS.	TYPE	F MEAS.	
-0205/-0238	R.F.M.	.130 (3.30)	.315 (8.00)	TIN	.100 (2.54)	TIN	.050 (1.27)	0018
-0239/-0272	R.F.M.	.200 (5.08)	.315 (8.00)	TIN	.100 (2.54)	TIN	.050 (1.27)	0018
-0273/-0306	R.F.M.	.130 (3.30)	.315 (8.00)	15 GOLD	.100 (2.54)	TIN	.050 (1.27)	0018
-0307/-0340	R.F.M.	.200 (5.08)	.315 (8.00)	15 GOLD	.100 (2.54)	TIN	.050 (1.27)	0018
-0341/-0374	R.F.M.	.130 (3.30)	.315 (8.00)	30 GOLD	.100 (2.54)	TIN	.050 (1.27)	0018
-0375/-0408	R.F.M.	.200 (5.08)	.315 (8.00)	30 GOLD	.100 (2.54)	TIN	.050 (1.27)	0018

NO. OF CKTS	OPTION "B"		OPTION "B"		OPTION "B"		OPTION "B"		OPTION "B"		OPTION "B"								NO. OF CKTS
	EDP NUMBER	ENG NUMBER	EDP NUMBER	ENG NUMBER	EDP NUMBER	ENG NUMBER	EDP NUMBER	ENG NUMBER	EDP NUMBER	ENG NUMBER	EDP NUMBER	ENG NUMBER	EDP NUMBER	ENG NUMBER	EDP NUMBER	ENG NUMBER	EDP NUMBER	ENG NUMBER	
06	15-80-0067	A-70567-0205	70567-0239	A-70567-0239	15-80-0069	A-70567-0273	70567-0307	A-70567-0307	15-80-1061	A-70567-0341	70567-0375	A-70567-0375							06
08	15-80-0087	A-70567-0206	70567-0240	A-70567-0240	15-80-0089	A-70567-0274	70567-0308	A-70567-0308	15-80-1081	A-70567-0342	70567-0376	A-70567-0376							08
10	15-80-0107	A-70567-0207	70567-0241	A-70567-0241	15-80-0109	A-70567-0275	70567-0309	A-70567-0309	15-80-1101	A-70567-0343	70567-0377	A-70567-0377							10
12	15-80-0127	A-70567-0208	70567-0242	A-70567-0242	15-80-0129	A-70567-0276	70567-0310	A-70567-0310	15-80-1121	A-70567-0344	70567-0378	A-70567-0378							12
14	15-80-0147	A-70567-0209	70567-0243	A-70567-0243	15-80-0149	A-70567-0277	70567-0311	A-70567-0311	15-80-1141	A-70567-0345	70567-0379	A-70567-0379							14
16	15-80-0167	A-70567-0210	70567-0244	A-70567-0244	15-80-0169	A-70567-0278	70567-0312	A-70567-0312	15-80-1161	A-70567-0346	70567-0380	A-70567-0380							16
18	15-80-0187	A-70567-0211	70567-0245	A-70567-0245	15-80-0189	A-70567-0279	70567-0313	A-70567-0313	15-80-1181	A-70567-0347	70567-0381	A-70567-0381							18
20	15-80-0207	A-70567-0212	70567-0246	A-70567-0246	15-80-0209	A-70567-0280	70567-0314	A-70567-0314	15-80-1201	A-70567-0348	70567-0382	A-70567-0382							20
22	15-80-0227	A-70567-0213	70567-0247	A-70567-0247	15-80-0229	A-70567-0281	70567-0315	A-70567-0315	15-80-1221	A-70567-0349	70567-0383	A-70567-0383							22
24	15-80-0247	A-70567-0214	70567-0248	A-70567-0248	15-80-0249	A-70567-0282	70567-0316	A-70567-0316	15-80-1241	A-70567-0350	70567-0384	A-70567-0384							24
26	15-80-0267	A-70567-0215	70567-0249	A-70567-0249	15-80-0269	A-70567-0283	70567-0317	A-70567-0317	15-80-1261	A-70567-0351	70567-0385	A-70567-0385							26
28	15-80-0287	A-70567-0216	70567-0250	A-70567-0250	15-80-0289	A-70567-0284	70567-0318	A-70567-0318	15-80-1281	A-70567-0352	70567-0386	A-70567-0386							28
30	15-80-0307	A-70567-0217	70567-0251	A-70567-0251	15-80-0309	A-70567-0285	70567-0319	A-70567-0319	15-80-1301	A-70567-0353	70567-0387	A-70567-0387							30
32	15-80-0327	A-70567-0218	70567-0252	A-70567-0252	15-80-0329	A-70567-0286	70567-0320	A-70567-0320	15-80-1321	A-70567-0354	70567-0388	A-70567-0388							32
34	15-80-0347	A-70567-0219	70567-0253	A-70567-0253	15-80-0349	A-70567-0287	70567-0321	A-70567-0321	15-80-1341	A-70567-0355	70567-0389	A-70567-0389							34
36	15-80-0367	A-70567-0220	70567-0254	A-70567-0254	15-80-0369	A-70567-0288	70567-0322	A-70567-0322	15-80-1361	A-70567-0356	70567-0390	A-70567-0390							36
38	15-80-0387	A-70567-0221	70567-0255	A-70567-0255	15-80-0389	A-70567-0289	70567-0323	A-70567-0323	15-80-1381	A-70567-0357	70567-0391	A-70567-0391							38
40	15-80-0407	A-70567-0222	70567-0256	A-70567-0256	15-80-0409	A-70567-0290	70567-0324	A-70567-0324	15-80-1401	A-70567-0358	70567-0392	A-70567-0392							40
42	15-80-0427	A-70567-0223	70567-0257	A-70567-0257	15-80-0429	A-70567-0291	70567-0325	A-70567-0325	15-80-1421	A-70567-0359	70567-0393	A-70567-0393							42
44	15-80-0447	A-70567-0224	70567-0258	A-70567-0258	15-80-0449	A-70567-0292	70567-0326	A-70567-0326	15-80-1441	A-70567-0360	70567-0394	A-70567-0394							44
46	15-80-0467	A-70567-0225	70567-0259	A-70567-0259	15-80-0469	A-70567-0293	70567-0327	A-70567-0327	15-80-1461	A-70567-0361	70567-0395	A-70567-0395							46
48	15-80-0487	A-70567-0226	70567-0260	A-70567-0260	15-80-0489	A-70567-0294	70567-0328	A-70567-0328	15-80-1481	A-70567-0362	70567-0396	A-70567-0396							48
50	15-80-0507	A-70567-0227	70567-0261	A-70567-0261	15-80-0509	A-70567-0295	70567-0329	A-70567-0329	15-80-1501	A-70567-0363	70567-0397	A-70567-0397							50
52	15-80-0527	A-70567-0228	70567-0262	A-70567-0262	15-80-0529	A-70567-0296	70567-0330	A-70567-0330	15-80-1521	A-70567-0364	70567-0398	A-70567-0398							52
54	15-80-0547	A-70567-0229	70567-0263	A-70567-0263	15-80-0549	A-70567-0297	70567-0331	A-70567-0331	15-80-1541	A-70567-0365	70567-0399	A-70567-0399							54
56	15-80-0567	A-70567-0230	70567-0264	A-70567-0264	15-80-0569	A-70567-0298	70567-0332	A-70567-0332	15-80-1561	A-70567-0366	70567-0400	A-70567-0400							56
58	15-80-0587	A-70567-0231	70567-0265	A-70567-0265	15-80-0589	A-70567-0299	70567-0333	A-70567-0333	15-80-1581	A-70567-0367	70567-0401	A-70567-0401							58
60	15-80-0607	A-70567-0232	70567-0266	A-70567-0266	15-80-0609	A-70567-0300	70567-0334	A-70567-0334	15-80-1601	A-70567-0368	70567-0402	A-70567-0402							60
62	15-80-0627	A-70567-0233	70567-0267	A-70567-0267	15-80-0629	A-70567-0301	70567-0335	A-70567-0335	15-80-1621	A-70567-0369	70567-0403	A-70567-0403							62
64	15-80-0647	A-70567-0234	70567-0268	A-70567-0268	15-80-0649	A-70567-0302	70567-0336	A-70567-0336	15-80-1641	A-70567-0370	70567-0404	A-70567-0404							64
66	15-80-0667	A-70567-0235	70567-0269	A-70567-0269	15-80-0669	A-70567-0303	70567-0337	A-70567-0337	15-80-1661	A-70567-0371	70567-0405	A-70567-0405							66
68	15-80-0687	A-70567-0236	70567-0270	A-70567-0270	15-80-0689	A-70567-0304	70567-0338	A-70567-0338	15-80-1681	A-70567-0372	70567-0406	A-70567-0406							68
70	15-80-0707	A-70567-0237	70567-0271	A-70567-0271	15-80-0709	A-70567-0305	70567-0339	A-70567-0339	15-80-1701	A-70567-0373	70567-0407	A-70567-0407							70
72	15-80-0727	A-70567-0238	70567-0272	A-70567-0272	15-80-0729	A-70567-0306	70567-0340	A-70567-0340	15-80-1721	A-70567-0374	70567-0408	A-70567-0408							72

THIS DRAWING CONTAINS INFORMATION THAT IS PROPRIETARY TO MOLEX ELECTRONIC TECHNOLOGIES, LLC AND SHOULD NOT BE USED WITHOUT WRITTEN PERMISSION

**SYMBOLS**

▽ = 0	MM	SCALE	1:1
▽ = 0	GENERAL TOLERANCES (UNLESS SPECIFIED)		
▽ = 0		MM	INCH
▽ = 0	4 PLACES ±	±	
▽ = 0	3 PLACES ±	± 0.005	
▽ = 0	2 PLACES ±	0.13 ± 0.01	
▽ = 0	1 PLACE ±	0.25 ±	
▽ = 0	0 PLACES ±	±	
▽ = 0	ANGULAR TOL	± 0.5°	
▽ = 0	DRAFT WHERE APPLICABLE MUST REMAIN WITHIN DIMENSIONS		
▽ = 0	THIRD ANGLE PROJECTION	DRAWING	SERIES
		D-SIZE	70567

CURRENT REV DESC:

EC NO: 637057  
 DRWN: ABABUPS 2020/05/05  
 CHK'D: MRAMAKRISHNA 2020/05/06  
 APPR: MRAMAKRISHNA 2020/05/06

INITIAL REVISION:  
 DRWN:  
 APPR:

**molex**

4 SIDES SHROUDED HEADER  
 HIGH TEMP, (2.54)/.100 GRID W/ (0.64)/.025 PINS

PRODUCT CUSTOMER DRAWING

DOCUMENT NUMBER	DOC TYPE	DOC PART	REVISION
SDA-70567-XXXX	PSD	001	K5

MATERIAL NUMBER CUSTOMER SHEET NUMBER  
 GENERAL MARKET 5 OF 8

ENGINEERING NUMBER A-70567	MANUFACTURING RELEASE STATUS	E REF.	C ± 0.015 (0.38)	CONNECTOR END PLATING		P.C. BOARD END PLATING		PACKAGING INFORMATION PK-70873-
				TYPE	D MEAS.	TYPE	F MEAS.	
-0409/-0442	R.F.M	.130 (3.30)	.315 (8.00)	TIN	.100 (2.54)	TIN	.050 (1.27)	0018
-0443/-0476	R.F.M	.200 (5.08)	.315 (8.00)	TIN	.100 (2.54)	TIN	.050 (1.27)	0018
-0477/-0510	R.F.M	.130 (3.30)	.315 (8.00)	GOLD	.100 (2.54)	TIN	.050 (1.27)	0018
-0511/-0544	R.F.M	.200 (5.08)	.315 (8.00)	GOLD	.100 (2.54)	TIN	.050 (1.27)	0018
-0545/-0578	R.F.M	.130 (3.30)	.315 (8.00)	GOLD	.100 (2.54)	TIN	.050 (1.27)	0018
-0579/-0612	R.F.M	.200 (5.08)	.315 (8.00)	GOLD	.100 (2.54)	TIN	.050 (1.27)	0018





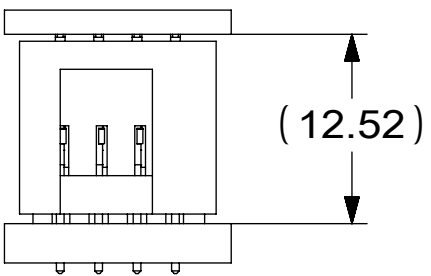

NO. OF CKTS	OPTION "C"		OPTION "C"		OPTION "C"		OPTION "C"		OPTION "C"		OPTION "C"								NO. OF CKTS
	EDP NUMBER	ENG NUMBER	EDP NUMBER	ENG NUMBER	EDP NUMBER	ENG NUMBER	EDP NUMBER	ENG NUMBER	EDP NUMBER	ENG NUMBER	EDP NUMBER	ENG NUMBER	EDP NUMBER	ENG NUMBER	EDP NUMBER	ENG NUMBER	EDP NUMBER	ENG NUMBER	
06	15-80-1062	A-70567-0409	AX-70567-0443	15-80-1063	A-70567-0477	AX-70567-0511	15-80-1064	A-70567-0545	AX-70567-0579									06	
08	15-80-1082	A-70567-0410	AX-70567-0444	15-80-1083	A-70567-0478	AX-70567-0512	15-80-1084	A-70567-0546	AX-70567-0580									08	
10	15-80-1102	A-70567-0411	AX-70567-0445	15-80-1103	A-70567-0479	AX-70567-0513	15-80-1104	A-70567-0547	AX-70567-0581									10	
12	15-80-1122	A-70567-0412	AX-70567-0446	15-80-1123	A-70567-0480	AX-70567-0514	15-80-1124	A-70567-0548	AX-70567-0582									12	
14	15-80-1142	A-70567-0413	AX-70567-0447	15-80-1143	A-70567-0481	AX-70567-0515	15-80-1144	A-70567-0549	AX-70567-0583									14	
16	15-80-1162	A-70567-0414	AX-70567-0448	15-80-1163	A-70567-0482	AX-70567-0516	15-80-1164	A-70567-0550	AX-70567-0584									16	
18	15-80-1182	A-70567-0415	AX-70567-0449	15-80-1183	A-70567-0483	AX-70567-0517	15-80-1184	A-70567-0551	AX-70567-0585									18	
20	15-80-1202	A-70567-0416	AX-70567-0450	15-80-1203	A-70567-0484	AX-70567-0518	15-80-1204	A-70567-0552	AX-70567-0586									20	
22	15-80-1222	A-70567-0417	AX-70567-0451	15-80-1223	A-70567-0485	AX-70567-0519	15-80-1224	A-70567-0553	AX-70567-0587									22	
24	15-80-1242	A-70567-0418	AX-70567-0452	15-80-1243	A-70567-0486	AX-70567-0520	15-80-1244	A-70567-0554	AX-70567-0588									24	
26	15-80-1262	A-70567-0419	AX-70567-0453	15-80-1263	A-70567-0487	AX-70567-0521	15-80-1264	A-70567-0555	AX-70567-0589									26	
28	15-80-1282	A-70567-0420	AX-70567-0454	15-80-1283	A-70567-0488	AX-70567-0522	15-80-1284	A-70567-0556	AX-70567-0590									28	
30	15-80-1302	A-70567-0421	AX-70567-0455	15-80-1303	A-70567-0489	AX-70567-0523	15-80-1304	A-70567-0557	AX-70567-0591									30	
32	15-80-1322	A-70567-0422	AX-70567-0456	15-80-1323	A-70567-0490	AX-70567-0524	15-80-1324	A-70567-0558	AX-70567-0592									32	
34	15-80-1342	A-70567-0423	AX-70567-0457	15-80-1343	A-70567-0491	AX-70567-0525	15-80-1344	A-70567-0559	AX-70567-0593									34	
36	15-80-1362	A-70567-0424	AX-70567-0458	15-80-1363	A-70567-0492	AX-70567-0526	15-80-1364	A-70567-0560	AX-70567-0594									36	
38	15-80-1382	A-70567-0425	AX-70567-0459	15-80-1383	A-70567-0493	AX-70567-0527	15-80-1384	A-70567-0561	AX-70567-0595									38	
40	15-80-1402	A-70567-0426	AX-70567-0460	15-80-1403	A-70567-0494	AX-70567-0528	15-80-1404	A-70567-0562	AX-70567-0596									40	
42	15-80-1422	A-70567-0427	AX-70567-0461	15-80-1423	A-70567-0495	AX-70567-0529	15-80-1424	A-70567-0563	AX-70567-0597									42	
44	15-80-1442	A-70567-0428	AX-70567-0462	15-80-1443	A-70567-0496	AX-70567-0530	15-80-1444	A-70567-0564	AX-70567-0598									44	
46	15-80-1462	A-70567-0429	AX-70567-0463	15-80-1463	A-70567-0497	AX-70567-0531	15-80-1464	A-70567-0565	AX-70567-0599									46	
48	15-80-1482	A-70567-0430	AX-70567-0464	15-80-1483	A-70567-0498	AX-70567-0532	15-80-1484	A-70567-0566	AX-70567-0600									48	
50	15-80-1502	A-70567-0431	AX-70567-0465	15-80-1503	A-70567-0499	AX-70567-0533	15-80-1504	A-70567-0567	AX-70567-0601									50	
52	15-80-1522	A-70567-0432	AX-70567-0466	15-80-1523	A-70567-0500	AX-70567-0534	15-80-1524	A-70567-0568	AX-70567-0602									52	
54	15-80-1542	A-70567-0433	AX-70567-0467	15-80-1543	A-70567-0501	AX-70567-0535	15-80-1544	A-70567-0569	AX-70567-0603									54	
56	15-80-1562	A-70567-0434	AX-70567-0468	15-80-1563	A-70567-0502	AX-70567-0536	15-80-1564	A-70567-0570	AX-70567-0604									56	
58	15-80-1582	A-70567-0435	AX-70567-0469	15-80-1583	A-70567-0503	AX-70567-0537	15-80-1584	A-70567-0571	AX-70567-0605									58	
60	15-80-1602	A-70567-0436	AX-70567-0470	15-80-1603	A-70567-0504	AX-70567-0538	15-80-1604	A-70567-0572	AX-70567-0606									60	
62	15-80-1622	A-70567-0437	AX-70567-0471	15-80-1623	A-70567-0505	AX-70567-0539	15-80-1624	A-70567-0573	AX-70567-0607									62	
64	15-80-1642	A-70567-0438	AX-70567-0472	15-80-1643	A-70567-0506	AX-70567-0540	15-80-1644	A-70567-0574	AX-70567-0608									64	
66	15-80-1662	A-70567-0439	AX-70567-0473	15-80-1663	A-70567-0507	AX-70567-0541	15-80-1664	A-70567-0575	AX-70567-0609									66	
68	15-80-1682	A-70567-0440	AX-70567-0474	15-80-1683	A-70567-0508	AX-70567-0542	15-80-1684	A-70567-0576	AX-70567-0610									68	
70	15-80-1702	A-70567-0441	AX-70567-0475	15-80-1703	A-70567-0509	AX-70567-0543	15-80-1704	A-70567-0577	AX-70567-0611									70	
72	15-80-1722	A-70567-0442	AX-70567-0476	15-80-1723	A-70567-0510	AX-70567-0544	15-80-1724	A-70567-0578	AX-70567-0612									72	

SYMBOLS	THIS DRAWING CONTAINS INFORMATION THAT IS PROPRIETARY TO MOLEX ELECTRONIC TECHNOLOGIES, LLC AND SHOULD NOT BE USED WITHOUT WRITTEN PERMISSION		
	DIMENSION UNITS	SCALE	CURRENT REV DESC:
▽ = 0	MM	1:1	
▽ = 0	GENERAL TOLERANCES (UNLESS SPECIFIED)		
▽ = 0		MM	INCH
▽ = 0	4 PLACES	±	±
▽ = 0	3 PLACES	±	± 0.005
▽ = 0	2 PLACES	±	± 0.13 ± 0.01
▽ = 0	1 PLACE	±	± 0.25 ±
▽ = 0	0 PLACES	±	±
▽ = 0	ANGULAR TOL	±	± 0.5 °
▽ = 0	DRAFT WHERE APPLICABLE MUST REMAIN WITHIN DIMENSIONS	THIRD ANGLE PROJECTION	DRAWING SERIES
▽ = 0			D-SIZE 70567
EC NO: 637057			2020/05/05
DRWN: ABABUPS			2020/05/06
CHK'D: MRAMAKRISHNA			2020/05/06
APPR: MRAMAKRISHNA			2020/05/06
INITIAL REVISION:			
DRWN:			
APPR:			
DOCUMENT NUMBER		DOC TYPE	DOC PART
SDA-70567-XXXX		PSD	001
CUSTOMER		REVISION	
GENERAL MARKET		K5	
MATERIAL NUMBER		SHEET NUMBER	
		6 OF 8	

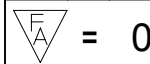
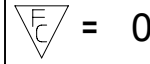
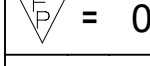
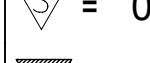

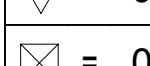
**BOARD TO BOARD (BTB) DISTANCE**

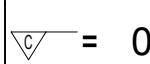
HEADER	MATES WITH (RECEPTACLE)	BTB DIST.	PICTORIAL VIEW
70567	71395	12.52	

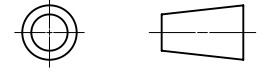
SYMBOLS	THIS DRAWING CONTAINS INFORMATION THAT IS PROPRIETARY TO MOLEX ELECTRONIC TECHNOLOGIES, LLC AND SHOULD NOT BE USED WITHOUT WRITTEN PERMISSION			
	DIMENSION UNITS	SCALE		CURRENT REV DESC:
 = 0	MM	1:1		EC NO: 637057 DRWN: ABABUPS 2020/05/05 CHK'D: MRAMAKRISHNA 2020/05/06 APPR: MRAMAKRISHNA 2020/05/06 INITIAL REVISION: DRWN: APPR:
 = 0	GENERAL TOLERANCES (UNLESS SPECIFIED)			
 = 0		MM	INCH	
 = 0	4 PLACES	±	±	
 = 0	3 PLACES	±	± 0.005	
 = 0	2 PLACES	±	± 0.13 ± 0.01	
 = 0	1 PLACE	±	± 0.25 ±	
 = 0	0 PLACES	±	±	
 = 0	ANGULAR TOL ± 0.5 °			THIRD ANGLE PROJECTION
= 0	DRAFT WHERE APPLICABLE MUST REMAIN WITHIN DIMENSIONS			DRAWING D-SIZE
				SERIES 70567
DOCUMENT STATUS P1		RELEASE DATE 2020/05/06	14:13:05	DOCUMENT NUMBER SDA-70567-XXXX DOC TYPE PSD DOC PART 001 REVISION K5
MATERIAL NUMBER			CUSTOMER GENERAL MARKET	SHEET NUMBER 8 OF 8

## Looking for pricing, stock, or lifecycle information?

Click below to explore more details on WIN SOURCE:

 [View 0015800301 on WIN SOURCE](#)

 [Molex, LLC Information](#)

## Optimize Your Supply Chain with WIN SOURCE Solutions

-  Global Sourcing Solution
-  Obsolete Management
-  Cost Control Management
-  Shortage Management
-  Alternative Solution
-  Excess Inventory Management