



**THE DATASHEET OF
PKU4611ASI**



PKU4600A Series Fully Regulated DC-DC Converters
 Input 36-60 V, Output up to 12 A / 60 W

28701-BMR67601 Rev.C March 2020
 © Flex

Key Features

- Low profile sixteenth-brick
 33.02 x 22.86 x 8.2 mm (1.30 x 0.90 x 0.32 in)
- High efficiency, typ. 94% at 5 Vout half load
- 2250 Vdc input to output isolation
- Meets safety requirements according to IEC/EN/UL 62368-1
- MTBF 5.2 million hours

General Characteristics

- Input under voltage shutdown
- Monotonic start-up
- Output short-circuit protection
- Remote control
- Output voltage adjust function
- Over temperature protection
- Highly automated manufacturing ensures quality
- ISO 9001/14001 certified supplier

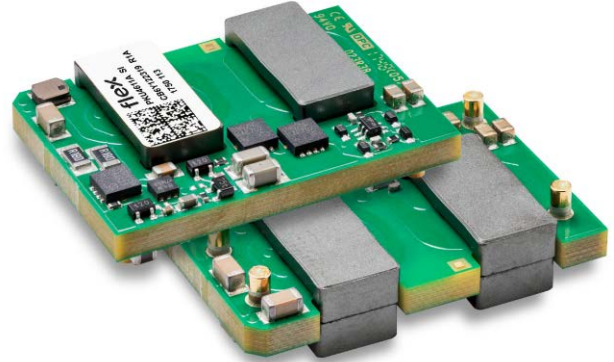

Safety Approvals



Design for Environment



Meets requirements in high-temperature lead-free soldering processes.

Contents

Ordering Information	2
General Information	2
Safety Specification	3
Absolute Maximum Ratings	4
Electrical Specification	
5 V, 12 A / 60 W	PKU4611A 5
6 V, 10 A / 60 W	PKU4617VA 9
EMC Specification	13
Operating Information	14
Thermal Consideration	15
Connections	17
Mechanical Information	18
Soldering Information	19
Delivery Information	21
Product Qualification Specification	22

PKU4600A Series Fully Regulated DC-DC Converters
 Input 36-60 V, Output up to 12 A / 60 W

28701-BMR67601 Rev.C

March 2020

© Flex

Ordering Information

Product program	Output
PKU4611A	5 V, 12 A / 60 W
PKU4617VA	6 V, 10 A / 60 W

Product number and Packaging

PKU461XX n ₁ n ₂ n ₃			
Options	n ₁	n ₂	n ₃
Mounting	o		
Remote Control logic		o	
Delivery package information			o

Options	Description
n ₁	SI Surface mount
n ₂	Negative * Positive
n ₃	/C Tape and Reel

* Standard variant (i.e. no option selected).

General Information
Reliability

The failure rate (λ) and mean time between failures (MTBF = $1/\lambda$) is calculated at max output power and an operating ambient temperature (T_A) of +40°C. Flex Power uses Telcordia SR-332 Issue 4 Method 1 to calculate the mean steady-state failure rate and standard deviation (σ).

Telcordia SR-332 Issue 4 also provides techniques to estimate the upper confidence levels of failure rates based on the mean and standard deviation.

Mean steady-state failure rate, λ	Std. deviation, σ
194 nFailures/h	19.2 nFailures/h

MTBF (mean value) for the PKU4611A series = 5.2 Mh.
 MTBF at 90% confidence level = 4.6 Mh

Compatibility with RoHS requirements

The products are compatible with the relevant clauses and requirements of the RoHS directive 2011/65/EU and have a maximum concentration value of 0.1% by weight in homogeneous materials for lead, mercury, hexavalent chromium, PBB and PBDE and of 0.01% by weight in homogeneous materials for cadmium.

Exemptions in the RoHS directive utilized in Flex Power products are found in the Statement of Compliance document.

Flex Power fulfills and will continuously fulfill all its obligations under regulation (EC) No 1907/2006 concerning the registration, evaluation, authorization and restriction of chemicals (REACH) as they enter into force and is through product materials declarations preparing for the obligations to communicate information on substances in the products.

Quality Statement

The products are designed and manufactured in an industrial environment where quality systems and methods like ISO 9000, Six Sigma, and SPC are intensively in use to boost the continuous improvements strategy. Infant mortality or early failures in the products are screened out and they are subjected to an ATE-based final test. Conservative design rules, design reviews and product qualifications, plus the high competence of an engaged work force, contribute to the high quality of the products.

Warranty

Warranty period and conditions are defined in Flex Power General Terms and Conditions of Sale.

Limitation of Liability

Flex Power does not make any other warranties, expressed or implied including any warranty of merchantability or fitness for a particular purpose (including, but not limited to, use in life support applications, where malfunctions of product can cause injury to a person's health or life).

© Flex 2020

The information and specifications in this technical specification is believed to be correct at the time of publication. However, no liability is accepted for inaccuracies, printing errors or for any consequences thereof. Flex Power reserves the right to change the contents of this technical specification at any time without prior notice.

PKU4600A Series Fully Regulated DC-DC Converters Input 36-60 V, Output up to 12 A / 60 W	28701-BMR67601 Rev.C	March 2020
	© Flex	

Safety Specification

General information

Flex Power DC/DC converters and DC/DC regulators are designed in accordance with the safety standards IEC 62368-1, EN 62368-1 and UL 62368-1 *Audio/video, information and communication technology equipment - Part 1: Safety requirements*

IEC/EN/UL 62368-1 contains requirements to prevent injury or damage due to the following hazards:

- Electrical shock
- Electrically-caused fire
- Injury caused by hazardous substances
- Mechanically-caused injury
- Skin burn
- Radiation-caused injury

On-board DC/DC converters, Power interface modules and DC/DC regulators are defined as component power supplies. As components they cannot fully comply with the provisions of any safety requirements without "conditions of acceptability". Clearance between conductors and between conductive parts of the component power supply and conductors on the board in the final product must meet the applicable safety requirements. Certain conditions of acceptability apply for component power supplies with limited stand-off (see Mechanical Information for further information). It is the responsibility of the installer to ensure that the final product housing these components complies with the requirements of all applicable safety standards and regulations for the final product.

Component power supplies for general use shall comply with the requirements in IEC/EN/UL 62368-1. Product related standards, e.g. IEEE 802.3af *Power over Ethernet*, and ETS-300132-2 *Power interface at the input to telecom equipment, operated by direct current (dc)* are based on IEC/EN/UL 62368-1 with regards to safety.

Flex Power DC/DC converters, Power interface modules and DC/DC regulators are UL 62368-1 recognized and certified in accordance with EN 62368-1. The flammability rating for all construction parts of the products meet requirements for V-0 class material according to IEC 60695-11-10, *Fire hazard testing, test flames – 50 W* horizontal and vertical flame test methods.

Isolated DC/DC converters & Power interface modules

The product may provide basic or functional insulation between input and output according to IEC/EN/UL 62368-1 (see Safety Certificate), different conditions shall be met if the output of a basic or a functional insulated product shall be considered as ES1 energy source.

For basic insulated products (see Safety Certificate) the output is considered as ES1 energy source if one of the following conditions is met:

- The input source provides supplementary or double or reinforced insulation from the AC mains according to IEC/EN/UL 62368-1.
- The input source provides functional or basic insulation from the AC mains and the product's output is reliably connected to protective earth according to IEC/EN/UL 62368-1.

For functional insulated products (see Safety Certificate) the output is considered as ES1 energy source if one of the following conditions is met:

- The input source provides double or reinforced insulation from the AC mains according to IEC/EN/UL 62368-1.
- The input source provides basic or supplementary insulation from the AC mains and the product's output is reliably connected to protective earth according to IEC/EN/UL 62368-1.
- The input source is reliably connected to protective earth and provides basic or supplementary insulation according to IEC/EN/UL 62368-1 and the maximum input source voltage is 60 Vdc.

Galvanic isolation between input and output is verified in an electric strength test and the isolation voltage (V_{iso}) meets the voltage strength requirement for basic insulation according to IEC/EN/UL 62368-1.

It is recommended to use a slow blow fuse at the input of each DC/DC converter. If an input filter is used in the circuit the fuse should be placed in front of the input filter. In the rare event of a component problem that imposes a short circuit on the input source, this fuse will provide the following functions:

- Isolate the fault from the input power source so as not to affect the operation of other parts of the system
- Protect the distribution wiring from excessive current and power loss thus preventing hazardous overheating

PKU4600A Series Fully Regulated DC-DC Converters
 Input 36-60 V, Output up to 12 A / 60 W

28701-BMR67601 Rev.C March 2020
 © Flex

Absolute Maximum Ratings

Characteristics		min	typ	max	Unit
T _{P1}	Operating Temperature (see Thermal Consideration section)	-40		+125	°C
T _S	Storage temperature	-55		+125	°C
V _I	Input voltage	-0.5		+80	V
C _{out}	Output capacitance	270			µF
V _{iso}	Isolation voltage (input to output test voltage)			2250	Vdc
V _{tr}	Input voltage transient according to ETSI EN 300 132-2 and Telcordia GR-1089-CORE			100	V
V _{RC}	Remote Control pin voltage (see Operating Information section)	Positive logic option		6	V
		Negative logic option		6	V

Stresses above those listed under Absolute Maximum Ratings may cause permanent damage to the device. This is a stress rating only; functional operation of the device at these or any other conditions above those indicated in the Electrical Specification section of this specification is not implied. Exposure to absolute maximum rating conditions for extended periods may affect device reliability.

Fundamental Circuit Diagram

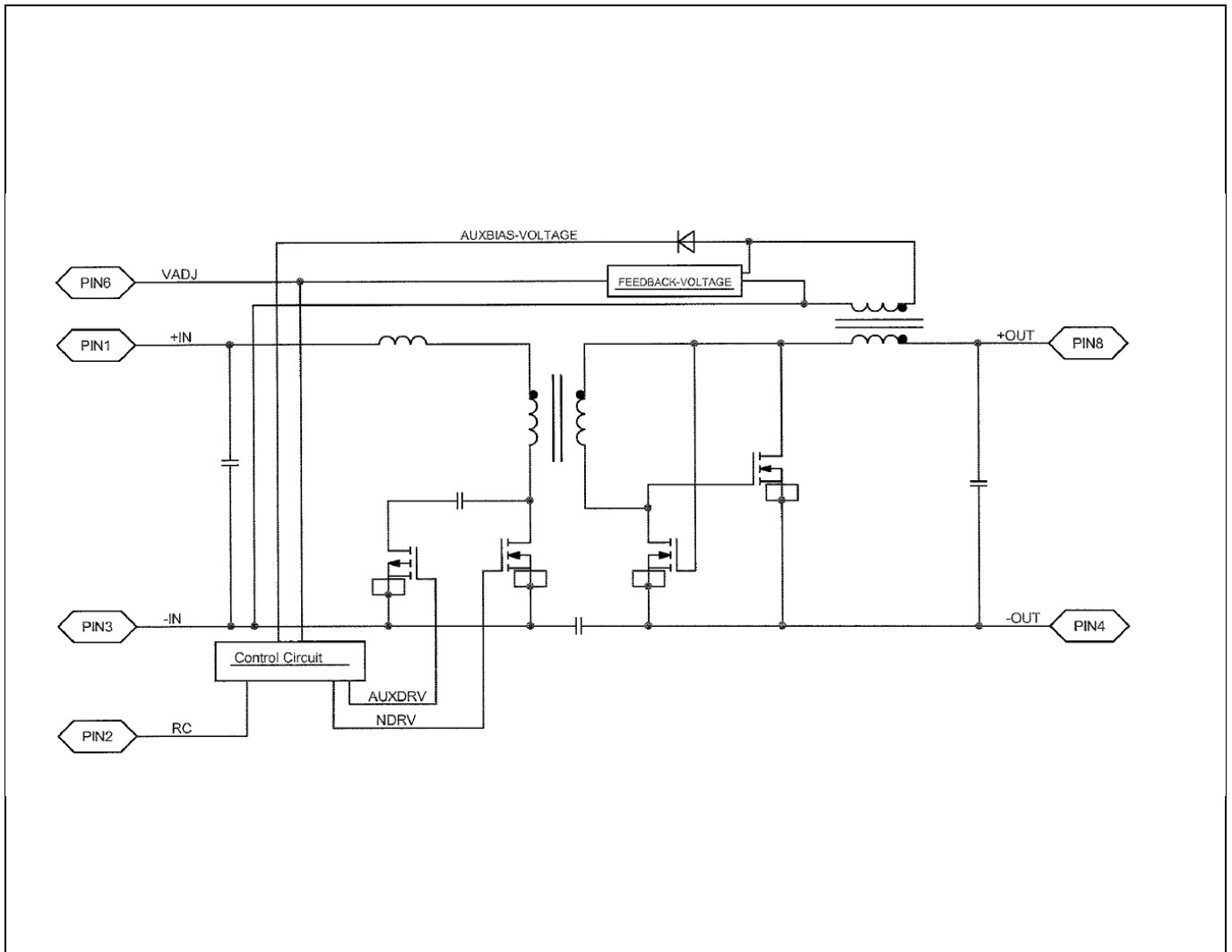

PKU4600A Series Fully Regulated DC-DC Converters
 Input 36-60 V, Output up to 12 A / 60 W

28701-BMR67601 Rev.C

March 2020

© Flex

Electrical Specification
5 V, 12 A / 60 W

PKU4611A

 $T_{P1} = -40$ to $+95^{\circ}\text{C}$, $V_I = 36$ to 60 V, $V_{out} = 5$ V for all table conditions and setting unless otherwise specified under Conditions.

 Typical values given at: $T_{P1} = +25^{\circ}\text{C}$, $V_I = 53$ V max I_O , unless otherwise specified under Conditions.

 Additional $C_{in} = 100$ μF Nichicon, $C_{out} = 270$ μF OS-CON.

Characteristics		Conditions	min	typ	max	Unit
V_I	Input voltage range		36		60	V
V_{loff}	Turn-off input voltage	Decreasing input voltage	31	32	33	V
V_{lon}	Turn-on input voltage	Increasing input voltage	33	34	35	V
C_I	Internal input capacitance	$V_I = 53$ V		3		μF
P_O	Output power Average		0		60	W
η	Efficiency	50% of max I_O		94		%
		max I_O		93		
P_d	Power Dissipation	max I_O		4.8		W
P_{li}	Input idling power	$I_O = 0$ A, $V_I = 53$ V		1		W
P_{RC}	Input standby power	$V_I = 53$ V (turned off with RC)		0.1		W
f_s	Switching frequency	0-100 % of max I_O	280	300	320	kHz

V_{Oi}	Nominally Output voltage initial setting and accuracy	$T_{P1} = +25^{\circ}\text{C}$, $V_I = 53$ V, $I_O = 6$ A		5.05		V
V_O	Output voltage tolerance band	0-100% of max I_O , $V_I = 36$ -60 V	4.81		5.17	V
	Output adjust range	Max $I_O = 10$ A, $P_O = 60$ W, Resistor added V_{adj} -pin to GND-pin for $V_{out} = 6$ V ~ 16 k Ω	5.0		6.0	V
	Idling voltage	$I_O = 0$ A, $V_I = 36$ -60 V		5.1		V
	Line regulation	$V_I = 36$ -60 V, max I_O	-15		+15	mV
	Load regulation	$V_I = 53$ V, 10-100% of max I_O	-130		+130	mV
V_{tr}	Load transient voltage deviation	$V_I = 53$ V, Load step 25-75-25% of max I_O , $di/dt = 0.5$ A/ μs , $C_O = 270$ μF		± 350		mV
t_{tr}	Load transient recovery time			100		μs
t_r	Ramp-up time (from 10-90% of V_{Oi})	10-100% of max I_O		10		ms
t_s	Start-up time (from V_I connection to 90% of V_{Oi})			120		ms
t_{RC}	RC start-up time (from V_{RC} connection to 90% of V_{Oi})	max I_O		10		ms
RC	Sink current, See Note 1	See operating information		0.16		mA
	Trigger level	Enable Threshold		1.22		V
I_O	Output current		0		12	A
I_{lim}	Current limit threshold	$T_{P1} < \text{max } T_{P1}$		17		A
I_{sc}	Short circuit current	$T_{P1} = 25^{\circ}\text{C}$, See Note 2		1.8		A
C_{out}	Recommended Capacitive Load	$T_{P1} = 25^{\circ}\text{C}$, See Note 3	270		1200	μF
V_{Oac}	Output ripple & noise	See ripple & noise section, V_{Oi}		50		mVp-p

Note 1: Sink current drawn by external device connected to the RC pin

Note 2: RMS current shorted output

 Note 3: Low ESR < 20 m Ω value, OS-CON

PKU4600A Series Fully Regulated DC-DC Converters Input 36-60 V, Output up to 12 A / 60 W

28701-BMR67601 Rev.C

March 2020

© Flex

Typical Characteristics: 5 V, 12 A / 60 W

PKU4611A

Efficiency

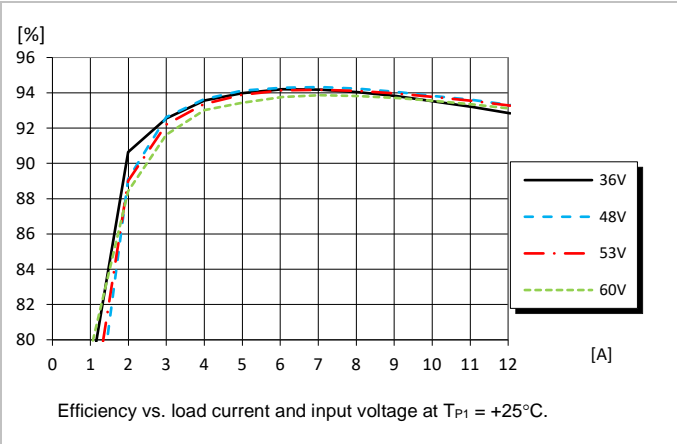

Power Dissipation

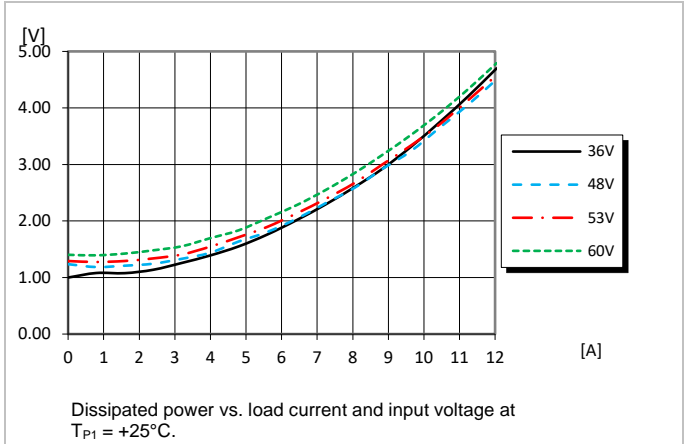

Output Characteristics

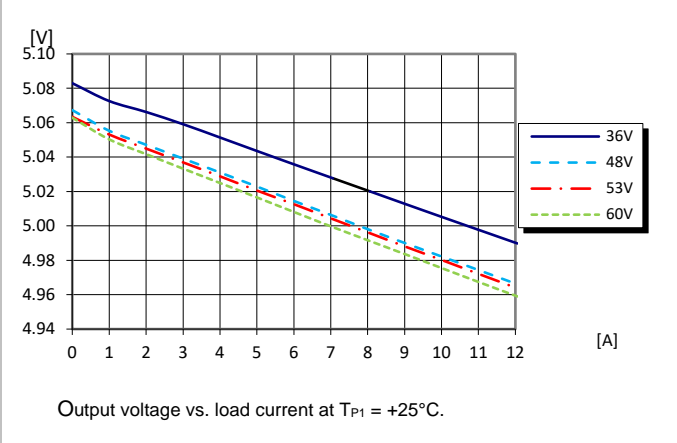

Output Characteristics

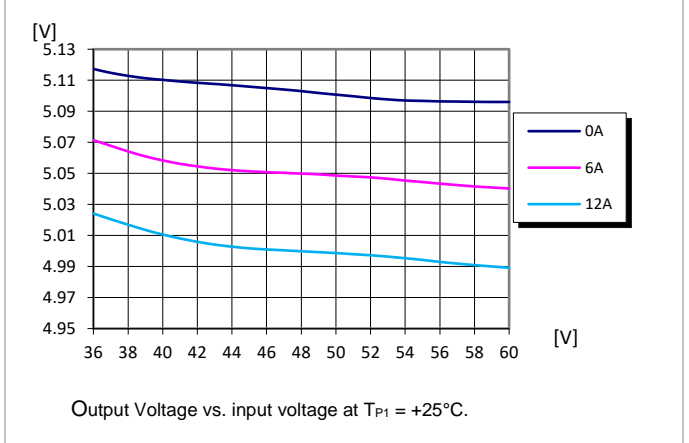

Current Limit Characteristics

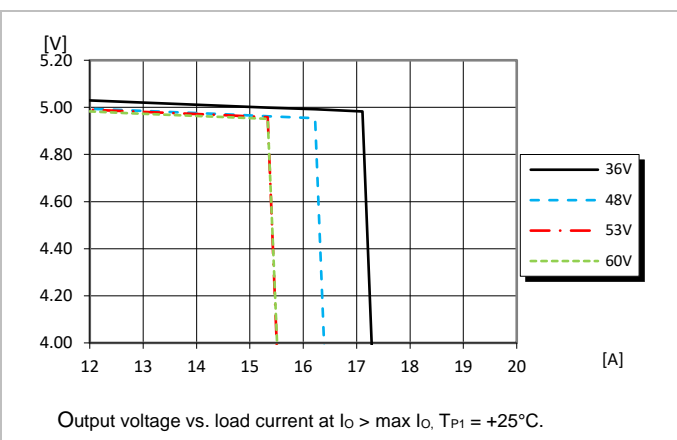

Output Characteristics $V_{adj} = 6\text{V}$

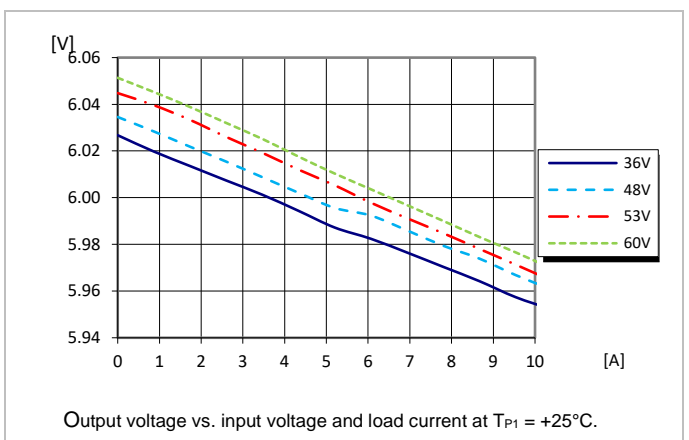

PKU4600A Series Fully Regulated DC-DC Converters
 Input 36-60 V, Output up to 12 A / 60 W

28701-BMR67601 Rev.C

March 2020

© Flex

Typical Characteristics
5 V, 12 A / 60 W

PKU4611A

Start-up

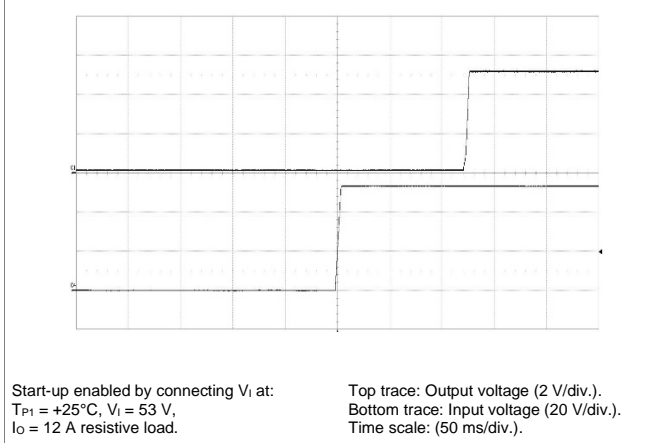

Shut-down

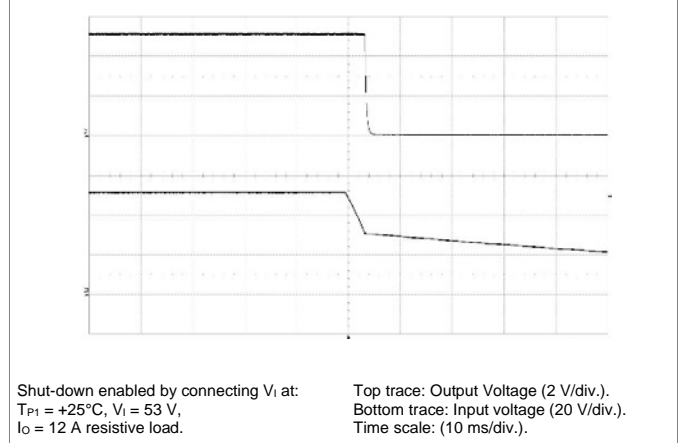

Output Ripple & Noise

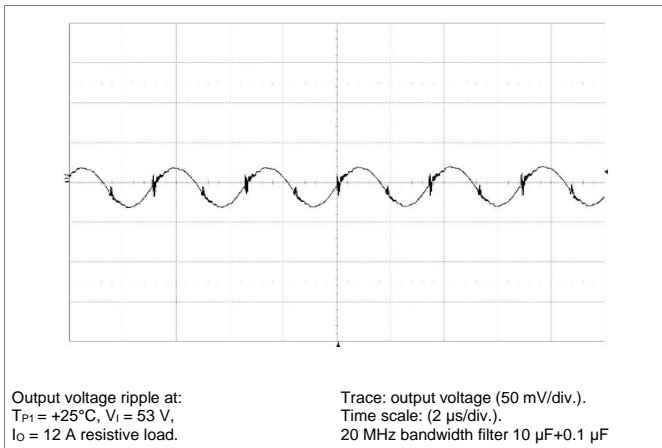

Output Load Transient Response

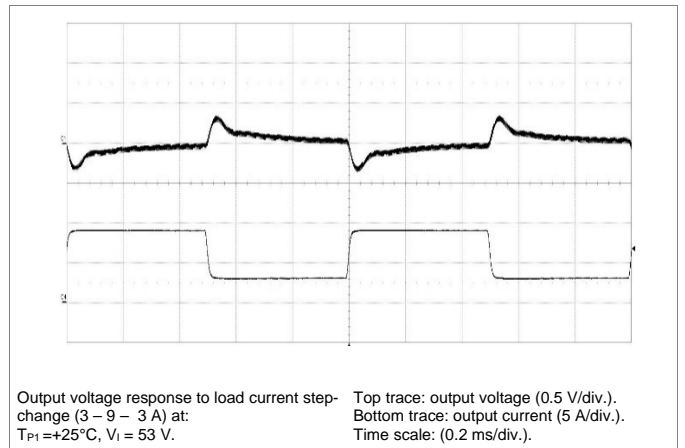

Output Current Derating – Open frame

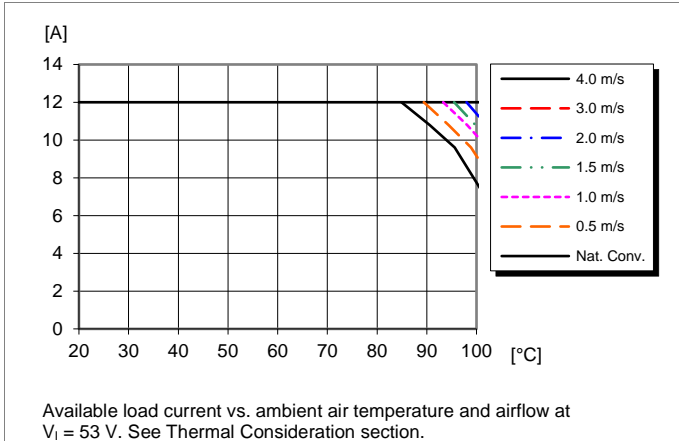

Output Current Derating – Cold wall sealed box

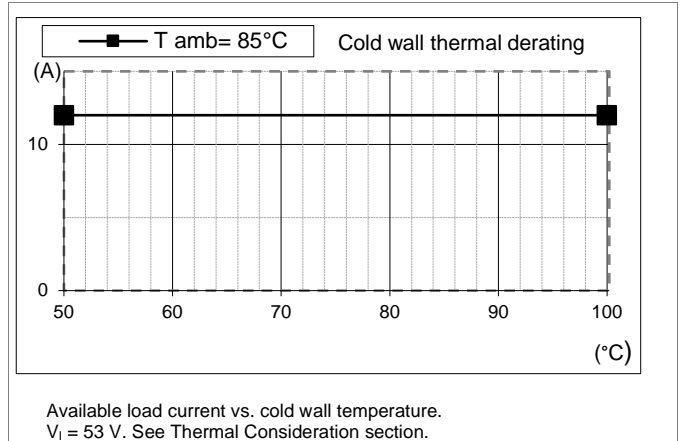

PKU4600A Series Fully Regulated DC-DC Converters
Input 36-60 V, Output up to 12 A / 60 W

28701-BMR67601 Rev.C

March 2020

© Flex

Thermal Resistance

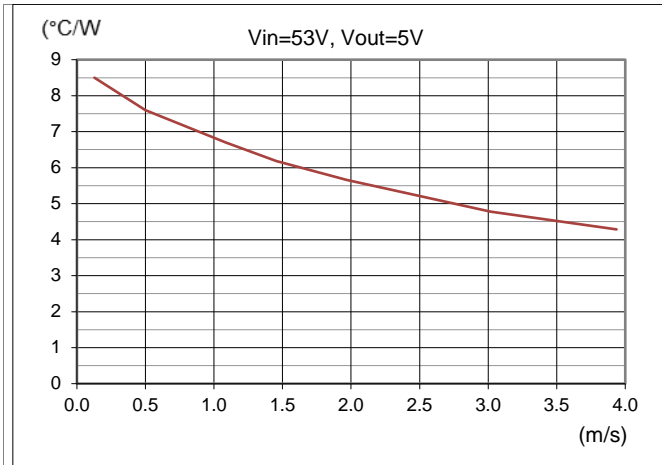

Thermal resistance vs. airspeed measured at the converter. Tested in wind tunnel with airflow and test conditions as per the Thermal consideration section. $V_i = 53$ V.

PKU4600A Series Fully Regulated DC-DC Converters
 Input 36-60 V, Output up to 12 A / 60 W

28701-BMR67601 Rev.C

March 2020

© Flex

Electrical Specification
6 V, 10 A / 60 W
PKU4617VA
 $T_{P1} = -40$ to $+95^{\circ}\text{C}$, $V_I = 36$ to 60 V, $V_{out} = 6$ V for all table conditions and setting unless otherwise specified under Conditions.

 Typical values given at: $T_{P1} = +25^{\circ}\text{C}$, $V_I = 53$ V max I_O , unless otherwise specified under Conditions.

 Additional $C_{in} = 100$ μF Nichicon, $C_{out} = 270$ μF OS-CON.

Characteristics		Conditions	min	typ	max	Unit
V_I	Input voltage range		36		60	V
V_{loff}	Turn-off input voltage	Decreasing input voltage	31	32	33	V
V_{lon}	Turn-on input voltage	Increasing input voltage	33	34	35	V
C_I	Internal input capacitance	$V_I = 53$ V		3		μF
P_O	Output power Average		0		60	W
η	Efficiency	50% of max I_O		94		%
		max I_O		93.5		
P_d	Power Dissipation	max I_O		4.7		W
P_{ii}	Input idling power	$I_O = 0$ A, $V_I = 53$ V		1.4		W
P_{RC}	Input standby power	$V_I = 53$ V (turned off with RC)		0.15		W
f_s	Switching frequency	0-100 % of max I_O	280	300	320	kHz

V_{oi}	Nominally Output voltage initial setting and accuracy	$T_{P1} = +25^{\circ}\text{C}$, $V_I = 53$ V, $I_O = 5$ A		5.92		V
V_o	Output voltage tolerance band	0-100% of max I_O , $V_I = 36$ -60 V	5.83		6.02	V
	Output adjust range	Max $I_O = 10$ A, $P_O = 60$ W, Resistor added V_{adj} -pin to GND-pin for $V_{out} = 6.5$ V \sim 38 k Ω , $= 7$ V \sim 16 k Ω	6.0		7.0	V
	Idling voltage	$I_O = 0$ A, $V_I = 36$ -60 V		6.02		V
	Line regulation	$V_I = 36$ -60 V, max I_O	-30		+30	mV
	Load regulation	$V_I = 53$ V, 10-100% of max I_O	-130		+130	mV
V_{tr}	Load transient voltage deviation	$V_I = 53$ V, Load step 25-75-25% of max I_O , $di/dt = 0.5$ A/ μs , $C_O = 270$ μF		± 350		mV
t_{tr}	Load transient recovery time			100		μs
t_r	Ramp-up time (from 10-90% of V_{oi})	10-100% of max I_O		10		ms
t_s	Start-up time (from V_I connection to 90% of V_{oi})			120		ms
t_{RC}	RC start-up time (from V_{RC} connection to 90% of V_{oi})	max I_O		10		ms
RC	Sink current, See Note 1	See operating information		0.16		mA
	Trigger level	Enable Threshold		1.22		V
I_O	Output current		0		10	A
I_{lim}	Current limit threshold	$T_{P1} < \text{max } T_{P1}$		18		A
I_{sc}	Short circuit current	$T_{P1} = 25^{\circ}\text{C}$, See Note 2		1.8		A
C_{out}	Recommended Capacitive Load	$T_{P1} = 25^{\circ}\text{C}$, See Note 3	270		1000	μF
V_{Oac}	Output ripple & noise	See ripple & noise section, V_{oi}		60		mVp-p

Note 1: Sink current drawn by external device connected to the RC pin

Note 2: RMS current shorted output

 Note 3: Low ESR < 20m Ω value, OS-CON

PKU4600A Series Fully Regulated DC-DC Converters
 Input 36-60 V, Output up to 12 A / 60 W

28701-BMR67601 Rev.C

March 2020

© Flex

Typical Characteristics:
6 V, 10 A / 60 W

PKU4617VA

Efficiency

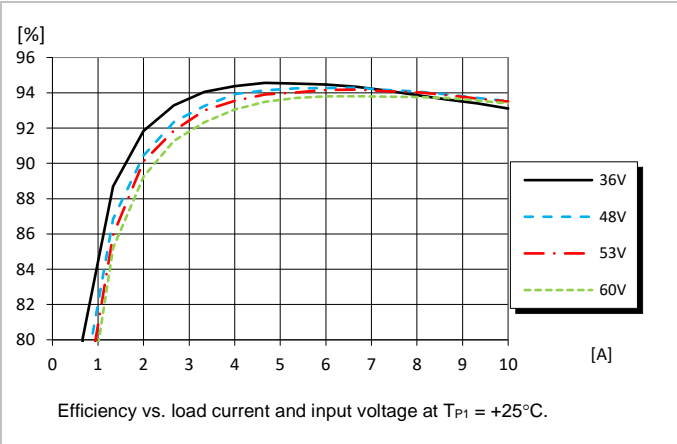

Power Dissipation

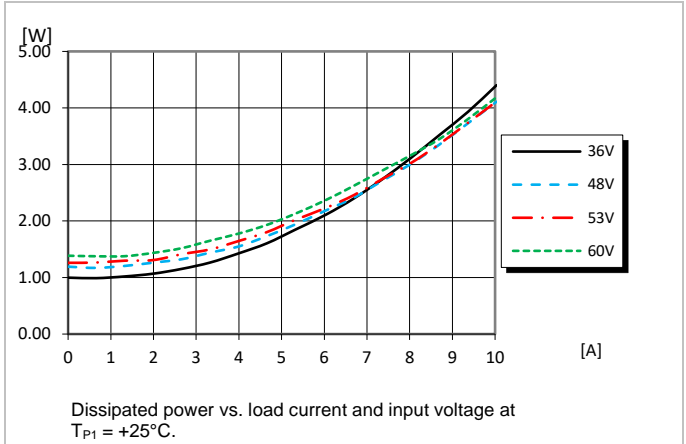

Output Characteristics

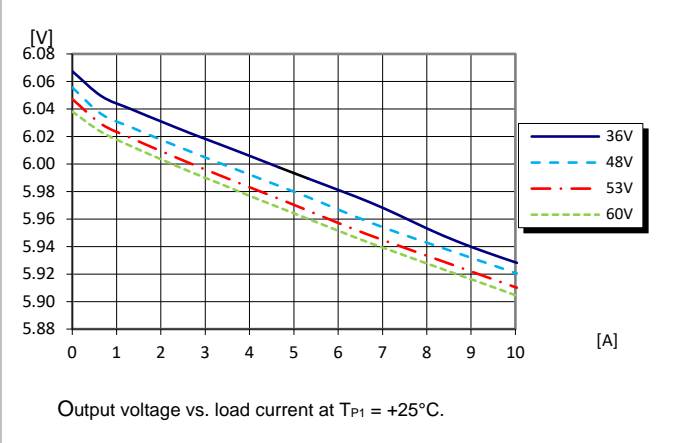

Output Characteristics

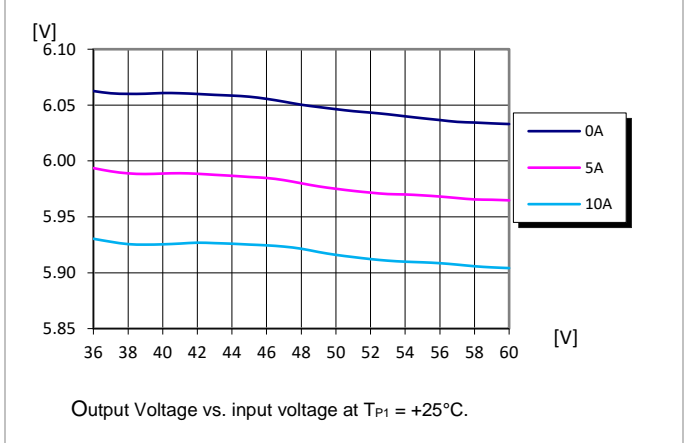

Current Limit Characteristics

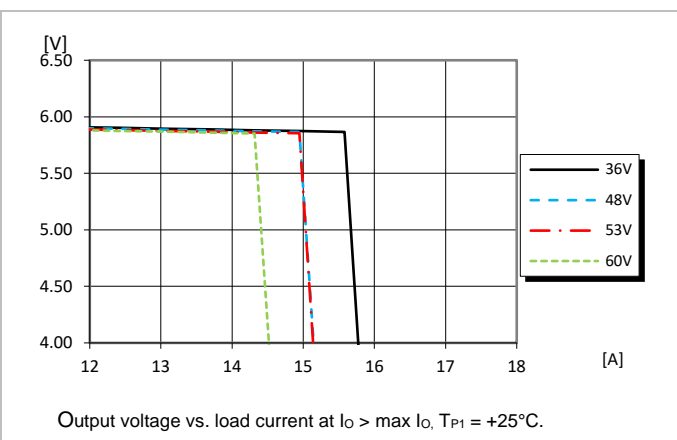

Output Characteristics $V_{adj} = 7V$

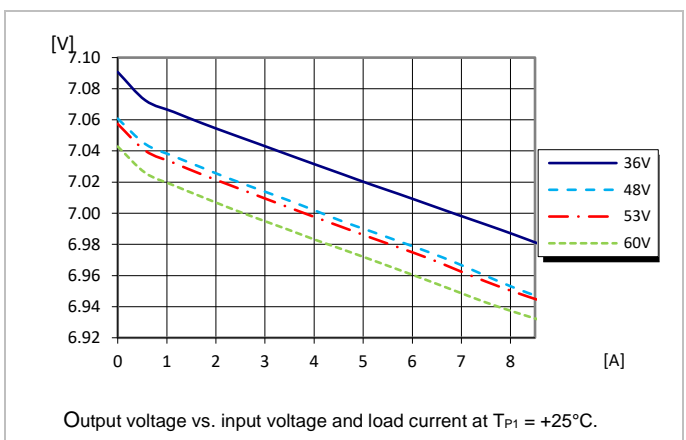

PKU4600A Series Fully Regulated DC-DC Converters
 Input 36-60 V, Output up to 12 A / 60 W

28701-BMR67601 Rev.C

March 2020

© Flex

Typical Characteristics
 6 V, 10 A / 60 W

PKU4617VA

Start-up

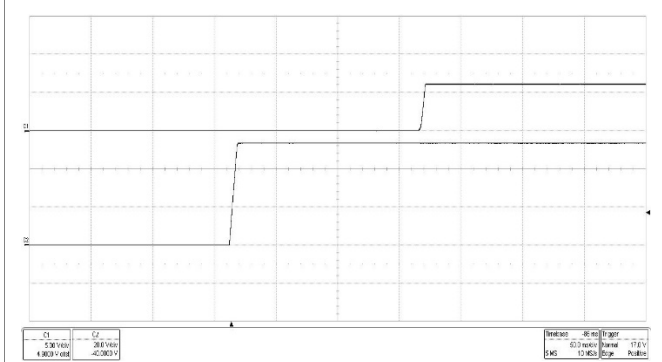

Start-up enabled by connecting V_I at:
 $T_{P1} = +25^\circ\text{C}$, $V_I = 53\text{ V}$,
 $I_O = 10\text{ A}$ resistive load.

Top trace: Output voltage (5 V/div.).
 Bottom trace: Input voltage (20 V/div.).
 Time scale: (50 ms/div.).

Shut-down

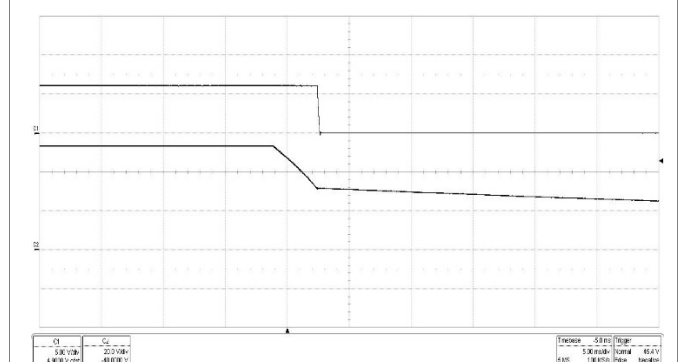

Shut-down enabled by connecting V_I at:
 $T_{P1} = +25^\circ\text{C}$, $V_I = 53\text{ V}$,
 $I_O = 10\text{ A}$ resistive load.

Top trace: Output Voltage (5 V/div.).
 Bottom trace: Input voltage (20 V/div.).
 Time scale: (5 ms/div.).

Output Ripple & Noise

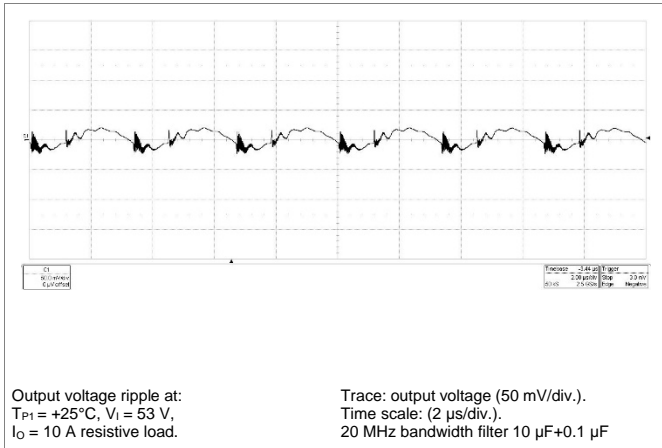

Output voltage ripple at:
 $T_{P1} = +25^\circ\text{C}$, $V_I = 53\text{ V}$,
 $I_O = 10\text{ A}$ resistive load.

Trace: output voltage (50 mV/div.).
 Time scale: (2 μs/div.).
 20 MHz bandwidth filter 10 μF+0.1 μF

Output Load Transient Response

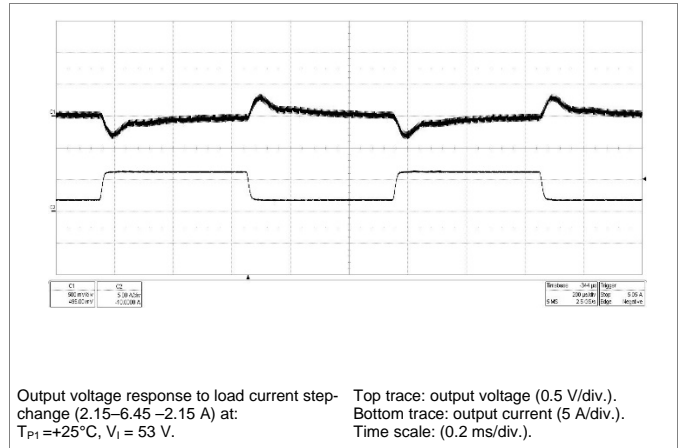

Output voltage response to load current step-change (2.15–6.45–2.15 A) at:
 $T_{P1} = +25^\circ\text{C}$, $V_I = 53\text{ V}$.

Top trace: output voltage (0.5 V/div.).
 Bottom trace: output current (5 A/div.).
 Time scale: (0.2 ms/div.).

Output Current Derating – Open frame

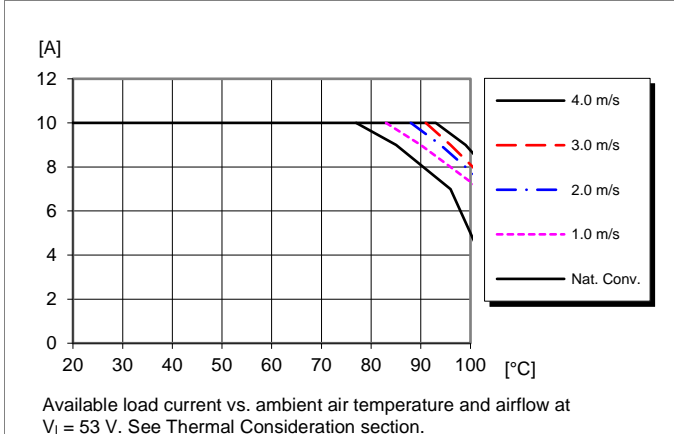

Available load current vs. ambient air temperature and airflow at $V_I = 53\text{ V}$. See Thermal Consideration section.

Output Current Derating – Cold wall sealed box

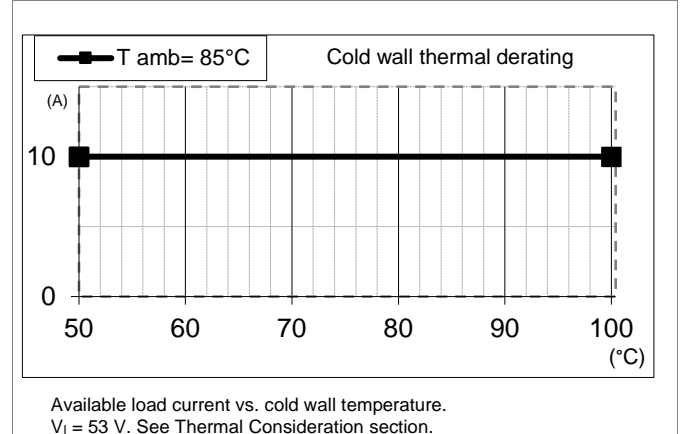

Available load current vs. cold wall temperature. $V_I = 53\text{ V}$. See Thermal Consideration section.

PKU4600A Series Fully Regulated DC-DC Converters
Input 36-60 V, Output up to 12 A / 60 W

28701-BMR67601 Rev.C

March 2020

© Flex

Thermal Resistance

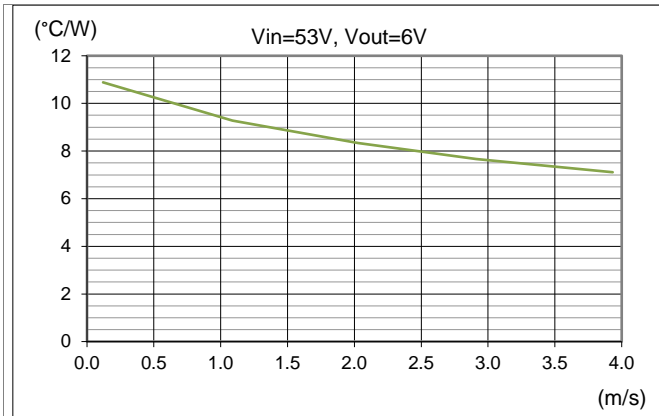

Thermal resistance vs. airspeed measured at the converter. Tested in wind tunnel with airflow and test conditions as per the Thermal consideration section. $V_i = 53$ V.

PKU4600A Series Fully Regulated DC-DC Converters Input 36-60 V, Output up to 12 A / 60 W

28701-BMR67601 Rev.C

March 2020

© Flex

EMC Specification

Conducted EMI measured according to EN 55022/EN 55032, CISPR 22/CISPR 32 and FCC part 15J (see test set-up). See Design Note 029 for further information. The fundamental switching frequency is 300 kHz for PKU-A. The EMI characteristics below is measured at $V_I = 53$ V and max I_o . (EMI measurement result similar for PKUA4611A and PKUA4617VA).

Conducted EMI Input terminal value (typ)

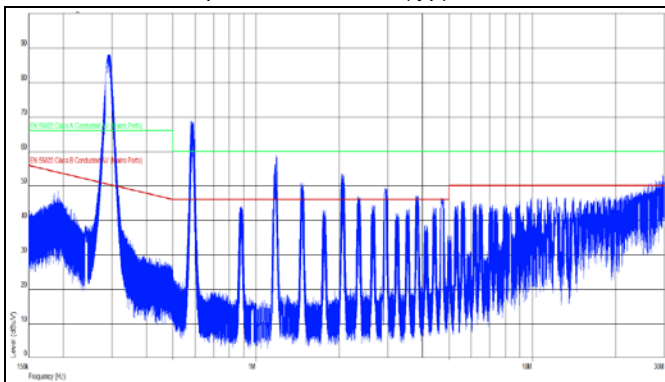

EMI without filter, EN55032 Test method and limits are the same as EN55022

Optional external filter for class B

Suggested external input filter in order to meet class B in EN 55032, CISPR 32 and FCC part 15J.

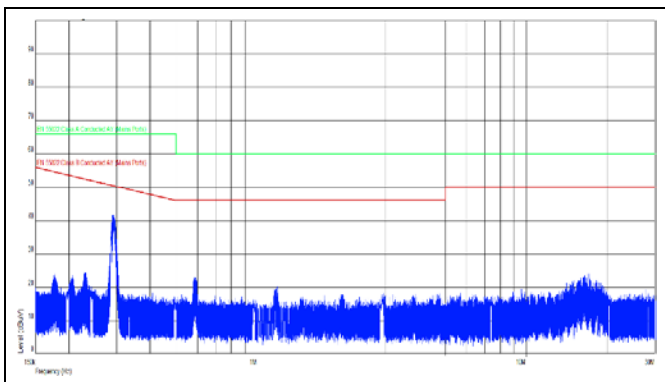
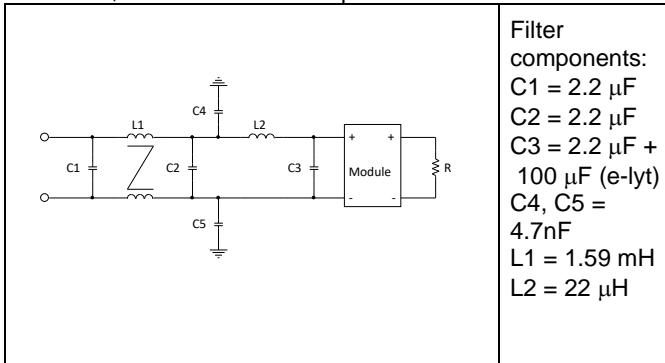

EMI with filter, EN55032 Test method and limits are the same as EN55022

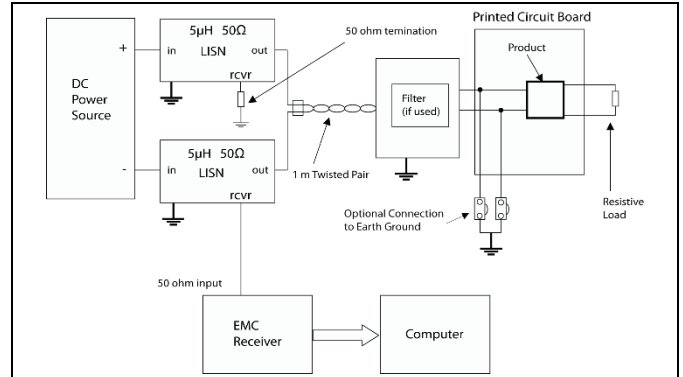

Test set-up

Layout recommendations

The radiated EMI performance of the product will depend on the PWB layout and ground layer design. It is also important to consider the stand-off of the product. If a ground layer is used, it should be connected to the output of the product and to the equipment ground or chassis.

A ground layer will increase the stray capacitance in the PWB and improve the high frequency EMC performance.

Output ripple and noise

Output ripple and noise is measured according to figure below. See Design Note 022 for detailed information.

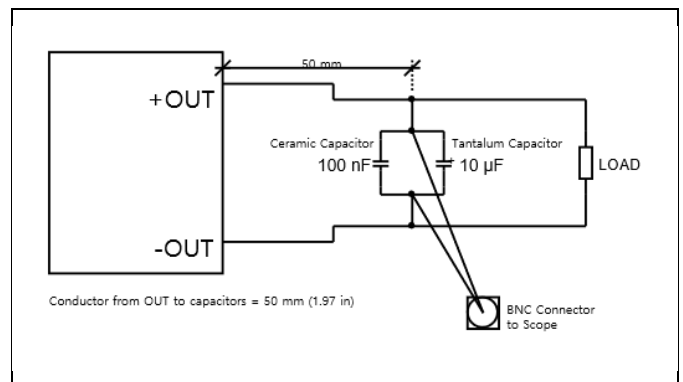

Output ripple and noise test setup

PKU4600A Series Fully Regulated DC-DC Converters

Input 36-60 V, Output up to 12 A / 60 W

28701-BMR67601 Rev.C

March 2020

© Flex

Operating information

Input Voltage

The input voltage range 36 to 60 Vdc meets the customer specification.

Short duration transient disturbances can occur on the DC distribution and input of the product when a short circuit fault occurs on the equipment side of a protective device (fuse or circuit breaker). The voltage level, duration and energy of the disturbance are dependent on the particular DC distribution network characteristics and can be sufficient to damage the product unless measures are taken to suppress or absorb this energy. The transient voltage can be limited by capacitors and other energy absorbing devices like Zener diodes connected across the positive and negative input conductors at a number of strategic points in the distribution network. The end-user must secure that the transient voltage will not exceed the value stated in the Absolute maximum ratings. ETSI TR 100 283 examines the parameters of DC distribution networks and provides guidelines for controlling the transient and reduce its harmful effect.

Turn-off Input Voltage

The products monitor the input voltage and will turn on and turn off at predetermined levels. The minimum hysteresis between turn on and turn off input voltage is ~ 2.0 V.

Remote Control (RC)

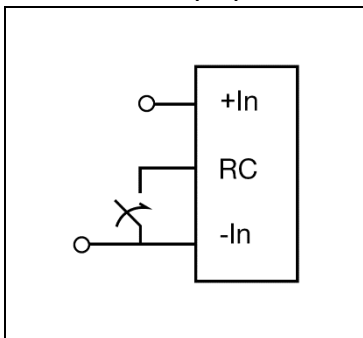

The products are fitted with a remote control function referenced to the primary negative input connection (-In), with negative and positive logic options available. The RC function allows the product to be turned on/off by an external device like a semiconductor or mechanical switch.

Input and Output Impedance

The impedance of both the input source and the load will interact with the impedance of the product. It is important that the input source has low characteristic impedance. The products are designed for stable operation with a minimum of 100 μ F external capacitors connected to the input. The electrolytic capacitors will be degraded in low temperature and the ESR value may increase. The needed input capacitance in low temperature should be equivalent to 100 μ F at 20° C. This means that the input capacitor value may need to be substantially larger to guarantee a stable input at low temperatures. The performance in some applications can be enhanced by addition of external capacitance as described under External Decoupling Capacitors. The minimum required capacitance value depends on the output power and the input voltage. The higher output power the higher input capacitance is needed.

External Decoupling Capacitors

When powering loads with significant dynamic current requirements, the voltage regulation at the load can be improved by addition of decoupling capacitors at the load. The most effective technique is to locate low ESR ceramic and electrolytic capacitors as close to the load as possible, using several parallel capacitors to lower the effective ESR. The ceramic capacitors will handle high-frequency dynamic load changes while the electrolytic capacitors are used to handle low frequency dynamic load changes. It is equally important to use low resistance and low inductance PWB layouts and cabling.

External decoupling capacitors will become part of the product's control loop. The control loop is optimized for a wide range of external capacitance and the maximum and minimum recommended value that could be used without any additional analysis is found in the Electrical specification. The ESR of the capacitors is a very important parameter. Stable operation is guaranteed with a verified ESR value of >1 m Ω across the output connections.

For further information please contact your local Flex Power Modules representative.

Output Voltage Adjust (V_{adj})

The products have an Output Voltage Adjust pin (V_{adj}). This pin can be used to adjust the output voltage above Output voltage initial setting. To increase the output voltage, resistor should be connected between the V_{adj} pin and -In pin.

PKU4600A Series Fully Regulated DC-DC Converters
Input 36-60 V, Output up to 12 A / 60 W

28701-BMR67601 Rev.C

March 2020

© Flex

Parallel Operation

This product is not designed for paralleling. Recommended to add a Y-capacitor +In to +Out if common power supply.

Over Temperature Protection (OTP)

The products are protected from thermal overload by an internal over temperature shutdown circuit. When control circuit as defined in thermal consideration section exceeds critical temperature, the product will shut down. The product will make continuous attempts to start up (non-latching mode) and resume normal operation automatically when the temperature has dropped $>10^{\circ}\text{C}$ below the temperature threshold.

Over Voltage Protection (OVP)

This product is not designed with that function.

Over Current Protection (OCP)

The products include current limiting circuitry for protection at continuous overload. The OCP works in a hiccup mode and will make continuous attempts to start up and will resume normal operation automatically after removal of the over current condition. The load distribution should be designed for the specified maximum output short circuit current.

Thermal Consideration

General

For products mounted on a PWB without a baseplate attached, cooling is achieved mainly by conduction, from the pins to the host board, and convection, which is dependent on the airflow across the product. Increased airflow enhances the cooling of the product. The Output Current Derating graph found in the Output section for each model provides the available output current vs. ambient air temperature and air velocity at $V_1 = 53 \text{ V}$.

The product is tested on a 254 x 254 mm, 35 μm (1 oz), 16-layer test board mounted vertically in a wind tunnel with a cross-section of 608 x 203 mm.

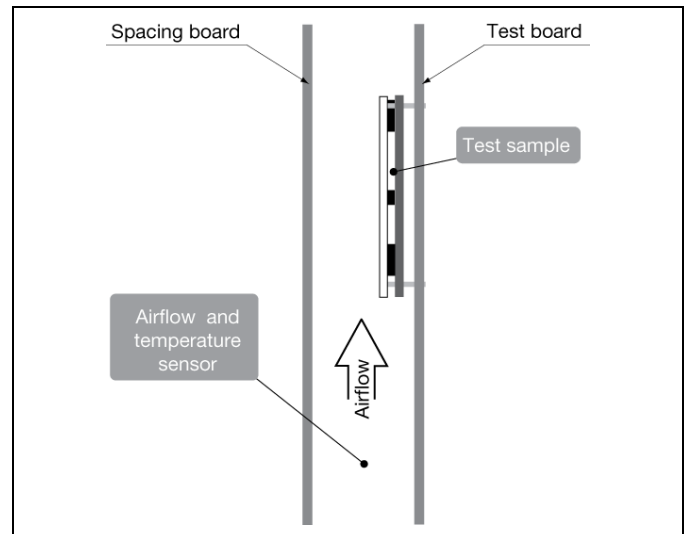

For products with Base-plate or with gap-pad in a sealed box/cold wall application, cooling is achieved mainly by conduction through the cold wall. The Output Current Derating graphs are found in the Output section for each model. The product performance has been tested in a sealed box presented in the figure below. The ambient temperature (inside the box) has been set to 85°C . The cold wall temperature varied. See Design Note 028 for further details.

PKU4600A Series Fully Regulated DC-DC Converters
 Input 36-60 V, Output up to 12 A / 60 W

28701-BMR67601 Rev.C March 2020
 © Flex

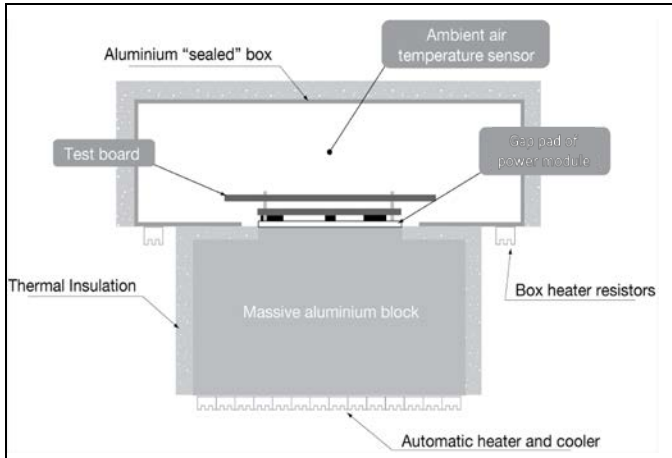

Ambient Temperature Calculation

The maximum allowed ambient temperature can be calculated by using the thermal resistance.

1. The power loss is calculated by using the formula $((1/\eta) - 1) \times \text{output power} = \text{power losses (Pd)}$.

η = efficiency of product. E.g. 94.5% = 0.945

2. Find the thermal resistance (Rth) in the Thermal Resistance graph found in the Output section for each model. **Note that the thermal resistance can be significantly reduced if a Gap Pad and heatsink is mounted on the top of the module.** (see below, Gap Pad picture)

Calculate the temperature increase (ΔT).

$$\Delta T = R_{th} \times P_d$$

3. Max allowed ambient temperature is:

$$\text{Max } T_{P1} - \Delta T.$$

E.g. PKU 4611A at 1m/s:

$$1. ((\frac{1}{0.93}) - 1) \times 60 \text{ W} = 4.5 \text{ W}$$

$$2. 4.5 \text{ W} \times 8.5^\circ\text{C/W} = 38.38^\circ\text{C}$$

$$3. 125^\circ\text{C} - 38.25^\circ\text{C} = \text{max ambient temperature is } 86.75^\circ\text{C}.$$

The actual temperature will be dependent on several factors such as the PWB size, number of layers and direction of airflow.

Definition of product operating temperature

The temperature at the positions (T_{P1} , T_{P2}) should not exceed the maximum temperatures in the table below. The number of measurement points may vary with different thermal design and topology. Temperatures above maximum measured at the reference point TP1, TP2 are not allowed and may cause permanent damage.

Position	Description	Max Temp.
TP1	Transformer PWB winding	$T_{P1}=125^\circ\text{C}$
TP2	MOSFET, Reference point	$T_{P2}=125^\circ\text{C}$

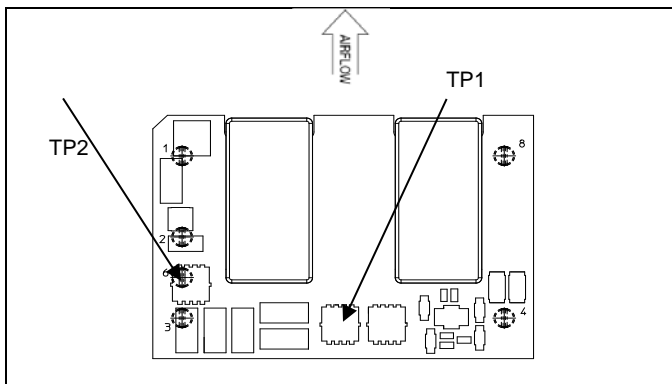

Open frame (top-side view)

Heat sink and Gap Pad

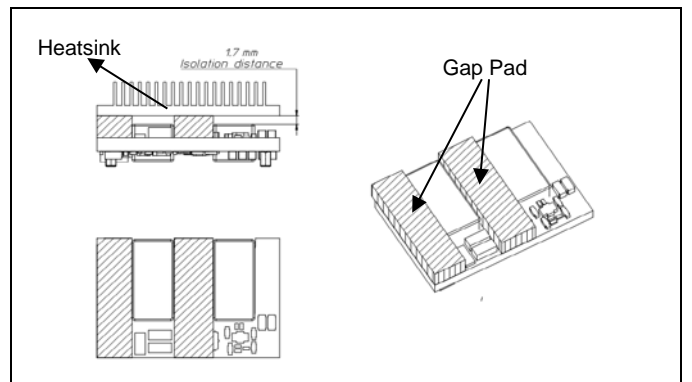

Gap Pad position on the top layer of the module

To guaranty isolation between primary and secondary part of the module the isolation distance between heatsink and ferrite on the top of module must be 1.7mm.
 Recommended Gap Pad Laird's Tflex™ HD90000, 7,5 W/mK.

PKU4600A Series Fully Regulated DC-DC Converters
Input 36-60 V, Output up to 12 A / 60 W

28701-BMR67601 Rev.C

March 2020

© Flex

Connections

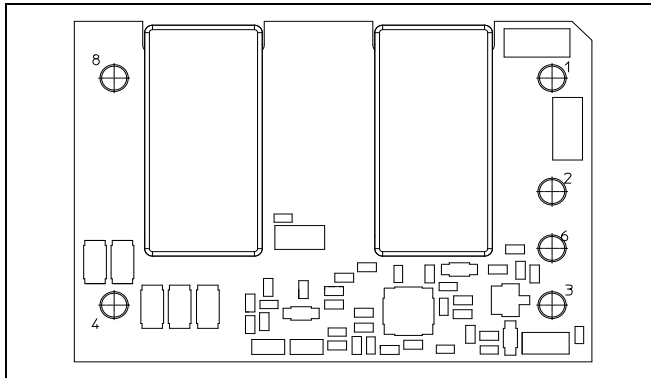

Open frame (bottom view)

Pin	Designation	Function
1	+In	Positive Input
2	RC	Remote Control
3	-In	Negative Input
4	-Out	Negative Output
6	Vadj	Output Voltage adjust
8	+Out	Positive Output

PKU4600A Series Fully Regulated DC-DC Converters
 Input 36-60 V, Output up to 12 A / 60 W

28701-BMR67601 Rev.C

March 2020

© Flex

Mechanical Information - SMD Mount, Open Frame Version

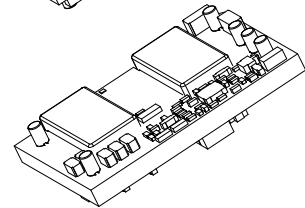
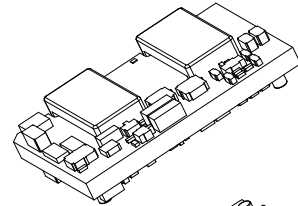
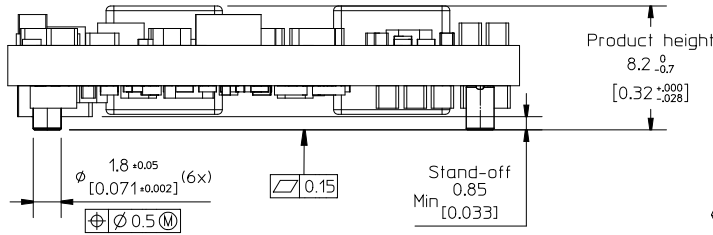

TOP VIEW

Pin positions according to recommended footprint

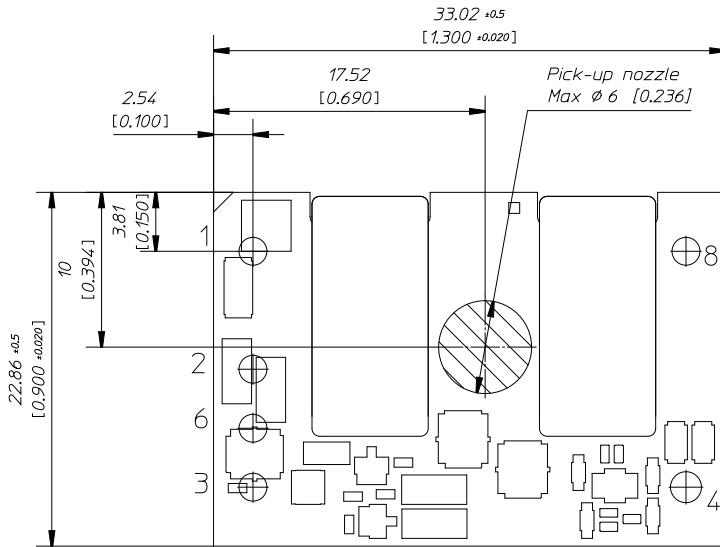

RECOMMENDED FOOTPRINT - TOP VIEW

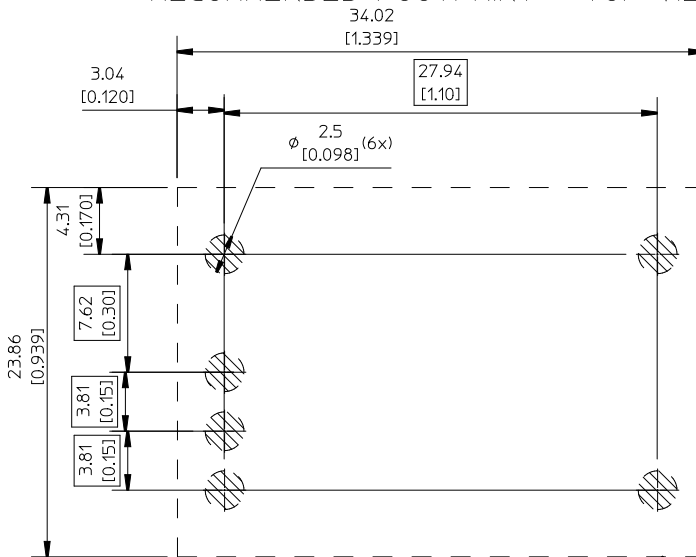

Recommended keep away area for user components

Pins
 Material Copper alloy
 Plating: 0.1µm Gold (Au) over 2µm Nickel (ni)

Layout considerations:
 Use sufficient numbers of vias connected to output pin pad for proper thermal and current conductivity

Recommended pad dimensions are only for reference. It is the end users decision based on different situations like production processes, substrate thickness etc.

Weight: typical 12.7 g
 All dimensions in mm [inch].
 Tolerances unless specified
 x.x mm ±0.50 mm [0.02]
 x.xx mm ±0.25 mm [0.01]
 (not applied on footprint or typical values)



All component placements – whether shown as physical components or symbolical outline – are for reference only and are subject to change throughout the product's life cycle, unless explicitly described and dimensioned in this drawing

PKU4600A Series Fully Regulated DC-DC Converters
Input 36-60 V, Output up to 12 A / 60 W

28701-BMR67601 Rev.C March 2020
© Flex

Soldering Information - Surface Mounting

The surface mount product is intended for forced convection or vapor phase reflow soldering in SnPb or Pb-free processes.

The reflow profile should be optimised to avoid excessive heating of the product. It is recommended to have a sufficiently extended preheat time to ensure an even temperature across the host PWB and it is also recommended to minimize the time in reflow.

A no-clean flux is recommended to avoid entrapment of cleaning fluids in cavities inside the product or between the product and the host board, since cleaning residues may affect long time reliability and isolation voltage.

General reflow process specifications		SnPb eutectic	Pb-free
Average ramp-up ($T_{PRODUCT}$)		3°C/s max	3°C/s max
Typical solder melting (liquidus) temperature	T_L	183°C	221°C
Minimum reflow time above T_L		30 s	30 s
Minimum pin temperature	T_{PIN}	210°C	235°C
Peak product temperature	$T_{PRODUCT}$	225°C	260°C
Average ramp-down ($T_{PRODUCT}$)		6°C/s max	6°C/s max
Maximum time 25°C to peak		6 minutes	8 minutes

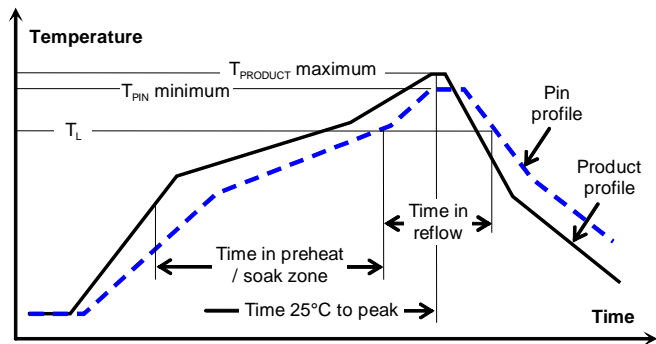

Minimum Pin Temperature Recommendations

Pin number 4 is chosen as reference location for the minimum pin temperature recommendation since it will likely be the coolest solder joint during the reflow process.

SnPb solder processes

For SnPb solder processes, a pin temperature (T_{PIN}) in excess of the solder melting temperature, (T_L , 183°C for Sn63Pb37) for more than 30 seconds and a peak temperature of 210°C is recommended to ensure a reliable solder joint.

For dry packed products only: depending on the type of solder paste and flux system used on the host board, up to a recommended maximum temperature of 245°C could be used, if the products are kept in a controlled environment (dry pack handling and storage) prior to assembly.

Lead-free (Pb-free) solder processes

For Pb-free solder processes, a pin temperature (T_{PIN}) in excess of the solder melting temperature (T_L , 217 to 221°C for SnAgCu solder alloys) for more than 30 seconds and a peak temperature of 235°C on all solder joints is recommended to ensure a reliable solder joint.

Maximum Product Temperature Requirements

Top of the product PWB near pin 2 is chosen as reference location for the maximum (peak) allowed product temperature ($T_{PRODUCT}$) since this will likely be the warmest part of the product during the reflow process.

SnPb solder processes

For SnPb solder processes, the product is qualified for MSL 1 according to IPC/JEDEC standard J-STD-020C.

During reflow $T_{PRODUCT}$ must not exceed 225 °C at any time.

Pb-free solder processes

For Pb-free solder processes, the product is qualified for MSL 3 according to IPC/JEDEC standard J-STD-020C.

During reflow $T_{PRODUCT}$ must not exceed 260 °C at any time.

Dry Pack Information

Products intended for Pb-free reflow soldering processes are delivered in standard moisture barrier bags according to IPC/JEDEC standard J-STD-033 (Handling, packing, shipping and use of moisture/reflow sensitivity surface mount devices).

Using products in high temperature Pb-free soldering processes requires dry pack storage and handling. In case the products have been stored in an uncontrolled environment and no longer can be considered dry, the modules must be baked according to J-STD-033.

Thermocoupler Attachment

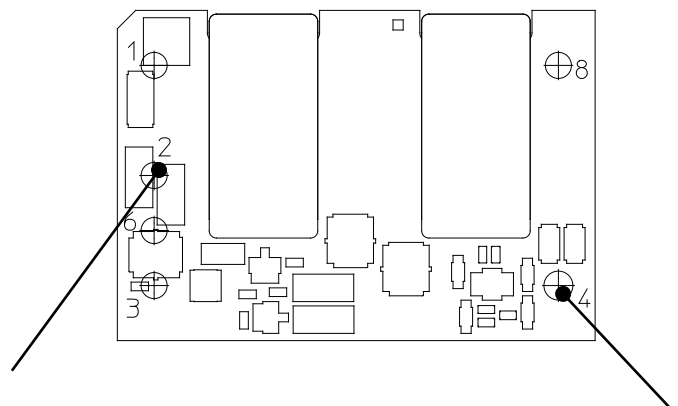

Top of PWB near pin 2 for measurement of maximum product temperature, $T_{PRODUCT}$

Pin 4 for measurement of minimum pin (solder joint) temperature, T_{PIN}

PKU4600A Series Fully Regulated DC-DC Converters Input 36-60 V, Output up to 12 A / 60 W	28701-BMR67601 Rev.C	March 2020
	© Flex	

Soldering Information - Hole Mounting

The hole mounted product is intended for plated through hole mounting by wave or manual soldering. The pin temperature is specified to maximum to 270°C for maximum 10 seconds.

A maximum preheat rate of 4°C/s and maximum preheat temperature of 150°C is suggested. When soldering by hand, care should be taken to avoid direct contact between the hot soldering iron tip and the pins for more than a few seconds in order to prevent overheating.

A no-clean flux is recommended to avoid entrapment of cleaning fluids in cavities inside the product or between the product and the host board. The cleaning residues may affect long time reliability and isolation voltage.

PKU4600A Series Fully Regulated DC-DC Converters Input 36-60 V, Output up to 12 A / 60 W

28701-BMR67601 Rev.C

March 2020

© Flex

Delivery Package Information,

The surface mount products are delivered in an antistatic carrier tape (Jedec design EIA 481 standard).

Carrier Tape Specifications	SMD Version	
Material	Antistatic PS	
Surface resistance	$10^7 < \text{Ohm/square}$	
Bakeability	The tape is not bakeable	
Tape width, W	56 mm [2.2 inch]	
Pocket pitch, P₁	36 mm [1.42 inch]	
Pocket depth, K₀	9.3 mm [0.366 inch]	
Reel diameter	380 mm [15 inch]	
Reel capacity	200 products /reel	
Reel weight	2.5 kg/full reel	

Side view



User tape feed direction →

Pocket depth.

Top view

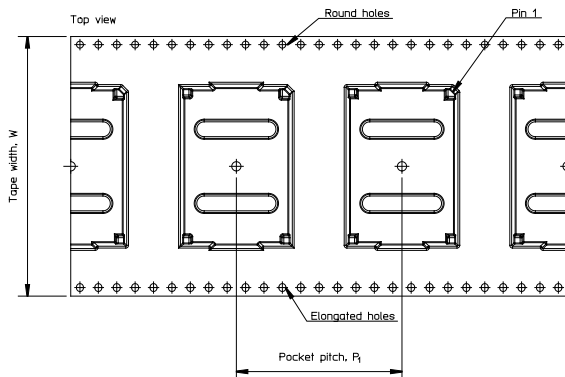

PKU4600A Series Fully Regulated DC-DC Converters
 Input 36-60 V, Output up to 12 A / 60 W

28701-BMR67601 Rev.C

March 2020

© Flex

Product Qualification Specification



Characteristics			
External visual inspection	IPC-A-610		
Change of temperature (Temperature cycling)	IEC 60068-2-14 Na	Temperature range Number of cycles Dwell/transfer time	-40 to 100°C 500 15 min/0-1 min
Cold (in operation)	IEC 60068-2-1 Ad	Temperature T _A Duration	-45°C 72 h
Damp heat	IEC 60068-2-67 Cy	Temperature Humidity Duration	85°C 85 % RH 1000 hours
Dry heat	IEC 60068-2-2 Bd	Temperature Duration	125°C 1000 h
Electrostatic discharge susceptibility	IEC 61340-3-1, JESD 22-A114 IEC 61340-3-2, JESD 22-A115	Human body model (HBM) Machine Model (MM)	Class 2, 2000 V Class 3, 200 V
Immersion in cleaning solvents	IEC 60068-2-45 XA, method 2	Water Glycol ether Isopropyl alcohol	55°C 35°C 35°C
Mechanical shock	IEC 60068-2-27 Ea	Peak acceleration Duration	100 g 6 ms
Moisture reflow sensitivity ¹	J-STD-020C	Level 1 (SnPb-eutectic) Level 3 (Pb Free)	225°C 260°C
Operational life test	MIL-STD-202G, method 108A	Duration	1000 h
Resistance to soldering heat ²	IEC 60068-2-20 Tb, method 1A	Solder temperature Duration	270°C 10-13 s
Robustness of terminations	IEC 60068-2-21 Test Ua1 IEC 60068-2-21 Test Ue1	Through hole mount products Surface mount products	All leads All leads
Solderability	IEC 60068-2-58 test Td ¹	Preconditioning Temperature, SnPb Eutectic Temperature, Pb-free	150°C dry bake 16 h 215°C 235°C
	IEC 60068-2-20 test Ta ²	Preconditioning Temperature, SnPb Eutectic Temperature, Pb-free	Steam ageing 235°C 245°C
Vibration, broad band random	IEC 60068-2-64 Fh, method 1	Frequency Spectral density Duration	10 to 500 Hz 0.07 g ² /Hz 10 min in each direction

Notes







¹ Only for products intended for reflow soldering (surface mount products)² Only for products intended for wave soldering (plated through hole products)

Looking for pricing, stock, or lifecycle information?

Click below to explore more details on WIN SOURCE:

-  [View PKU4611ASI on WIN SOURCE](#)
-  [Flex Power Modules Information](#)

Optimize Your Supply Chain with WIN SOURCE Solutions

-  Global Sourcing Solution
-  Obsolete Management
-  Cost Control Management
-  Shortage Management
-  Alternative Solution
-  Excess Inventory Management