



**THE DATASHEET OF
LQH32DN220K53L**



CHIP COIL (CHIP INDUCTORS) LQH32DN□□□□53L REFERENCE SPECIFICATION

1.Scope

This reference specification applies to LQH32DN_53 Series, Chip coil (Chip Inductors).

2.Part Numbering

(ex)	LQ	H	32	D	N	1R0	M	5	3	L
	Product ID	Structure	Dimension (L×W)	Applications and Characteristics	Category (For Automotive)	Inductance	Tolerance	Features	Electrode	Packaging L:Taping

3.Rating

- Operating Temperature Range. -40 to +105°C
- Storage Temperature Range. -40 to +105°C

Customer Part Number	MURATA Part Number	Inductance		DC Resistance (Ω)	Self Resonant Frequency (MHz min)	*Rated Current (mA)
		(μH)	Tolerance			
	LQH32DN1R0M53L	1.0	M:±20%	0.060±30%	100	1000
	LQH32DN2R2M53L	2.2		0.097±30%	64	790
	LQH32DN3R3M53L	3.3		0.12±30%	50	710
	LQH32DN4R7M53L	4.7		0.15±30%	43	650
	LQH32DN6R8M53L	6.8		0.25±30%	32	540
	LQH32DN100K53L	10	K:±10%	0.30±30%	26	450
	LQH32DN150K53L	15		0.58±30%	26	300
	LQH32DN220K53L	22		0.71±30%	19	250
	LQH32DN330K53L	33		1.1±30%	17	200
	LQH32DN470K53L	47		1.3±30%	15	170
	LQH32DN680K53L	68		2.2±30%	12	130
	LQH32DN101K53L	100		3.5±30%	10	100

*When applied Rated current to the Products , self temperature rise shall be limited to 20°C max and Inductance will be within ±10% of initial Inductance value.

4.Testing Conditions

<Unless otherwise specified>

- Temperature : Ordinary Temperature (15 to 35°C)
- Humidity : Ordinary Humidity (25 to 85 %(RH))

<In case of doubt>

- Temperature : 20 ± 2°C
- Humidity : 60 to 70 %(RH)
- Atmospheric Pressure : 86 to 106 kPa

5.Appearance and Dimensions

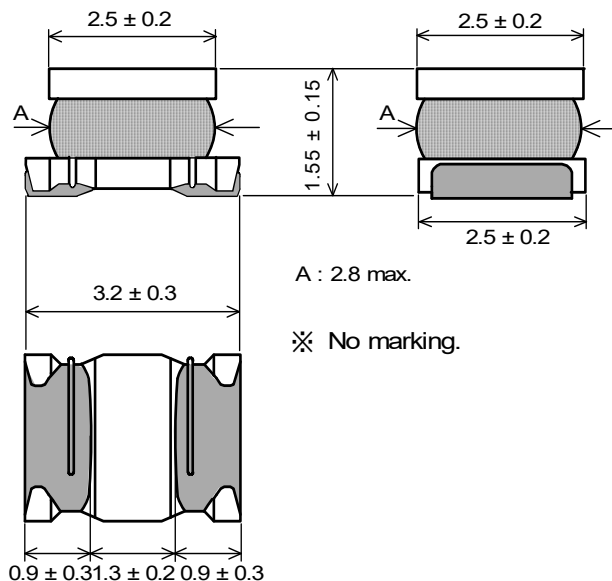

A : 2.8 max.

※ No marking.

■ Unit Mass (Typical value)
0.045 g

(in mm)

6.Electrical Performance

No.	Item	Specification	Test Method
6.1	Inductance	Inductance shall meet item 3.	Measuring Equipment : KEYSIGHT 4192A or equivalent Measuring Frequency: 1MHz
6.2	DC Resistance	DC Resistance shall meet item 3.	Measuring Equipment:Digital multi meter
6.3	Self Resonant Frequency(S.R.F)	S.R.F shall meet item 3.	Measuring Equipment : KEYSIGHT E4991A or equivalent

7.Mechanical Performance

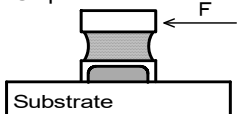
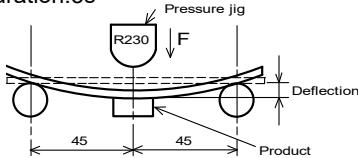
No.	Item	Specification	Test Method
7.1	Shear Test	Chip coil shall not be damaged.	Substrate:Glass-epoxy substrate Applied Direction : Chip coil  Force:10N Hold Duration:5±1s
7.2	Bending Test		Substrate:Glass-epoxy substrate (100×40×1.6mm) Speed of Applying Force:1mm / s Deflection:2mm Hold Duration:5s  (in mm)
7.3	Vibration		Oscillation Frequency : 10Hz~55Hz~10Hz for 1 minute Total amplitude 1.5 mm Testing Time:A period of 2 hours in each of 3 mutually perpendicular directions. (Total 6 hours)
7.4	Solderability	The wetting area of the electrode shall be at least 90% covered with new solder coating.	Flux:Ethanol solution of rosin,25(wt)% (Immersed for 5s to 10s) Solder : Sn-3.0Ag-0.5Cu Pre-Heating: 150±10°C / 60 to 90seconds Solder Temperature:240±5°C Immersion Time: 3±1 s

8.Environmental Performance (It shall be soldered on the substrate)

No.	Item	Specification	Test Method
8.1	Heat Resistance	Appearance:No damage Inductance Change: within $\pm 5\%$ DC Resistance Change: within $\pm 5\%$	Temperature:105 $\pm 2^{\circ}\text{C}$ Time: 1000h (+48h , -0h) Then measured after exposure in the room condition for 24 ± 2 hours.
8.2	Cold Resistance		Temperature:-40 $\pm 2^{\circ}\text{C}$ Time: 1000h (+48h , -0h) Then measured after exposure in the room condition for 24 ± 2 hours.
8.3	Humidity		Temperature:85 $\pm 2^{\circ}\text{C}$ Humidity:80~85%(RH) Time: 1000h (+48h , -0h) Then measured after exposure in the room condition for 24 ± 2 hours.
8.4	Temperature Cycle		1 cycle: 1 step: -40 $\pm 2^{\circ}\text{C}$ / 30 ± 3 minutes 2 step: Ordinary temp. / 5 minutes min 3 step: +105 $\pm 2^{\circ}\text{C}$ / 30 ± 3 min 4 step: Ordinary temp. / 10 to 15 minutes min Total of 100cycles Then measured after exposure in the room condition for 24 ± 2 hours

9.Specification of Packaging

9.1 Appearance and Dimensions of plastic tape

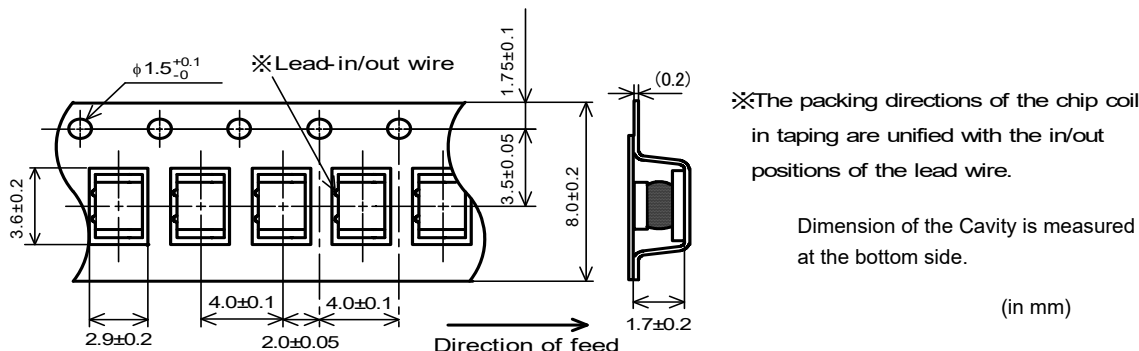

9.2 Specification of Taping

- (1) Packing quantity (standard quantity)
2,000 pcs / reel
- (2) Packing Method
Products shall be packed in the each embossed cavity of plastic tape and sealed by cover tape.
- (3) Sprocket hole
The sprocket holes are to the right as the tape is pulled toward the user.
- (4) Spliced point
Plastic tape and Cover tape has no spliced point.
- (5) Missing components number
Missing components number within 0.025 % of the number per reel or 1 pc., whichever is greater, and are not continuous. The specified quantity per reel is kept.

9.3 Pull Strength

Embossed carrier tape	10N min.
Cover tape	5N min.

9.4 Peeling off force of cover tape

Speed of Peeling off	300mm/min
Peeling off force	0.2 to 0.7N (minimum value is typical)

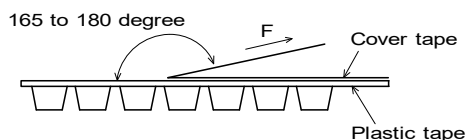

11. Notice

This product is designed for solder mounting.
Please consult us in advance for applying other mounting method such as conductive adhesive.

11.1 Land pattern designing

Recommended land patterns for flow and reflow soldering are as follows:
These have been designed for Electric characteristics and solderability.
Please follow the recommended patterns. Otherwise, their performance which includes electrical performance or solderability may be affected, or result to "position shift" in soldering process.

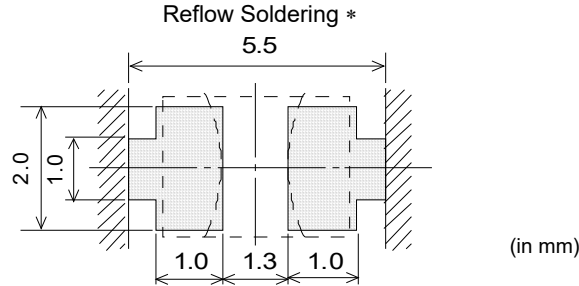

11.2 Flux, Solder

Flux	<ul style="list-style-type: none"> • Use rosin-based flux. • Don't use highly acidic flux with halide content exceeding 0.2(wt)% (chlorine conversion value). • Don't use water-soluble flux.
Solder	<ul style="list-style-type: none"> • Use Sn-3.0Ag-0.5Cu solder • Standard thickness of solder paste : 200µm to 300µm

Other flux (except above) Please contact us for details, then use.

11.3 Reflow soldering conditions

- Pre-heating should be in such a way that the temperature difference between solder and product surface is limited to 150°C max. Cooling into solvent after soldering also should be in such a way that the temperature difference is limited to 100°C max. Insufficient pre-heating may cause cracks on the product, resulting in the deterioration of product quality.
- Standard soldering profile and the limit soldering profile is as follows. The excessive limit soldering conditions may cause leaching of the electrode and / or resulting in the deterioration of product quality.

Soldering profile

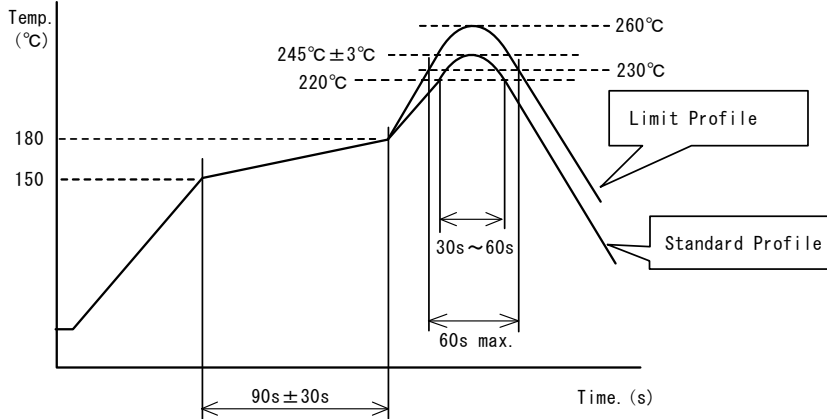

	Standard Profile	Limit Profile
Pre-heating	150~180°C、90s±30s	
Heating	above 220°C、30s~60s	above 230°C、60s max.
Peak temperature	245±3°C	260°C
Cycle of reflow	2 times	2 times

11.4 Reworking with soldering iron.

The following conditions must be strictly followed when using a soldering iron.

Pre-heating	150°C, 1 min
Tip temperature	350°C max.
Soldering iron output	80W max.
Tip diameter	φ 3mm max.
Soldering time	3(+1,-0)s
Times	2 times

Note : Do not directly touch the products with the tip of the soldering iron in order to prevent the crack on the products due to the thermal shock.

11.5 Solder Volume

- Solder shall be used not to be exceeded the upper limits as shown below.
- Accordingly increasing the solder volume, the mechanical stress to Chip is also increased. Exceeding solder volume may cause the failure of mechanical or electrical performance.

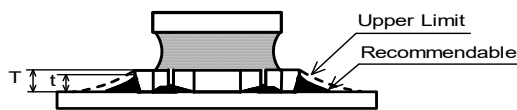

$$1/3T \leq t \leq T$$

(T: Lower flange thickness)

11.6 Product's location

The following shall be considered when designing and laying out P.C.B.'s.

- (1) P.C.B. shall be designed so that products are not subject to the mechanical stress due to warping the board.

[Products direction]

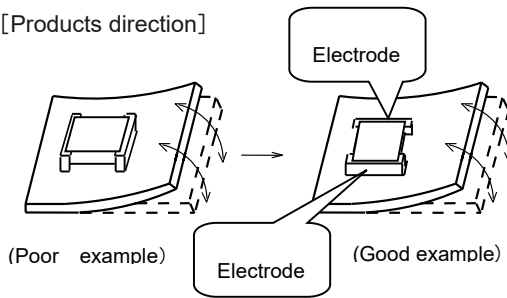

The electrode part of the products should be located like the picture to the mechanical stress.

- (2) Components location on P.C.B. separation.

It is effective to implement the following measures, to reduce stress in separating the board. It is best to implement all of the following three measures; however, implement as many measures as possible to reduce stress.

Contents of Measures	Stress Level
(1) Turn the mounting direction of the component parallel to the board separation surface.	A > D *1
(2) Add slits in the board separation part.	A > B
(3) Keep the mounting position of the component away from the board separation surface.	A > C

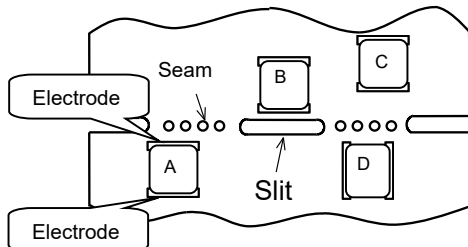

*1 A > D is valid when stress is added vertically to the perforation as with Hand Separation. If a Cutting Disc is used, stress will be diagonal to the PCB, therefore A > D is invalid.

- (3) Mounting Components Near Screw Holes

When a component is mounted near a screw hole, it may be affected by the board deflection that occurs during the tightening of the screw. Mount the component in a position as far away from the screw holes as possible.

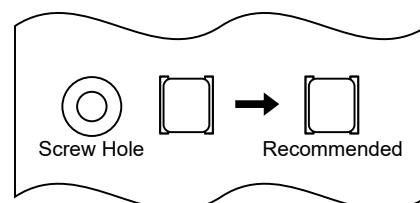

11.7 Cleaning Conditions

Products shall be cleaned on the following conditions.

- (1) Cleaning temperature shall be limited to 60°C max.(40°C max for IPA.)
- (2) Ultrasonic cleaning shall comply with the following conditions with avoiding the resonance phenomenon at the mounted products and P.C.B.
Power : 20 W / l max. Frequency : 28kHz to 40kHz Time : 5 minutes max.
- (3) Cleaner
 1. Alternative cleaner
 - Isopropyl alcohol (IPA)
 2. Aqueous agent
 - PINE ALPHA ST-100S
- (4) There shall be no residual flux and residual cleaner after cleaning.
In the case of using aqueous agent, products shall be dried completely after rinse with de-ionized water in order to remove the cleaner.
- (5) Other cleaning
Please contact us.

11.8 Resin coating

The inductance value may change due to high cure-stress of resin to be used for coating/molding products.

An open circuit issue may occur by mechanical stress caused by the resin, amount/cured shape of resin, or operating condition etc. Some resin contains some impurities or chloride possible to generate chlorine by hydrolysis under some operating condition may cause corrosion of wire of coil, leading to open circuit.

So, please pay your careful attention when you select resin in case of coating/molding the products with the resin.

Prior to use the coating resin, please make sure no reliability issue is observed by evaluating products mounted on your board.

11.9 Caution for use

- Sharp material such as a pair of tweezers or other material such as bristles of cleaning brush, shall not be touched to the winding portion to prevent the breaking of wire.
- Mechanical shock should not be applied to the products mounted on the board to prevent the breaking of the core

11.10 Handling of a substrate

After mounting products on a substrate, do not apply any stress to the product caused by bending or twisting to the substrate when cropping the substrate, inserting and removing a connector from the substrate or tightening screw to the substrate. Excessive mechanical stress may cause cracking in the product.

Bending

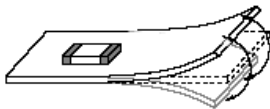

Twisting

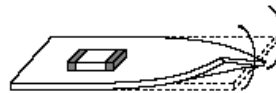
**11.11 Storage and Handling Requirements**



- (1) Storage period
Use the products within 12 months after delivered.
Solderability should be checked if this period is exceeded.
- (2) Storage conditions
 - Products should be stored in the warehouse on the following conditions.
Temperature : -10 ~ 40°C
Humidity : 15 to 85% relative humidity No rapid change on temperature and humidity
The electrode of the products is coated with solder. Don't keep products in corrosive gases such as sulfur, chlorine gas or acid, or it may cause oxidization of electrode, resulting in poor solderability.
 - Products should not be stored on bulk packaging condition to prevent the chipping of the core and the breaking of winding wire caused by the collision between the products.
 - Products should be stored on the palette for the prevention of the influence from humidity, dust and so on.
 - Products should be stored in the warehouse without heat shock, vibration, direct sunlight and so on.
- (3) Handling Condition
Care should be taken when transporting or handling product to avoid excessive vibration or mechanical shock.

12. ⚠ Note

- (1) Please make sure that your product has been evaluated in view of your specifications with our product being mounted to your product.
- (2) You are requested not to use our product deviating from the reference specifications.
- (3) The contents of this reference specification are subject to change without advance notice. Please approve our product specifications or transact the approval sheet for product specifications before ordering

Looking for pricing, stock, or lifecycle information?

Click below to explore more details on WIN SOURCE:

-  [View LQH32DN220K53L on WIN SOURCE](#)
-  [Murata Electronics North America Information](#)

Optimize Your Supply Chain with WIN SOURCE Solutions

-  Global Sourcing Solution
-  Obsolete Management
-  Cost Control Management
-  Shortage Management
-  Alternative Solution
-  Excess Inventory Management