



# THE DATASHEET OF LMB210S-TP



### Features

- Halogen Free. "Green" Device (Note 1)
- High Current Capability
- Low Profile Package
- Epoxy Meets UL 94 V-0 Flammability Rating
- Moisture Sensitivity Level 1
- Lead Free Finish/RoHS Compliant (Note 2) ("P" Suffix Designates RoHS Compliant. See Ordering Information)

### Maximum Ratings @ 25°C (Unless Otherwise Specified)

Parameter	Symbol	Value			Unit
		LMB24S	LMB26S	LMB210S	
Peak Repetitive Reverse Voltage	$V_{RRM}$	40	60	100	V
Working Peak Reverse Voltage	$V_{RWM}$				
DC Blocking Voltage	$V_R$				
RMS Reverse Voltage	$V_{RMS}$	28	42	70	V
Average Rectified Forward Current	$I_{F(AV)}$	2			A
Non-Repetitive Peak Surge Current @ 8.3ms Half Sine Wave	$I_{FSM}$	50			A
Current Squared Time @ 1ms ≤ t ≤ 8.3ms	$I^2t$	10			A <sup>2</sup> s

### Marking code

Part Number	Marking Code
LMB24S	LMB24S
LMB26S	LMB26S
LMB210S	LMB210S

### Internal Structure

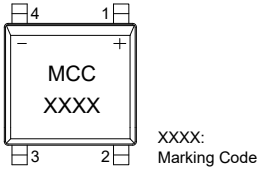
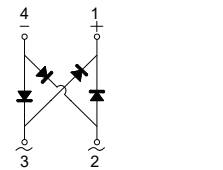
Pin	Description	Simplified Outline	Graphic Symbol
1	Anode		
4	Cathode		
2&3	AC		

Note: 1. Halogen free "Green" products are defined as those which contain <900ppm bromine, <900ppm chlorine (<1500ppm total Br + Cl) and <1000ppm antimony compounds.

2. High temperature solder exemption applied, see EU directive annex 7a.

**& Amp**  
**Gi fZUW' Aci bh**  
**GW ch\_mBridge**  
**F YWJZYf**  
**40 to 100 Volts**

### LMBS-1

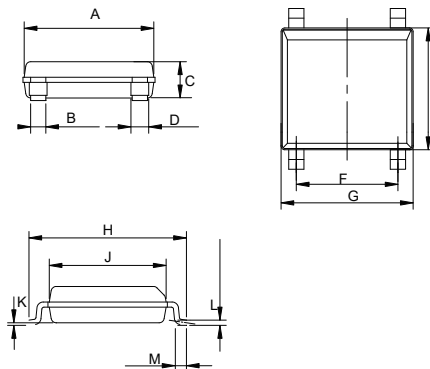

DIM	DIMENSIONS				NOTE
	INCHES		MM		
	MIN	MAX	MIN	MAX	
A	0.197	0.205	4.90	5.20	
B	0.024		0.60		
C	---	0.059	---	1.50	
D	0.024	0.032	0.60	0.80	
E	---	0.189	---	4.80	
F	0.150	0.165	3.80	4.20	
G	---	0.209	---	5.30	
H	0.236	0.252	6.00	6.60	
J	0.177	0.185	4.30	4.70	
K	0.0009	0.004	0.02	0.21	
L	0.006	0.012	0.15	0.30	
M	0.017	0.031	0.25	0.80	

### Suggested Solder Pad Layout

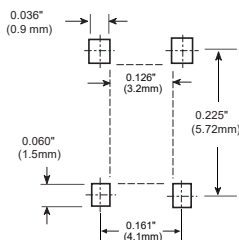

### Thermal characteristics

Symbol	Parameter	Conditions	Min	Typ	Max	Unit
$T_J$	Operating Junction Temperature Range	LMB24S	-55		125	°C
$T_J$	Operating Junction Temperature Range	LMB26S~LMB210S	-55		150	°C
$T_{stg}$	Storage Temperature Range		-55		150	°C
$R_{th(J-L)}$	Thermal Resistance from Junction to Lead			25		°C/W
$R_{th(J-A)}$	Thermal Resistance from Junction to Ambient			62.5		°C/W

### Electrical Characteristics @ 25°C Unless Otherwise Specified

Parameter	Symbol	Test Conditions	Min	Typ	Max	Unit
Forward Voltage	$V_F$	$I_F=1A; T_J=25^\circ C$ $I_F=2A; T_J=25^\circ C$ $I_F=1A; T_J=25^\circ C$ $I_F=2A; T_J=25^\circ C$ $I_F=1A; T_J=25^\circ C$ $I_F=2A; T_J=25^\circ C$		0.40	0.50	V
				0.50		
				0.47		
				0.59		
Reverse Current	$I_R$	at Rated $V_R; T_J=25^\circ C$ at Rated $V_R; T_J=125^\circ C$ at Rated $V_R; T_J=25^\circ C$ at Rated $V_R; T_J=125^\circ C$			0.1	mA
				20		
				0.01		
				5		
Junction Capacitance	$C_J$	$V_R=4V; f=1MHz; T_J=25^\circ C$		125		pF
				90		
				60		

## Curve Characteristics

Fig. 1 - Forward Current Derating Curve

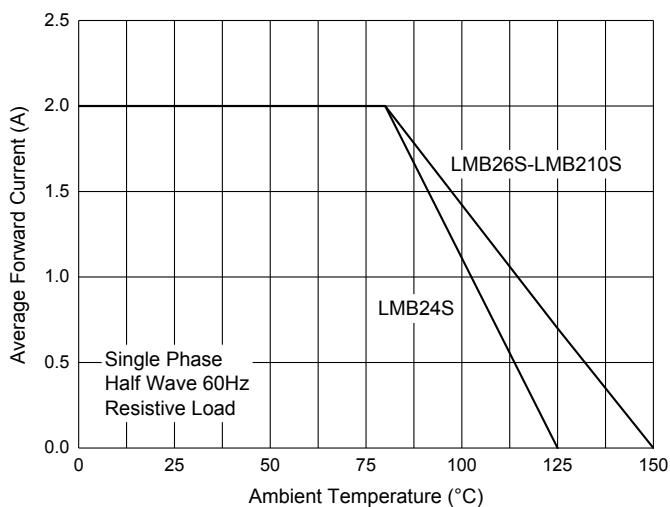

Fig. 2 - Maximum Non-Repetitive Peak Forward Surge Current

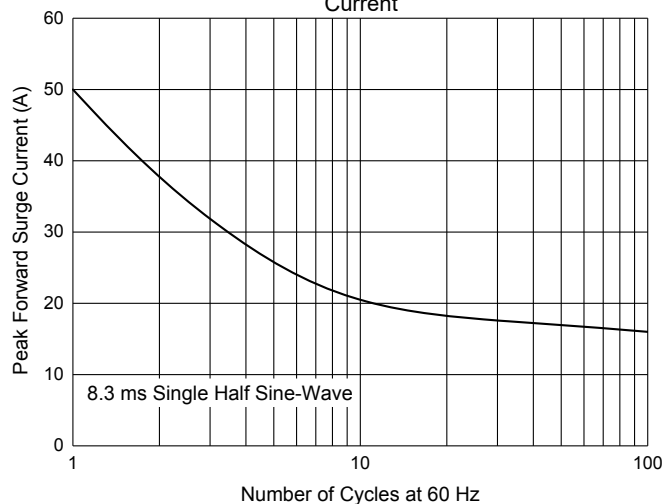

Fig. 3 - Typical Forward Characteristics

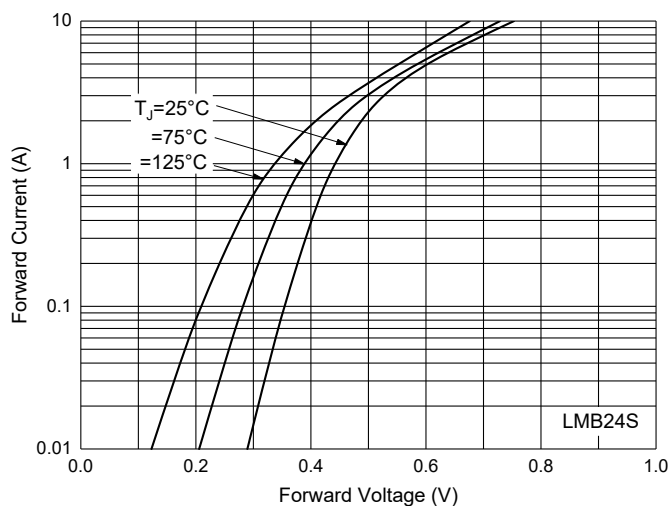

Fig. 4 - Typical Reverse Leakage Characteristics

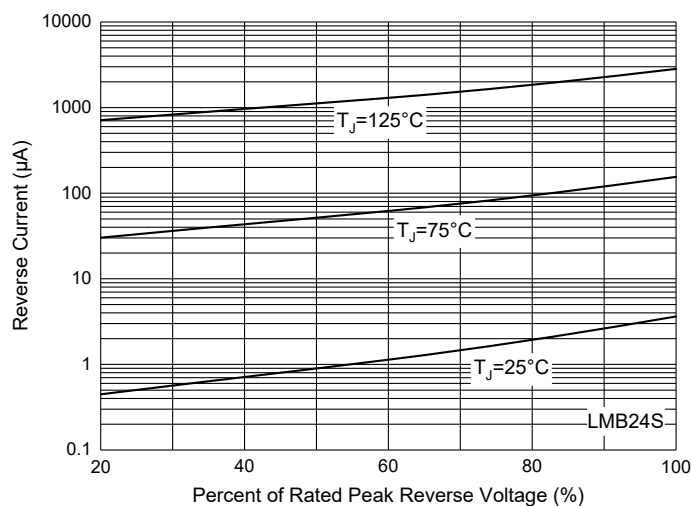

Fig. 5 - Typical Forward Characteristics

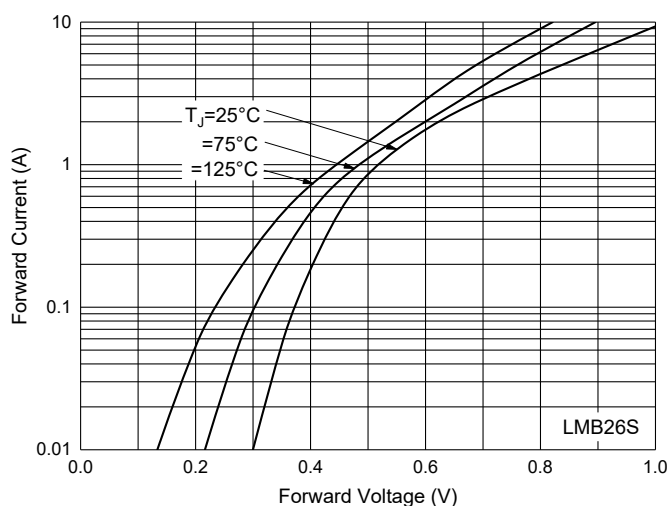
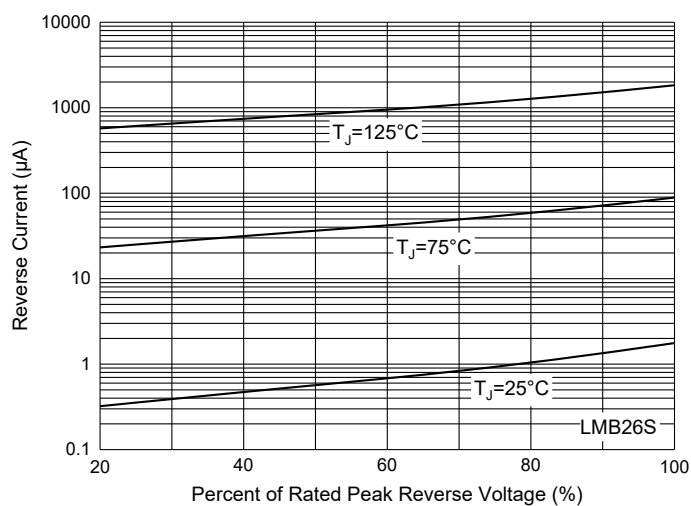

Fig. 6 - Typical Reverse Leakage Characteristics



**Curve Characteristics**

Fig. 7 - Typical Forward Characteristics

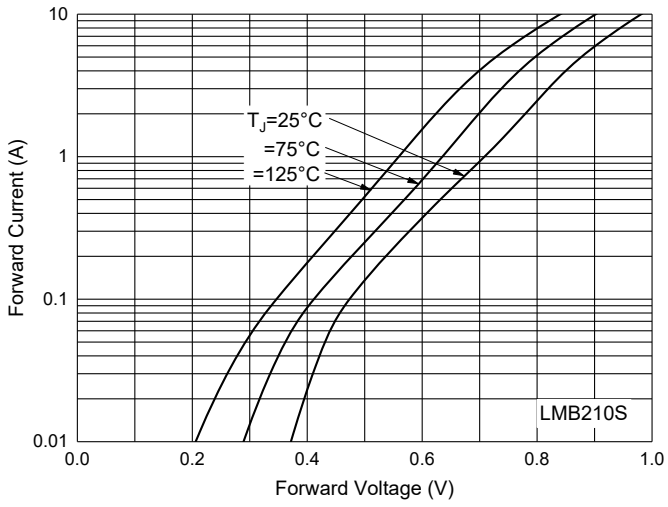

Fig. 8 - Typical Reverse Leakage Characteristics

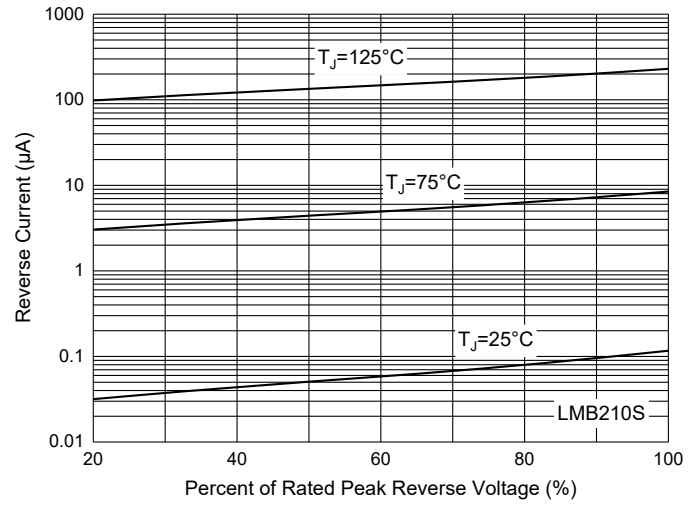
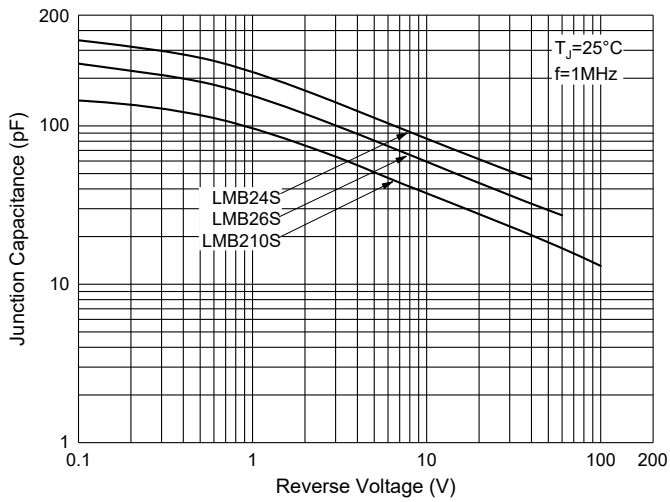

Fig. 9 - Typical Capacitance Characteristics



## Ordering Information

Device	Packing
Part Number-TP	Tape&Reel:5Kpcs/Reel

### \*\*\*IMPORTANT NOTICE\*\*\*

**Micro Commercial Components Corp.** reserves the right to make changes without further notice to any product herein to make corrections, modifications , enhancements , improvements , or other changes . **Micro Commercial Components Corp** . does not assume any liability arising out of the application or use of any product described herein; neither does it convey any license under its patent rights ,nor the rights of others . The user of products in such applications shall assume all risks of such use and will agree to hold **Micro Commercial Components Corp** . and all the companies whose products are represented on our website, harmless against all damages. **Micro Commercial Components Corp.** products are sold subject to the general terms and conditions of commercial sale, as published at <https://www.mccsemi.com/Home/TermsAndConditions>.

### \*\*\*LIFE SUPPORT\*\*\*

MCC's products are not authorized for use as critical components in life support devices or systems without the express written approval of Micro Commercial Components Corporation.

### \*\*\*CUSTOMER AWARENESS\*\*\*

Counterfeiting of semiconductor parts is a growing problem in the industry. Micro Commercial Components (MCC) is taking strong measures to protect ourselves and our customers from the proliferation of counterfeit parts. MCC strongly encourages customers to purchase MCC parts either directly from MCC or from Authorized MCC Distributors who are listed by country on our web page cited below. Products customers buy either from MCC directly or from Authorized MCC Distributors are genuine parts, have full traceability, meet MCC's quality standards for handling and storage. **MCC will not provide any warranty coverage or other assistance for parts bought from Unauthorized Sources.** MCC is committed to combat this global problem and encourage our customers to do their part in stopping this practice by buying direct or from authorized distributors.

## Looking for pricing, stock, or lifecycle information?

Click below to explore more details on WIN SOURCE:

- [View LMB210S-TP on WIN SOURCE](#)
- [Micro Commercial Co Information](#)

## Optimize Your Supply Chain with WIN SOURCE Solutions

- ✓ Global Sourcing Solution
- ✓ Obsolete Management
- ✓ Cost Control Management
- ✓ Shortage Management
- ✓ Alternative Solution
- ✓ Excess Inventory Management