

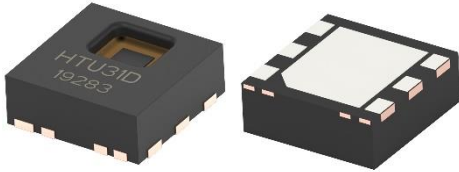

THE DATASHEET OF
10142048-22





HTU31 RH/T SENSOR IC

Relative Humidity & Temperature Sensor

- [HTU31D Digital RH/T Sensor](#)
- [HTU31V Analog RH/T Sensor](#)

CLICK HERE ›
CONNECT WITH A SPECIALIST

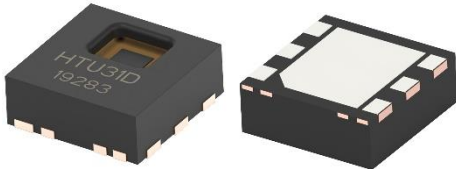

Features

- High Reliability and Robustness
- Fast Recovery after Saturation
- Fully Compatible with Reflow Process
- Fully Interchangeable without Calibration
- Serial Individual Marking for Traceability
- Lead Free
- Low Power Consumption

Applications

- Home Appliance
- HVAC
- Medical Respirators CPAP and Ventilators
- Industrial Transport / Cold Chain
- Humidifiers / Dehumidifier
- Meteorology
- Environmental Monitoring & Trackers
- IoT Applications
- IP Camera
- Water Leak Detector

[CLICK HERE ›](#)
CONNECT WITH A SPECIALIST

HTU31D RH/T SENSOR IC

Digital Relative Humidity & Temperature Sensor

Characteristics

- Fully calibrated, temperature compensated digital output
- High accuracy: $\pm 2\%RH$ and $\pm 0.2^{\circ}C$
- Fast humidity response time: 3s
- Long term drift: $< 0.1\%RH/year$
- Wide supply voltage range from 3V to 5.5V
- Low average current: 1 μA typical
- Compact 6-Pin DFN package: 2.5x2.5x0.9mm
- Fast I²C Interface with 2 configurable addresses
- Fully RoHS and REACH compliant

General Description

The HTU31 is one of the smallest and most accurate humidity sensors on the market. TE Connectivity precision engineering and 20+ years of experience in humidity and temperature combination sensors, enabled this new product with fast response time, precision measurement, low hysteresis, robustness to reflow assembly process and sustained performance even when exposed to extreme temperature [-40° to $125^{\circ}C$] and humidity [0%RH to 100%RH] environments.

HTU31 humidity & temperature sensor includes both digital (D) and analog (V) versions and combines multiple functions with an application-friendly operating supply voltage range from 3V to 5.5V.

HTU31 sensor is available in small and large volumes to meet the ever-changing demands of our customers.

PERFORMANCE SPECIFICATIONS

Relative Humidity Specifications

 $V_{dd} = 5V$ 25°C

Characteristics	Condition	Value	Units	Notes / Conditions
Humidity Operating Range	Max ¹	0 to 100	%RH	
Relative Humidity Accuracy	Typical	±2	%RH	Figure 1 Humidity Sensor Rating @25°C
Resolution	Typical	0.01	%RH	Table 11 Humidity and Temperature Conversion Parameters
Hysteresis	@25°C	±0.7	%RH	
Response Time ²	$\tau_{63\%}$	3	s	
Recovery Time after Condensation ³	$\tau_{100\%}$	10	s	
Long Term Drift ⁴	Typical	<0.1	%RH / year	

Table 1 Humidity Specifications

Temperature Specifications

 $V_{dd} = 5V$ 25°C

Characteristics	Condition	Value	Units	Notes / Conditions
Temperature Operating Range		-40 to 125	°C	
Temperature Accuracy	Typical	±0.2	°C	Figure 2 Temperature Sensor Rating
Resolution	Typical	0.016	°C	Table 11 Humidity and Temperature Conversion Parameters
Response Time ²	$\tau_{63\%}$	10	s	
Long Term Drift	Typical	0.04	°C / year	

Table 2 Temperature Specifications

¹ Cf. Figure 3 Humidity and Temperature Operating Range² With 1m.s⁻¹ air flow³ Measured according to AFNOR standard NFX 15-113, with 3 m.s⁻¹ air flow⁴ Typical application in regular environmental variation within optimum measurement range

Humidity Sensor Rating

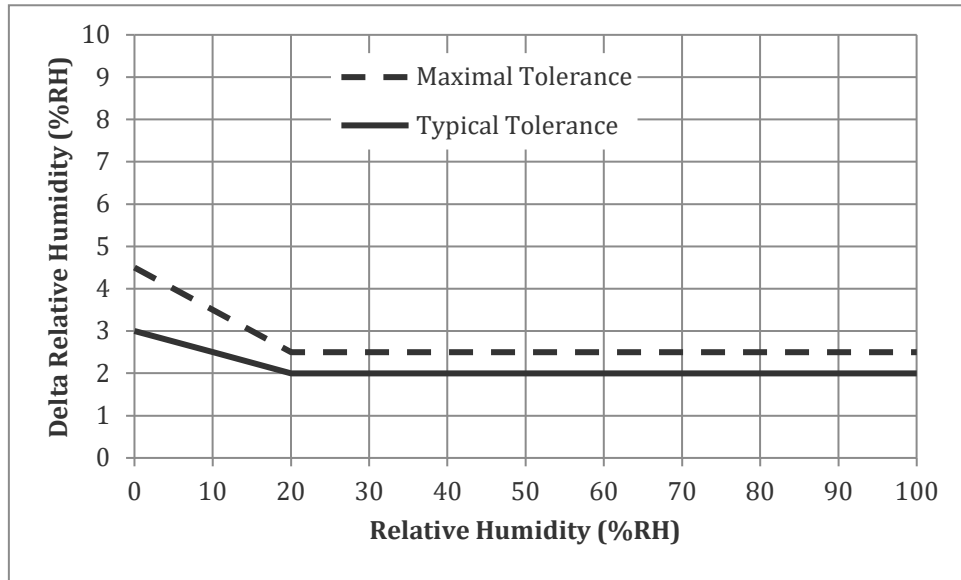

Figure 1 Humidity Sensor Rating @25°C

Temperature Sensor Rating

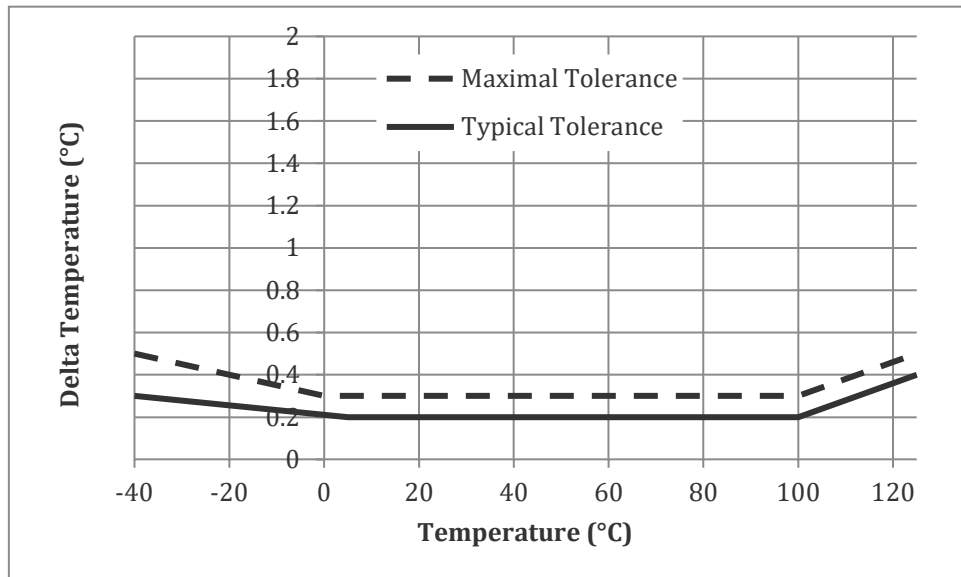

Figure 2 Temperature Sensor Rating

SENSOR INTEGRATION

Absolute Maximum Operating Conditions

Ratings	Symbol	Value	Unit	Notes / Conditions
Storage Temperature ⁵	Tstg	-40 to 200	°C	
Supply Voltage (Peak)	Vcc	5.5	Vdc	
Humidity Operating Range	RH	0 to 100	%RH	
Temperature Operating Range	Ta	-40 to +125	°C	
VDD to GND		-0.3 to 5.5	V	
Digital I/O pins (DATA/SCL) to GND		-0.3 to VDD +0.3	V	
ESD HBM (Human Body Model) ⁶		±8	kV	
ESD CDM (Charged Device Model) ⁷		750	V	
Latch Up Sensitivity ⁸		±300	mA	

Table 3 Maximum Operating Conditions

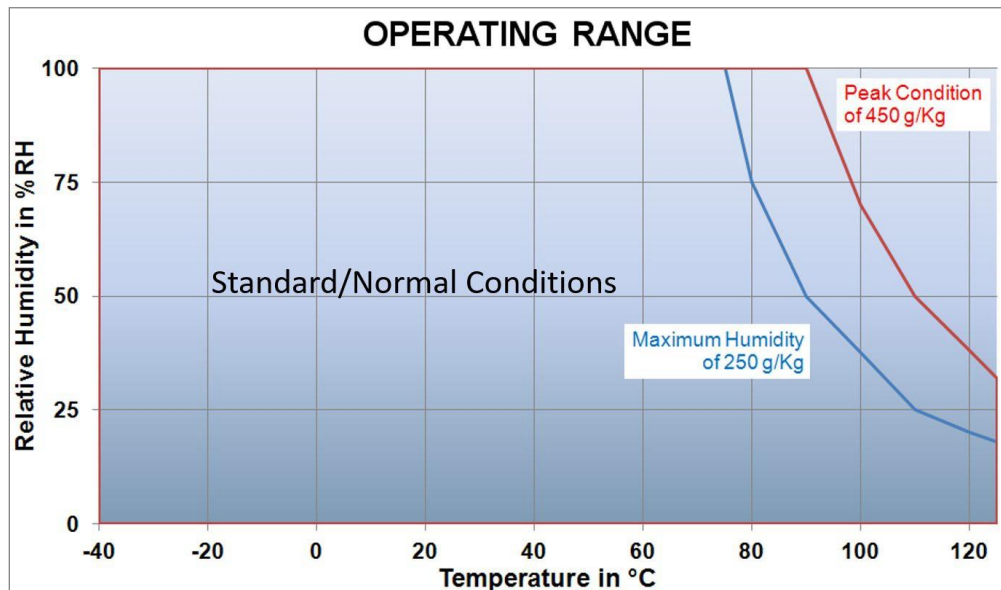

Figure 3 Humidity and Temperature Operating Range

The sensor should operate at peak condition less than 10% of the operating life. Exposure to absolute maximum humidity/temperature conditions for extended periods may temporarily induce an offset on RH measurement (+5%RH above accuracy specifications, which will recover over time) and accelerate its ageing.

⁵ Sensor in specifications after 1000h storage @125°C; No failure after 1000h storage @200°C

⁶ According to ANSI/ESDA/JEDEC JS-001-2017, AEC-Q100-002.

⁷ According to JESD22-C101, AEC-Q100-011

⁸ According to JESD78

HTU31D RH/T SENSOR IC

Digital Relative Humidity & Temperature Sensor

Electrical Specifications

$V_{dd} = 5V$ 25°C

Characteristics	Symbol	Min	Typ	Max	Unit	Notes / Conditions
Supply Voltage	V_{dd}	3.0	5.0	5.5	V	
Current Consumption	i_{dd}		0.13	0.40	μA	Sleep mode
			1.04		μA	Typical ⁹
			414		μA	Peak / Measuring mode
Power Dissipation			0.65	2.00	μW	Sleep mode
			5.20		μW	Typical ⁹
			2.07		mW	Peak / Measuring mode
Heater	R_{heat}	1.5	2.0	2.5	k Ω	$P_{heat} = \frac{V_{dd}^2}{R_{heat}}$
	P_{heat}	10	12.5	16	mW	

Table 4 Electrical Specifications

Timing Specifications

$V_{dd} = 5V$ 25°C

Characteristics	Symbol	Min	Typ	Max	Unit	Notes / Conditions
Power Up Time				1	ms	
Soft Reset Time				15	ms	
Duration of Reset Pulse			3		ms	Refer to Pin4 on Table 6 Pin Assignment
Humidity Conversion Time	$T_{conv\ hum}$		7.8		ms	Humidity OSR = 3 (0.007%RH)
			3.9		ms	Humidity OSR = 2 (0.010%RH)
			2.0		ms	Humidity OSR = 1 (0.014%RH)
			1.0		ms	Humidity OSR = 0 (0.020%RH)
Temperature Conversion Time	$T_{conv\ temp}$		12.1		ms	Temperature OSR = 3 (0.012°C)
			6.1		ms	Temperature OSR = 2 (0.016°C)
			3.1		ms	Temperature OSR = 1 (0.025°C)
			1.6		ms	Temperature OSR = 0 (0.040°C)

Table 5 Timing Specifications

⁹ One RH and temperature measurement per second, OSR0

INTERFACES

Pin Assignment

N°	Function	Description
1	SDA	Serial Data Output / Input
2	GND	Ground
3	IC_Add	Address Selection
4	RST	Reset
5	VDD	Supply Voltage
6	SCL	Clock

TOP VIEW

BOTTOM VIEW

Table 6 Pin Assignment

I²C Communication Pins (SDA / SCL)

SCL is used to synchronize the communication between microcontroller and HTU31D sensor. Since the interface consists of fully static logic there is no minimum SCL frequency. The SDA pin is used to transfer data in and out of the device. To send a command to HTU31D sensor, SDA is valid on the rising edge of SCL and shall remain stable while SCL is high. Following the falling edge of SCL, SDA value may be changed. To guaranty safe communication SDA shall be valid t_{QS} and t_{QH} before the rising and after the falling edge of SCL, respectively. To read data from HTU31D sensor, SDA is valid t_{VD} after SCL has gone low and remains valid until the next SCL falling edge.

An external pull-up resistor (e.g. 10kΩ¹⁰) on SCL and SDA is required to pull the signal high only for open collector or open drain technology microcontrollers. In most case, pull-up resistors are internally included in I/O microcontroller circuits.

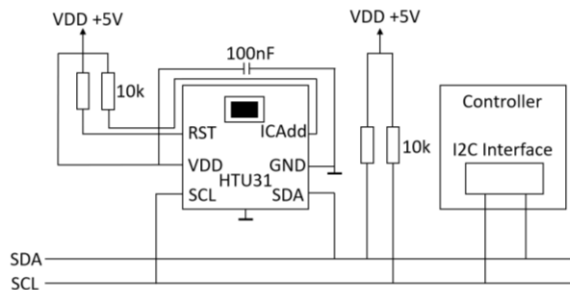

Figure 4 I2C Typical Application Circuit

Power Pins (VDD / GND)

Typical circuit includes a 100nF decoupling capacitor between VDD and GND, located as close as possible to the sensor. GND pin is internally connected to central pad. Depending on application electronic board thermal characteristics, soldering of this central pad may be recommended or not (cf. Thermal Resistance Information Page 15).

IC_Add Pin

The IC_Add pin allows the user to dynamically change sensor I2C address to connect multiple sensors on the same I2C network. The level applied to the IC_Add pin shall remain constant from the start to the end of the 2C communication (see Communication and Operation section). If IC_Add pin is not used, it is recommended to connect it to GND (I2C address 0x40) or VDD with a 10kΩ series resistance (I2C address 0x41) as represented in *Figure 4 I2C Typical Application Circuit*.

RST Pin

The RST pin can be used to generate a reset of the sensor. A minimum pulse of 1 μs is required to reliably trigger a sensor reset. If RST pin is not used, it is recommended to connect it to VDD with a 10kΩ series resistance.

¹⁰ Pull-up resistor value is valid if the HTU is alone on I²C bus functioning at 100kHz, otherwise please refer to UM10204, Rev. 6, April 4, 2014

COMMUNICATION AND OPERATION

I²C Address

HTU31 series has the capability to respond 2 distinct I²C addresses. This feature allows to use multiple sensors on the same I²C network and avoid address conflict with other components.

Hardwired Dynamic Address

The hardwired address is defined by the IC_ADD pin level (it sets the LSB value). It can be used to connect 2 sensors on the same I²C network (one wired to VDD, the other to GND). To connect more than 2 sensors on the same I²C network, individual IC_ADD lines can be used.

IC_ADD Pin level	Sensor I ² C address (Hex)
GND	0x40
VDD	0x41

Table 7 Sensor I²C Address

Software Address

By default, the software address is not activated however it can be set to any I²C valid address by TE Connectivity upon request.

Input / Output Characteristics

Characteristics	Symbol	Min	Max	Unit
Output Low Voltage	VOL	0.0 V _{DD}	0.2 V _{DD}	V
Output High Voltage	VOH	0.8V _{DD}	V _{DD}	V
Input Low Voltage	VIL	0.0 V _{DD}	0.3 V _{DD}	V
Input High Voltage	VIH	0.7 V _{DD}	V _{DD}	V

Table 8 Input and Output Characteristics

Timing Specifications of Digital input/output pads for I²C Fast Mode

Characteristics	Symbol	Min	Typ	Max	Unit	Notes / Conditions
SCL frequency	f _{scl}		400	1000	kHz	Refer to UM10204
SCL high time	t _{high}	40			ns	
SCL low time	t _{low}	60			ns	
SCL setup to falling SDA	t _{su:sta}	20			ns	repeated start
SCL hold to falling SDA	t _{hd:sta}	20			ns	signaling start
SDA setup to SCL rising	t _{su:dat}	20			ns	
SDA hold to SCL falling	t _{hd:dat}	20			ns	SDA input
SDA delay to SCL falling	t _{su:dout}		5	20	ns	SDA output, internal chip delay without loading

Table 9 Timing Specifications for I²C Fast Mode

HTU31D RH/T SENSOR IC

Digital Relative Humidity & Temperature Sensor

Sensor Functions

General

Every I²C message starts with the start condition and it is ended with the stop condition. Every command consists of two bytes: the address byte and the command byte. The sensor address is 1000'00x. The x in the address is defined with the value at the input of the I2C_LSB pin. If I2C_LSB = 0 then the address will be 1000'000 (0x40), while if the I2C_LSB = 1 then the address will be 1000'001 (0x41). This feature allows two sensors to operate on the same I2C bus.

Command Byte	7	6	5	4	3	2	1	0
Command Name	CMD	CMD	CMD	CMD	CMD	CMD	CMD	Stop
Conversion	0	1	0	OSRRH1	OSRRH0	OSRT1	OSRT0	X
Read T & RH	0	0	0	0	0	0	0	X
Read RH	0	0	0	1	0	0	0	X
Reset	0	0	0	1	1	1	1	X
Heater on	0	0	0	0	0	1	0	X
Heater off	0	0	0	0	0	0	1	X
Read serial number	0	0	0	0	1	0	1	X
Read Diagnostic	0	0	0	0	1	0	0	X

Table 10 User Commands

Temperature & Humidity Measurement Sequence

- 1) Execute "Conversion" command with the desired resolution to perform measurement and load it in sensor memory
 - 2) Wait for the conversion time (see *Table 5 Timing Specifications*)
 - 3) Execute "Read T & RH" or "Read RH" command to read measurement
- Note: Humidity and temperature values will be updated by the "Conversion" command.

Conversion

The conversion command triggers a single temperature and humidity conversion with Selected Resolution OSR:

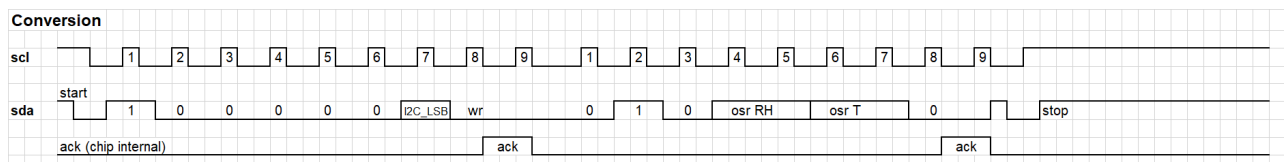

Figure 5 Conversion Command

Abbreviation	Binary value	Description
osrRH1..osrRH0	11	Humidity OSR = 3 (0.007%RH)
	10	Humidity OSR = 2 (0.010%RH)
	01	Humidity OSR = 1 (0.014%RH)
	00	Humidity OSR = 0 (0.020%RH)
osrT1..osrT0	11	Temperature OSR = 3 (0.012°C)
	10	Temperature OSR = 2 (0.016°C)
	01	Temperature OSR = 1 (0.025°C)
	00	Temperature OSR = 0 (0.040°C)

Table 11 Humidity and Temperature Conversion Parameters and Associated Resolution

HTU31D RH/T SENSOR IC

Digital Relative Humidity & Temperature Sensor

Read T & RH

The Read T & RH command can be used either to read only the temperature or both the temperature and the humidity. The 16 temperature data bits are followed by an 8-bit temperature CRC. The 16 RH data bits are followed by an 8-bit RH CRC. The data reading can be stopped any time by sending a not acknowledge (nack) and stop sequence. This can be used, for example, when only the temperature data is needed.

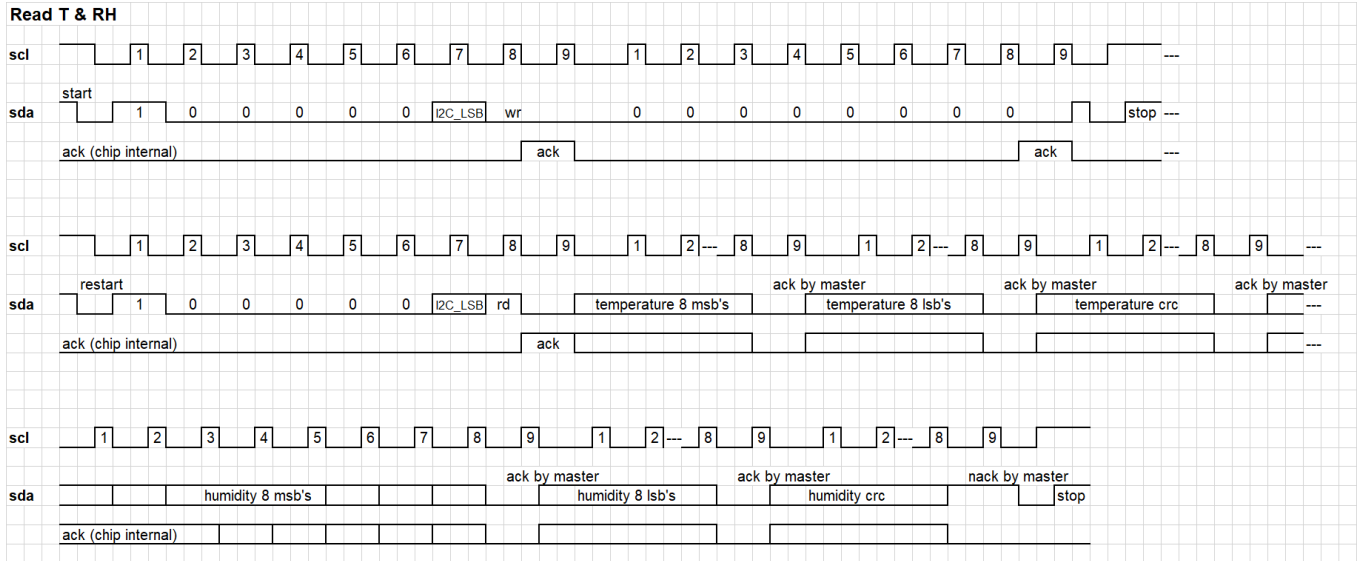

Figure 6 Read T&RH command

Note: The not acknowledge (nack) and stop at the end of the reading is mandatory, otherwise the chip may block the SDA.

Read RH

The Read RH command is available when only the relative humidity (RH) data is needed. The 16 RH data bits are followed by an 8-bit CRC. When the CRC is not required, the data reading can be stopped after the 16 RH data bits by sending a not acknowledge (nack) and stop sequence.

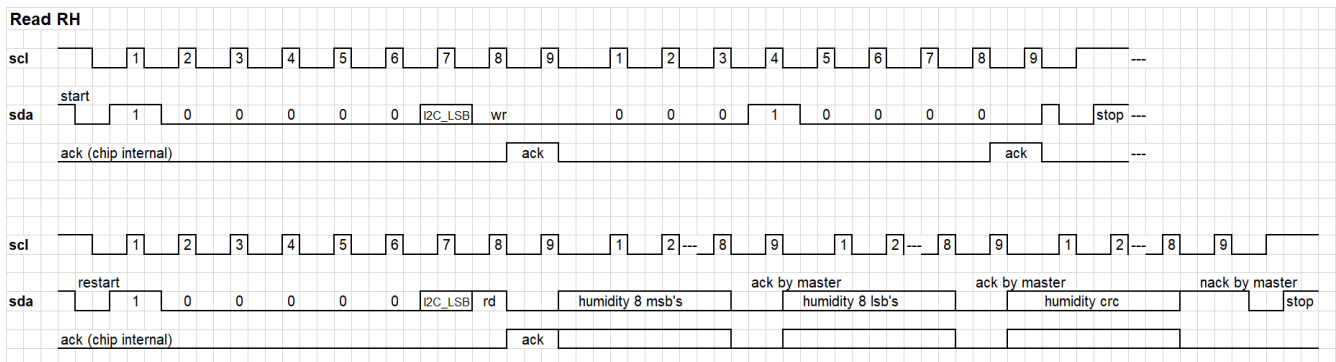

Figure 7 Read RH Command

Note: The not acknowledge (nack) and stop at the end of the reading is mandatory, otherwise the chip may block the SDA.

HTU31D RH/T SENSOR IC

Digital Relative Humidity & Temperature Sensor

Reset

Reset command is used to reboot the HTU31D switching the power off and on again. Upon reception of this command, the HTU31D reinitializes and starts operation according to the default settings. The reset takes less than 5ms.

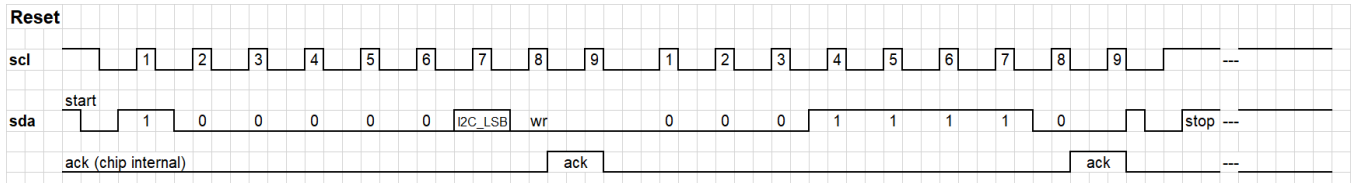

Figure 8 Soft Reset Command

Heater on

The sensor includes a built-in heater which can be switched on by the following command:

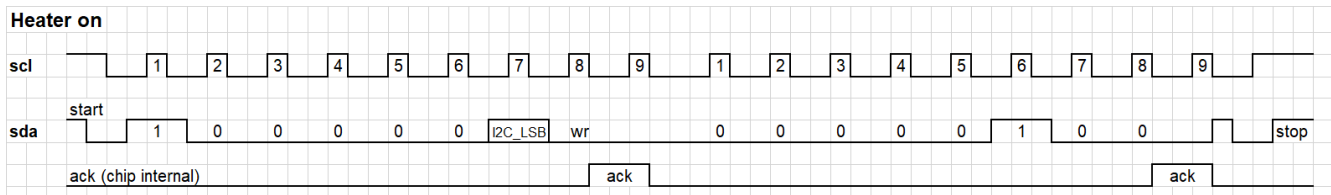

Figure 9 Heater on Command

Heater off

To switch the heater off, a reset command or the following command must be applied:

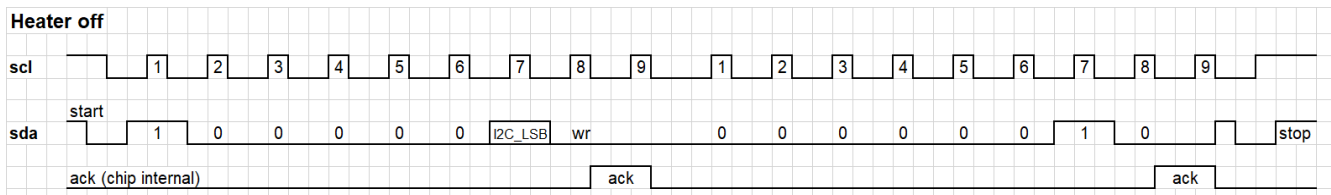

Figure 10 Heater off Command

Read serial number

For identification of the chip, the serial number can be read. The 24-bit serial number data is followed by an 8-bit CRC:

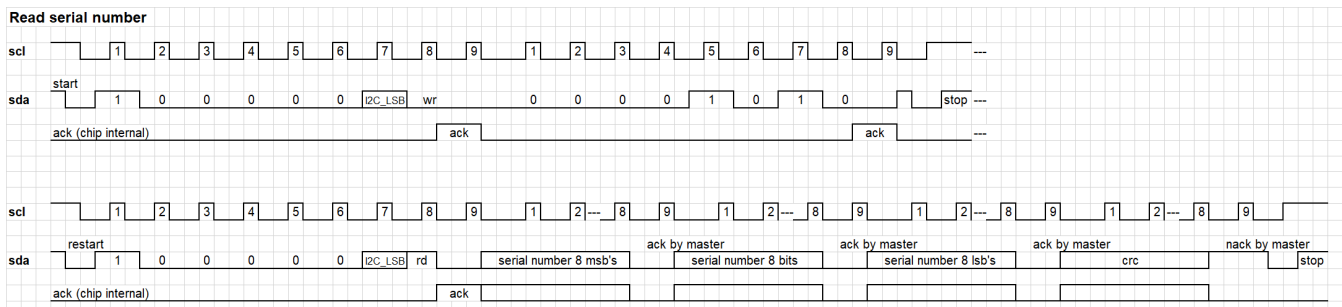

Figure 11 Read serial number Command

Note: The not acknowledge (nack) and stop at the end of the reading is mandatory, otherwise the chip may block the SDA.

HTU31D RH/T SENSOR IC

Digital Relative Humidity & Temperature Sensor

Read Diagnostic

A diagnostic register is available to check if the humidity and temperature are working properly, if the humidity or temperature are out of specified range, the heater and the memory status:

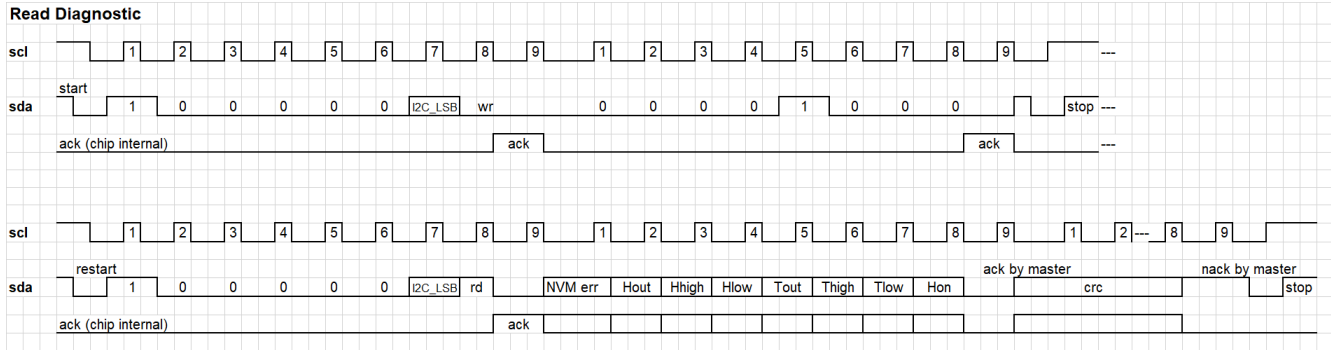

Figure 12 Read Serial number command

Note: The not acknowledge (nack) and stop at the end of the reading is mandatory, otherwise the chip may block the SDA.

Diagnostic Register

7	6	5	4	3	2	1	0
NVM error (NVM err)	Humidity under/overrun (Hout)	Humidity high error (Hhigh)	Humidity low error (Hlow)	Temperature under/overrun (Tout)	Temperature high error (Thigh)	Temperature low error (Tlow)	Heater on (Hon)

Table 12 Diagnostic Register

Abbreviation	Description
NVM error (NVM err)	bit is set if the CRC of the NVM has failed (CRC is done on the register copy)
Humidity under/overrun (Hout)	bit is set if the humidity is truncated to 0 or the max value of $2^{16}-1$
Humidity high error (Hhigh)	bit is set if the humidity calculation results above 120 %RH
Humidity low error (Hlow)	bit is set if the humidity calculation results below -10 %RH
Temperature under/overrun (Tout)	bit is set if the temperature is truncated to 0 or the max value of $2^{16}-1$
Temperature high error (Thigh)	bit is set if the temperature calculation results above 150 °C
Temperature low error (Tlow)	bit is set if the temperature calculation results below -50 °C
Heater on (Hon)	bit is set if the heater is on

Table 13 Diagnostic Register Bits Description

CRC

CRC Checksum

HTU31D sensor includes a CRC-8 checksum for error detection. The polynomial used is $X^8 + X^5 + X^4 + 1$.

Basic Considerations

CRC stands for Cyclic Redundancy Check. It is one of the most effective error detection schemes and requires a minimal amount of resources.

The types of detectable errors with CRC implemented in HTU31D sensors are:

- Any odd number of errors anywhere in the data transmission
- All double-bit errors anywhere in the data transmission
- Any cluster of errors that can be contained within an 8-bit window (1-8 bits incorrect)
- Most larger clusters of errors

A CRC is an error-detecting code commonly used in digital networks and storage devices to detect accidental changes to raw data.

Blocks of data entering these systems get a short check value attached, based on the remainder of a polynomial division of their contents; on retrieval the calculation is repeated, and corrective action can be taken against presumed data corruption if the check values do not match.

CRCs are so called because the check (data verification) value is a redundancy (it expands the message without adding information) and the algorithm is based on cyclic codes. CRCs are popular because they are simple to implement in binary hardware, easy to analyze mathematically, and particularly effective to detect common errors caused by noise in transmission channels. As the check value has a fixed length, the function that generates it is occasionally used as a hash function.

When HTU31D operates with standard I²C protocol, an 8-bit CRC can be used to detect transmission errors. The CRC covers all read data transmitted by the sensor. CRC properties for HTU31D communicating with I²C protocol are listed below:

CRC with I²C protocol	
Generator polynomial	$X^8 + X^5 + X^4 + 1$
Initialization	0x00
Protected data	Read data
Final Operation	none

Table 14 I²C CRC Properties

CRC Calculation

To compute a n-bit binary CRC, line bits representing the input in a row, and position the (n+1)-bit pattern representing the CRC's divisor (called a "polynomial") underneath the left-hand end of the row. This is first padded with zeroes corresponding to the bit length n of the CRC. If the input bit above the leftmost divisor bit is 0, do nothing. If the input bit above the left most divisor bit is 1, the divisor is XORed into the input (in other words, the input bit above each 1-bit in the divisor is toggled). The divisor is then shifted one bit to the right, and the process is repeated until the divisor reaches the right-hand end of the input row. Since the left most divisor bit zeroed every input bit it touched, when this process ends the only bits in the input row that can be non-zero are the n bits at the right-hand end of the row. These n bits are the remainder of the division step and will also be the value of the CRC function. The validity of a received message can easily be verified by performing the above calculation again, this time with the check value added instead of zeroes. The remainder should equal zero if there are no detectable errors.

CRC Examples

The input message 11011100 (0xDC) will have as result 01111001 (0x79).

The input message 01101000 00111010 (0x683A) will have as result 01111100 (0x7C).

The input message 01001110 1000101 (0x4E85) will have as result 01101011 (0x6B).

Conversion of Signal Outputs

Measurement data are transferred as 16-bit values (unsigned integer).

Converting those raw values into a physical measurement can be achieved using the following formulas:

Relative Humidity Conversion

From the relative humidity output S_{RH} (decimal), the relative humidity RH (%RH) is obtained by the following formula, this formula being applicable whatever selected resolution (OSR):

$$RH = 100 \times \frac{S_{RH}}{2^{16} - 1}$$

Temperature Conversion

From the temperature output S_T (decimal), the temperature T (°C) is obtained by the following formula, this formula being applicable whatever selected resolution (OSR):

$$T = -40 + 165 \times \frac{S_T}{2^{16} - 1}$$

Note: these formulas are only valid with decimal representation of S_T and S_{RH}

Dew Point Temperature Calculation

The dew point is the temperature at which the water vapor in the air becomes saturated and condensation begins.

The dew point is associated with relative humidity. A high relative humidity indicates that the dew point is closer to the current air temperature. Relative humidity of 100% indicates that the dew point is equal to the current temperature (and the air is maximally saturated with water). When the dew point stays constant and temperature increases, relative humidity will decrease.

Partial Pressure (PP_{Tamb}) Calculation from Ambient Temperature

Partial Pressure (PP_{Tamb}) is calculated using temperature measurement from HTU31 sensor with the following formula:

$$PP_{Tamb} = 10^{\left[A - \frac{B}{(T_{amb} + C)} \right]}$$

PP_{Tamb} Partial Pressure in mmHg at Ambient Temperature

T_{amb} Ambient Temperature in °C, from HTU31

A, B, C Constants: A=8.1332; B=1762.39; C=235.66

Dew Point Temperature (T_d) Calculation from Partial Pressure (PP_{Tamb})

Dew point temperature (T_d) of the air is calculated using ambient relative humidity and temperature measurements from HTU31 sensor with the following formula:

$$T_d = - \left[\frac{B}{\log_{10} \left(RH_{amb} \times \frac{PP_{Tamb}}{100} \right) - A} + C \right]$$

PP_{Tamb} Partial Pressure in mmHg at Ambient Temperature

RH_{amb} Ambient Relative Humidity in %RH, from HTU31

T_{amb} Ambient Temperature in °C, from HTU31

T_d Calculated Dew Point in °C

A, B, C Constants: A=8.1332; B=1762.39; C=235.66

HTU31D RH/T SENSOR IC

Digital Relative Humidity & Temperature Sensor

PACKAGING AND ASSEMBLY INFORMATION

Package Outline

Bottom View

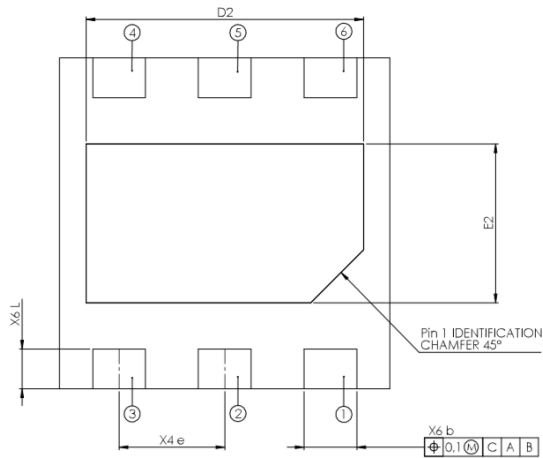

Side View

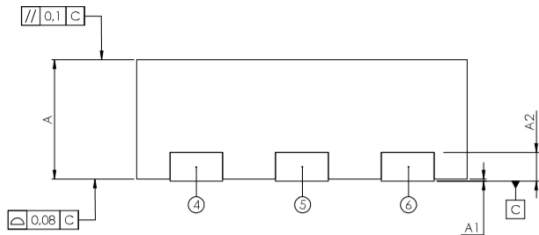

Description	"W" in the marking
HTU31 Digital	D
HTU31 Analog	V

Top View

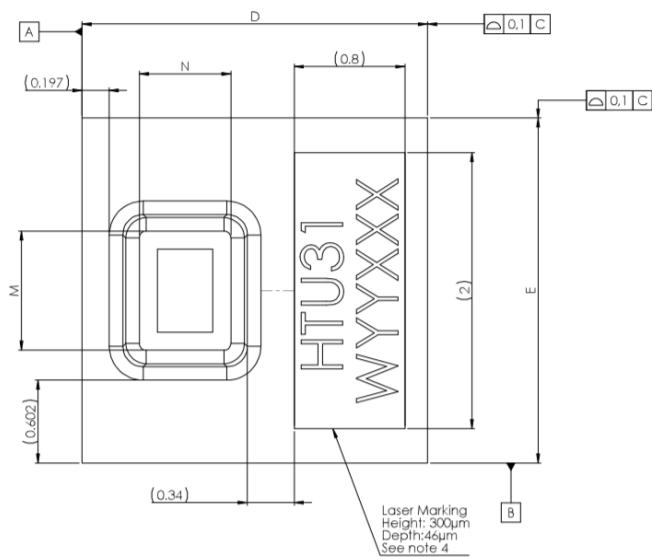

SYMBOL	COMMON					
	DIMENSIONS MILLIMETER			DIMENSIONS INCH		
	MIN.	NOM.	MAX.	MIN.	NOM.	MAX.
A	0.85	0.90	0.95	0.033	0.035	0.037
A1	0.00	0.02	0.05	0.000	0.001	0.002
A2	0.203 REF			0.008 REF		
b	0.35	0.40	0.45	0.014	0.016	0.018
D	2.45	2.50	2.55	0.096	0.098	0.100
D2	2.05	2.10	2.15	0.081	0.083	0.085
E	2.45	2.50	2.55	0.096	0.098	0.100
E2	1.15	1.20	1.25	0.045	0.047	0.049
e	0.80 BSC			0.031 BSC		
L	0.25	0.30	0.35	0.010	0.012	0.014
M	0.860 REF			0.034 REF		
N	0.660 REF			0.026 REF		

HTU31D RH/T SENSOR IC

Digital Relative Humidity & Temperature Sensor

Packaging Type

HTU31 is provided in DFN type package (Dual Flat No leads).
HTU31 sensor chip is mounted on a Cu and plated with Ni/Pd/Au lead frame.

Traceability Information

Sensor Marking

Each HTU31D sensor is laser marked with an alphanumeric code (cf. Top view Page14). The marking, engraved on two lines, contains following information:

- The first line denotes the sensor type: HTU31.
- The second line noted WYYXXX denotes Output mode and Date Code:
 - **W** refers to Output mode: D = Digital (I²C) Output; V = Voltage Analog Output
 - **YY** digits defines the manufacturing year: 21=2021, 22=2022.
 - **XXX** refers to the day number.

Reel Package Marking

Reels are also labeled for lot identification and additional traceability information, as shown below:

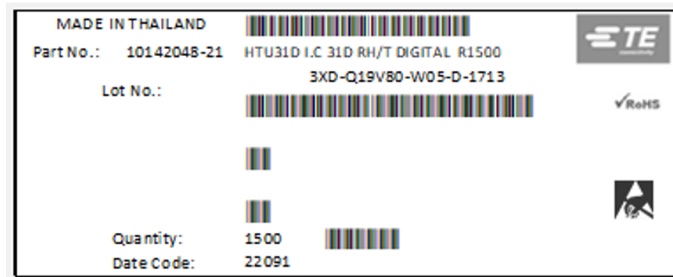

The reel label includes:

- Part Number
- Individual Lot Number (3X stands for HTU31, D for Digital Output, Individual Lot Number)
- Quantity
- Date Code

Thermal Resistance Information

Characteristics	Symbol	Value	Unit
Junction-to-Ambient Thermal Resistance	θ_{JA}	55	°C/W
Junction-to-Board Thermal Resistance	θ_{JB}	16	°C/W
Junction-to-Case Thermal Resistance	θ_{JC}	3	°C/W
Junction-to-Top Characterization Parameter	ψ_{JT}	2	°C/W

Table 15 Thermal Resistance Values

Values are based on simulations and are offered for general reference use.

Depending on application electronic board thermal characteristics, soldering of central pad may be recommended or not.
In case of application electronic board (excluding HTU31) low self-heating, soldering of central pad is recommended.
In case of application electronic board (excluding HTU31) high self-heating, soldering of central pad may not be recommended.

Handling & Storage Recommendations

To guaranty and preserve the high-quality performance of the HTU31 sensor, the following recommendations shall be respected concerning storage and packaging:

Prior sensors use or assembly, it is recommended to store them in their original sealed anti ESD packaging. If sensors have been removed from their original packaging, it is recommended to keep them in anti-static shielded ESD bags.

HTU31 sensor shall not be in contact with volatile chemicals such as solvents or other organic compounds that could induce a sensing element pollution or damage.

HTU31 sensor is classified MSL level 1 according to IPC/JEDEC J-STD-020.1 for storage, packaging and handling.

The typical shelf life is 1 year at temperature below 30°C and relative humidity below 85%RH.

HTU31 sensor shall be protected from ESD (Electrostatic Discharge) and shall be handled in ESD protected areas (EPA) under protected and standard controlled conditions (ground with wrist-straps, ground all non-insulating and conductive objects, operate only in grounded conductive floor).



Figure 16 Protection against ESD mandatory

Soldering and Assembly Instructions

HTU31 sensor is designed to withstand soldering profile according to IPC/JEDEC J-STD-020 with peak temperatures at 260°C during up to 30sec for Pb-free assembly in reflow ovens.

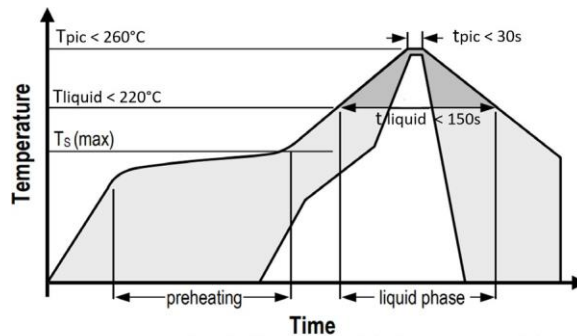

For temperatures above T_{liquid} , Ramp-up rate $< 3^{\circ}\text{C}/\text{sec}$ & Ramp-down rate $< 6^{\circ}\text{C}/\text{sec}$

Figure 17 Reflow Soldering profile according to JEDEC standard

Standard pick & place equipment and vacuum nozzles for standard DFN packages may be used for assembly of HTU31 sensors.

For manual soldering contact time must be limited to 5 seconds at 350°C.

The use of “no clean” solder paste is recommended to avoid pollution or damage of RH sensing element.

In case of applications with exposure of the sensor to corrosive gases or condensed water (i.e. environments with high relative humidity) the soldering pads shall be sealed (e.g. conformal coating) to prevent loose contacts or short cuts.

No board wash shall be applied to HTU31 sensors without appropriate sensor upper surface adhesive tape protection.

No coating shall be applied to HTU31 sensors without appropriate sensor upper surface adhesive tape protection.

Immediately after soldering high thermal stress, HTU31 sensors may temporarily read a normal slight RH negative deviation ($< 1\%RH$) corresponding to sensing element extreme drying. This slight normal deviation will disappear after one or two days.

HTU31D RH/T SENSOR IC

Digital Relative Humidity & Temperature Sensor

ORDERING INFORMATION

Output Signal

D	I ² C Digital	Part Number HTU31x
V	Ratiometric Voltage	

Description	Quantity	Part number
HTU31D RH/T IC DIGITAL R400	400	10142048-20
HTU31D RH/T IC DIGITAL R1500	1500	10142048-21
HTU31D RH/T IC DIGITAL R5000	5000	10142048-22
HTU31V RH/T IC ANALOG R400	400	10142048-30
HTU31V RH/T IC ANALOG R1500	1500	10142048-31
HTU31V RH/T IC ANALOG R5000	5000	10142048-32
Demonstration Board HTU31D	1	10142605-10
Demonstration Board HTU31V	1	10142605-02

REVISION HISTORY

DATE	VERSION	PAGE(S)	CHANGES
January 2021	3	2 / 4 / 6 / 7 / 13	Update of Humidity Response Time, Long-Term Drift, ESD 4kV, Interfaces, Voltage Outputs, Part numbers
May 2022	4	2 / 4 / 6 / 15 / 18	Update of Humidity Response Time, Long-Term Drift, ESD 8kV, High T Storage, Bottom Pad, Thermal Resistance, Part numbers

[CLICK HERE >](#)
CONNECT WITH A SPECIALIST

NORTH AMERICA
Tel +1 800 522 6752

EUROPE
Tel +31 73 624 6999

ASIA
Tel +86 0400 820 6015

te.com/sensors

TE Connectivity, TE, TE Connectivity (logo) and Every Connection Counts are trademarks. All other logos, products and/or company names referred to herein might be trademarks of their respective owners

The information given herein, including drawings, illustrations and schematics which are intended for illustration purposes only, is believed to be reliable. However, TE Connectivity makes no warranties as to its accuracy or completeness and disclaims any liability in connection with its use. TE Connectivity's obligations shall only be as set forth in TE Connectivity's Standard Terms and Conditions of Sale for this product and in no case will TE Connectivity be liable for any incidental, indirect or consequential damages arising out of the sale, resale, use or misuse of the product. Users of TE Connectivity products should make their own evaluation to determine the suitability of each such product for the specific application.

© 2021 TE Connectivity Corporation. All Rights Reserved.

Version #4 05/2022

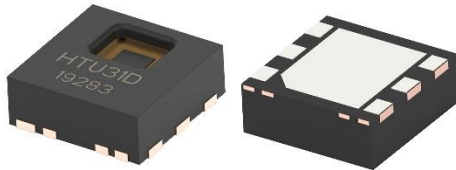

HTU31V RH/T SENSOR IC

Analog Relative Humidity & Temperature Sensor

Characteristics

- Fully calibrated, temperature compensated
- High accuracy: $\pm 2\%RH$ and $\pm 0.2^{\circ}C$
- Fast humidity response time: 3s
- Long term drift: $< 0.1\%RH/year$
- Wide supply voltage range from 3V to 5.5V
- Low average current: 161 μA typical
- Compact 6-Pin DFN package: 2.5x2.5x0.9mm
- Ratiometric voltage output
- Fully RoHS and REACH compliant

Features

- High Reliability and Robustness
- Fast Recovery after Saturation
- Fully Compatible with Reflow Process
- Fully Interchangeable without Calibration
- Serial Individual Marking for Traceability
- Lead Free
- Low Power Consumption

Applications

- Home Appliance
- HVAC
- Medical Respirators CPAP and Ventilators
- Industrial Transport / Cold Chain
- Humidifiers / Dehumidifier
- Meteorology
- Environmental Monitoring & Trackers
- IoT Applications
- IP Camera
- Water Leak Detector

General Description

The HTU31 is one of the smallest and most accurate humidity sensors on the market. TE Connectivity precision engineering and 20+ years of experience in humidity and temperature combination sensors, enabled this new product with fast response time, precision measurement, low hysteresis, robustness to reflow assembly process and sustained performance even when exposed to extreme temperature [-40° to $125^{\circ}C$] and humidity [0%RH to 100%RH] environments.

HTU31 humidity & temperature sensor includes both digital (D) and analog (V) versions and combines multiple functions with an application-friendly operating supply voltage range from 3V to 5.5V.

HTU31 sensor is available in small and large volumes to meet the ever-changing demands of our customers.

[CLICK HERE >](#)
CONNECT WITH A SPECIALIST

PERFORMANCE SPECIFICATIONS

Relative Humidity Specifications

 $V_{dd} = 5V$ 25°C

Characteristics	Condition	Value	Units	Notes / Conditions
Humidity Operating Range	Max ¹	0 to 100	%RH	
Relative Humidity Accuracy	Typical	±2	%RH	Figure 1 Humidity Sensor Rating @25°C
Resolution	Typical	0.01	%RH	
Hysteresis	@25°C	±0.7	%RH	
Response Time ²	$\tau_{63\%}$	3	s	
Recovery Time after Condensation ³	$\tau_{100\%}$	10	s	
Long Term Drift ⁴	Typical	<0.1	%RH / year	

Table 1 Humidity Specifications

Temperature Specifications

 $V_{dd} = 5V$ 25°C

Characteristics	Condition	Value	Units	Notes / Conditions
Temperature Operating Range		-40 to 125	°C	
Temperature Accuracy	Typical	±0.2	°C	Figure 2 Temperature Sensor Rating
Resolution	Typical	0.016	°C	
Response Time ²	$\tau_{63\%}$	10	s	
Long Term Drift	Typical	0.04	°C / year	

Table 2 Temperature Specifications

¹ Cf. Figure 3 Humidity and Temperature Operating Range² With 1m.s⁻¹ air flow³ Measured according to AFNOR standard NFX 15-113, with 3 m.s⁻¹ air flow⁴ Typical application in regular environmental variation within optimum measurement range

HTU31V RH/T SENSOR IC

Analog Relative Humidity & Temperature Sensor

Humidity Sensor Rating

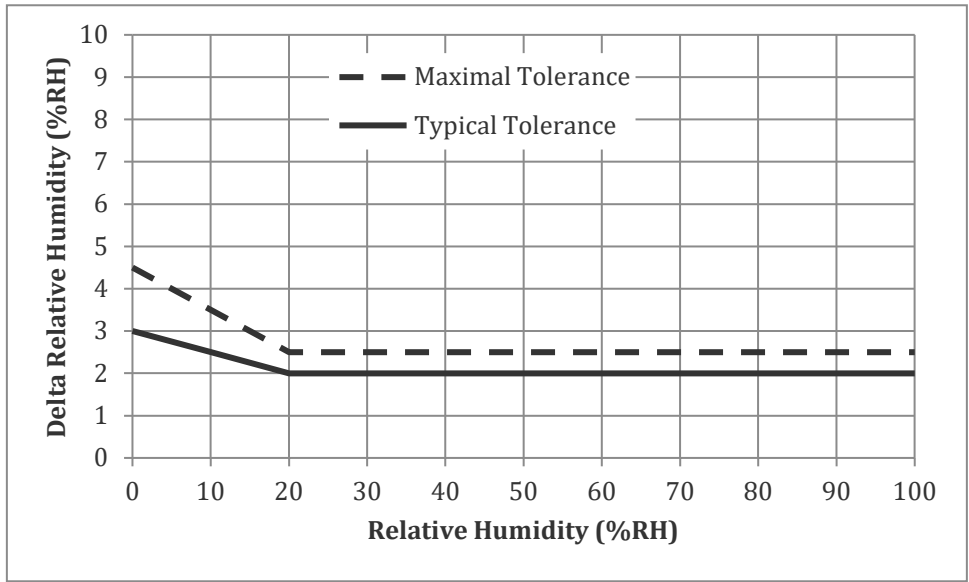

Figure 1 Humidity Sensor Rating @25°C

Temperature Sensor Rating

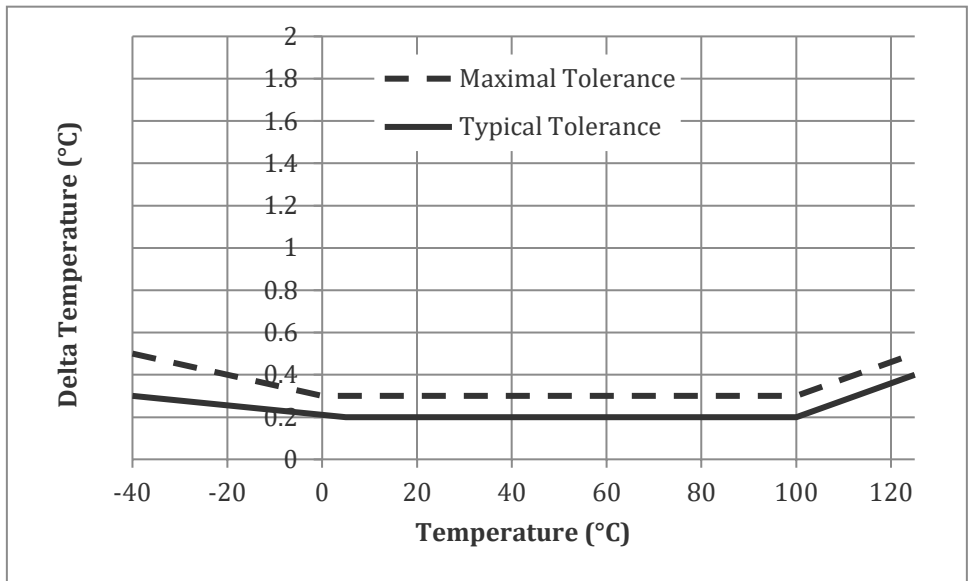

Figure 2 Temperature Sensor Rating

SENSOR INTEGRATION

Absolute Maximum Operating Conditions

Ratings	Symbol	Value	Unit	Notes / Conditions
Storage Temperature ⁵	Tstg	-40 to 200	°C	
Supply Voltage (Peak)	Vcc	5.5	Vdc	
Humidity Operating Range	RH	0 to 100	%RH	
Temperature Operating Range	Ta	-40 to +125	°C	
VDD to GND		-0.3 to 5.5	V	
ESD HBM (Human Body Model) ⁶		±8	kV	
ESD CDM (Charged Device Model) ⁷		750	V	
Latch Up Sensitivity ⁸		±300	mA	

Table 3 Maximum Operating Conditions

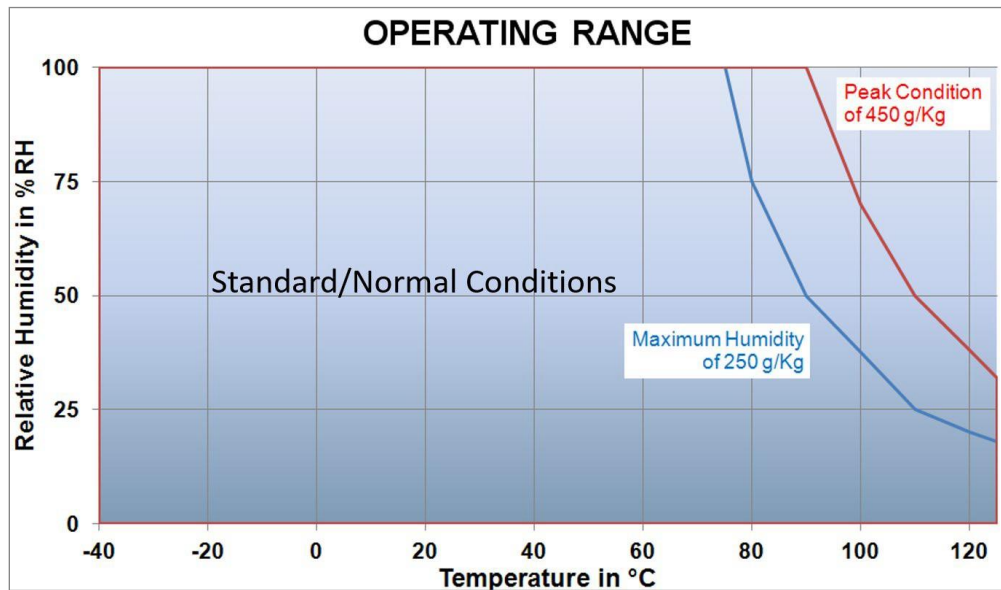

Figure 3 Humidity and Temperature Operating Range

The sensor should operate at peak condition less than 10% of the operating life. Exposure to absolute maximum humidity/temperature conditions for extended periods may temporarily induce an offset on RH measurement (+5%RH above accuracy specifications, which will recover over time) and accelerate its ageing.

⁵ Sensor in specifications after 1000h storage @125°C; No failure after 1000h storage @200°C

⁶ According to ANSI/ESDA/JEDEC JS-001-2017, AEC-Q100-002.

⁷ According to JESD22-C101, AEC-Q100-011

⁸ According to JESD78

HTU31V RH/T SENSOR IC

Analog Relative Humidity & Temperature Sensor

Electrical Specifications

$V_{dd} = 5V$ 25°C

Characteristics	Symbol	Min	Typ	Max	Unit	Notes / Conditions
Supply Voltage	V_{dd}	3.0	5.0	5.5	V	
Current Consumption	i_{dd}		161		μA	Typical
			511		μA	Peak
Power Dissipation			805		μW	Typical
			2.55		mW	Peak
Buffer Output Current				± 200	μA	
Buffer Capacitive Load		0.0		5.0	nF	

Table 4 Electrical Specifications

Timing Specifications

$V_{dd} = 5V$ 25°C

Characteristics	Symbol	Min	Typ	Max	Unit	Notes / Conditions
Power Up Time				10	ms	

Table 5 Timing Specifications

INTERFACES

Pin Assignment

N°	Function	Description
1	RH	RH Ratiometric Voltage Output
2	GND	Ground
3	BUF	Buffer Off Control
4	RST	Reset
5	VDD	Supply Voltage
6	TEMP	Temp. Ratiometric Voltage Output

TOP VIEW

BOTTOM VIEW

Table 6 Pin Assignment

Relative Humidity and Temperature Ratiometric Voltage Output Pins (RH / TEMP)

Relative humidity voltage output is directly provided via RH pin. Temperature voltage output is directly provided via TEMP pin.

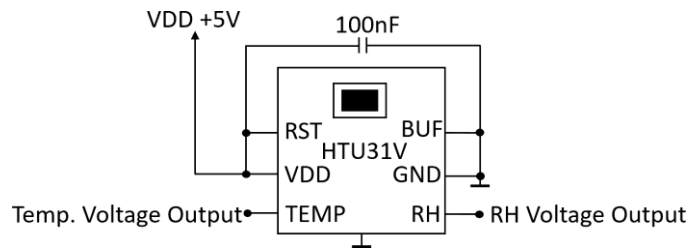

Figure 4 HTU31V Typical Application Circuit

Power Pins (VDD / GND)

Typical circuit includes a 100nF decoupling capacitor between VDD and GND, located as close as possible to the sensor. GND pin is internally connected to central pad. Depending on application electronic board thermal characteristics, soldering of this central pad may be recommended or not (cf. Thermal Resistance Information Page 10).

BUF Pin

The HTU31V includes a built-in output buffer for the two voltage RH and temperature outputs.

The BUF pin is used to enable or disable this output buffer.

- When BUF pin is connected to GND, as represented in *Figure 4 HTU31V Typical Application Circuit*, voltage output buffer is on, this is the recommended configuration for most applications.
- When BUF pin is connected to VDD, analog output buffer is off, the voltage outputs will be at high impedance, an external buffer is then highly recommended. Loading on RH and TEMP pins must be higher than 1GΩ to avoid nonlinear effects.

RST Pin

The RST pin can be used to generate a reset of the sensor. A minimum pulse of 1μs is required to reliably trigger a sensor reset.

- When RST pin is connected to GND, chip in reset / power down mode.
- When RST pin is connected to VDD, chip is in operating mode.

If reset feature is not used, RST pin must be connected to VDD, as represented in *Figure 4 HTU31V Typical Application Circuit*.

COMMUNICATION AND OPERATION

Conversion of Ratiometric Voltage Outputs

Relative Humidity Conversion

From the voltage output V_{RH} , updated each 250ms, the relative humidity in %RH is obtained by the following formula:

$$RH(\%) = -12,5 + 125 \cdot \frac{V_{RH}}{V_{DD}} = -\frac{10}{0,8} + \frac{100}{0,8} \cdot \frac{V_{RH}}{V_{DD}}$$

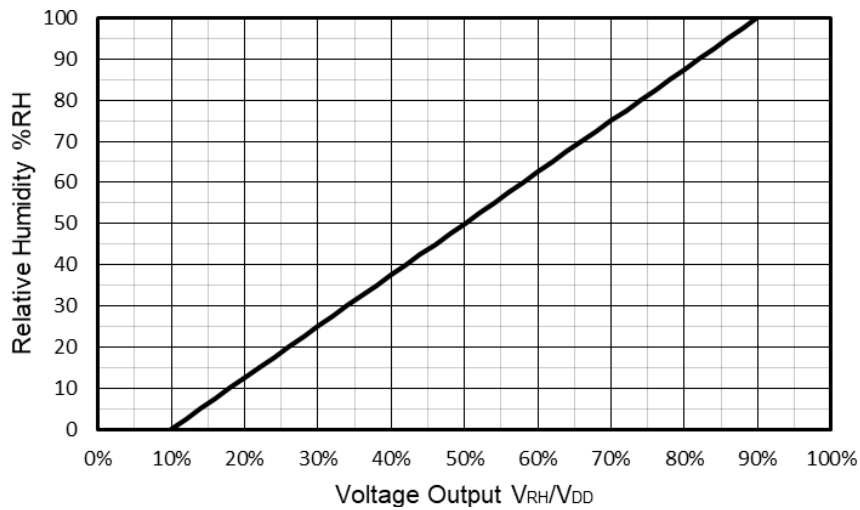

Figure 5 Relationship between ratiometric voltage output and measured relative humidity in %RH

Temperature Conversion

From the voltage output V_T , updated each 250ms, the temperature T in °C or in °F is obtained by the following formulas:

$$T(^{\circ}C) = -60,625 + 206,25 \cdot \frac{V_T}{V_{DD}} = -40 - \frac{16,5}{0,8} + \frac{165}{0,8} \cdot \frac{V_T}{V_{DD}}$$

$$T(^{\circ}F) = -77,125 + 371,25 \cdot \frac{V_T}{V_{DD}} = -40 - \frac{29,7}{0,8} + \frac{297}{0,8} \cdot \frac{V_T}{V_{DD}}$$

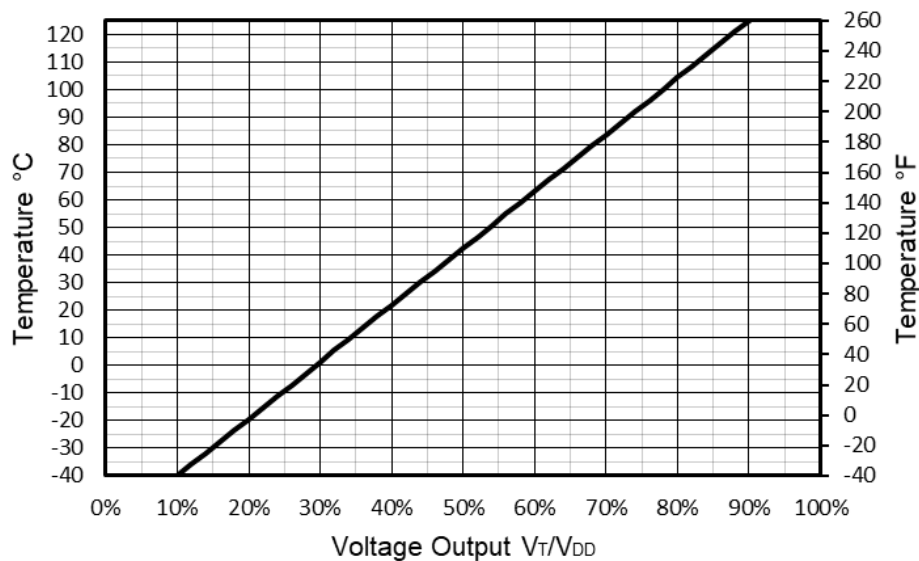

Figure 6 Relationship between ratiometric voltage output and measured temperature in °C and °F

HTU31V RH/T SENSOR IC

Analog Relative Humidity & Temperature Sensor

Error Codes

Relative Humidity

In case of abnormal open circuit, the voltage output V_{RH} will provide an error code : $V_{RH}=0V$.

In case of abnormal short circuit, the voltage output V_{RH} will provide an error code : $V_{RH}=V_{DD}$.

Temperature

In case of abnormal open circuit or values below $-50^{\circ}C$, the voltage output V_T will provide an error code : $V_T=0V$.

In case of values between $-50^{\circ}C$ and $-40^{\circ}C$, the voltage output V_T will provide a clamping : $V_T = \frac{V_T}{V_{DD}} = 10\%$.

In case of values between $125^{\circ}C$ and $150^{\circ}C$, the voltage output V_T will provide a clamping : $V_T = \frac{V_T}{V_{DD}} = 90\%$.

In case of abnormal short circuit or values above $150^{\circ}C$, the voltage output V_T will provide an error code : $V_T=V_{DD}$.

Dew Point Temperature Calculation

The dew point is the temperature at which the water vapor in the air becomes saturated and condensation begins.

The dew point is associated with relative humidity. A high relative humidity indicates that the dew point is closer to the current air temperature. Relative humidity of 100% indicates that the dew point is equal to the current temperature (and the air is maximally saturated with water). When the dew point stays constant and temperature increases, relative humidity will decrease.

Partial Pressure (PP_{Tamb}) Calculation from Ambient Temperature

Partial Pressure (PP_{Tamb}) is calculated using temperature measurement from HTU31 sensor with the following formula:

$$PP_{Tamb} = 10^{\left[A - \frac{B}{(T_{amb} + C)} \right]}$$

PP_{Tamb} Partial Pressure in mmHg at Ambient Temperature

T_{amb} Ambient Temperature in $^{\circ}C$, from HTU31

A, B, C Constants: A=8.1332; B=1762.39; C=235.66

Dew Point Temperature (T_d) Calculation from Partial Pressure (PP_{Tamb})

Dew point temperature (T_d) of the air is calculated using ambient relative humidity and temperature measurements from HTU31 sensor with the following formula:

$$T_d = \left[\frac{B}{\log_{10} \left(RH_{amb} \times \frac{PP_{Tamb}}{100} \right) - A} + C \right]$$

PP_{Tamb} Partial Pressure in mmHg at Ambient Temperature

RH_{amb} Ambient Relative Humidity in %RH, from HTU31

T_{amb} Ambient Temperature in $^{\circ}C$, from HTU31

T_d Calculated Dew Point in $^{\circ}C$

A, B, C Constants: A=8.1332; B=1762.39; C=235.66

PACKAGING AND ASSEMBLY INFORMATION

Package Outline

Bottom View

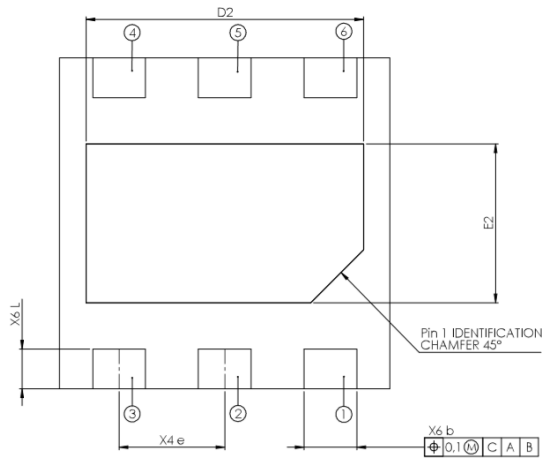

Side View

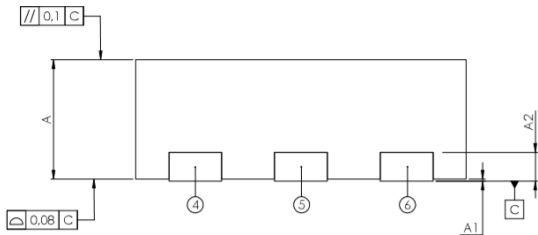

Description	"W" in the marking
HTU31 Digital	D
HTU31 Analog	V

Top View

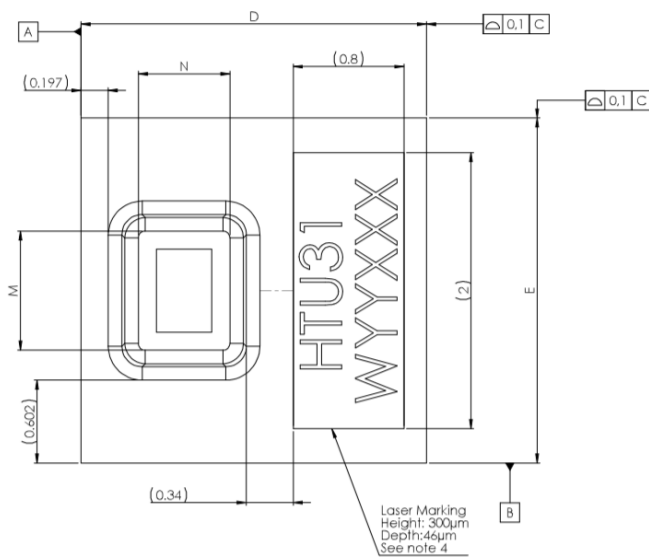

SYMBOL	COMMON					
	DIMENSIONS MILLIMETER			DIMENSIONS INCH		
	MIN.	NOM.	MAX.	MIN.	NOM.	MAX.
A	0.85	0.90	0.95	0.033	0.035	0.037
A1	0.00	0.02	0.05	0.000	0.001	0.002
A2	0.203 REF			0.008 REF		
b	0.35	0.40	0.45	0.014	0.016	0.018
D	2.45	2.50	2.55	0.096	0.098	0.100
D2	2.05	2.10	2.15	0.081	0.083	0.085
E	2.45	2.50	2.55	0.096	0.098	0.100
E2	1.15	1.20	1.25	0.045	0.047	0.049
e	0.80 BSC			0.031 BSC		
L	0.25	0.30	0.35	0.010	0.012	0.014
M	0.860 REF			0.034 REF		
N	0.660 REF			0.026 REF		

HTU31V RH/T SENSOR IC

Analog Relative Humidity & Temperature Sensor

Packaging Type

HTU31 is provided in DFN type package (Dual Flat No leads).
HTU31 sensor chip is mounted on a Cu and plated with Ni/Pd/Au lead frame.

Traceability Information

Sensor Marking

Each HTU31V sensor is laser marked with an alphanumeric code (cf. Top view Page 9). The marking, engraved on two lines, contains following information:

- The first line denotes the sensor type: HTU31.
- The second line noted WYYXXX denotes Output mode and Date Code:
 - **W** refers to Output mode: D = Digital (I²C) Output; V = Voltage Analog Output
 - **YY** digits defines the manufacturing year: 21=2021, 22=2022.
 - **XXX** refers to the day number.

Reel package Marking

Reels are also labeled for lot identification and additional traceability information, as shown below:



The reel label includes:

- Part Number
- Individual Lot Number (3X stands for HTU31, V for Voltage Output, Individual Lot Number)
- Quantity
- Date Code

Thermal Resistance Information

Characteristics	Symbol	Value	Unit
Junction-to-Ambient Thermal Resistance	θ_{JA}	55	°C/W
Junction-to-Board Thermal Resistance	θ_{JB}	16	°C/W
Junction-to-Case Thermal Resistance	θ_{JC}	3	°C/W
Junction-to-Top Characterization Parameter	ψ_{JT}	2	°C/W

Table 7 Thermal Resistance Values

Values are based on simulations and are offered for general reference use.

Depending on application electronic board thermal characteristics, soldering of central pad may be recommended or not.
In case of application electronic board (excluding HTU31) low self-heating, soldering of central pad is recommended.
In case of application electronic board (excluding HTU31) high self-heating, soldering of central pad may not be recommended.

HTU31V RH/T SENSOR IC

Analog Relative Humidity & Temperature Sensor

Tape & Reel Packaging

HTU31V sensors are delivered in tape & reel packaging, sealed into antistatic ESD bags.

Standard packaging sizes are 400, 1500 and 5000 units per reel.

Each reel contains 440mm (55 pockets) header tape and 200mm (25 pockets) trailer tape.

For 400 and 1500 units: outside diameter of 7" (178mm) and a 1/2" (13mm) diameter arbor hole.

For 5000 units: outside diameter of 13" (330mm) and a 1/2" (13mm) diameter arbor hole.

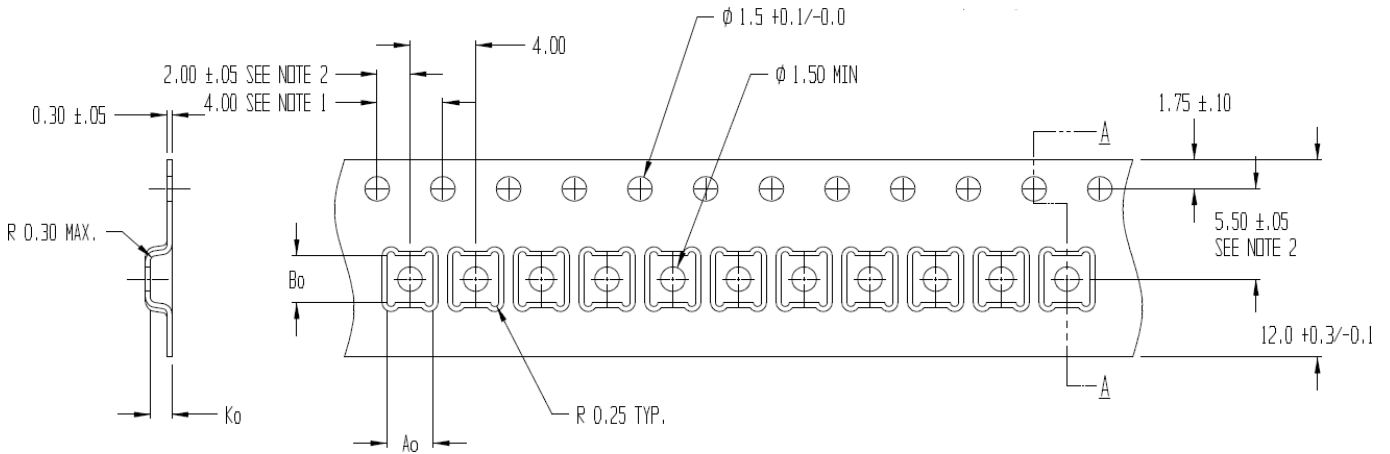

Figure 7 Tape and Reel Drawing

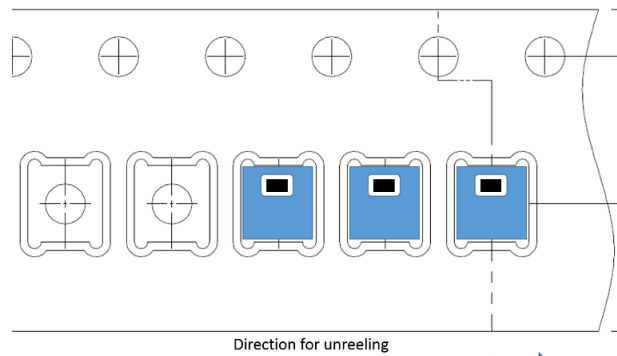

Figure 8 Product Orientation in Tape and Reel Packaging

Recommended Footprint for PCBa Assembly

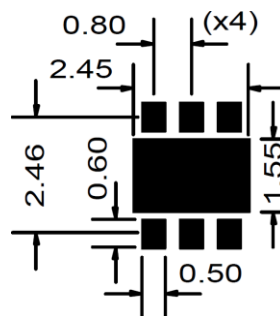

Figure 9 Recommended footprint (All dimensions are in mm)

HTU31V RH/T SENSOR IC

Analog Relative Humidity & Temperature Sensor

Handling & Storage Recommendations

To guaranty and preserve the high-quality performance of the HTU31 sensor, the following recommendations shall be respected concerning storage and packaging:

Prior sensors use or assembly, it is recommended to store them in their original sealed anti ESD packaging. If sensors have been removed from their original packaging, it is recommended to keep them in anti-static shielded ESD bags.

HTU31 sensor shall not be in contact with volatile chemicals such as solvents or other organic compounds that could induce a sensing element pollution or damage.

HTU31 sensor is classified MSL level 1 according to IPC/JEDEC J-STD-020.1 for storage, packaging and handling.

The typical shelf life is 1 year at temperature below 30°C and relative humidity below 85%RH.

HTU31 sensor shall be protected from ESD (Electrostatic Discharge) and shall be handled in ESD protected areas (EPA) under protected and standard controlled conditions (ground with wrist-straps, ground all non-insulating and conductive objects, operate only in grounded conductive floor).



Figure 10 Protection against ESD mandatory

Soldering and Assembly Instructions

HTU31 sensor is designed to withstand soldering profile according to IPC/JEDEC J-STD-020 with peak temperatures at 260°C during up to 30sec for Pb-free assembly in reflow ovens.

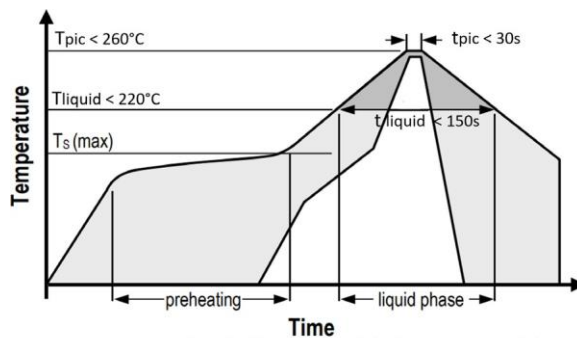

Figure 11 Reflow Soldering profile according to JEDEC standard

Standard pick & place equipment and vacuum nozzles for standard DFN packages may be used for assembly of HTU31 sensors.

For manual soldering contact time must be limited to 5 seconds at 350°C.

The use of “no clean” solder paste is recommended to avoid pollution or damage of RH sensing element.

In case of applications with exposure of the sensor to corrosive gases or condensed water (i.e. environments with high relative humidity) the soldering pads shall be sealed (e.g. conformal coating) to prevent loose contacts or short cuts.

No board wash shall be applied to HTU31 sensors without appropriate sensor upper surface adhesive tape protection.

No coating shall be applied to HTU31 sensors without appropriate sensor upper surface adhesive tape protection.

Immediately after soldering high thermal stress, HTU31 sensors may temporarily read a normal slight RH negative deviation (<1%RH) corresponding to sensing element extreme drying. This slight normal deviation will disappear after one or two days.

HTU31V RH/T SENSOR IC

Analog Relative Humidity & Temperature Sensor

ORDERING INFORMATION

Output Signal

D	I ² C Digital	Part Number HTU31x
V	Ratiometric Voltage	

Description	Quantity	Part number
HTU31D RH/T IC DIGITAL R400	400	10142048-20
HTU31D RH/T IC DIGITAL R1500	1500	10142048-21
HTU31D RH/T IC DIGITAL R5000	5000	10142048-22
HTU31V RH/T IC ANALOG R400	400	10142048-30
HTU31V RH/T IC ANALOG R1500	1500	10142048-31
HTU31V RH/T IC ANALOG R5000	5000	10142048-32
Demonstration Board HTU31D	1	10142605-10
Demonstration Board HTU31V	1	10142605-02

REVISION HISTORY

DATE	VERSION	PAGE(S)	CHANGES
January 2021	3	2 / 4 / 6 / 7 / 13	Update of Humidity Response Time, Long-Term Drift, ESD 4kV, Interfaces, Voltage Outputs, Part numbers
May 2022	4	2 / 4 / 6 / 10 / 13	Update of Humidity Response Time, Long-Term Drift, ESD 8kV, High T Storage, Bottom Pad, Thermal Resistance, Part numbers

[CLICK HERE >](#)
CONNECT WITH A SPECIALIST

NORTH AMERICA
Tel +1 800 522 6752

EUROPE
Tel +31 73 624 6999

ASIA
Tel +86 0400 820 6015

te.com/sensors

TE Connectivity, TE, TE Connectivity (logo) and Every Connection Counts are trademarks. All other logos, products and/or company names referred to herein might be trademarks of their respective owners

The information given herein, including drawings, illustrations and schematics which are intended for illustration purposes only, is believed to be reliable. However, TE Connectivity makes no warranties as to its accuracy or completeness and disclaims any liability in connection with its use. TE Connectivity's obligations shall only be as set forth in TE Connectivity's Standard Terms and Conditions of Sale for this product and in no case will TE Connectivity be liable for any incidental, indirect or consequential damages arising out of the sale, resale, use or misuse of the product. Users of TE Connectivity products should make their own evaluation to determine the suitability of each such product for the specific application.

© 2021 TE Connectivity Corporation. All Rights Reserved.

Version #4 05/2022

Looking for pricing, stock, or lifecycle information?

Click below to explore more details on WIN SOURCE:

 [View 10142048-22](#) on WIN SOURCE

 [TE Connectivity](#) Information

Optimize Your Supply Chain with WIN SOURCE Solutions

-  Global Sourcing Solution
-  Obsolete Management
-  Cost Control Management
-  Shortage Management
-  Alternative Solution
-  Excess Inventory Management