



**THE DATASHEET OF
10132797-013110LF**



BergStak® 0.5mm Mezzanine Connector

Expanded product range

RELIABLE SOLUTION FOR HIGH DENSITY APPLICATIONS

Amphenol's BergStak® 0.5mm is a comprehensive and versatile board-to-board solution designed for reliable and high-density applications. The unique design of scoop-proof housing ensures terminals are not damaged during mating.

- 0.5mm double row contact for high density connector
- Scoop-proof housing ensures terminals are not damaged during the mating
- PCB locator pegs option helps to ease manual assembly

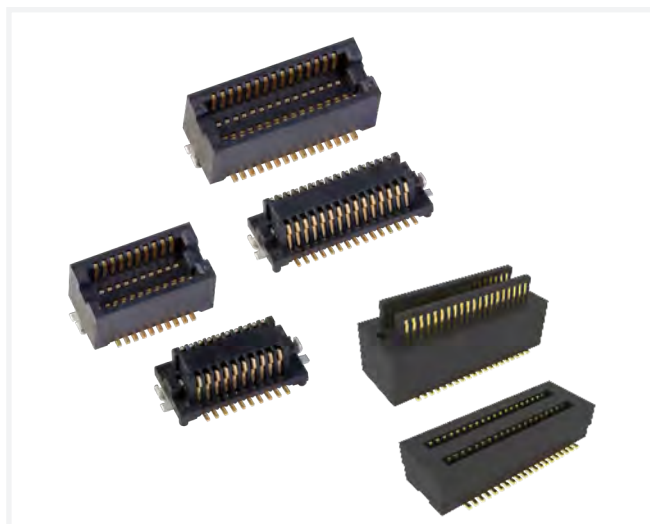

TARGET MARKETS



FEATURES

- 0.5mm double row contact
- Scoop-proof housings
- Metal hold-down option
- Locating pegs option
- 3mm to 6mm stack heights in 0.5mm increments
- 10 to 80 positions in 10 position increments
- 7mm to 8.5mm stack heights in 0.5mm increments
- 10 to 100 positions in 10 position increments
- Available in UL94 V0
- USCAR-2 V1 shock and vibration qualified
- RoHS compliant and lead-free

BENEFITS

- High density connector
- Ensures terminals are not damaged during mating
- Higher retention force
- Eases manual assembly
- Wide range of sizes and stack heights supports different applications
- High flammability rating
- Suitable for automotive applications
- Meets environmental, health, and safety requirements

TECHNICAL INFORMATION

MATERIAL

- Housing: High temperature thermoplastic UL94V-0, LCP, Black
- Terminal: Copper Alloy
- Metal Hold-down: Copper Alloy
- Plating: Gold Flash

MECHANICAL PERFORMANCE

- Mating Force: 1.47N per pin max.
- Unmating Force: 0.15N per pin min.
- Retention Force: 0.98N per pin min.
- Durability: 50 mating cycles
- Shock and Vibration: USCAR-2 V1

ELECTRICAL PERFORMANCE

- Current Rating per Contact: 0.5A per contact with all pins powered
- Insulation Resistance: 500M Ω min.
- Voltage Rating: 50VAC
- Speed: Up to 2Gb/s

ENVIRONMENTAL

- Salt Spray Test:
 - 5 \pm 1% salt concentration 48 \pm 4 hours 35 \pm 2 $^{\circ}$ C
- Thermal Shock: -65 $^{\circ}$ C to +125 $^{\circ}$ C
- High Temperature: 85 \pm 2 $^{\circ}$ C for 96 hours
- Humidity:
 - Temperature: 40 \pm 2 $^{\circ}$ C 96 hours
 - Relative Humidity: 90-95%
 - Duration: 96 Hours

SPECIFICATIONS

- 10132797/10132798: GS-12-1298
- 10165430/10165431: GS-12-1953

PACKAGING

- Tape & Reel

TARGET MARKETS/APPLICATIONS



Digital Video Camera



Measurement Equipment
Mobile Payment Device
Point of Sales Equipment
Portable Industrial Terminal
Surveillance Camera



Medical Device

PART NUMBERS – 3–6MM HEIGHT

PART NUMBER SELECTOR – HEADER

Find part number details using the search box on www.amphenol-cs.com

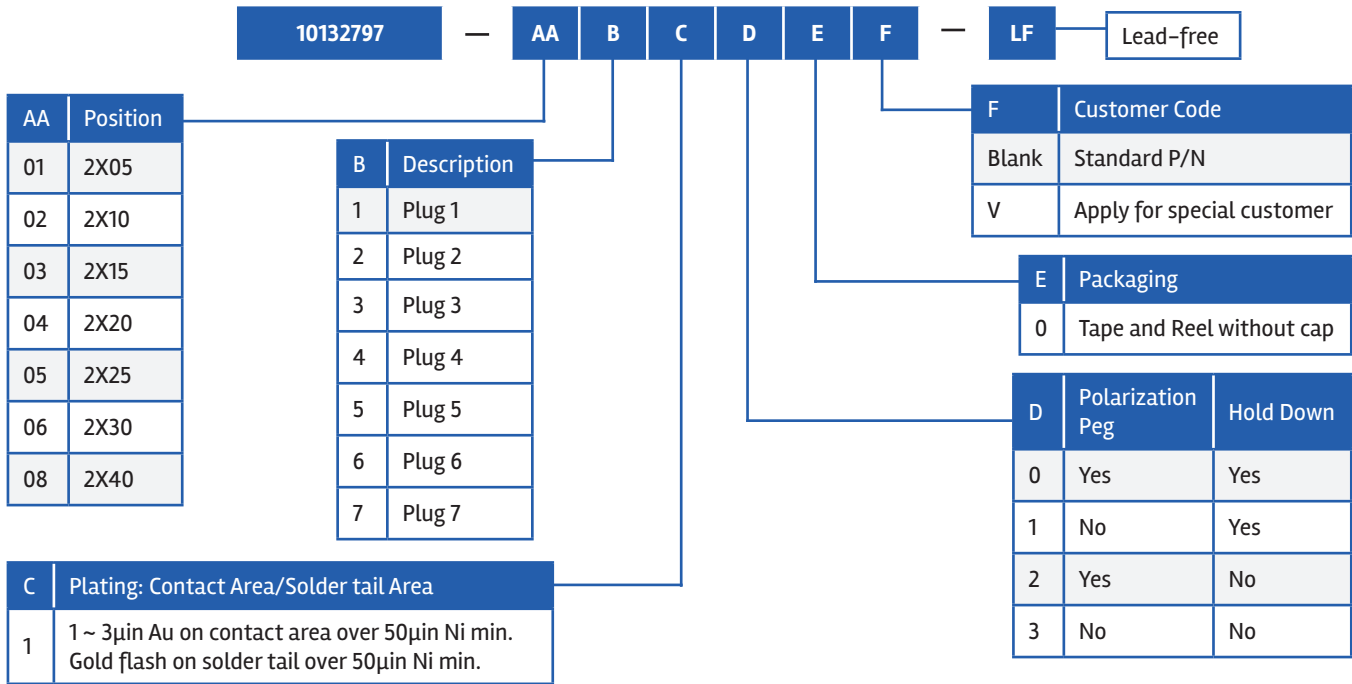





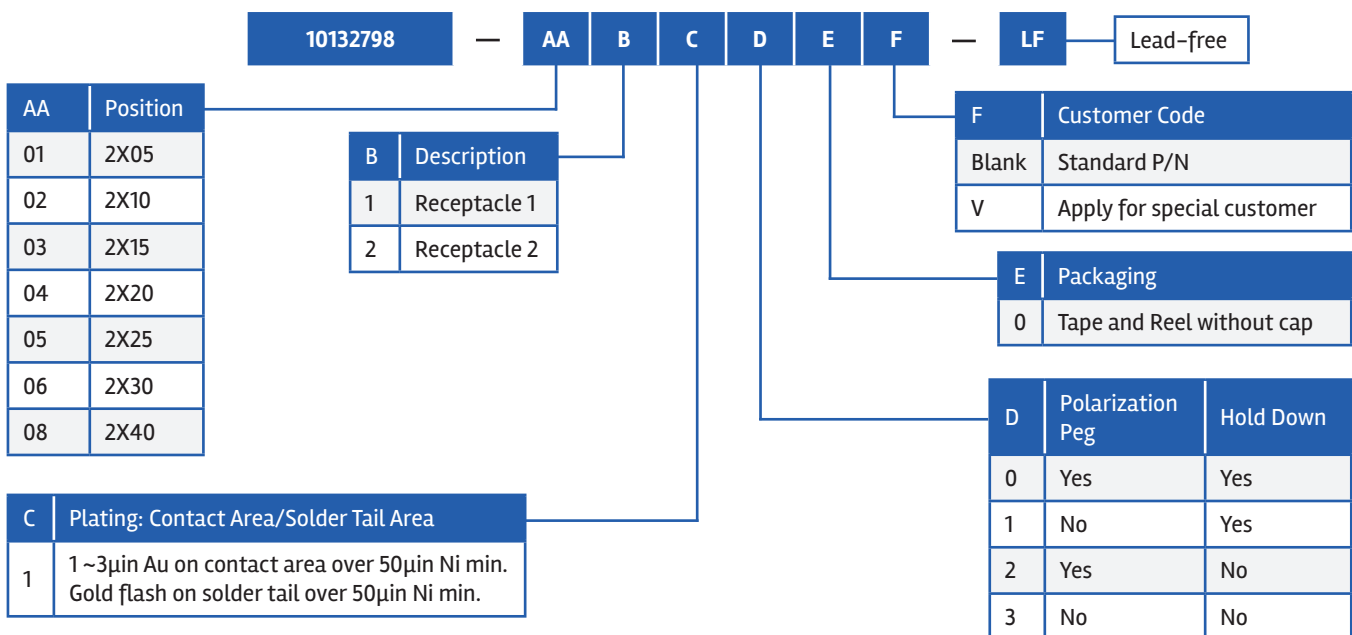



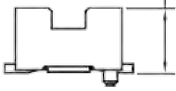



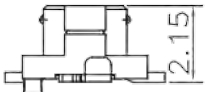
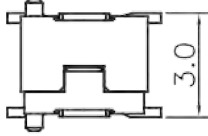

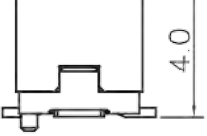
PART NUMBER SELECTOR – RECEPTACLE

Find part number details using the search box on www.amphenol-cs.com

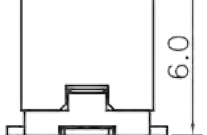

AVAILABLE STACK HEIGHTS

		10132797 SERIES (PLUG SERIES)			
10132798 SERIES (REC. SERIES)	COMBINATION OF MATED HEIGHT 3.0~4.5mm	Plug 1 	Plug 2 	Plug 3 	Plug 4 
	Recep 1 				
	COMBINATION OF MATED HEIGHT 5.0~6.0mm	Plug 5 	Plug 6 	Plug 7 	/
	Recep 2 				

PART NUMBERS – 7–8.5MM HEIGHT

PART NUMBER SELECTOR – HEADER

Find part number details using the search box on www.amphenol-cs.com

10165430 – X XXX X X – LF — Lead-free

Plug	Height
1	4.00mm

Contact	Plating
0	Gold flash

Pin	Number
010	2X5PIN
020	2X10PIN
...	
100	2X50PIN

Packaging	
0	Tape and Reel with cap

PART NUMBER SELECTOR – RECEPTACLE

Find part number details using the search box on www.amphenol-cs.com

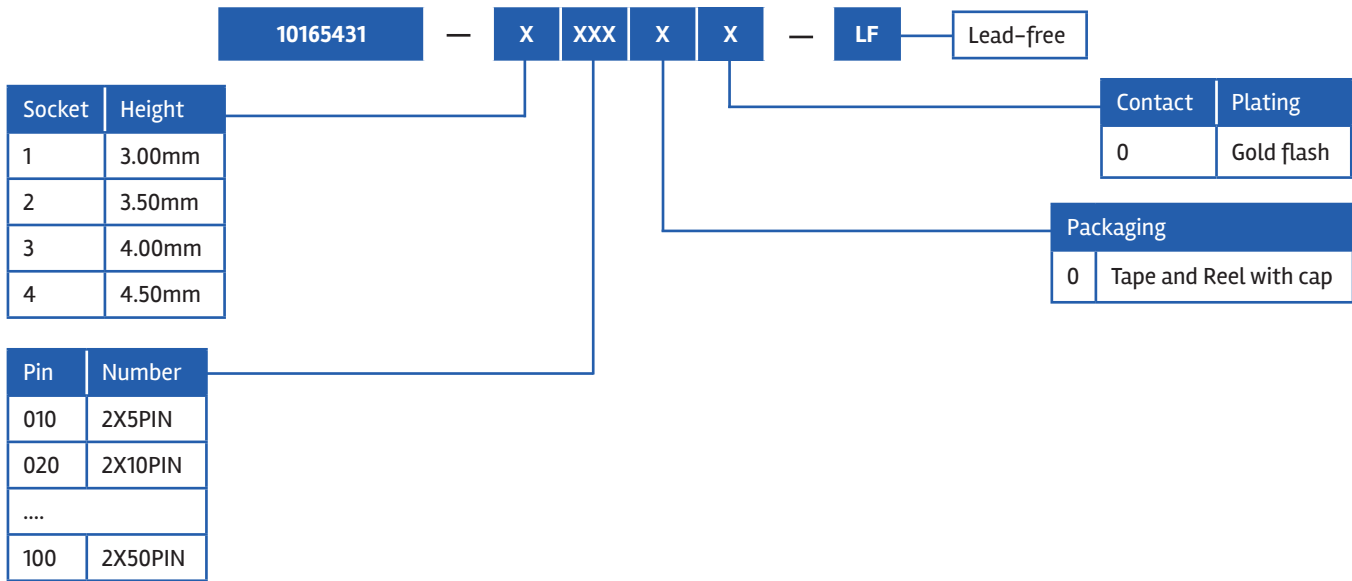

AVAILABLE STACK HEIGHTS

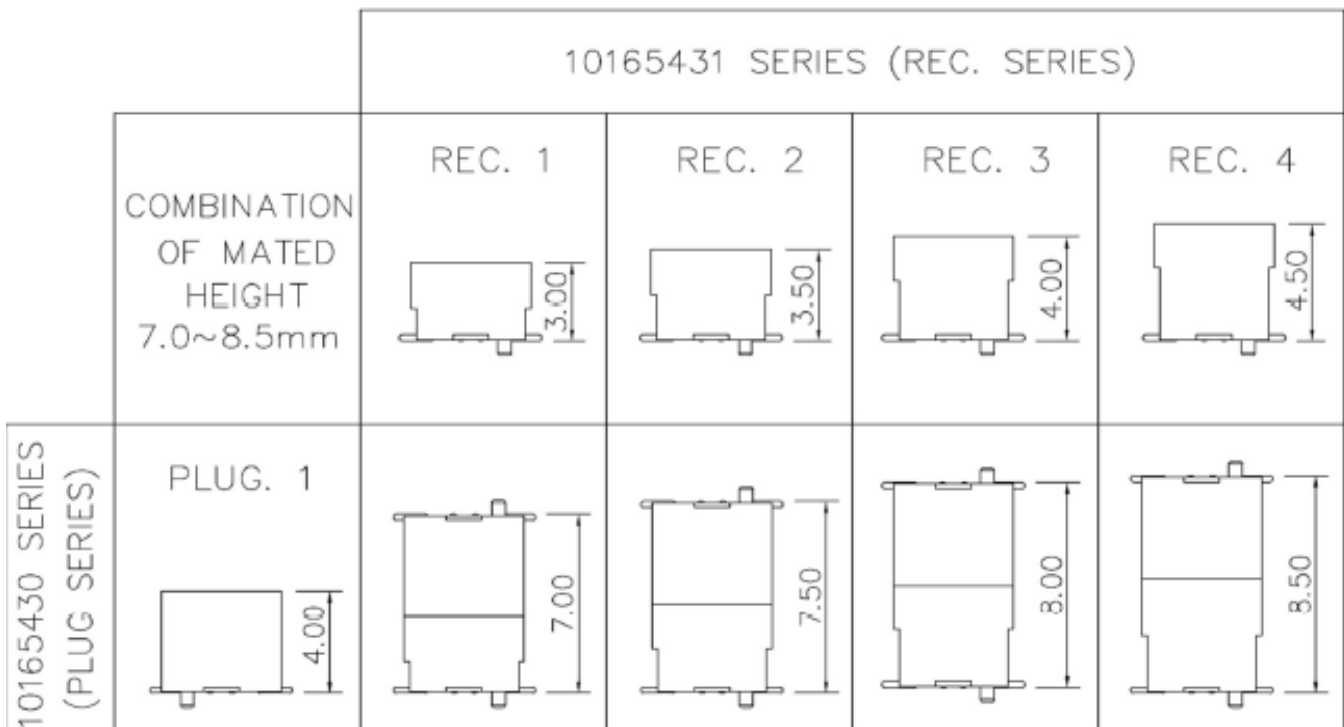

BWBBERG0524E44

Looking for pricing, stock, or lifecycle information?

Click below to explore more details on WIN SOURCE:

 [View 10132797-013110LF on WIN SOURCE](#)

 [Amphenol FCI Information](#)

Optimize Your Supply Chain with WIN SOURCE Solutions

-  Global Sourcing Solution
-  Obsolete Management
-  Cost Control Management
-  Shortage Management
-  Alternative Solution
-  Excess Inventory Management