

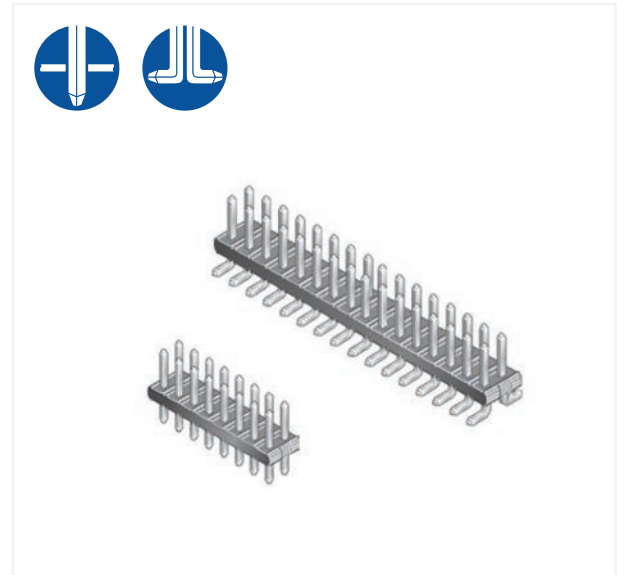

**THE DATASHEET OF  
10066848-103LF**



# MINITEK® UNSHROUDED VERTICAL HEADERS





## TECHNICAL INFORMATION

### MATERIALS

- Housing: High temperature, black thermoplastic
- Flammability rating: UL94V-0
- Pin: Phosphor-bronze
- Plating: Gold/GXT over 1.27µm (50µin.) nickel

### ELECTRICAL PERFORMANCE

- Current rating: 3A continuous
- Insulation resistance:  $1 \times 10^5 \text{M}\Omega$  min.
- Contact resistance: 25mΩ max.
- Dielectric withstanding voltage: 650V
- Voltage rating: 200V



### ENVIRONMENTAL PERFORMANCE

- Operating temperature range: -55°C to +125°C

### MECHANICAL PERFORMANCE

- Mating cycles (durability): 100

### SPECIFICATIONS

-  File no. E66906
-  File no. LR46923
- Product drawing: 57102 or 57202
- Product specification: DPS-12-011 and GS-12-163
- Tape and reel packaging data: TA-884

### APPROVALS AND CERTIFICATIONS

- This product is RoHS compatible according to the European Union Directive 2002/95/IEC

### PACKAGING

- Standard: TMT in tubes (04 to 06 pos. packed in box)
- SMT in Tape-and-reel
- Optional: SMT in tubes

### PROCESSING INFORMATION

- Compatible with wave, vapor-phase, and IR reflow soldering processes

## TYPICAL APPLICATIONS

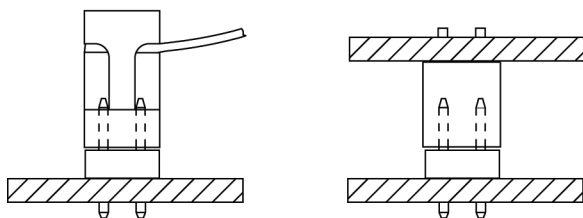
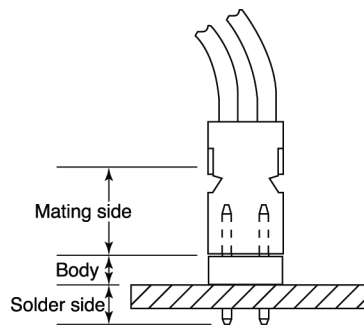

## PART NUMBERS

### CORE RANGE

57202 — G 52 — XXALF

XX = 02, 03, 04, 05, 06, 08, 10

5	7	LEAD	0	2	PLATING	PIN STYLE	POSITIONS PER ROW	PACKAGING	LF
Through Mount (TMT)		1						Through Mount (TMT)	02 to 25
Surface Mount (SMT)		2						Surface Mount (SMT)	02 to 25
0.76µm (30µin.), gold/GXT on mating area, 2-6µm (79-237µin.) tin on solder side					G				
Gold flash on mating area, 2-6µm (79-237µin.) tin on solder side					F				
							Tube without cap (TMT)	U	
							Tape-and-reel with cap (SMT)	A	

Surface Mount		Through Mount			
Mating Side (mm)	Pin Style	Mating Side (mm)	Solder Side (mm)	OAL (mm)	Pin Style
2.00	51	4.00	2.50	8.00	06
4.00	52	4.00	3.00	8.50	08

## PRODUCT



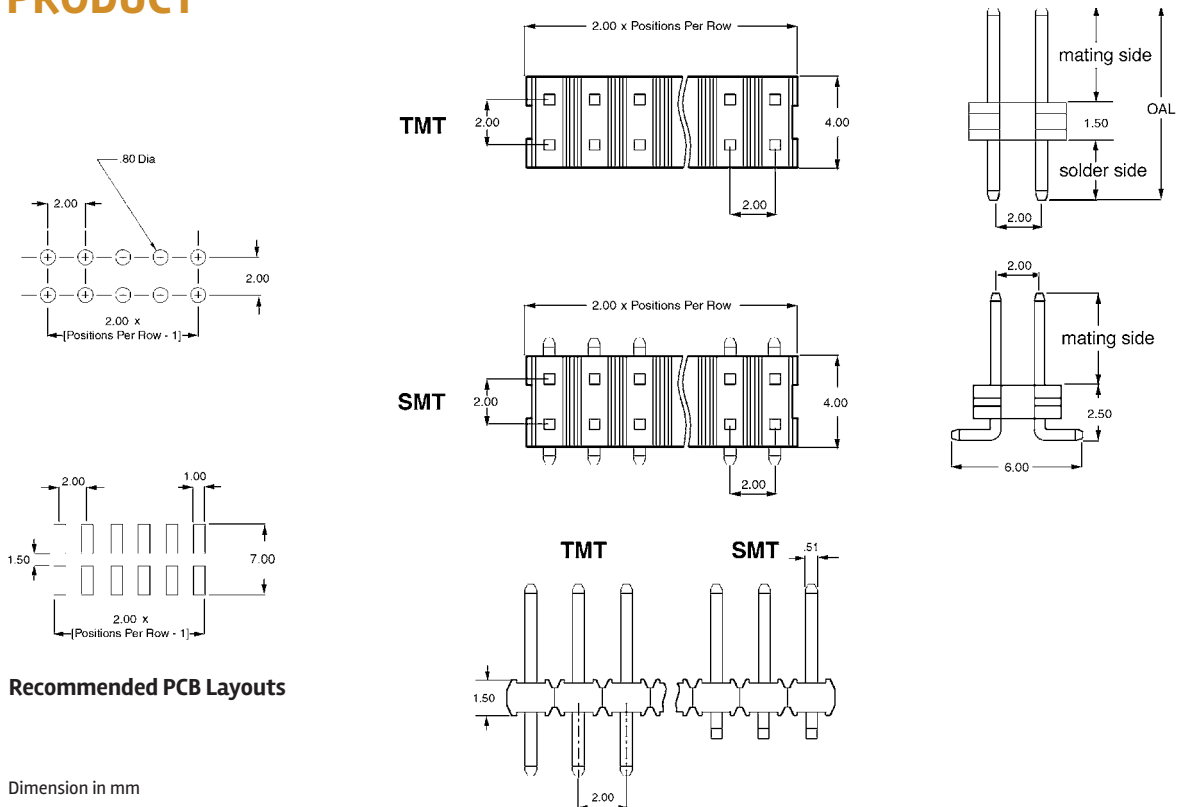

# MINITEK<sup>®</sup> UNSHROUDED RIGHT ANGLE HEADERS

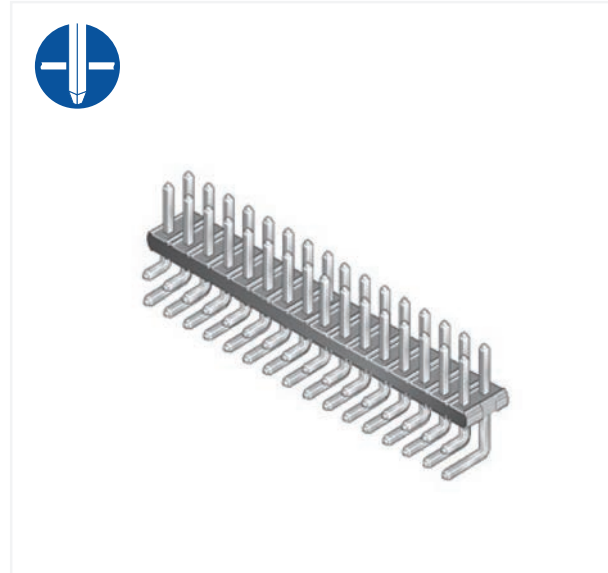

## FEATURES & BENEFITS

- High temperature plastic
- Selective plating



## **MINITEK® UNSHROUDED RIGHT ANGLE HEADERS**

### **TECHNICAL INFORMATION**

#### **MATERIALS**

- Housing: High temperature, black thermoplastic
- Flammability rating: UL94V-0
- Pin: Phosphor-bronze
- Plating: Gold/GXT over 1.27µm (50µin.) nickel

#### **ELECTRICAL PERFORMANCE**

- Current rating: 3A continuous
- Insulation resistance:  $1 \times 10^5 \text{M}\Omega$  min.
- Contact resistance: 25mΩ max.
- Dielectric withstanding voltage: 650V
- Voltage rating: 200V

#### **ENVIRONMENTAL**

- Operating temperature range: -55°C to +125°C



#### **MECHANICAL PERFORMANCE**

- Mating cycles (durability): 100

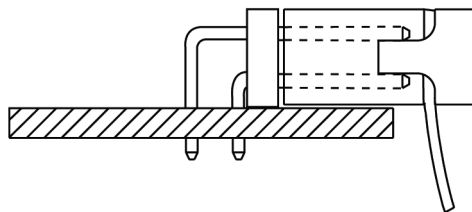
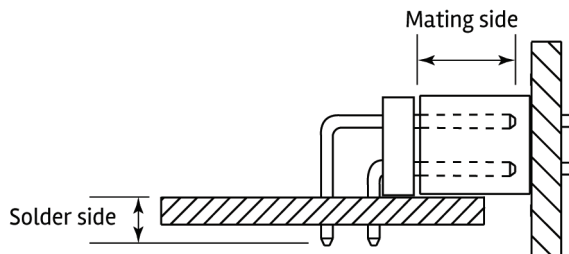
### **TYPICAL APPLICATIONS**



#### **SPECIFICATIONS**

-  File no. E66906
-  File no. LR46923
- Product drawing: 98423
- Product specification: DPS-12-011 and GS-12-163

#### **APPROVALS AND CERTIFICATIONS**

- This product is RoHS compatible according to the European Union Directive 2002/95/IEC

#### **PACKAGING**

- Tubes (04 to 06 pos. packed in box)

#### **PROCESSING INFORMATION**

- Compatible with wave, vapor-phase, and IR reflow soldering processes

**MINITEK® UNSHROUDED  
RIGHT ANGLE HEADERS**



**PART NUMBERS**



0.76µm (30µin.), gold/GXT on mating area, 2-6µm (79-237µin.) tin on solder side	G
Gold flash on mating area, 2-6µm (79-237µin.) tin on solder side	F

02 to 25

**PRODUCT**

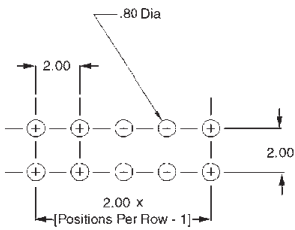

**Recommended PCB Layouts**

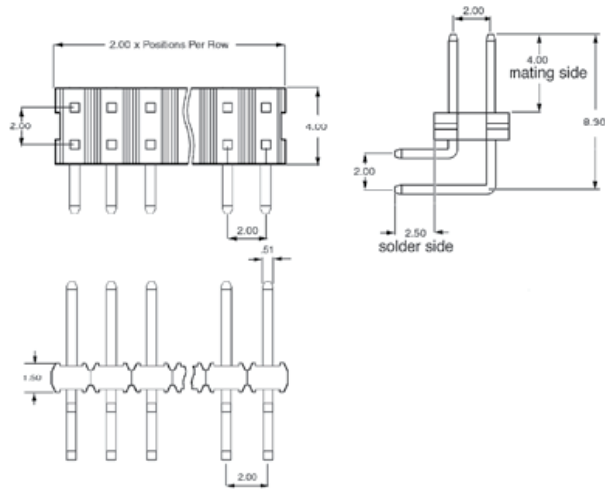

Dimension in mm

For more information,  
please contact: [Communications@fci.com](mailto:Communications@fci.com)  
or visit us at [www.fci.com](http://www.fci.com)

**Disclaimer**  
Please note that the above information is subject to change without notice.

# MINITEK® UNSHROUDED HEADERS, PIN-IN-PASTE

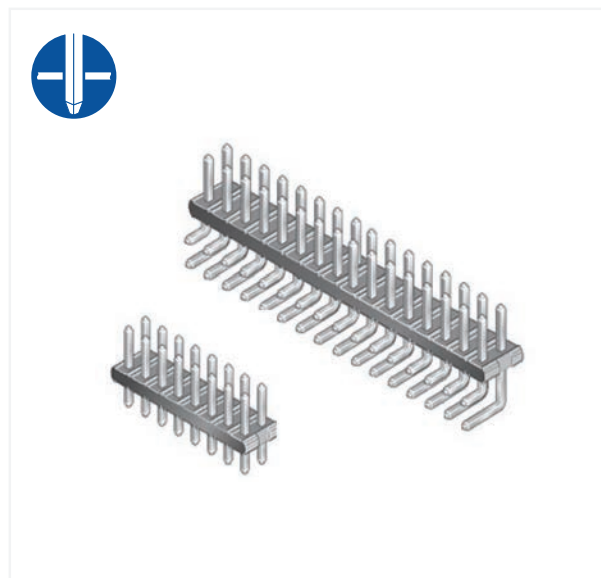

# MINITEK® UNSHROUDED HEADERS, PIN-IN-PASTE

## TECHNICAL INFORMATION

### MATERIALS

- Housing: High temperature, black thermoplastic
- Flammability rating: UL94V-0
- Pin: Phosphor-bronze
- Plating: Gold/GXT over 1.27µm (50µin.) nickel

### ELECTRICAL PERFORMANCE

- Current rating: 3A continuous
- Insulation resistance:  $1 \times 10^5 \text{M}\Omega$  min
- Contact resistance: 25Ω max.
- Dielectric withstanding voltage: 650V
- Voltage rating: 200V



### ENVIRONMENTAL

- Operating temperature range: -55°C to +125°C

### MECHANICAL PERFORMANCE

- Mating cycles (durability): 100

### SPECIFICATIONS

-  File no. E66906
-  File no. LR46923
- Product drawing: By 8-digit base part number
- Product specification: DPS-12-011 and GS-12-163
- Application specification: TA-895
- Reflow profile: TA-842

### PACKAGING

- Tubes (04 to 06 pos. packed in box)
- Tape-on-reel with pick up cap

### PROCESSING INFORMATION

- Compatible with wave, vapor-phase, and IR reflow soldering processes

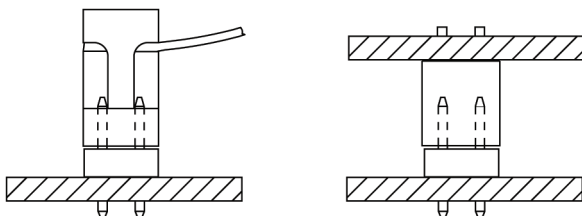
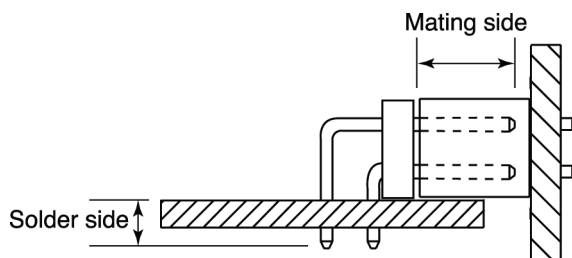

## PART NUMBERS

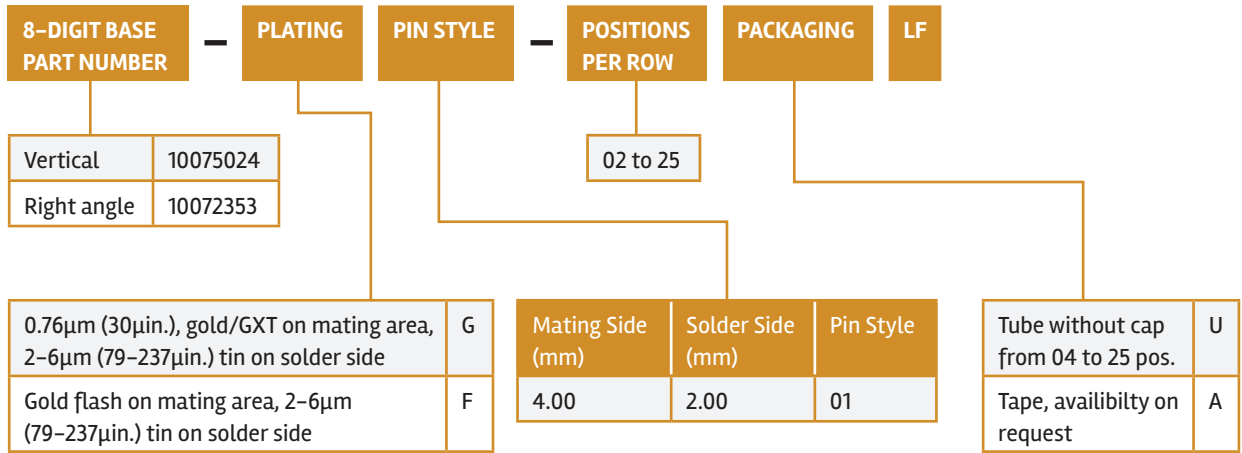

## PRODUCT

**10075024 Vertical**

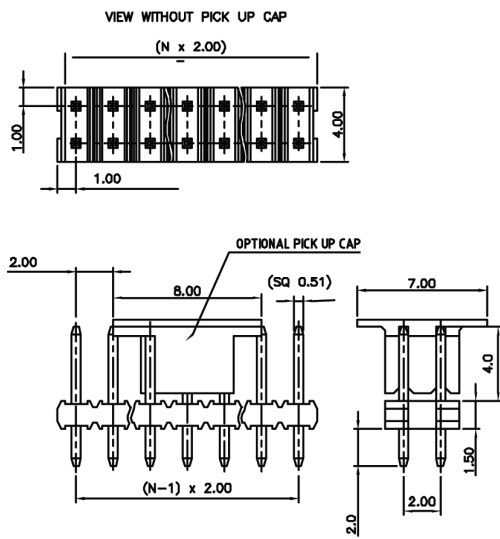

**10072353 Right angle**

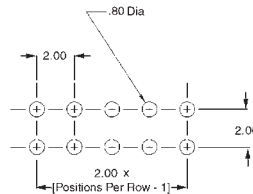
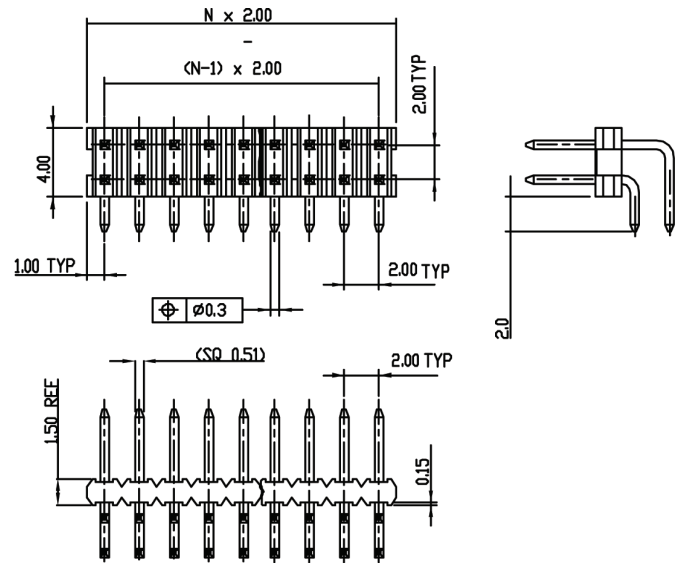

### Recommended PCB Layouts

Dimension in mm

# MINITEK® UNSHROUDED STACKING HEADERS

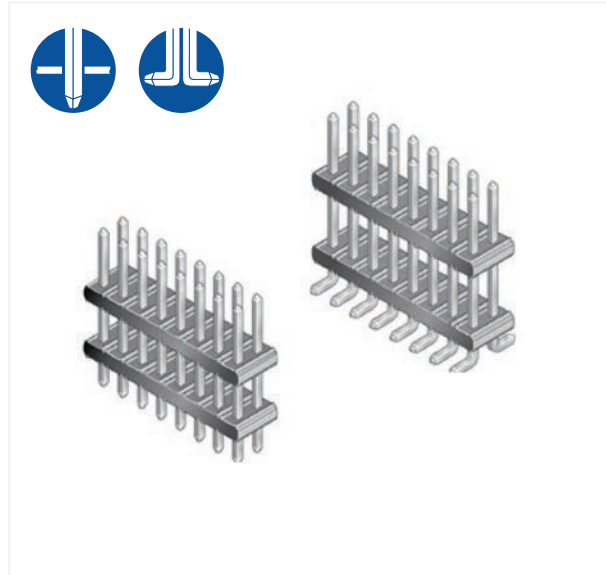

## FEATURES & BENEFITS

- Wide variety of stack heights in 0.13mm increments
- Custom sizes to meet your specific design requirements

## TECHNICAL INFORMATION

### MATERIALS

- Housing: High temperature, black thermoplastic
- Flammability rating: UL94V-0
- Pin: Phosphor-bronze
- Plating: Gold over 1.27µm (50µin.) nickel

### ELECTRICAL PERFORMANCE

- Current rating: 2A continuous
- Insulation resistance: 1 x 10<sup>5</sup>MΩ min.
- Contact resistance: 25Ωm max.
- Dielectric withstanding voltage: 650V
- Voltage rating: 200V



### ENVIRONMENTAL

- Operating temperature range: -55°C to +125°C

### MECHANICAL PERFORMANCE

- Mating cycles (durability): 100

### SPECIFICATIONS

-  File no. E66906
-  File no. LR46923
- Product drawing: 59112, 59132, or 59202
- Product specification: DPS-12-011

### APPROVALS AND CERTIFICATIONS

- This product is RoHS compatible according to the European Union Directive 2002/95/IEC

### PACKAGING

- Standard: In bags

### PROCESSING INFORMATION

- Compatible with wave, vapor-phase, and IR reflow soldering processes

## TYPICAL APPLICATIONS

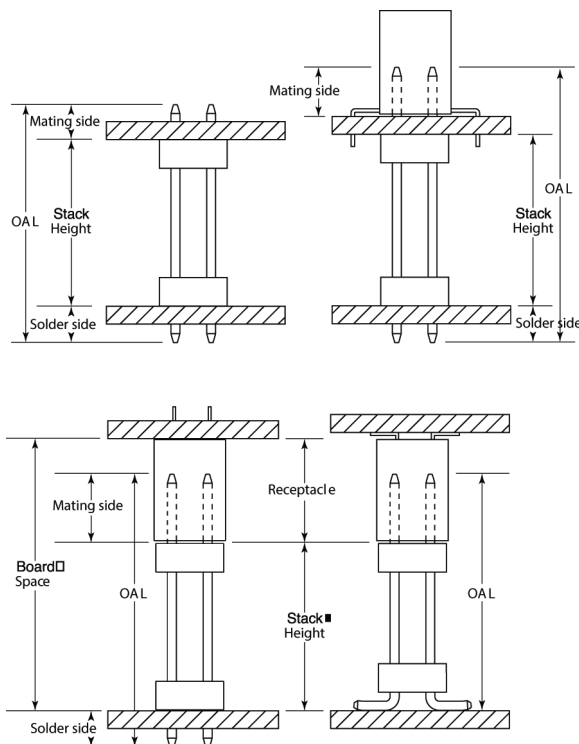

**MINITEK® UNSHROUDED STACKING HEADERS**

**PART NUMBERS**

Compile your own part number using custom dimensions (Please allow for initial setup on our system)

5	9	LEAD	SOLDER SIDE OPTION	2	PLATING	PIN STYLE	POSITIONS PER ROW	STACK HEIGHT	LF
---	---	------	--------------------	---	---------	-----------	-------------------	--------------	----

Through Mount (TMT)	1
Surface Mount (SMT)	2

2.50	1
3.00	3
SMT	0

0.76µm (30µin.) gold on mating side, tin on solder side	T
---	---

Overall Length (OAL)		Pin Style
(TMT) mm	(SMT) mm	
8.20	6.53	22
9.55	7.87	24
10.19	8.51	26
11.79	10.11	28
13.54	11.86	30
14.10	12.42	32
15.60	13.92	34
17.09	15.42	36
19.08	17.40	38
21.08	19.41	40

  

TMT	02 to 25
SMT	02 to 25

XXX = mm  
Specify mm (e.g., 037 = 03.7mm) in 0.1mm increments

**PRODUCT**

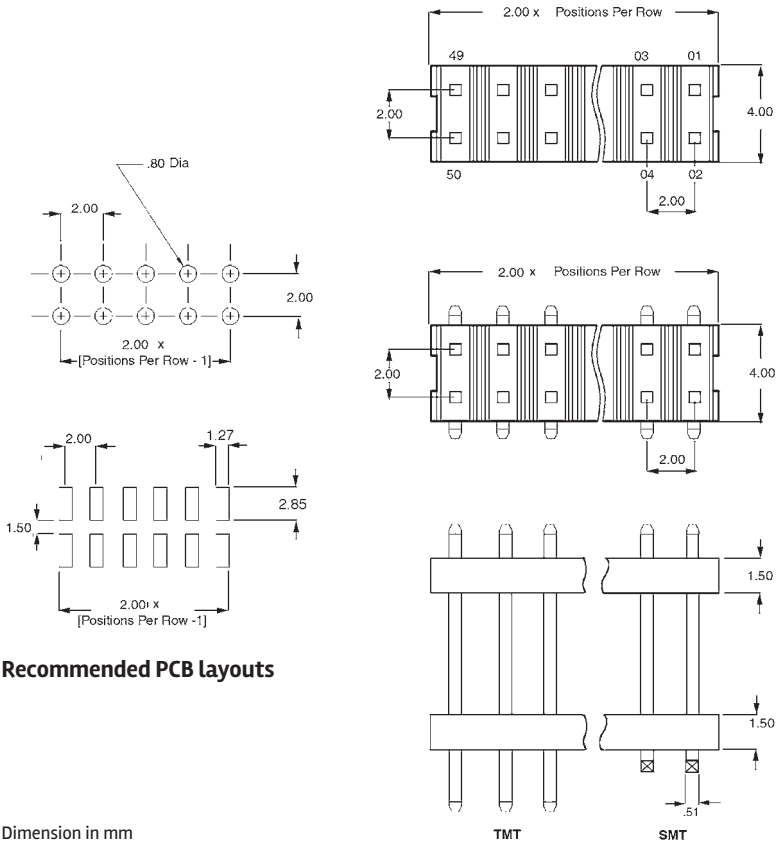

**The board spacing** is the stack height of this header, plus the height of the receptacle (see application drawings on opposite page)

**Recommended PCB layouts**

Dimension in mm

For more information, please contact: [Communications@fci.com](mailto:Communications@fci.com) or visit us at [www.fci.com](http://www.fci.com)

**Disclaimer**  
Please note that the above information is subject to change without notice.

## MINITEK® VERTICAL RECEPTACLES

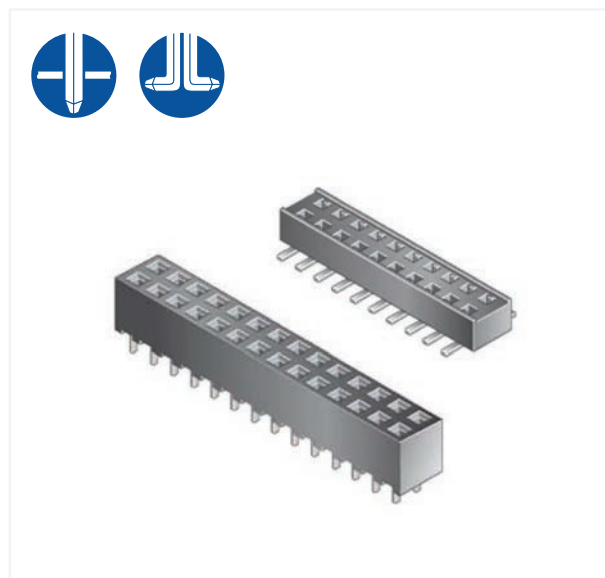

### FEATURES & BENEFITS

- Two housing heights: 2.30mm, 4.50mm
- Dual-beam contact design for highly reliable electrical performances



## TECHNICAL INFORMATION

### MATERIALS

- Housing: High temperature, black thermoplastic
- Flammability rating: UL94V-0
- Contact: Phosphor-bronze
  - Beryllium-copper-63453
- Plating: Gold over 1.27µm (50µin.) nickel

### ELECTRICAL PERFORMANCE

- Current rating: 2A continuous
- Insulation resistance: 1 x 10<sup>5</sup>MΩ min.
- Contact resistance:
  - 20mΩ
  - 25mΩ – 63453
- Dielectric withstanding voltage: 650V
- Voltage rating: 200V



### ENVIRONMENTAL

- Operating temperature range: -55°C to +125°C

### MECHANICAL PERFORMANCE

- Mating cycles (durability):
  - 25
  - 100 – 63453
- Contact retention to housing:
  - 2.20 N (227gf) min.
  - 4.90 N (500gf) min. – 63453
- Insertion force per contact:
  - 1.80 N (184gf) max.
  - 1.95 N (200gf) – 63453
- Withdrawal force per contact:
  - 0.20 N (20gf) min.

### SPECIFICATIONS

-  File no. E66906
-  File no. LR46923
- Product drawing: By 5-digit base part number
- Product specification:
  - GS-12-008
  - DPS-12-011 – for 63453

### APPROVALS AND CERTIFICATIONS

- This product is RoHS compatible according to the European Union Directive 2002/95/IEC

### PACKAGING

- Standard:
  - TMT in tubes
  - SMT in tape-and-reel
- Optional: Tubes (SMT)

### PROCESSING INFORMATION

- Compatible with wave, vapor-phase, and IR reflow soldering processes

### INSERTION DEPTH

- 4.50mm height: 3.00mm min. to 4.30mm max. [provides .381mm wipe]
- 2.30mm height – top entry: 1.30mm min. to 2.20mm max. [provides .381mm wipe]
- 2.30mm height – bottom entry: 1.40mm min. to 2.20mm max. [provides .381mm wipe] plus board thickness

## TYPICAL APPLICATIONS

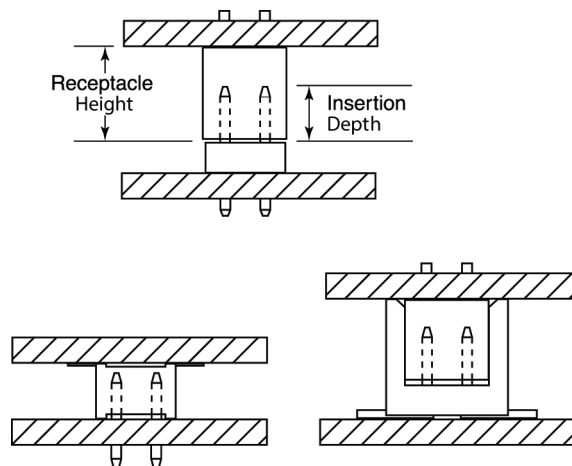

# PART NUMBERS

## CORE RANGE

55510 — 1XXTRLF

XX = 04, 06, 08, 10, 12, 16, 20

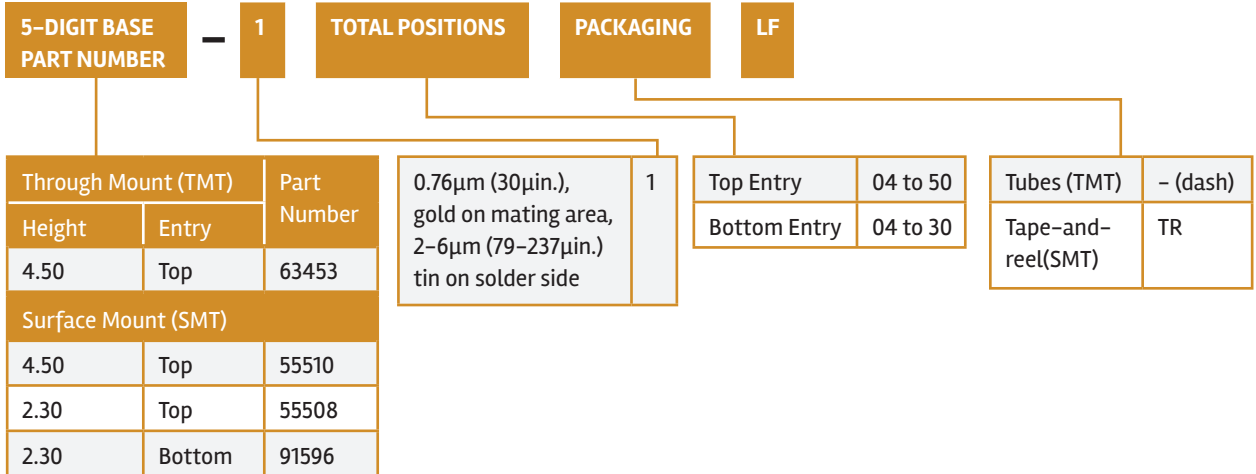

# PRODUCT

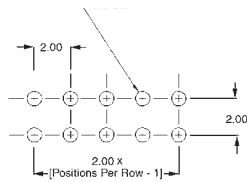

Top Entry

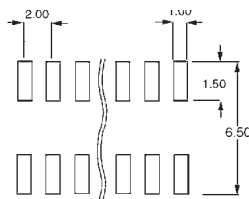

Bottom Entry

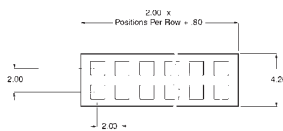
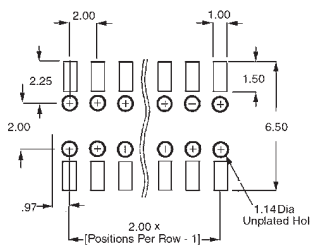

P/N 63453

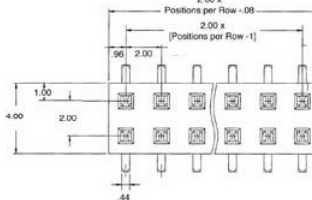
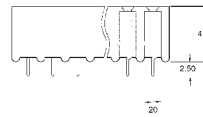

P/N 55510

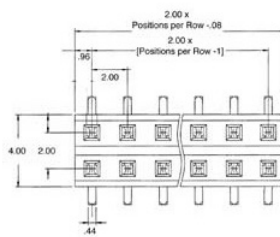
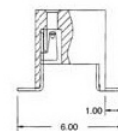
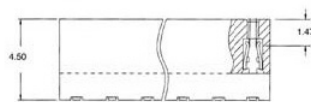

P/N 55508

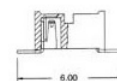

## Recommended PCB layouts

Dimension in mm

For more information,  
please contact: [Communications@fci.com](mailto:Communications@fci.com)  
or visit us at [www.fci.com](http://www.fci.com)

**Disclaimer**  
Please note that the above information is subject to change without notice.



# MINITEK® SHUNTS

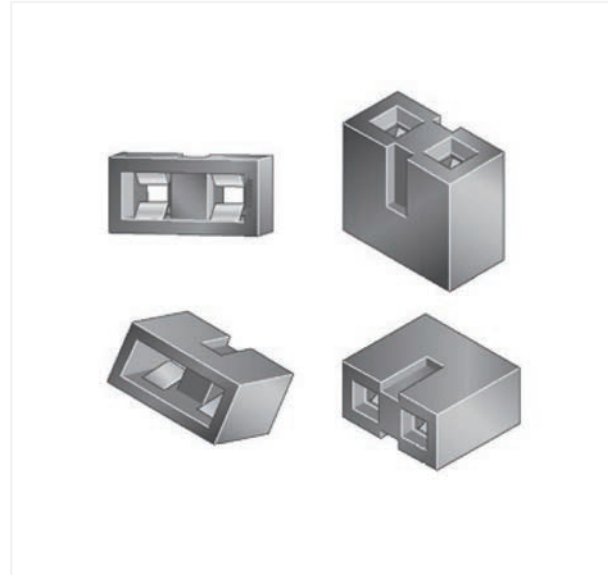

## FEATURES & BENEFITS

- Early entry, dual-beam contacts provide long wiping action for reliable electrical contact



## TECHNICAL INFORMATION

### MATERIALS

- Housing: High temperature, black thermoplastic
- Flammability rating: UL94V-0
- Contact: Phosphor-bronze
- Plating: Gold or tin over 1.27µm (50µin.) nickel

### ELECTRICAL PERFORMANCE

- Current rating: 1A continuous
- Insulation resistance: 1 x 10<sup>5</sup>MΩ min.
- Contact resistance: 25mΩ
- Dielectric withstanding voltage: 650V
- Voltage rating: 200V

### ENVIRONMENTAL

- Operating temperature range: -55°C to +125°C



### MECHANICAL PERFORMANCE

- Mating cycles (durability): 50
- Insertion force per contact: 6.41 N (650gf) max.
- Withdrawal force per contact: 0.49 N (50gf) min.

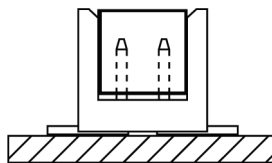
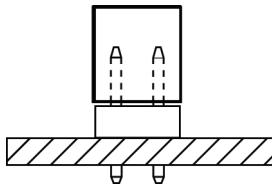
## TYPICAL APPLICATIONS



### SPECIFICATIONS

-  File no. E66906
-  File no. LR46923
- Product drawing: By 5-digit base part number
- Product specification: DPS-12-012

### APPROVALS AND CERTIFICATIONS

- This product is RoHS compatible according to the European Union Directive 2002/95/IEC

### PACKAGING

- Bags

### PROCESSING INFORMATION

- Compatible with wave, vapor-phase, and IR reflow soldering processes

### INSERTION DEPTH

- 2.24mm min. [provides .381mm wipe]



## PART NUMBERS

### CORE RANGE

86730 — 101LF

8 6 7 3 0 — PLATING 0 1 LF

0.76µm (30µin.) gold on mating area, 2-6µm (79-237µin.) tin on solder side	1
Gold flash	0

## PRODUCTS

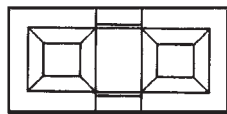
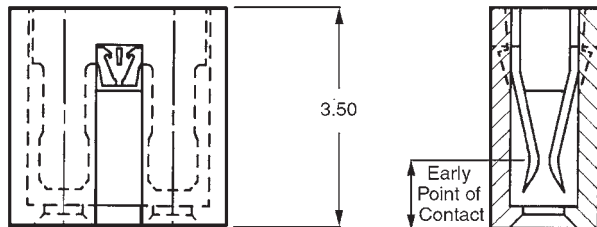
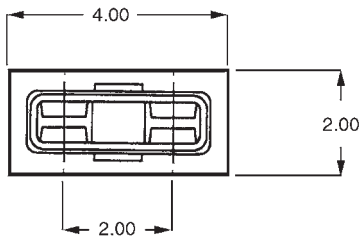

Dimension in mm

# MINITEK® SHROUDED VERTICAL HEADERS



## FEATURES & BENEFITS

- 4-wall design prevents mis-mating
- Selective plating
- Co-planarity 0.1 (SMT)



## TECHNICAL INFORMATION

### MATERIALS

- Housing: High temperature, cream-coloured thermoplastic
- Flammability rating: UL94V-0
- Pin: Phosphor-bronze
- Plating: Gold/GXT over 1.27µm (50µin.) nickel

### ELECTRICAL PERFORMANCE

- Current rating: 2A continuous
- Insulation resistance:  $1 \times 10^5 \text{M}\Omega$  min.
- Contact resistance: 25mΩ max.
- Dielectric withstanding voltage: 650V
- Voltage rating: 200V



### ENVIRONMENTAL

- Operating temperature range: -40°C to +125°C

### MECHANICAL PERFORMANCE

- Mating cycles (durability): 100

### SPECIFICATIONS

-  File no. E66906
-  File no. LR46923
- Product drawing: 98414 or 98424
- Product specification: DPS-12-011 and GS-12-163
- Tape and reel packaging data: TA-884

### APPROVALS AND CERTIFICATIONS

- This product is RoHS compatible according to the European Union Directive 2002/95/IEC

### PACKAGING

- Standard:
  - TMT in tubes (04 to 06 pos. packed in box)
  - SMT in tape-and-reel
- Optional: SMT in tubes (04 and 06 in box)

### PROCESSING INFORMATION

- Compatible with wave, vapor-phase, and IR reflow soldering processes

## TYPICAL APPLICATIONS

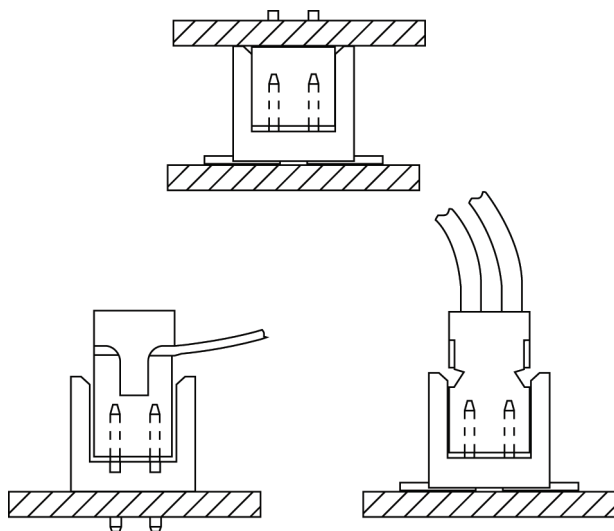

## PART NUMBERS

### CORE RANGE

98424 — G 52 — XX ALF

XX = 04, 06, 08, 10, 12, 16, 20

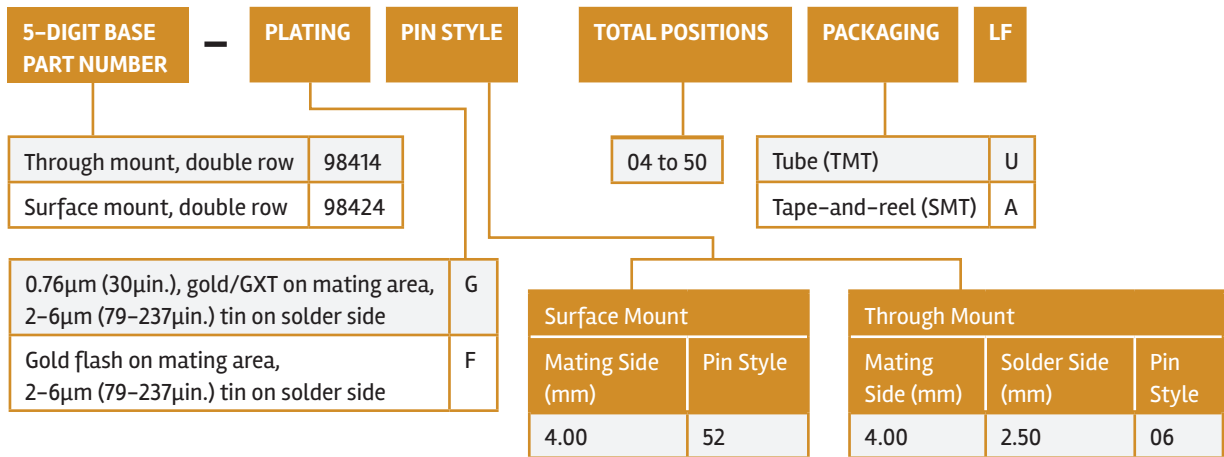

## PRODUCT

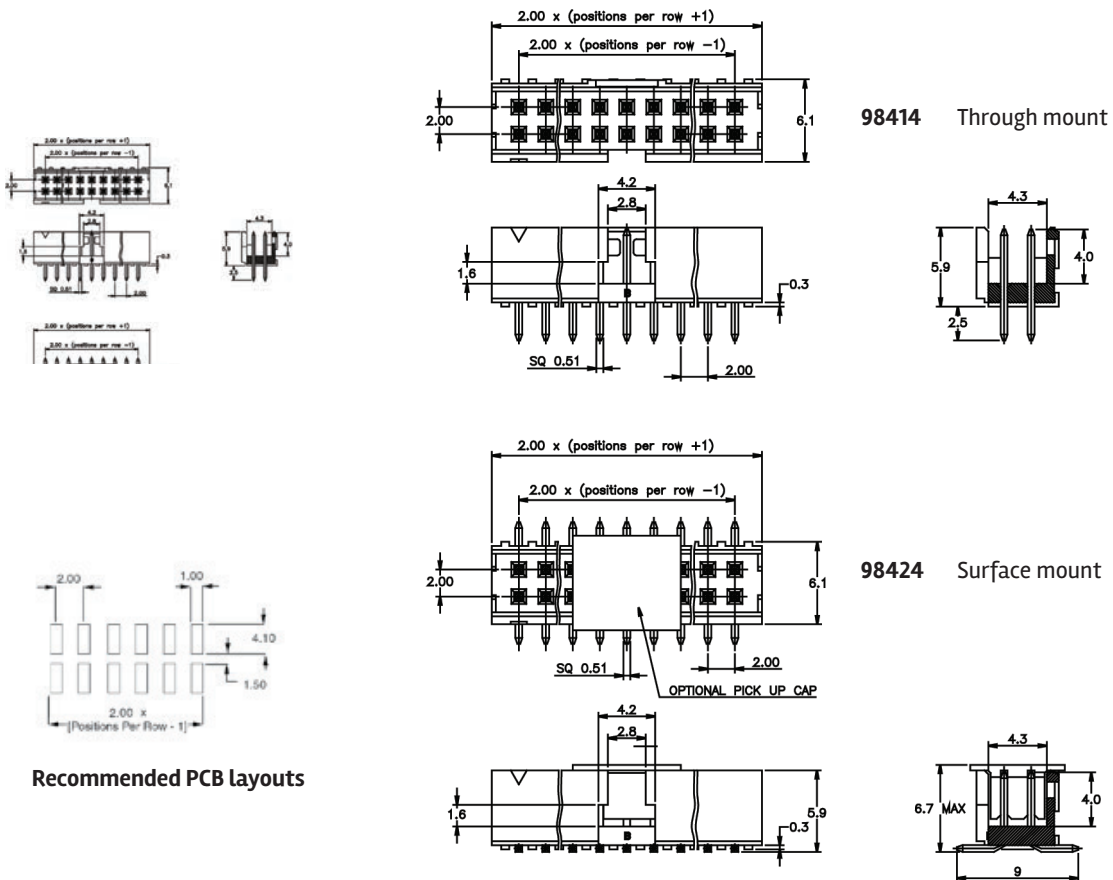

### Recommended PCB Layouts

Dimension in mm

For more information,  
please contact: [Communications@fci.com](mailto:Communications@fci.com)  
or visit us at [www.fci.com](http://www.fci.com)

**Disclaimer**  
Please note that the above information is subject to change without notice.



# MINITEK® SHROUDED RIGHT ANGLE HEADERS

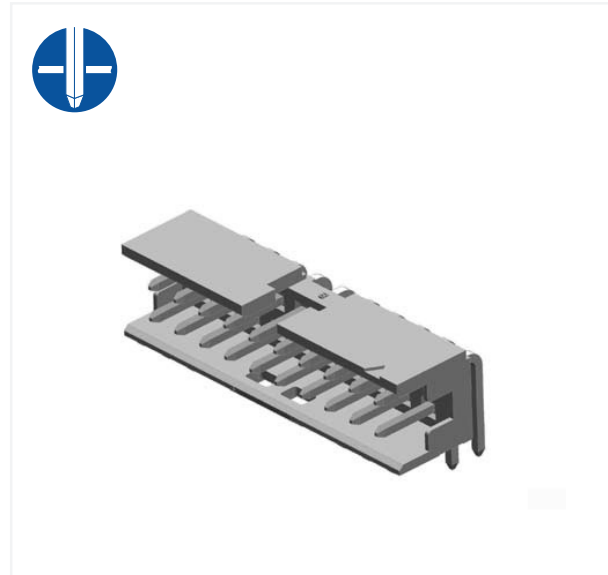

## FEATURES & BENEFITS

- 4-wall design prevents mis-mating
- Selective plating



## TECHNICAL INFORMATION

### MATERIALS

- Housing: High temperature, cream-coloured thermoplastic
- Flammability rating: UL94V-0
- Pin: Phosphor-bronze
- Plating: Gold/GXT over 1.27µm (50µin.) nickel

### ELECTRICAL PERFORMANCE

- Current rating: 2A continuous
- Insulation resistance: 1 x 10<sup>5</sup>MΩ min.
- Contact resistance: 25mΩ max.
- Dielectric withstanding voltage: 650V
- Voltage rating: 200V

### ENVIRONMENTAL

- Operating temperature range: -40°C to +125°C



### MECHANICAL PERFORMANCE

- Mating cycles (durability): 100

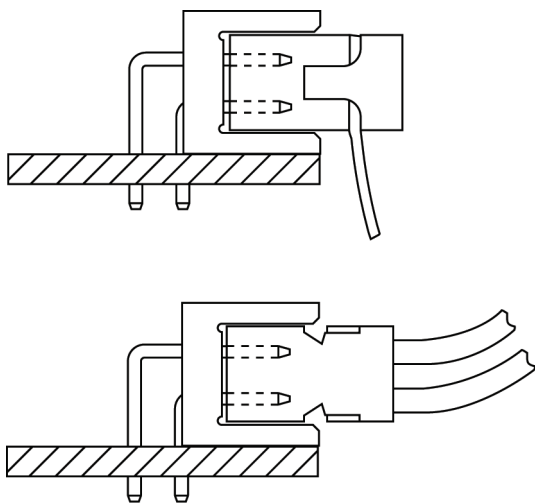
## TYPICAL APPLICATIONS



### SPECIFICATIONS

-  File no. E66906
-  File no. LR46923
- Product drawing: 98464
- Product specification: DPS-12-011 and GS-12-163

### APPROVALS AND CERTIFICATIONS

- This product is RoHS compatible according to the European Union Directive 2002/95/IEC

### PACKAGING

- Standard: Tubes (04 pos. packed in box)

### PROCESSING INFORMATION

- Compatible with wave, vapor-phase, and IR reflow soldering processes

## PART NUMBERS



0.76µm (30µin.) gold/GXT on mating area, 2-6µm (79-237µin.) tin on solder side	G
Gold flash on mating area, 2-6µm (79-237µin.) tin on solder side	F

04 to 50 (Double row)

## PRODUCTS

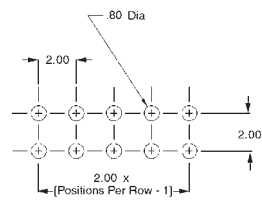

Recommended PCB layouts

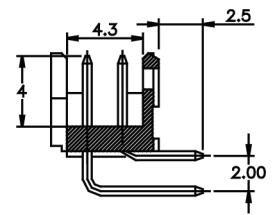
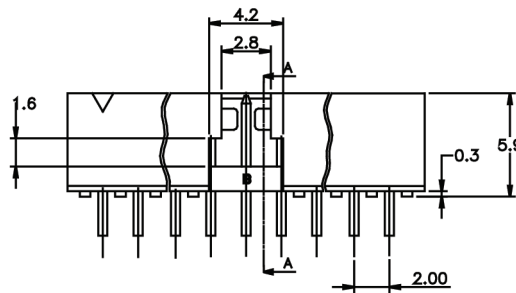
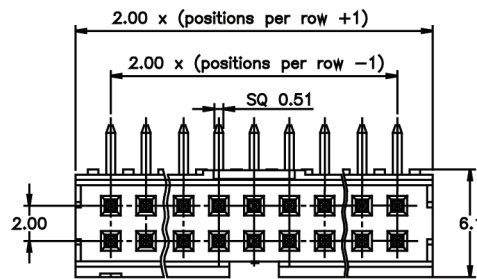

Dimension in mm

# MINITEK® SHROUDED HEADERS, PIN-IN-PASTE

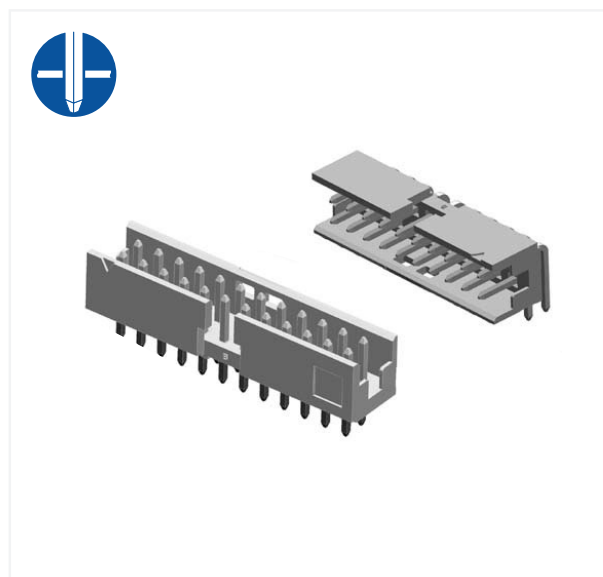

# MINITEK® SHROUDED HEADERS, PIN-IN-PASTE

## TECHNICAL INFORMATION

### MATERIALS

- Housing: High temperature, black thermoplastic
- Flammability rating: UL94V-0
- Pin: Phosphor-bronze
- Plating: Gold/GXT over 1.27µm (50µin.) nickel

### ELECTRICAL PERFORMANCE

- Current rating: 3A continuous
- Insulation resistance:  $1 \times 10^5 \text{M}\Omega$  min.
- Contact resistance: 25mΩ max.
- Dielectric withstanding voltage: 650V
- Voltage rating: 200V



### ENVIRONMENTAL

- Operating temperature range: -55°C to +125°C

### MECHANICAL PERFORMANCE

- Latching retention force: 30 N min.

### SPECIFICATIONS

-  File no. E66906
-  File no. LR46923
- Product drawing: 8-digit part number
- Product specification: DPS-12-011 and GS-12-163
- Application specification: TA-895
- Reflow prpfile: TA-842

### PACKAGING

- Tubes (04 pos. packed in box)
- Tape-on-reel with pick up cap

### PROCESSING INFORMATION

- Compatible with wave, vapor-phase, and IR reflow soldering processes

## TYPICAL APPLICATIONS

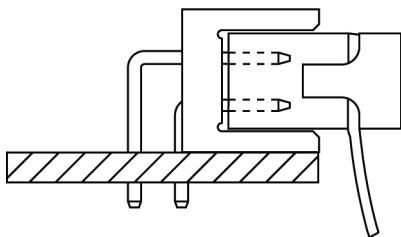
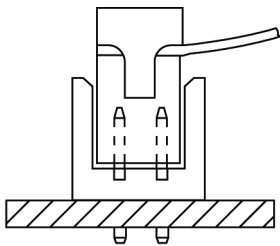

## PART NUMBERS

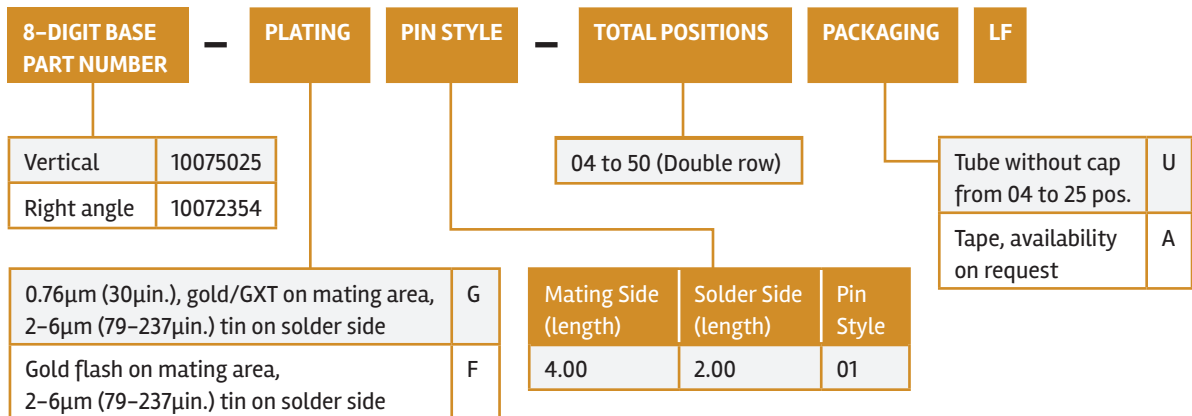

## PRODUCT

10075025

Vertical

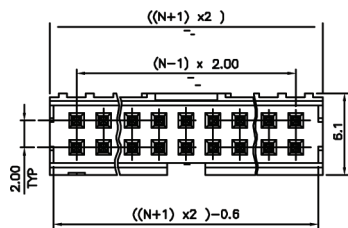

10072354

Right angle

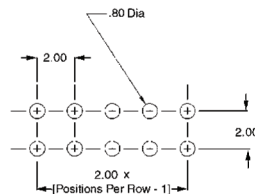
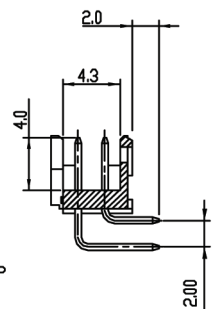
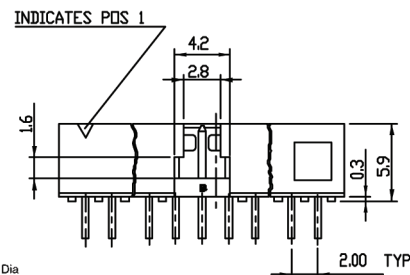
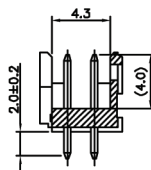
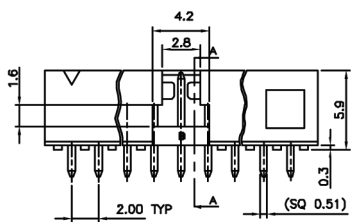
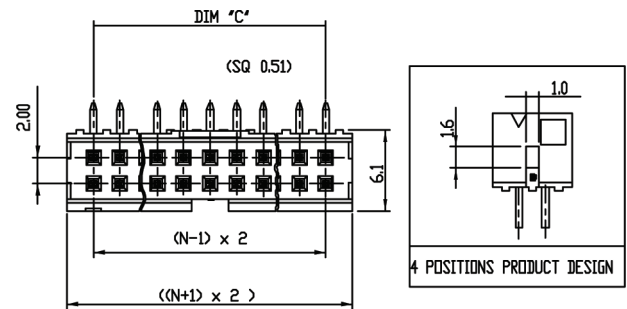

### Recommended PCB layouts

Dimension in mm

# MINITEK® SHROUDED HEADERS EJECT LATCH

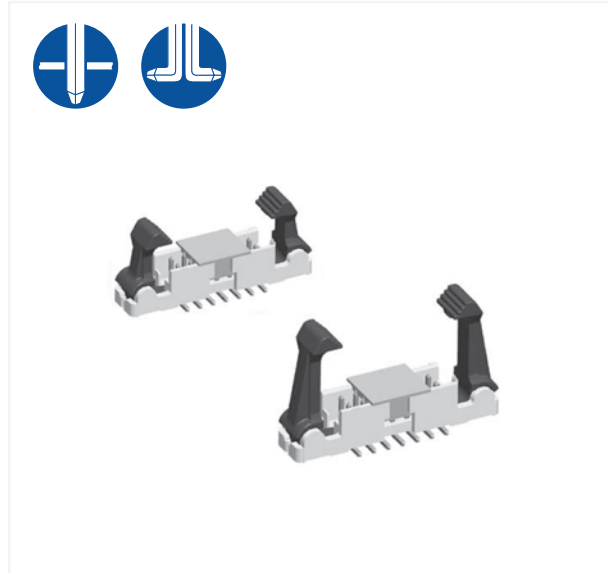

## FEATURES & BENEFITS

- Secure latching of cable connector
- Easy ejection when required
- Works with IDC connectors with or without strain relief
- Low profile

## TECHNICAL INFORMATION

### MATERIALS

- Housing: Body, cream-colored LCP, Latch black PA
- Flammability rating: UL94V-0
- Pin: Phosphor-bronze
- Plating: Gold/GXT over 1.27µm (50µin.) nickel

### ELECTRICAL PERFORMANCE

- Current rating: 2A continuous
- Insulation resistance: 1 x 10<sup>5</sup>MΩ min.
- Contact resistance: 25mΩ max.
- Dielectric withstanding voltage: 650V
- Voltage rating: 200V

### ENVIRONMENTAL

- Operating temperature range: -40°C to +125°C

### MECHANICAL PERFORMANCE

- Latching retention force: 30 N min.

## TYPICAL APPLICATIONS

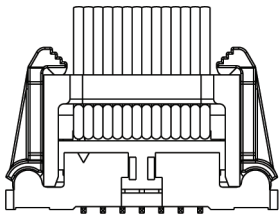

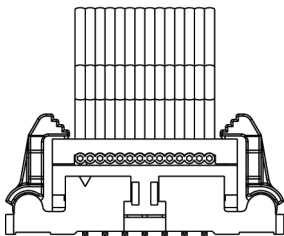

With strain relief  
standard latch



Without strain relief  
low profile latch

### SPECIFICATIONS

-  File no. E66906
-  File no. LR46923
- Product drawing: 8-digit part number
- Product specification: GS-12-469

### APPROVALS AND CERTIFICATIONS

- This product is RoHS compatible according to the European Union Directive 2002/95/IEC

### PACKAGING

- Standard: Tubes

### PROCESSING INFORMATION

- Compatible with wave, vapor-phase, and IR reflow soldering processes

## PART NUMBERS

### CORE RANGE

10078991	G	22	XX	U	LF
10078991	G	02	XX	U	LF

XX = 06, 08, 10, 12

8-DIGIT BASE PART NUMBER		G	PIN STYLE	LATCH TYPE	TOTAL POSITIONS	PACKAGING	LF	
Vertical TMT	10078991	G	Solder Side	Standard latch	6, 8, 10, 12, 14, 24, 30, 40, 44, 50	Tube, for through mount	U	
Vertical SMT	10078995			Low profile latch				2
0.76µm (30µin.) gold/GXT on mating area			Style					
			SMT	0	Tape-and-reel, SMT only*			A
			2.50mm TMT	2	Tube with cap, SMT only			B
			3.10mm TMT	3				

\* As available

## PRODUCT

### 10078991 Vertical TMT

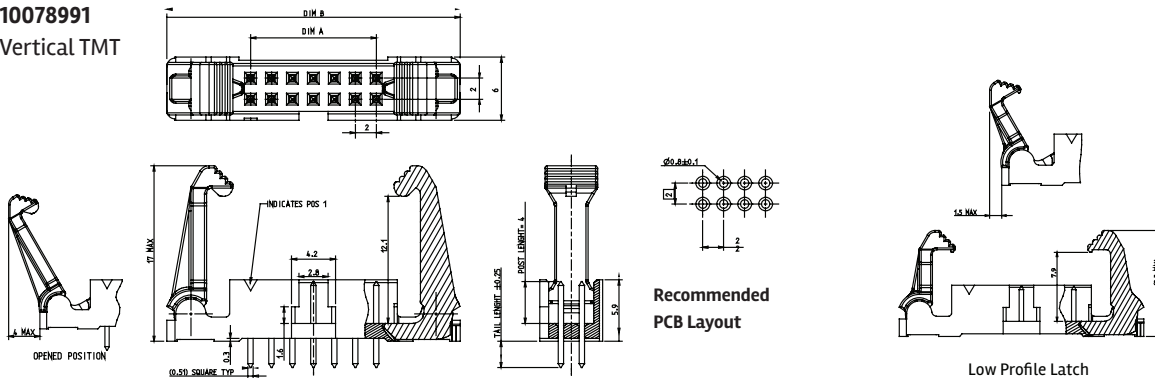

### 10078995 Vertical SMT

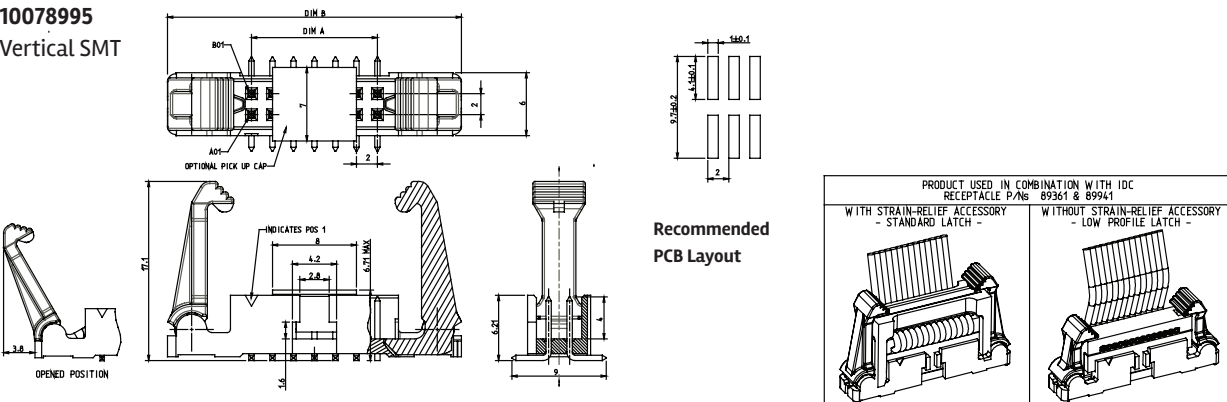

Dimension in mm

#### Disclaimer

Please note that the above information is subject to change without notice.

# MINITEK® CRIMP-TO-WIRE HOUSINGS AND CONTACTS



## FEATURES & BENEFITS

- Dual-beam contact design for highly reliable electrical performance
- Latching key assures proper alignment and friction retention





# MINITEK® CRIMP-TO-WIRE HOUSING AND CONTACTS



## TECHNICAL INFORMATION

### MATERIALS

- Housing: Black thermoplastic
- Flammability rating: UL94V-0
- Contact: Phosphor-bronze
- Plating: Gold or tin over 1.27µm (50µin.) nickel

### ELECTRICAL PERFORMANCE

- Current rating: 2A continuous
- Insulation resistance:  $1 \times 10^5 \text{M}\Omega$  min.
- Contact resistance: 20mΩ max.
- Dielectric withstanding voltage: 650V
- Voltage rating: 200V



### ENVIRONMENTAL

- Operating temperature range: -40°C to +125°C

### MECHANICAL PERFORMANCE

- Mating cycles (durability): 100
- Contact retention to housing: 7.83 N (800gf) min.
- Mating force per contact: 1.77 N (180gf) max.
- Unmating force per contact: 0.20 N (20gf) min.

### SPECIFICATIONS

-  File no. E66906
-  File no. LR46923
- Product drawing:
  - 77138 or 77139 – Contact
  - 69307, 90311 – Housing
- Product specification: 110-036
- Application specification: 100-006, TA-959

### APPROVALS AND CERTIFICATIONS

- This product is RoHS compatible according to the European Union Directive 2002/95/IEC

### PACKAGING

- Reels – Contacts
- Bags – Housings

### PROCESSING INFORMATION

- Compatible with wave, vapor-phase, and IR reflow soldering processes

### INSERTION DEPTH

- 2.40mm min. to 3.30mm max. [provides .381mm wipe]
- 3.63mm min. to 4.00mm max. [provides .381mm wipe in housing]

## TYPICAL APPLICATIONS

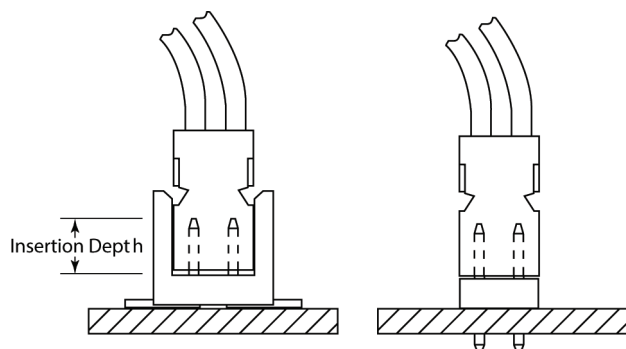

## PART NUMBERS

### CORE RANGE

77138	—	101LF
10087010	—	0XXLF

XX = 04, 06, 08, 10, 12, 16, 20

### CONTACTS

77138	—	PLATING	0	1	LF
26 AWG to 30 AWG		0.76µm (30µin.) gold on mating area		1	
		Gold flash		0	

### HOUSINGS

90311	—	0	TOTAL POSITIONS	LF
04 to 50 (Double row)				

## PRODUCT

### CONTACTS

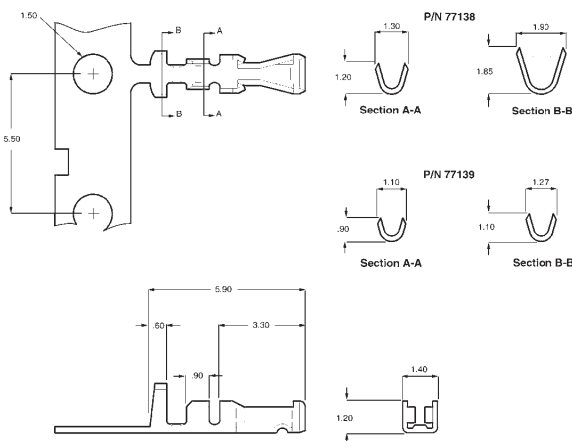

### HOUSINGS

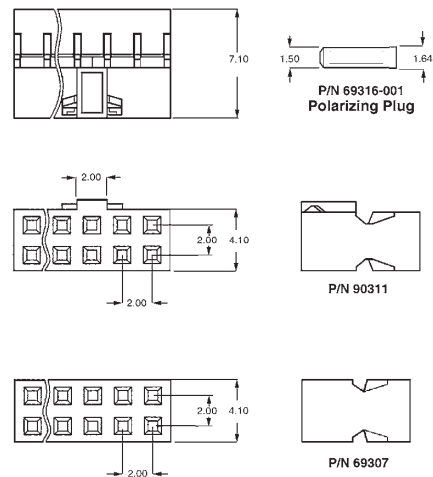

Dimension in mm

# MINITEK® CRIMP-TO-WIRE ACTIVE LATCH HOUSINGS

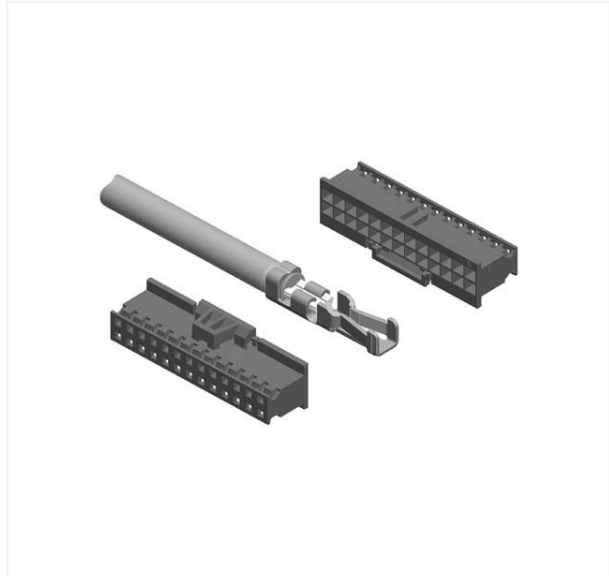

## FEATURES & BENEFITS

- Latching retention 15/25 N (depending on size) due to latch alone
- Latches with audible click
- Mates with standard Minitek® headers
- Latch can be released and parts unmated

## TECHNICAL INFORMATION

### MATERIALS

- Housing: Polyamide, black
- Flammability rating: UL94V-0

### ELECTRICAL PERFORMANCE

- Insulation resistance:  $1 \times 10^5 \text{M}\Omega$  min.
- Dielectric withstanding voltage: 500V

### ENVIRONMENTAL

- Operating temperature range:  $-55^\circ\text{C}$  to  $+125^\circ\text{C}$



### MECHANICAL PERFORMANCE

- Latching retention force: 15 N min. (for 2x3 and 2x4 pos.)
- Latching retention force: 25 N min. (for 2x5 and 2x25 pos.)

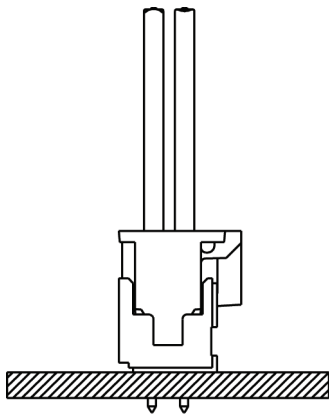
## TYPICAL APPLICATIONS



### SPECIFICATIONS

-  File no. E66906
-  File no. LR46923
- Product drawing: By 8-digit part number
- Product specification: GS-12-415

### APPROVALS AND CERTIFICATIONS

- This product is RoHS compatible according to the European Union Directive 2002/95/IEC

### PACKAGING

- Standard: Plastic bags



## PART NUMBERS

### CORE RANGE

77138 — 101LF

10073599 — 0XXLF

XX = 04, 08, 10, 12, 16, 20

### CONTACTS

77138 — PLATING 0 1 LF

26 AWG to 30 AWG

0.76µm (30µin.) gold on mating area	1
Gold flash	0

### HOUSINGS

10073599 — 0 TOTAL POSITIONS LF

06 to 50

## PRODUCT

### CONTACTS

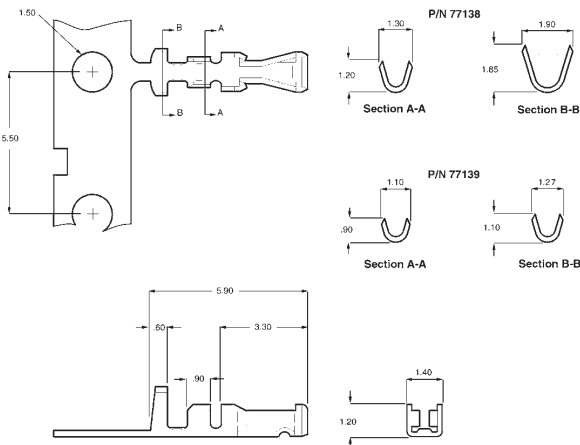

### HOUSINGS

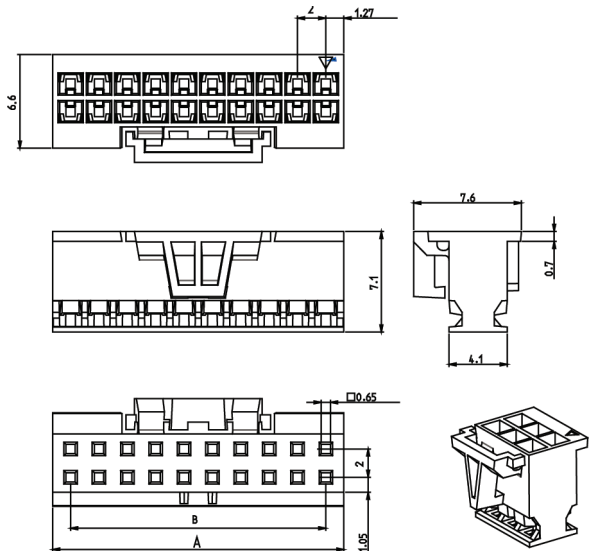

DESIGN FOR 10073599-006LF & 10073599-008LF ONLY

Dimension in mm

#### Disclaimer

Please note that the above information is subject to change without notice.

## MINITEK® IDC RECEPTACLE



### FEATURES & BENEFITS

- Early entry, single-beam contacts provide long wiping action for reliable electrical contact
- Center key polarization and friction latch options



## TECHNICAL INFORMATION

### MATERIALS

- Housing: Black thermoplastic
- Flammability rating: UL94V-0
- Contact: Phosphor-bronze
- Plating: Gold over 1.27µm (50µin.) nickel

### ELECTRICAL PERFORMANCE

- Current rating: 1A continuous
- Insulation resistance: 1 x 10<sup>5</sup>MΩ min.
- Contact resistance: 30mΩ max.
- Dielectric withstanding voltage: 650V



### ENVIRONMENTAL

- Operating temperature range: -40°C to +105°C

### MECHANICAL PERFORMANCE

- Mating cycles (durability): 100

### SPECIFICATIONS

-  File no. E66906
-  File no. LR46923
- Product drawing: 89947 or 89361
- Product specification: BUS-12-115

### APPROVALS AND CERTIFICATIONS

- This product is RoHS compatible according to the European Union Directive 2002/95/IEC

### PACKAGING

- Tubes

### INSERTION DEPTH

- 2.55mm min. to 4.57mm max.  
[provides .381mm wipe]

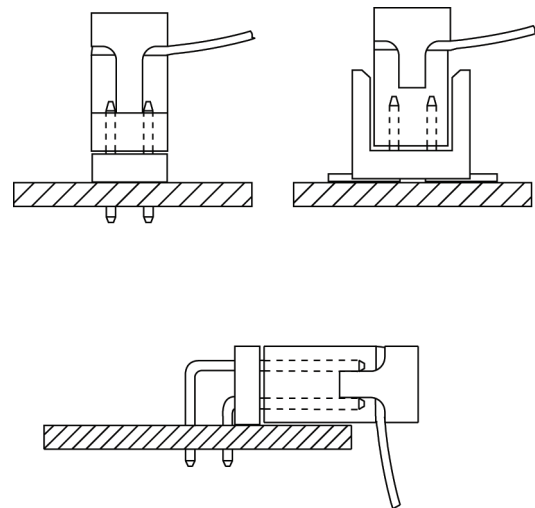

## PART NUMBERS

### CORE RANGE

89361 – 7XXLF

XX = 06, 08, 10, 12, 16, 20

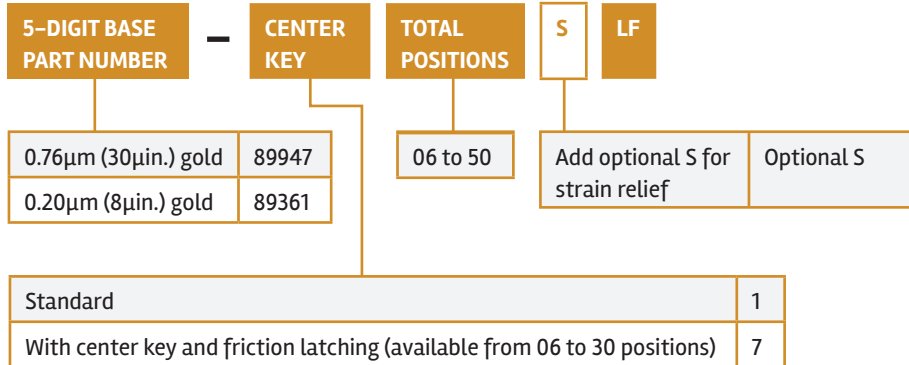

## PRODUCT

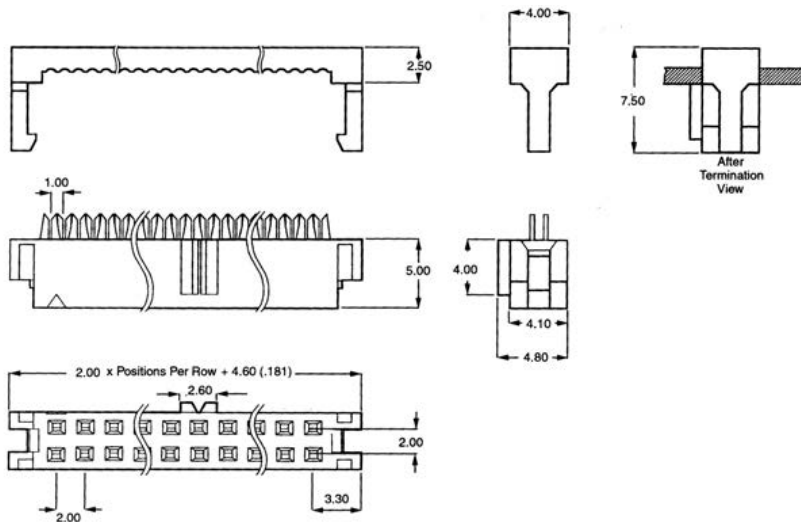

Dimension in mm

**Disclaimer**

Please note that the above information is subject to change without notice.



## MORE OPTIONS

If you need something more than the standard parts in this catalog, Basics+ has many more options to help you in your design process. Here are just some examples.

- Locating pins on SMT headers



- Polarized (missing) positions



- Kinked legs



- Press-fit pins

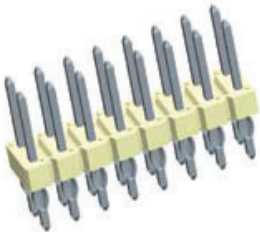

- Add-on latches for headers

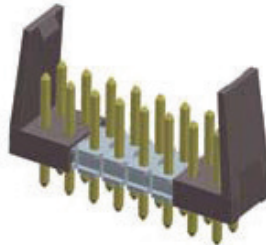

- Wide body headers

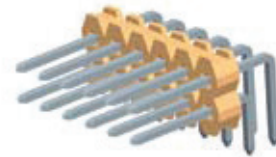

- Crimp-to-wire pin



- Printed housings



- Additional plating options

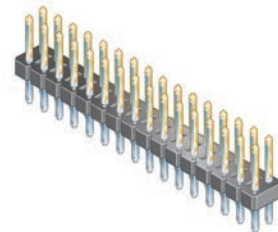

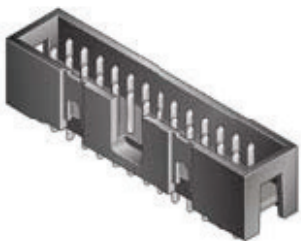

- Pin-in-paste headers









## Looking for pricing, stock, or lifecycle information?

Click below to explore more details on WIN SOURCE:

-  [View 10066848-103LF](#) on WIN SOURCE
-  [Amphenol](#) Information

## Optimize Your Supply Chain with WIN SOURCE Solutions

-  Global Sourcing Solution
-  Obsolete Management
-  Cost Control Management
-  Shortage Management
-  Alternative Solution
-  Excess Inventory Management