



**THE DATASHEET OF
E-TDA7590TR**



Features

- 24-bit, fixed point, 120 MIPS DSP core
- Large on-board memory (128KW-24 bit)
- Host access to internal RAM through expansion port
- Access to external RAM (16Mw) through expansion port
- Integrated stereo, 18-bit Sigma-DELTA A/D and 20-bit D/A converters
- Programmable CODEC sample rate up to 48 kHz
- On-board PLL for core clock and converters
- External Flash/SRAM memory bank management
- I²C and SCI serial interface for external control
- 2 enhanced synchronous serial interface (ESSI)
- JTAG interface
- Host interface
- 144-pin TQFP, 0.50 mm pitch
- Automotive temperature range (from -40 °C to +85 °C)

Applications

- Real time digital speech and audio processing:
 - speech recognition
 - speech synthesis
 - speech compression
 - echo canceling
 - noise canceling



- MP3 decoding

Description

The TDA7590 is a high performances, fully programmable 24-bit, 120 MIPS. Digital signal processor (DSP), designed to support several speech and audio applications, as automatic speech recognition, speech synthesis, MP3 decoding, echo and noise cancellation.

Nevertheless, the embedded CODECs bandwidth and the generic processing engine allow to proceed also full-band audio signals. The large amount of on-chip memory (128 Kwords), together with the 16 Mwords external memory addressable and the 32 general purpose I/O pins permit to build a DSP-system avoiding the usage of an additional microcontroller.

The presence of serial and parallel interfaces allows easy connection with external devices including CODECs, DSPs, microprocessors and personal computers.

In particular, the debug/JTAG interface permits the on-chip emulation of the firmware developed. Further, the presence of the timers and watchdog block makes TDA7590 suitable for PWM processing and allows the integration of a system watchdog.

Table 1. Device summary

Order code	Package	Packing
E-TDA7590	TQFP144 (20x20x1.0 exposed pad down) ⁽¹⁾	Tray
E-TDA7590TR		Tape and reel

1. In ECOPACK® package (see [Section 8: Package information on page 22](#)).

Contents

1	Block diagram	6
2	Pin description	7
	2.1 Pin connection	7
	2.2 Pin function	8
	2.3 Thermal data	13
3	Key parameters	14
	3.1 Power consumption	14
	3.1.1 CODEC (ADC/DAC) test description	15
4	Electrical specification	16
	4.1 Absolute maximum ratings	16
	4.2 Electrical characteristics for I/O pins	16
5	24 bit DSP core	17
6	Memories	18
7	DSP peripherals	19
	7.1 Serial audio interface (SAI)	19
	7.2 Serial communication interface (SCI)	19
	7.3 I ² C interface	19
	7.4 Host interface (HI)	19
	7.5 ESSI	20
	7.6 EOC	20
	7.7 Timers and watchdog block	21
	7.8 PLL	21
	7.9 CODEC cell	21
8	Package information	22
9	Appendix 1	23

9.1 Benchmarking program 23

Revision history 41

List of tables

Table 1.	Device summary	1
Table 2.	Pin function	8
Table 3.	Thermal data	13
Table 4.	Key parameters	14
Table 5.	Absolute maximum ratings	16
Table 6.	Recommended DC operating conditions	16
Table 7.	General interface electrical characteristics	16
Table 8.	Document revision history	41

List of figures

Figure 1.	Block diagram	6
Figure 2.	Pin connection (top view)	7
Figure 3.	TQFP144 mechanical data and package dimensions	22

1 Block diagram

Figure 1. Block diagram

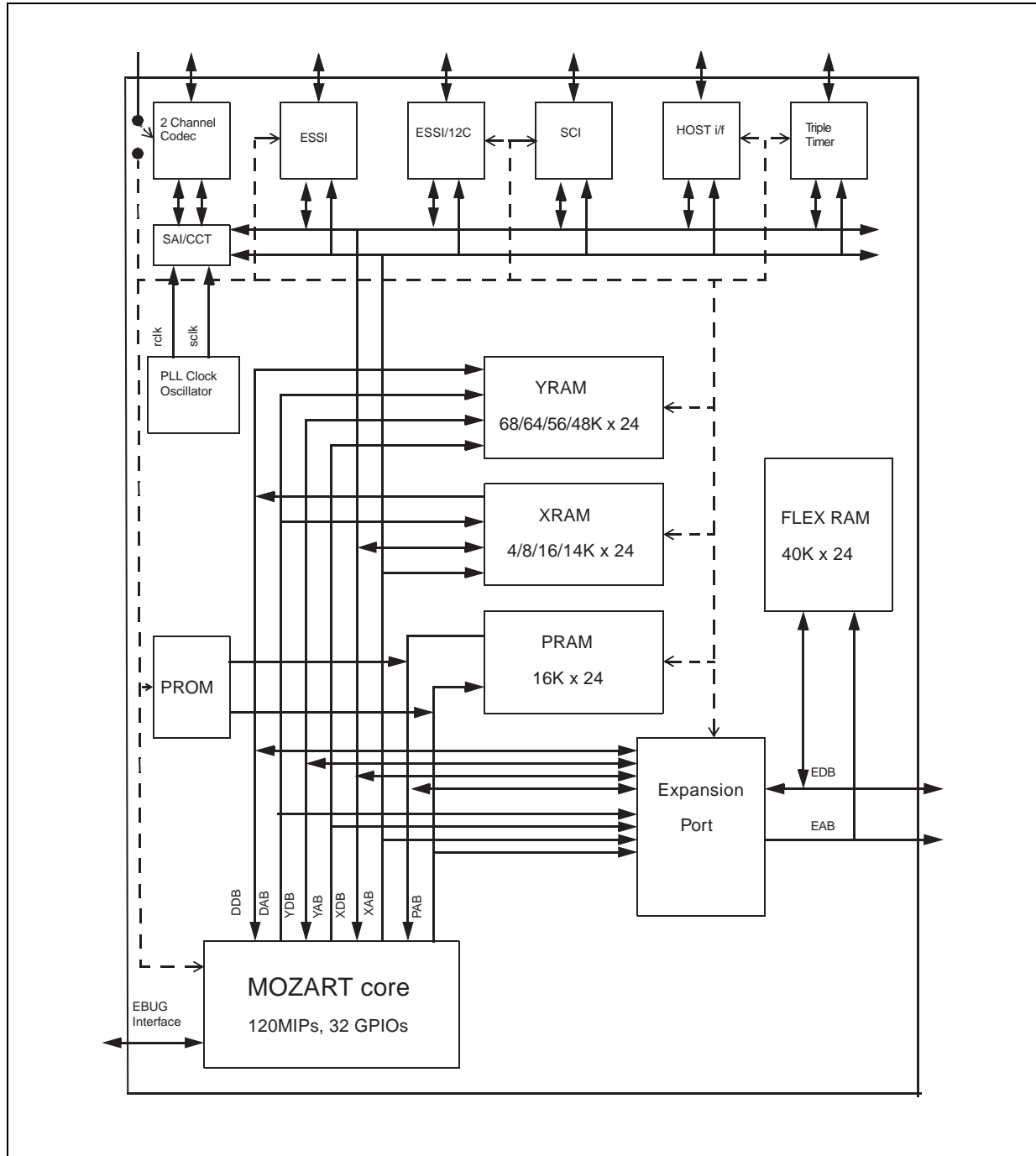

2 Pin description

2.1 Pin connection

Figure 2. Pin connection (top view)

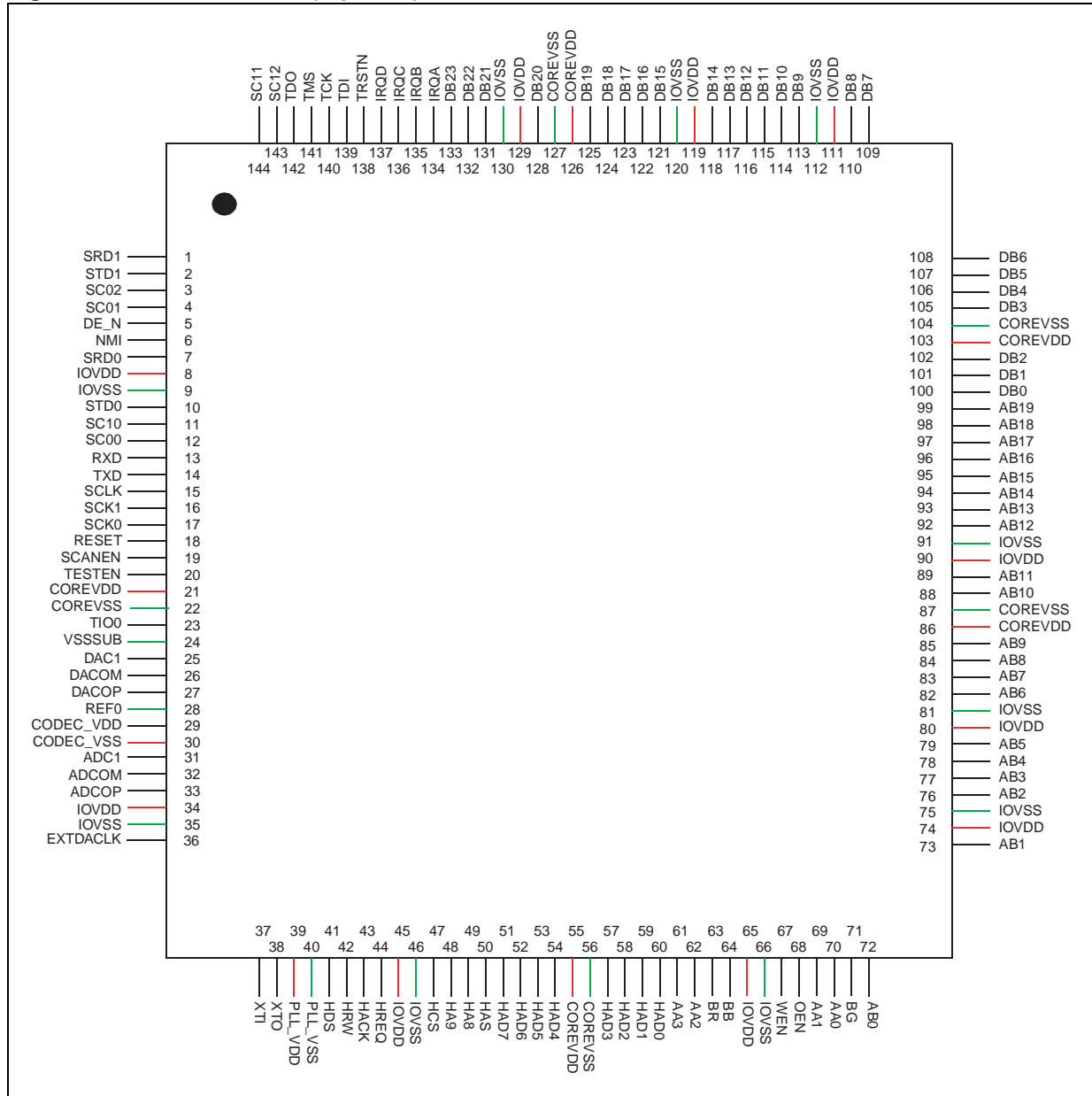

2.2 Pin function

Table 2. Pin function

N°	Name	Type	Description
1	SRD1/TI02	I/O	Serial receive data. Serial input data for receiver. Timer 2 input/output.
2	STD1	I/O	Serial transmit data. Serial output data from transmitter.
3	SC02	I/O	Serial control 2. Transmitter frame sync only in asynchronous mode, transmitter and receiver frame sync in synchronous mode.
4	SC01	I/O	Serial control 1. Receive frame sync in asynchronous mode, output from transmitter 2 or serial flag 1 in synchronous mode.
5	DE_N	I/O	Test data output (input/output). Debug request input and acknowledge output.
6	NMI_N	I	Non-maskable interrupt/ PINIT. Used to enable the PLL during RESET and as a non-maskable interrupt at all other times.
7	SRD0	I/O	Serial receive data. Serial input data for receiver.
8	IOVDD	I	IO power supply.
9	IOVSS	I	IO ground.
10	STD0	I/O	Serial Transmit Data. Serial output data from transmitter.
11	SC10/SCL	I/O	ESSI1 serial control 0. Receive clock in asynchronous mode, output from transmitter or serial flag in synchronous mode. I ² C SCL serial clock line.
12	SC00	I/O	Serial control 0. Receive clock in asynchronous mode, output from transmitter 1 or serial flag 0 in synchronous mode.
13	RXD	I/O	SCI receive data. Receives byte-oriented serial data.
14	TXD	I/O	SCI read enable. Transmits serial data from SCI transmit shift register.
15	SCLK	I/O	SCI serial clock. Input or output clock from which data is transferred in synchronous mode and from which the transmit and/or receive baud rate is derived in asynchronous mode.
16	SCK1/TI01	I/O	Serial clock. Serial bit clock for transmitter only in asynchronous mode, serial bit clock for both receiver and transmitter in synchronous mode. Timer 1 input/output.
17	SCK0	I/O	Serial clock. Serial bit clock for transmitter only in asynchronous mode, serial bit clock for both receiver and transmitter in synchronous mode.
18	RESETN	I	System reset. A low level applied to RESET_N input initializes the IC.
19	SCANEN	I	SCAN enable. When active with TESTEN also active, controls the shifting of the internal scan chains.
20	TESTEN	I	Test enable. When active, puts the chip into test mode and muxes the XTI clock to all flip-flops. When SCANEN is also active, the scan chain shifting is enabled.
21	COREVSS	I	Core ground.
22	COREVDD	I	Core power supply.
23	TIO0	I/O	Timer 0 input/output.
24	VSSSUB	I	Analog substrate isolation.

Table 2. Pin function (continued)

N°	Name	Type	Description
25	DAC1	O	DAC1 left single analog output.
26	DAC0M	O	DAC0 negative right differential analog output.
27	DAC0P	O	DAC0 positive right differential analog output.
28	CODEC_VSS	I	Voltage ground.
29	REF0	I	Codec power supply.
30	CODEC_VDD	I	Codec reference.
31	ADC1	I	ADC1 left single analog input.
32	ADC0M	I	DAC0 negative right differential analog inputs.
33	ADC0P	I	DAC0 positive right differential analog inputs.
36	EXTDACLK	I	External DAC clock. Optional external clock source from which LRCLK and SCLK can be generated.
37	XTI	I	Crystal oscillator input. External clock input or crystal connection.
38	XTO	O	Crystal oscillator output. Crystal oscillator output drive.
39	PLL_VDD	I	PLL power supply.
40	PLL_VSS	I	PLL ground input.
41	HDS	I/O	Host data strobe. Polarity programmable Host data strobe input for single strobe mode. Polarity programmable Host write strobe input for double strobe mode.
42	HRW	I/O	Host read/write. Host read/write for single strobe bus mode. Polarity programmable Host read data strobe for double strobe mode.
43	HACK	I/O	Host acknowledge. Polarity programmable host interrupt acknowledge for single host request mode. Polarity programmable host receive request interrupt for double host request mode.
44	HREQ	I/O	Host request. Polarity programmable host request interrupt for single host request mode. Polarity programmable host transfer request interrupt for double host request mode.
45	IOVDD	I	IO power supply.
46	IOVSS	I	IO ground.
47	HCS	I/O	Host chip select. Polarity programmable host chip select for non-multiplexed mode. Host address Line 10 for multiplexed mode.
48	HA9	I/O	Host address 9. Address line 9 in multiplexed mode otherwise address line 2 in non-multiplexed mode.
49	HA8	I/O	Host address 8. Address line 8 in multiplexed mode otherwise address line 1 in non-multiplexed mode.
50	HAS	I/O	Host address strobe. Address strobe for multiplexed bus or Address 0 for non multiplexed.
51	HAD[7]	I/O	Host 8-bit data line 7. Host data bus and/or address lines when in multiplexed mode.

Table 2. Pin function (continued)

N°	Name	Type	Description
52	HAD[6]	I/O	Host 8-bit data line 6. Host data bus and/or address lines when in multiplexed mode.
53	HAD[5]	I/O	Host 8-bit data line 5. Host data bus and/or address lines when in multiplexed mode.
54	HAD[4]	I/O	Host 8-bit data line 4. Host data bus and/or address lines when in multiplexed mode.
55	COREVDD	I	Core power supply.
56	COREVSS	I	Core ground.
57	HAD[3]	I/O	Host 8-bit data line 3. Host data bus and/or address lines when in multiplexed mode.
58	HAD[2]	I/O	Host 8-bit data line 2. Host data bus and/or address lines when in multiplexed mode.
59	HAD[1]	I/O	Host 8-bit data line 1. Host data bus and/or address lines when in multiplexed mode.
60	HAD[0]	I/O	Host 8-bit data line 0. Host data bus and/or address lines when in multiplexed mode.
61	AA[3]	O	Address attributes line 3.Port A address attributes/chip select pins with programmable polarity.
62	AA[2]	O	Address attributes line 2.Port A address attributes/chip select pins with programmable polarity.
63	BR_N	O	Bus request. Asserted when port A requires bus mastership to perform off-chip accesses.
64	BB_N	I/O	Bus busy. Asserted by port A when bus_busy_in_n is negated and BG_N is asserted.
65	IOVDD	I	IO power supply.
66	IOVSS	I	IO ground.
67	WEN_N	O	Write enable.
68	OEN_N	O	Output enable.
69	AA[1]	O	Address attributes line 1.Port A address attributes/chip select pins with programmable polarity.
70	AA[0]	O	Address attributes line 0.Port A address attributes/chip select pins with programmable polarity.
71	BG_N	I	Bus grant. When asserted, Port A becomes the bus master elect. Bus mastership is attained when bus busy is negated by the current bus master.
72	AB[0]	O	Address bus line 0. Port A external address bus.
73	AB[1]	O	Address bus line 1. Port A external address bus.
74	IOVDD	I	IO power supply.
75	IOVSS	I	IO ground.
76	AB[2]	O	Address bus line 2. Port A external address bus.

Table 2. Pin function (continued)

N°	Name	Type	Description
77	AB[3]	O	Address bus line 3. Port A external address bus.
78	AB[4]	O	Address bus line 4. Port A external address bus.
79	AB[5]	O	Address bus line 5. Port A external address bus.
80	IOVDD	I	IO power supply.
81	IOVSS	I	IO ground.
82	AB[6]	O	Address bus line 6. Port A external address bus.
83	AB[7]	O	Address bus line 7. Port A external address bus.
84	AB[8]	O	Address bus line 8. Port A external address bus.
85	AB[9]	O	Address bus line 9. Port A external address bus.
86	COREVDD	I	Core power supply.
87	COREVSS	I	Core ground.
88	AB[10]	O	Address bus line 10. Port A external address bus.
89	AB[11]	O	Address bus line 11. Port A external address bus.
90	IOVDD	I	IO power supply.
91	IOVSS	I	IO ground.
92	AB[12]	O	Address bus line 12. Port A external address bus.
93	AB[13]	O	Address bus line 13. Port A external address bus.
94	AB[14]	O	Address bus line 14. Port A external address bus.
95	AB[15]	O	Address bus line 15. Port A external address bus.
96	AB[16]	O	Address bus line 16. Port A external address bus.
97	AB[17]	O	Address bus line 17. Port A external address bus.
98	AB[18]	O	Address bus line 18. Port A external address bus.
99	AB[19]	O	Address bus line 19. Port A external address bus.
100	DB[0]	I/O	Address bus 0. Port A external data bus.
101	DB[1]	I/O	Address bus 1. Port A external data bus.
102	DB[2]	I/O	Address bus 2. Port A external data bus.
103	COREVDD	I	Core power supply.
104	COREVSS	I	Core ground.
105	DB[3]	I/O	Data bus line 3. Port A external data bus.
106	DB[4]	I/O	Data bus line 4. Port A external data bus.
107	DB[5]	I/O	Data bus line 5. Port A external data bus.
108	DB[6]	I/O	Data bus line 6. Port A external data bus.
109	DB[7]	I/O	Data bus line 7. Port A external data bus.
110	DB[8]	I/O	Data bus line 8. Port A external data bus.
111	IOVDD	I	IO Power Supply.

Table 2. Pin function (continued)

N°	Name	Type	Description
112	IOVSS	I	IO Ground.
113	DB[9]	I/O	Data Bus line 9. Port A external data bus.
114	DB[10]	I/O	Data bus line 10. Port A external data bus.
115	DB[11]	I/O	Data bus line 11. Port A external data bus.
116	DB[12]	I/O	Data bus line 12. Port A external data bus.
117	DB[13]	I/O	Data bus line 13. Port A external data bus.
118	DB[14]	I/O	Data bus line 14. Port A external data bus.
119	IOVDD	I	IO power supply.
120	IOVSS	I	IO Ground.
121	DB[15]	I/O	Data bus line 15. port a external data bus.
122	DB[16]	I/O	Data bus line 16. Port A external data bus.
123	DB[17]	I/O	Data bus line 17. Port A external data bus.
124	DB[18]	I/O	Data bus line 18. Port A external data bus.
125	DB[19]	I/O	Data bus line 19. Port A external data bus.
126	COREVDD	I	Core power supply.
127	COREVSS	I	Core ground.
128	DB[20]	I/O	Data bus line 20. Port A external data bus.
129	IOVDD	I	IO power supply.
130	IOVSS	I	IO ground.
131	DB[21]	I/O	Data bus line 21. Port A external data bus.
132	DB[22]	I/O	Data bus line 22. Port A external data bus.
133	DB[23]	I/O	Data bus line 23. Port A external data bus.
134	IRQA	I	Interrupt request line/ Mode control. Used as mode control during RESET and as interrupt request line at all other times.
135	IRQB	I	Interrupt request line/ Mode control. Used as mode control during RESET and as interrupt request line at all other times.
136	IRQC	I	Interrupt request line/ Mode control. Used as mode control during RESET and as interrupt request line at all other times.
137	IRQD	I	Interrupt request line/ Mode control. Used as mode control during RESET and as interrupt request line at all other times.
138	TRSTN	I	Test reset. JTAG output pin for serial data out from debug interface.
139	TDI	I	Test data input. JTAG input pin for serial data input for debug interface.
140	TCK	I	Test clock. JTAG input pin for clocking debug interface.
141	TMS	I	Test mode select. JTAG input pin for control of TAP Controller of debug interface.
142	TDO	O	Test data output. JTAG output pin for serial data out from debug interface.

Table 2. Pin function (continued)

N°	Name	Type	Description
143	SC12	I/O	Serial control 2. Transmitter frame sync only in asynchronous mode, transmitter and receiver frame sync in synchronous mode.
144	SC11/SDA	I/O	Serial control 1. Receive frame sync in asynchronous mode, output from transmitter 2 or serial flag 1 in synchronous mode. I ² C SDA. Serial data line.

2.3 Thermal data

Table 3. Thermal data

Symbol	Parameter	Value	Unit
R _{th-j-pins}	Thermal resistance junction to pins	32	°C/W

3 Key parameters

3.1 Power consumption

Power consumption depends on application running and DSP clock frequency.

Supply current values are measured and guaranteed at testing level by adopting the benchmarking program reported in Appendix 1.

Table 4. Key parameters

Symbol	Parameter	Min.	Typ.	Max.	Unit
General					
fosc	Crystal frequency			16	MHz
CORE_VDD	Operating voltage	1.62	1.8	1.98	V
CODEC_VDD	Operating voltage	3.0	3.3	3.6	V
IOVDD	Operating voltage	3.0	3.3	3.6	V
PLL_VDD	Operating voltage	3.0	3.3	3.6	V
IDD_1.8V	Supply current			150	mA
IDD_3.3V	Supply current			50	mA
Tamb	Operating temperature	-40		85	°C
DSP core					
fdsp	DSP clock frequency			120	MHz
ADC single ended					
Vpp	Maximum input range at ADC1			1.4	V
THD/S	Total harmonics distortion to signal		-71		dB
(THD+N)/S	(THD + Noise) to signal		-70		dB
DR	Dynamic range		75		dB
ICL	Interchannel Isolation		-100		dB
ADC differential					
Vpp	Maximum input range at ADC0M-ADC0P			2.8	V
THD/S	Total harmonics distortion to signal		-65		dB
(THD+N)/S	(THD + Noise) to signal		-65		dB
DR	Dynamic range		84		dB
ICL	Interchannel isolation		-100		dB
DAC single ended					
Vpp	Maximum input range at ADC1			1.4	V
THD/S	Total harmonics distortion to signal		-64		dB
(THD+N)	(THD + Noise) to signal		-60		dB

Table 4. Key parameters (continued)

Symbol	Parameter	Min.	Typ.	Max.	Unit
DR	Dynamic range		89		dB
ICL	Interchannel isolation		-100		dB
DAC differential					
V _{pp}	Maximum input range at ADC1			2.8	V
THD/S	Total harmonics distortion to signal		-58		dB
(THD+N)/S	(THD + Noise) to signal		-57		dB
DR	Dynamic range		90		dB
ICL	Interchannel Isolation		-85		dB

3.1.1 CODEC (ADC/DAC) test description

Reported typical values (table 3. - ADC and DAC sections) have been measured at Lab level during product evaluation phase. General definitions and procedures are separately defined in following dedicated paragraphs.

Total harmonic distortion with noise to signal (THD+N)/S

THD+N is defined as the ratio of the total power of the second power and higher harmonic with noise components to the power of the fundamental for that signal. For THD+N measurement, choose the DSP analyzer in digital analyzer with THD ratio as measurement option. Measure the THD+N value at -3 dB amplitude of the input signal. First measure the THD+N value at 1V_{rms} which is 0 dB reference and then measure the value at -3 dB reference.

Dynamic range (DR)

DR is defined as the level of THD+N measured when the input sine wave amplitude is so small that no harmonics apart from the fundamental tone are present in the output signal. This way THD+N becomes practically the ratio between the whole signal and noise floor, being a different way to express SNR. As a convention, at which no harmonics should be present in the output signal, it is fixed at -40dB of the full scale amplitude.

Crosstalk or interchannel isolation

A disturbance, caused by electromagnetic interference, along a circuit or a cable pair. An electric signal disrupts another signal in an adjacent circuit and can cause it to become confused and cross over each other. Crosstalk is measured by applying a signal -3dB amplitude of input signal at one channel (A) and no signal at an other channel (B), measuring the effect on this channel (B) because of the channel (A).

Total harmonic distortion to signal (THD)/S

THD is defined as the ratio of the sum of only those components of the output signal which are harmonic of system input, after having removed the fundamental tone corresponding to the pure sine wave as input and the input signal. This measurement is done by using the Harmonic analyzer which can isolate up to 15th harmonic components on the acquired signal and report the sum of all of them, centering the fundamental tone on the frequency provided by the input signal generator. These measurements are performed at -3dB reference amplitude of input signal.

4 Electrical specification

4.1 Absolute maximum ratings

Table 5. Absolute maximum ratings

Symbol	Parameter	Value	Unit
PLL_VDD	3.3V PLL power supply voltage	-0.5 to 4	V
CODEC_VDD	3.3V CODEC analog power supply	-0.5 to 4	V
IOVDD	3.3V IO power supply	-0.5 to 4	V
CORE_VDD	1.8V CORE power supply	-0.5 to 2.2	V
IO_MAX	Input or output voltage	-0.5 to (IOVDD +0.5)	V

4.2 Electrical characteristics for I/O pins

Table 6. Recommended DC operating conditions

Symbol	Parameter	Value	Unit
IOVDD	IO power supply voltage	3 to 3.6 ⁽¹⁾	V
T _j	Operating junction temperature	-40 to 105	°C

1. All the specification are valid only within these recommended operating conditions.

Table 7. General interface electrical characteristics

Symbol	Parameter	Test condition	Min.	Typ.	Max.	Unit
I _{il}	Low level input current without pull-up device				1	μA
I _{ih}	High level input current without pull-down device				1	μA
I _{oz}	Tri-state output leakage without pull up/down device				1	μA
I _{ozFT}	Five Volt tolerant tri-state output leakage without pull up/down device				1	μA
I latch-up	I/O latch-up current	V < 0V, V < V _{dd}	200			mA
V _{esd}	Electrostatic protection (HBM)	leakage < 1mA	2000			V
V _{il}	Low level input voltage ⁽¹⁾				0.8	V
V _{ih}	High level input voltage ⁽¹⁾		2			V
V _{hyst}	Schmitt trigger hysteresis ⁽¹⁾		0.4			V
V _{ol}	Low level output voltage ^{(1) (2) (3)}	I _{ol} = XmA			0.15	V
V _{oh}	High level output voltage ^{(1) (2) (3)}	I _{oh} = -XmA	IOVDD - 0.15			V

1. TTL specifications only apply to the supply voltage range V_{dd} = 3.15V to 3.6V.

2. Takes into account 200mV voltage drop in both supply lines.

3. X is the source/sink current under worst case conditions and is reflected in the name of the I/O cell according to the drive capability.

5 24 bit DSP core

The DSP core is a general purpose 24-bit DSP. The main feature of the DSP core are listed below:

- 120 MHz operating frequency (120 MIPS)
- Fully pipelined 24 x 24 bit parallel multiplier-accumulator
- Saturation/limiting logic
- 56-bit parallel barrel shifter
- Linear, reverse carry and modulo addressing modes
- 24-bit address buses for program, X and Y data spaces and DMA
- Memory-expandible hardware stack
- Nested zero-overhead DO loops
- Fast interrupts
- Powerful JTAG emulation port
- Software wait and stop low power standby modes
- Program address tracing support
- Two 24-bit data moves in parallel with arithmetic operations
- External interrupts including non-maskable interrupt
- Interrupts may be independently masked and prioritized
- Bit-manipulation instructions can access any register or memory location
- On board support for DMA controller

6 Memories

128 K x 24-bit RAM divided into 4 areas, program RAM(PRAM), X data RAM(XRAM), Y data RAM(YRAM) and flexible allocation RAM(FLEX) as follows:

- 16 kB PRAM
- 40 kB FLEX RAM. FLEX RAM is accessed through the expansion port by the DSP core.
- External access to the FLEX RAM is also supported.
- 72 kB RAM is allocated as XRAM and YRAM. Four configurations are supported:
 - 4 kB XRAM and 68 kB YRAM
 - 8 kB XRAM and 64 kB YRAM
 - 16 kB XRAM and 56 kB YRAM
 - 24 kB XRAM and 48 kB YRAM

7 DSP peripherals

7.1 Serial audio interface (SAI)

The SAI is used to communicate between the CODEC and the DSPs.

In addition, digital audio can be directly input for processing. There is only one SAI found on the chip that can be accessed by either the DSP or the DMA controller. The main features of this block are listed below:

- Slave operating modes, all clock lines can be inputs or outputs
- Transmit and receive interrupt logic triggers on left/right data pairs
- Receive and transmit data registers have two locations to hold left and right data

7.2 Serial communication interface (SCI)

The serial communication interface provides a full duplex port for serial communication to other DSPs, microprocessors, and peripherals like modems.

The interface supports the following features:

- No additional logic for connection to other TTL level peripherals
- Asynchronous bit rates and protocols "High speed" synchronous data transmission.
- Asynchronous protocol includes Multidrop mode for master/slave operation with wake-up on Idle line and wake-up on address bit capability, permitting the SCI to share a single line with multiple peripherals
- Transmit and receive logic can operate asynchronously from each other.
- A programmable baud-rate generator which provide the transmit and receive clocks or functions as a general purpose timer.

7.3 I²C interface

The inter integrated-circuit bus is a simple bi-directional two-wire bus used for efficient inter IC control. All I²C bus compatible devices incorporate an on-chip interface which allows them to communicate directly with each other via the I²C bus.

Every component connected to the I²C bus has its own unique address whether it is a CPU, memory or some other complex function chip. Each of these chips can act as a receiver and/or transmitter depending on its functionality.

7.4 Host interface (HI)

The host interface is a system-on-chip module that permits connection to the data bus of a host processor. The HI is capable of driving 16 programmable external pins which can be configured as an 8 bit parallel port for direct connection to a host processor.

The key features of the host interface are:

- 8 bit parallel port "Full-duplex" dedicated host register bank
- Dedicated Mozart™ core DSP register core bank.
- Register banks map directly into Mozart X memory space
- 3 transfer modes:
 - host command
 - Host to Mozart core DSP
 - Mozart core DSP to host
- Access protocols:
 - Software polled
 - Interrupt
 - DMA access by the Mozart core DSP core
- 2+ wait states clock cycles per transfer
- Supported instructions:
 - Data transfer between Mozart core and external host using Mozart MOVE instruction
 - Simple I/O service routine with bit addressing instructions
 - IO service using fast interrupts with MOVEP instructions.

7.5 ESSI

The ESSI peripheral enables serial-port communication between the DSP core and external devices including Codecs, DSP, microprocessors. The ESSI is capable of driving 12 programmable external pins which can be configured as GPIO ports C and D or ESSI pins.

The key features of the ESSI are:

- Independent receiver and transmitter
- Synchronous or asynchronous channel modes synchronous. Receiver and transmitter use same clock/sync asynchronous. Receiver and transmitter may use separate clock/sync up to one transmitter enabled in asynchronous channel mode.
- Up to three transmitters enabled in synchronous channel mode.
- Normal mode. One word per period.
- Network mode. Up to 32 words per period.

7.6 EOC

The Salieri extended on-chip memory interface provides access to 40 kB of on-chip memory. The Mozart core will treat this memory as if it were external. Access by off-chip expansion bus masters is permitted. All accesses to the extended on-chip RAM are controlled by the extended on-chip memory control register. This register determines which combinations of the Address attribute pins should be interpreted as accesses to the 40 kB of RAM.

7.7 Timers and watchdog block

The timers and watchdog block consists of a common 21-bit prescaler and three independent and identical general-purpose 24-bit timer/event counters, each with its own register set.

Each timer has the following capabilities:

- Uses internal or external clocking.
- Interrupts the Mozart after a specified number of events (clocks).
- Signals an external device after counting internal events.
- Triggers DMA transfers after a specified number of events (clocks) occurs.
- Connects to the external world through designated pins TIO[0-2] for timers 0-2.

When TIO is configured as an

- Input: timer functions as an external event counter. Timer measures external pulse width/signal period.
- Output: timer functions as a:
 - Timer
 - Watchdog timer
 - Pulse-width modulator.

7.8 PLL

The PLL generates the following clocks:

- DCLK: DSP core clock
- DACLK: ADC and DAC clock
- LRCLK: left/right clock for the SAI and the CODEC
- SCLK: shift serial clock for the SAI and the CODEC

7.9 CODEC cell

The main features of the CODEC cell are listed below:

- 20 bits stereo DAC, and 18 bits ADC
- I²S format
- Oversampling ratio: 512
- Sampling rates of 8 kHz to 48 kHz

The analog interface is in the form of differential signals for each channel. The interface on the digital side has the form of an SAI interface and can interface directly to an SAI channel and then to the DSP core.

DCLK can be supplied either by the internal PLL or by external, to allow synchronization with external anal digital sources.

8 Package information

In order to meet environmental requirements, ST offers these devices in different grades of ECOPACK® packages, depending on their level of environmental compliance. ECOPACK® specifications, grade definitions and product status are available at: www.st.com.

ECOPACK® is an ST trademark.

Figure 3. TQFP144 mechanical data and package dimensions

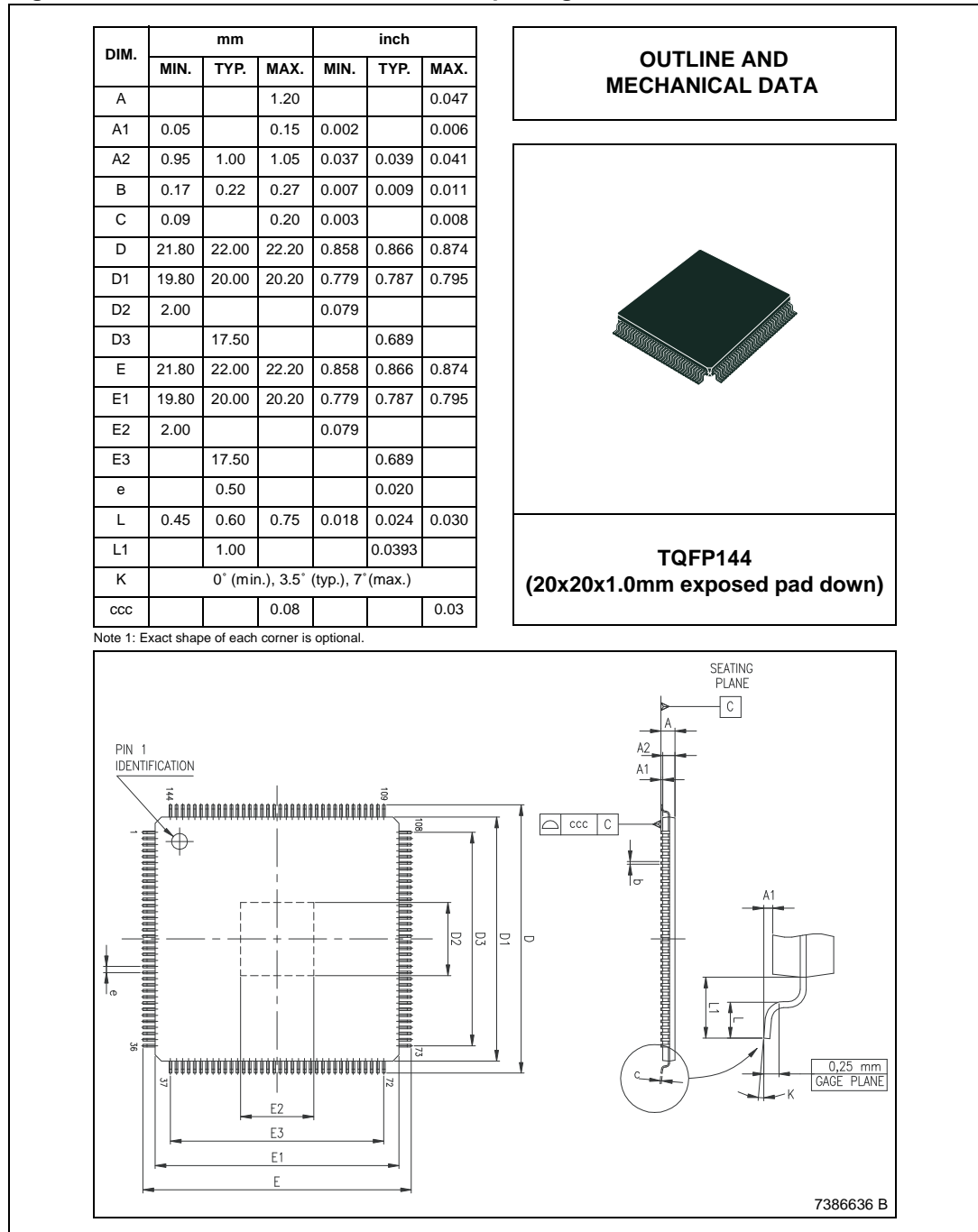

```

IPR_P      EQU      $FFFFFFE      ; Interrupt Priority Register Peripheral

; SAI interrupt Vectors
SAI_ROF    EQU      $070          ; Receiver Overflow
SAI_TUF    EQU      $072          ; Transmitter Underflow
SAI_RDR    EQU      $074          ; Receiver Data Ready
SAI_TDE    EQU      $076          ; Transmitter Data Empty

; Timer interrupt Vector
Timer0_tcf equ      $24           ; Timer0 Compare
Timer0_tof equ      $26           ; Timer0 Overflow
Timer1_tcf equ      $28           ; Timer1 Compare
Timer1_tof equ      $2A           ; Timer1 Overflow
Timer2_tcf equ      $2C           ; Timer2 Compare
Timer2_tof equ      $2E           ; Timer2 Overflow

; SCI Interrupt Vectors
SCI_REC    EQU      $000050       ; SCI receive data
SCI_REC_E  EQU      $000052       ; SCI receive data with exception status
SCI_TRANS  EQU      $000054       ; SCI transmit data
SCI_IDLE   EQU      $000056       ; SCI idle line
SCI_TIMER  EQU      $000058       ; SCI timer

;;; Bit Definition for SCI_SSR
FRAMING    EQU      6

RESET      EQU      $000000       ; Reset address location

;-----
;          EQUATES for SAI (y memory)
;-----
SAI_RCS    EQU      $FFFFFFF       ; SAI Receive Control/Status Register
SAI_RX2    EQU      $FFFFFFE       ; SAI Channel 2 Receiver Data
SAI_RX1    EQU      $FFFFFFD       ; SAI Channel 1 Receiver Data
SAI_RX0    EQU      $FFFFFFC       ; SAI Channel 0 Receiver Data
SAI_TCS    EQU      $FFFFFFB       ; SAI Transmit Control/Status Register
SAI_TX2    EQU      $FFFFFFA       ; SAI Channel 2 Transmitter Data
SAI_TX1    EQU      $FFFFFF9       ; SAI Channel 1 Transmitter Data
SAI_TX0    EQU      $FFFFFF8       ; SAI Channel 0 Transmitter Data

;;; Bit Definitions for M_RCS
ROFCL      EQU      16             ; Receiver Data Overflow Clear
RDR        EQU      15             ; Receiver Data Ready
ROFL       EQU      14             ; Receiver Data Overflow
;Reserved
RXIE       EQU      12             ; Receiver Interrupt Enable
RDWJ       EQU      11             ; Receiver Data Word Justification
RREL       EQU      10             ; Receiver Relative Timing
RCKP       EQU      9              ; Receiver Clock Polarity
RLRS       EQU      8              ; Receiver Left Right Selection
RDIR       EQU      7              ; Receiver Data Shift Direction
RWL1       EQU      6              ; Receiver Word Length Control 1
RWL0       EQU      5              ; Receiver Word Length Control 0
;Reserved
RMME       EQU      3              ; Receiver Master Mode Enable
R2EN       EQU      2              ; Receiver 2 enable
R1EN       EQU      1              ; Receiver 1 enable
ROEN       EQU      0              ; Receiver 0 enable

```

```

;;; Bit Definitions for M_TCS
TUFCL      EQU    16      ; Transmitter Data Overflow Clear
TDE        EQU    15      ; Transmitter Data Ready
TUFL       EQU    14      ; Transmitter Data Overflow
;Reserved
TXIE       EQU    12      ; Transmitter Interrupt Enable
TDWE       EQU    11      ; Transmitter Data Word Justification
TREL       EQU    10      ; Transmitter Relative Timing
TCKP       EQU    9       ; Transmitter Clock Polarity
TLRS       EQU    8       ; Transmitter Left Right Selection
TDIR       EQU    7       ; Transmitter Data Shift Direction
TWL1       EQU    6       ; Transmitter Word Length Control 1
TWL0       EQU    5       ; Transmitter Word Length Control 0
;Reserved
TMME       EQU    3       ; Transmitter Master Mode Enable
T2EN       EQU    2       ; Transmitter 2 enable
T1EN       EQU    1       ; Transmitter 1 enable
TOEN       EQU    0       ; Transmitter 0 enable

;-----
;          EQUATES for CODEC
;-----
CODEC_CSR  EQU    $FFFFCB  ; CODEC Control Register Address

;;; Bit Definitions for CODEC
GADCL_0    EQU    0       ; ADC Left Gain Bit 0
GADCL_1    EQU    1       ; ADC Left Gain Bit 1
GADCL_2    EQU    2       ; ADC Left Gain Bit 2
GADCR_0    EQU    3       ; ADC Right Gain Bit 0
GADCR_1    EQU    4       ; ADC Right Gain Bit 1
GADCR_2    EQU    5       ; ADC Right Gain Bit 2
GDACL_0    EQU    6       ; DAC Left Gain Bit 0
GDACL_1    EQU    7       ; DAC Left Gain Bit 1
GDACL_2    EQU    8       ; DAC Left Gain Bit 2
GDACR_0    EQU    9       ; DAC Right Gain Bit 0
GDACR_1    EQU    10      ; DAC Right Gain Bit 1
GDACR_2    EQU    11      ; DAC Right Gain Bit 2
MUTEDAC    EQU    12      ; Mute DAC - Active Hi, Reset Val = 1
PDNDAC     EQU    13      ; Power down DAC - Active Hi, Reset Val = 0
PDNADC     EQU    14      ; Power down ADC - Active Hi, Reset Val = 0
N_RST      EQU    15      ; Asynchronous Reset - Active Lo, Reset Val = 1

;-----
;          EQUATES for PLL
;-----
PLL_CSR    EQU    $FFFFD7  ; PLL Control/Status Register
PLL_FCR    EQU    $FFFFD6  ; PLL Fractional Register
PLL_CLKCTL EQU    $FFFFD5  ; PLL Clock Control Register

;;; Bit Definitions for PLL_CSR
IDF0       EQU    0       ; Input Divide Factor 0
IDF1       EQU    1       ; Input Divide Factor 1
IDF2       EQU    2       ; Input Divide Factor 2
IDF3       EQU    3       ; Input Divide Factor 3
IDF4       EQU    4       ; Input Divide Factor 4
; Reserved

```

```

LOCK      EQU    6      ; PLL Lock Indication bit
OUTLOCK   EQU    7      ; PLL Lost Lock bit
MF0       EQU    8      ; Multiplication bit 0
MF1       EQU    9      ; Multiplication bit 1
MF2       EQU    10     ; Multiplication bit 2
MF3       EQU    11     ; Multiplication bit 3
MF4       EQU    12     ; Multiplication bit 4
MF5       EQU    13     ; Multiplication bit 5
MF6       EQU    14     ; Multiplication bit 6
PLLIE     EQU    15     ; PLL interrupt enable
PWRDN     EQU    16     ; PLL power down
DITEN     EQU    17     ; Dither Enable
FRACEN    EQU    18     ; PLL Fractional-N function enable
PEN       EQU    19     ; PLL Enable

;;; Bit Definitions for PLL_CLKCNTL
DSPPDF0   EQU    0      ; DSP clock divider factor 0
DSPPDF1   EQU    1      ; DSP clock divider factor 1
DSPPDF2   EQU    2      ; DSP clock divider factor 2
DSPPDF3   EQU    3      ; DSP clock divider factor 3
; Reserved
DCKSRC    EQU    6      ; DSP clock source 0->XTI/(DSPPDF3:0 + 1)
;                               1->VCO/(DSPPDF3:0 + 1)
DACLKEN   EQU    7      ; Enable bit for oversampling clock
MFSDF0    EQU    8      ; Oversampling multiple bit 0
MFSDF1    EQU    9      ; Oversampling multiple bit 1
MFSDF2    EQU    10     ; Oversampling multiple bit 2
MFSDF3    EQU    11     ; Oversampling multiple bit 3
MFSDF4    EQU    12     ; Oversampling multiple bit 4
MFSDF5    EQU    13     ; Oversampling multiple bit 5
MFSDF6    EQU    14     ; Oversampling multiple bit 6
SEL0      EQU    15     ; Sampling multiple select bit 0
SEL1      EQU    16     ; Sampling multiple select bit 1
SEL2      EQU    17     ; Sampling multiple select bit 2
DSP_XTI   EQU    18     ; DSP_XTI =0 -> Use VCO/DSPPDF for DCLK
;                               DSP_XTI =1 -> Use XTI for DCLK
DAC_SEL   EQU    19     ; Selects between VCO and ext_dac_clk
XTLD      EQU    20     ; Disables the external crystal when set

;-----
;           EQUATES for I/O Port Programming
;-----

;           Register Addresses
HDR        EQU    $FFFFC9 ; PS- Host port GPIO data Register
HDDR      EQU    $FFFFC8 ; PS- Host port GPIO direction Register
PCRC      EQU    $FFFFBF ; Port C Control Register
PRRC      EQU    $FFFFBE ; Port C Direction Register
PDRC      EQU    $FFFFBD ; Port C GPIO Data Register
PCRD      EQU    $FFFFAF ; Port D Control register
PRRD      EQU    $FFFFAE ; Port D Direction Data Register
PDRD      EQU    $FFFFAD ; Port D GPIO Data Register
PCRE      EQU    $FFFF9F ; Port E Control register
PRRE      EQU    $FFFF9E ; Port E Direction Register
PDRE      EQU    $FFFF9D ; Port E Data Register
OGDB      EQU    $FFFFFC ; OnCE GDB Register

```

```

;-----
;           EQUATES for GPIOs
;-----
;;; Register Addresses
GPIOCTRL   EQU   $FFFFc4       ; Host Port Control Register
GPIODIR    EQU   $FFFFc8       ; GPIODIR register.(HI - HDDR)
GPIODAT    EQU   $FFFFc9       ; GPIODAT register.(HI - HDR)

;;; Bit Definitions for GPIO Direction Register
GPIO0_DIR  EQU   $0
GPIO1_DIR  EQU   $1
GPIO2_DIR  EQU   $2
GPIO3_DIR  EQU   $3
GPIO4_DIR  EQU   $4
GPIO5_DIR  EQU   $5
GPIO6_DIR  EQU   $6
GPIO7_DIR  EQU   $7
GPIO8_DIR  EQU   $8

;;; Bit Definitions for GPIO Data Register
GPIO0_DAT  EQU   $0
GPIO1_DAT  EQU   $1
GPIO2_DAT  EQU   $2
GPIO3_DAT  EQU   $3
GPIO4_DAT  EQU   $4
GPIO5_DAT  EQU   $5
GPIO6_DAT  EQU   $6
GPIO7_DAT  EQU   $7
GPIO8_DAT  EQU   $8

;-----
;           EQUATES for Timer
;-----

M_TCSR0    EQU   $FFFFF8F       ;Timer 0 Control/Status Register (TCSR0)
M_TLR0     EQU   $FFFFF8E       ;Timer 0 Load Register (TLR0)
M_TCPR0    EQU   $FFFFF8D       ;Timer 0 Compare Register (TCPR0)
M_TCR0     EQU   $FFFFF8C       ;Timer 0 Count Register (TCR0)
M_TCSR1    EQU   $FFFFF8B       ;Timer 1 Control/Status Register (TCSR1)
M_TLR1     EQU   $FFFFF8A       ;Timer 1 Load Register (TLR1)
M_TCPR1    EQU   $FFFFF89       ;Timer 1 Compare Register (TCPR1)
M_TCR1     EQU   $FFFFF88       ;Timer 1 Count Register (TCR1)
M_TCSR2    EQU   $FFFFF87       ;Timer 2 Control/Status Register (TCSR2)
M_TLR2     EQU   $FFFFF86       ;Timer 2 Load Register (TLR2)
M_TCPR2    EQU   $FFFFF85       ;Timer 2 Compare Register (TCPR2)
M_TCR2     EQU   $FFFFF84       ;Timer 2 Count Register (TCR2)
M_TPLR     EQU   $FFFFF83       ;Timer Prescaler Load Register (TPLR)
M_TPCR     EQU   $FFFFF82       ;Timer Prescaler Count Register (TPCR)

;-----
;
;           EQUATES for Enhanced Synchronous Serial Interface (ESSI)
;
;-----
;ESSI 0 interrupt equates
essi0_rdf  equ   $30
essi0_roe  equ   $32
essi0_rls  equ   $34

```

```

essi0_tde equ $36
essi0_tue equ $38
essi0_tls equ $3a

;ESSI 1 interrupt equates
ess1_rdf equ $40
ess1_roe equ $42
ess1_rls equ $44
ess1_tde equ $46
ess1_tue equ $48
ess1_tls equ $4a

;Register Addresses of ESSI0
M_TX00 EQU $FFFFBC ; SSI0 Transmit Data Register 0
M_TX01 EQU $FFFFBB ; SSI0 Transmit Data Register 1
M_TX02 EQU $FFFFBA ; SSI0 Transmit Data Register 2
M_TSR0 EQU $FFFFB9 ; SSI0 Time Slot Register
M_RX0 EQU $FFFFB8 ; SSI0 Receive Data Register
M_SISR0 EQU $FFFFB7 ; SSI0 Status Register
M_CRB0 EQU $FFFFB6 ; SSI0 Control Register B
M_CRA0 EQU $FFFFB5 ; SSI0 Control Register A
M_TSMA0 EQU $FFFFB4 ; SSI0 Transmit Slot Mask Register A
M_TSMB0 EQU $FFFFB3 ; SSI0 Transmit Slot Mask Register B
M_RSMA0 EQU $FFFFB2 ; SSI0 Receive Slot Mask Register A
M_RSMB0 EQU $FFFFB1 ; SSI0 Receive Slot Mask Register B

;Register Addresses of ESSI1
M_TX10 EQU $FFFFAC ; SSI1 Transmit Data Register 0
M_TX11 EQU $FFFFAB ; SSI1 Transmit Data Register 1
M_TX12 EQU $FFFFAA ; SSI1 Transmit Data Register 2
M_TSR1 EQU $FFFFA9 ; SSI1 Time Slot Register
M_RX1 EQU $FFFFA8 ; SSI1 Receive Data Register
M_SISR1 EQU $FFFFA7 ; SSI1 Status Register
M_CRB1 EQU $FFFFA6 ; SSI1 Control Register B
M_CRA1 EQU $FFFFA5 ; SSI1 Control Register A
M_TSMA1 EQU $FFFFA4 ; SSI1 Transmit Slot Mask Register A
M_TSMB1 EQU $FFFFA3 ; SSI1 Transmit Slot Mask Register B
M_RSMA1 EQU $FFFFA2 ; SSI1 Receive Slot Mask Register A
M_RSMB1 EQU $FFFFA1 ; SSI1 Receive Slot Mask Register B

;-----
; EQUATES for SCI
;-----
PCRE_ADR EQU $FFFF9F ; Serial Port Control Register
PRRE_ADR EQU $FFFF9E ; Serial Port Direction Register
PDRE_ADR EQU $FFFF9D ; Serial Port Direction Register
SCR_ADR EQU $FFFF9C ; SCI Control Register
SCCR_ADR EQU $FFFF9B ; SCI Clock Control Register
SRXH_ADR EQU $FFFF9A ; Serial Recieve Register high
SRXM_ADR EQU $FFFF99 ; Serial Recieve Register mid
SRXL_ADR EQU $FFFF98 ; Serial Recieve Register low
STXH_ADR EQU $FFFF97 ; Serial Transmit Register high
STXM_ADR EQU $FFFF96 ; Serial Transmit Register mid
STXL_ADR EQU $FFFF95 ; Serial Transmit Register low
STXA_ADR EQU $FFFF94 ; Serial Transmit Adress Register
SSR_ADR EQU $FFFF93 ; Serial Status Register

```

```

;-----
;           EQUATES for Expansion Port
;-----
EXP_BCR     EQU    $FFFFFFB    ; Bus Control Register address
EXP_AAR0    EQU    $FFFFFF9    ; Address Attribute Register (AAR0) address
EXP_AAR1    EQU    $FFFFFF8    ; Address Attribute Register (AAR1) address
EXP_AAR2    EQU    $FFFFFF7    ; Address Attribute Register (AAR2) address
EXP_AAR3    EQU    $FFFFFF6    ; Address Attribute Register (AAR3) address
EXT_RAM_STARTEQU    $C00000

;-----
;           EQUATES for Extended Memory
;-----
EOC_ADR     EQU    $FFFFFFCA

;*****
;***** Initialisation Values *****
;*****

;-----
;           CODEC Intitialisation values
;-----
; --- INIT_CCR -----
; settings fro the CODEC Control Register
;
;           321098765432109876543210
INIT_CODEC_CSR EQU    %000000001110011011011011    ; $00E6DB DACgain = 0dB - ADCgain = +0dBdB
;
;           011 --- GADCL[0:2]
;
;           011 ----- GADCR[0:2]
;
;           011 ----- GDACL[0:2]
;
;           011 ----- GDACR[0:2]
;
;           0 ----- MUTEDAC (1=Mute)
;
;           1 ----- PDNDAC (1=pwrdown)
;
;           1 ----- PDNADC (1=pwrdown)
;
;           1 ----- NRST (0=reset)

;-----
;           SAI Intitialisation values
;-----
; --- INIT_RCS -----
; settings for the Receiver Control/Status Register
;
;           321098765432109876543210
INIT_SAI_RCS EQU    %00000000001000101001001    ; $000149
;
;           1 --- ROEN (0:Disbaled; 1:Enabled)
;
;           0 --- RIEN (0:Disbaled; 1:Enabled)
;
;           0 ---- R2EN (0:Disbaled; 1:Enabled)
;
;           1 ----- RMME (1:Master mode; 0:Slave mode)
;
;           0 ----- Reserved
;
;           10 ----- RWL[0:1] (00:16; 01:24; 10:32)
;
;           0 ----- RDIR (0:MSB 1st; 1:LSB 1st)
;
;           1 ----- RLRS (0:LRCKR=0-LW; 1:LRCKR=0-RW)
;
;           0 ----- RCKP (0:-ve ; 1:+ve)
;
;           0 ----- RREL (0:trans-1st; 1:I2S)
;
;           0 ----- RDWJ
;
;           1 ----- RXIE (0:Disabled; 1:Enabled)
;
;           0 ----- Reserved
;
;           0 ----- ROFL

```

```

;
;          0 ----- RDR
;          0 ----- ROFCL

;--- INIT_TCS -----
; settings for the Transmitter Control/Status Register
;          321098765432109876543210
INIT_SAI_TCS EQU %00000000001010101001001 ; $000549 - non incrociato
;
;          1 --- TOEN (0:Disbaled; 1:Enabled)
;          0 --- T1EN (0:Disbaled; 1:Enabled)
;          0 ---- T2EN (0:Disbaled; 1:Enabled)
;          1 ----- TMME (1:Master mode; 0:Slave mode)
;          0 ----- reserved
;          10 ----- TWL[0:1] (00:16; 01:24; 10:32)
;          0 ----- TDIR (0:MSB 1st; 1:LSB 1st)
;          1 ----- TLRS (0:LRCKR=0-LW; 1:LRCKR=0-RW)
;          0 ----- TCKP (0:-ve ; 1:+ve)
;          1 ----- TREL (0:trans-1st; 1:I2S)
;          0 ----- TDWE
;          1 ----- TXIE (0:Disabled; 1:Enabled)
;          0 ----- Reserved
;          0 ----- TUPL
;          0 ----- TDE
;          0 ----- TUFCL

;-----
;          PLL Intitialisation values
;-----
IF 1 ; Settings per sci 115200
;--- PLL_CSR -----
; settings for the PLL control register
;          321098765432109876543210
; settings for the PLL control register
;          321098765432109876543210
;INIT_PLL_CSR EQU $0E0C00
INIT_PLL_CSR EQU %000011100000110000000000 ; $0E0C00
;
;          00000 --- IDF =0 (actual = IDF+1=1)
;          0 ----- RESERVED
;          0 ----- LOCK (read only; 0:out of lock)
;          0 ----- OUTLOCK (read only; 0:in lock)
;          0001100 ----- MF =12 (actual = MF + 1 = 13)
;          0 ----- PLLIE (0:intr disable)
;          0 ----- PWRDN (1:power down mode)
;          1 ----- DITEN (0:disable)
;          1 ----- FRACTN (0:disable)
;          1 ----- PEN (1:PLL enable)

;--- FRACT -----
; settings for the Fractional N part of the PLL
;          321098765432109876543210
;INIT_PLL_FCR EQU $0034bd
INIT_PLL_FCR EQU %00000000011010010111101 ; $0034bd

;          01110000101001 --- FRACT = 13501

;--- CLKCTL -----

```

```

; settings for the clock control register
;
;          321098765432109876543210
;INIT_PLL_CLKCTL EQU    $018cc1
INIT_PLL_CLKCTL EQU    %000000011000001011000001    ; $018cc1
;
;          0001 --- DSPDF =1 (actual = DSPDF+1=3)
;
;          00 ----- TESTSEL
;
;          1 ----- DCKSRC (0:XTI; 1:FVCO)
;
;          1 ----- DACLKEN (1: enable CODEC clocks)
;
;          0000010 ----- MFSDF =2 (actual =MFSDF+1 = 3 )
;
;          011 ----- SEL (000:128,001:256, 010:384, etc)
;
;          0 ----- DSP_XTI (0:vco/DSPDF; 1:xti)
;
;          0 ----- DAC_SEL (0:vco/MFSDF; 1:ext_dac_clk)
;
;          0 ----- XTLD (0:Enabled; 1:Disabled)

ENDIF    ; Settings per sci 115200

;-----
;          Timer Intitialisation values
;-----
;--- TCSR0 -----
; settings for the Timer Control/Status Register
;
;          321098765432109876543210
INIT_TCSR0 EQU    %000000001000101000000100    ; $8A04    mode0 / trm=1 / tce=1 / pce=1/ dir=out
INIT_TCSR1 EQU    %000000001000101000000100    ; $8A04    mode0 / trm=1 / tce=1 / pce=1/ dir=out
INIT_TCSR2 EQU    %000000001000101000000100    ; $8A04    mode0 / trm=1 / tce=1 / pce=1/ dir=out
;
;          xx ----->[23-22]; unused
;
;          0 ----->[21]    TCF    ; Timer Compare Flag
;
;          0 ----->[20]    TOP    ; Timer Overflow Flag
;
;          xxxx ----->[19-16]    ; unused
;
;          0 ----->[15]    PCE    ; Prescaler Clock Enable
;
;          x ----->[14]    ; unused
;
;          0 ----->[13]    DO    ; Data Output
;
;          0 ----->[12]    DI    ; Data Input
;
;          1 ----->[11]    DIR    ; Direction
;
;          x ----->[10]    ; unused
;
;          1 ----->[ 9]    TRM    ; Timer Reload Mode
;
;          0 ----->[ 8]    INV    ; Inverter
;
;          0000 ----->[7-4]    Tc[3-0] ; Timer Control = Mode0
;
;          x ---->[ 3]    ; unused
;
;          1 --->[ 2]    TCIE    ; Timer Compare Interrupt Enable
;
;          0 -->[ 1]    TOIE    ; Timer Overflow Enable
;
;          0 ->[ 0]    TE    ; Timer Enable

;--- TLRO -----
; settings for the Timer Load Register
INIT_TLRO EQU    $000000
INIT_TLR1 EQU    $000000
INIT_TLR2 EQU    $000000

;--- TCPRO -----
; settings for the Timer Compare Register
;INIT_TCPRO EQU    $000002
;INIT_TCPR1 EQU    $000004
;INIT_TCPR2 EQU    $000008
INIT_TCPRO EQU    $000000
INIT_TCPR1 EQU    $000000

```

```

INIT_T CPR2 EQU 3000000

;--- TPLR -----
; settings for the clock control register
;
; 321098765432109876543210
;INIT_TPLR EQU %001000000000001111100111 ; $2003E7 source TIO0 / divider = 999+1
INIT_TPLR EQU %000000000000001111100111 ; $0003E7 source internal / prescaler 999
;
; X-----> ; Reserved. Write to zero for future compatibility.
;
; 01-----> PS[1-0] ; Prescaler Source [00 internal / 01 external TIO0 /
;
; ; 10 external TIO0 / 11 external TIO0]
;
; 00000000001000000000-> PL[20-0] ; Prescaler Preload Value200400

;-----
;
; Interrupt Initialisation Values
;-----
; settings for the Interrupt priority register - Core
;
; 321098765432109876543210
INIT_IPR_C EQU %000000000000000000000000 ; $000000

; settings for the Interrupt priority register - peripherals
;
; 321098765432109876543210
INIT_IPR_P EQU %000000000011111001000100 ; $29C4 glitch sull'uscita del dac
;
; 00---- HI
;
; 11----- ESSIO
;
; 00----- ESSI1
;
; 11----- SCI
;
; 11----- TIMER
;
; 11 ----- SAI
;
; 11 ----- CODEC
;
; 00 ----- PLL
;
; 00 ----- Unknow
;
; 00 ----- I2C
;
; 00 ----- SPI
;
; 00 ----- EMI

;-----
;
; Expansion Port Intitilisation values
;-----
;--- INIT_AAR0 -----
; settings for the Address Attribute Register1
;
; 321098765432109876543210
INIT_AAR0 EQU %11000000000010000010000 ; C00410
;
; 00 --- BAT (00: Synchronous SRAM; 01: SRAM; 10: DRAM; 11: Reserved)
;
; 0 ---- BAAP (0:AA1 active low; 1: AA1 active high)
;
; 0 ----- BPEN (0: P space disabled; 1: P space enabled)
;
; 1 ----- BXEN (0: X data space disabled; 1: X data space enabled)
;
; 0 ----- BYEN (0: Y data space disabled; 1: Y data space enabled)
;
; 0 ----- BAM (0: 8 LSB of address will appear on A0-A7;
;
; 1: 8 LSB of address will appear on A16-A23)
;
; 0 ----- BPAC (0: packing disabled; 1: packing enabled)
;
; 0100 ----- BNC (Number of bits to compare; 1111, 1110, 1101 reserved)
;
; 110000000000 ----- BAC (Address to compare; BNC most significant)
;--- INIT_BCR -----

```

```

; settings for the Bus Control Register
;
;          321098765432109876543210
INIT_BCR    EQU    %001100000010010000100001 ; 306E10
;INIT_BCR    EQU    %00000111111111100111001111 ; 30FE07
;
;          00111 --- BA0W (Area 0 wait states)
;
;          00000 ----- BA1W (Area 1 wait states)
;
;          111 ----- BA2W (Area 2 wait states)
;
;          111 ----- BA3W (Area 3 wait states)
;
;          00000 ----- BDFW (Default area wait states)
;
;          0 ----- BBS (0: ; 1: DSP is bus master READ ONLY)
;
;          0 ----- BLH (0: ; 1: BLN always asserted)
;
;          0 ----- BRH (0: ; 1: BRN always asserted)

```

```

;*****

```

```

; definitions added by Paul Cassidy for salieri testbench

```

```

TRIGGER_TUBE EQU    $12002
M_BCR        EQU    $FFFFFFB    ; Bus Control Register
M_AAR0       EQU    $FFFFFF9    ; Address Attribute 0
M_AAR1       EQU    $FFFFFF8    ; Address Attribute 1
M_AAR2       EQU    $FFFFFF7    ; Address Attribute 2
M_AAR3       EQU    $FFFFFF6    ; Address Attribute 3

```

```

;*****
;***** Main Prog Starts Here *****
;*****

```

```

startp

```

```

    org p:$0
    jmp start

```

```

sci_int

```

```

    org p:SCI_REC        ; Interrupt SCI receive
    jsr INT_SCIR
    org p:SCI_TRANS      ; Interrupt SCI transmit
    jsr INT_SCIT
    org p:SCI_REC_E      ; Interrupt SCI framing error
    jsr INT_SCIE

```

```

sai_int

```

```

    org p:SAI_RDR
    jsr INT_RDR
    org p:SAI_TDE
    jsr INT_TDE
    org p:SAI_ROF
    jsr INT_ROF
    org p:SAI_TUF
    jsr INT_TUF

```

```

essi_int

```

```

    org p:essi0_rdf
    jsr Comp_0
    nop
    org p:essi0_roe

```

```

    movep x:M_SISR0,a0
    movep x:M_RX0,y:(r0)+
    org p:essi0_rls
    nop
    nop
    org p:essi0_tde
    jsr clr_tde0
    nop
    org p:essi0_tue
    jsr clr_tue0
    nop
    org p:essi0_tls
    nop
    nop

timer_int
    org p:Timer0_tcf
    jsr INT_TMR0_tcf
    org p:Timer0_tof
    jsr INT_TMR0_tof
    org p:Timer1_tcf
    jsr INT_TMR1_tcf
    org p:Timer1_tof
    jsr INT_TMR1_tof
    org p:Timer2_tcf
    jsr INT_TMR2_tcf
    org p:Timer2_tof
    jsr INT_TMR2_tof

    org x:0
states dsm ntaps

    org y:0
coef dc .1,.3,-.1,.2

    org p:$100
start
    ; setup external memory for sync with testbench
;-----
;  Initialise Core
;-----

    clr    a
    clr    b
    move   #$0,r0
    move   #$fff,m0
    ori    #$3,mr          ; mask interrupts
    movep  #INIT_IPR_C,x:IPR_C ; set CORE interrupt priorities
    movep  #INIT_IPR_P,x:IPR_P ; set PERIPHERAL interrupt priorities

;-----
;  Initialise PLL
;-----

init_pll
    movep  #INIT_PLL_CSR,x:PLL_CSR ; enable the pll.
    jclr   #LOCK,x:<<PLL_CSR,*     ; wait for lock.

```

```

    movep  #INIT_PLL_FCR,x:PLL_FCR      ; set fract value.
    bset   #FRACEN,x:<<PLL_CSR         ; enable fractional-n operation.
    movep  #INIT_PLL_CLKCTL,x:PLL_CLKCTL ; setup the clock generation.

    IF 1
;-----
;   Initialise CODEC
;-----
init_codec
    movep  #INIT_CODEC_CSR,x:CODEC_CSR  ; initialise CODEC control/status reg

;-----
;   Initialise SAI
;-----
; The receiver and transmitter control/status register are configured the same for simplicity only.
; Master mode , 24-bit word-size , MSB first , Low word clock = left word , Neg bit-clk polarity ,
; Non i2s format , (For 32-bit words) First bit x 8 , Interrupts enabled.
init_sai
    movep  #INIT_SAI_TCS,y:SAI_TCS      ; initialise transmit control/status reg
    movep  #INIT_SAI_RCS,y:SAI_RCS      ; initialise receiver control/status reg

;-----
; Enable gpios for HI
;-----
    bset  #GPIO0_DIR,x:GPIOCTRL        ; Setup HI pin for GPIO mode
    bset  #GPIO0_DIR,x:GPIODIR         ; Setup GPIO as output
    bset  #GPIO1_DIR,x:GPIOCTRL        ; Setup HI pin for GPIO mode
    bset  #GPIO1_DIR,x:GPIODIR         ; Setup GPIO as output
    ENDIF

;-----
; Initialize ESSI0
;-----
    IF 1
init_essi
    movep  #$181801,x:M_CRA0 ; cra0_addr, 24'b010110000001100000011110
                                ; The divider control is set to 1 (2 words per frame)
                                ; for Normal mode, bits are left aligned to bit 23. Word
                                ; length is set to 24 bits.PM = 1 -> Fcore/4.

    movep  #$fc113e,x:M_CRB0 ; crb0_addr, 24'b111111000001010100111110
                                ; The receive exception and transmit exception interrupts
                                ; are enabled as are receive last slot and transmit last
                                ; slot. It is set in the synchronous normal mode. Data and
                                ; frame sync are clocked out on the rising edge of the clock.
                                ; Frame sync polarity is positive and occurs together with the
                                ; the first bit of data from the first slot. MSB is shifted
                                ; first. SC2 o/p SC1 o/p SC0 o/p

Enable_pins
;-----
    move  #01c000,x0          ;
    movep x:M_CRB0,b1        ;
    or   x0,b1                ; // Enable TX2/TX1/TX0 (ESSI 0)
    movep #$00003f,x:M_PCRC ; // ALL Pins are ESSI.
                                ; check that all pins are enabled

    rep  #05
    nop

```

```

    movep b1,x:M_CRB0

ENDIF

IF 1
;-----
; Enable gpios for TIMER
;-----

init_gpio
;   movep   #$000000,x:<<PCRC           ; ESSIO port as GPIO
;   movep   #$0000ff,x:<<PRRC           ; ESSIO port as OUT
Movep   #$000000,x:<<PCRD           ; ESSI1 port as GPIO
Movep   #$000000,x:<<PRRD           ; ESSI1 port as TIMER(INPUT)

;-----
;   Initialise Timer
;-----

init_timer
    bclr #0,x:M_TCSR0           ; Disable Timer0
    bclr #0,x:M_TCSR1           ; Disable Timer1
    bclr #0,x:M_TCSR2           ; Disable Timer2

    movep #INIT_TCSR0,x:<<M_TCSR0       ; Timer0 enable at mode 0 + reload
    movep #INIT_TPLR,x:<<M_TPLR         ; Initial value of the timer counter
    movep #INIT_TLR0,x:<<M_TLR0         ; Initial value of the timer counter
    movep #INIT_TCPR0,x:<<M_TCPR0       ; Number of CLK/2 cycles until a trigger is generated

    movep #INIT_TCSR1,x:<<M_TCSR1       ; Timer1 enable at mode 0 + reload
    movep #INIT_TPLR,x:<<M_TPLR         ; Initial value of the timer counter
    movep #INIT_TLR1,x:<<M_TLR1         ; Initial value of the timer counter
    movep #INIT_TCPR1,x:<<M_TCPR1       ; Number of CLK/2 cycles until a trigger is generated

    movep #INIT_TCSR2,x:<<M_TCSR2       ; Timer2 enable at mode 0 + reload
    movep #INIT_TPLR,x:<<M_TPLR         ; Initial value of the timer counter
    movep #INIT_TLR2,x:<<M_TLR2         ; Initial value of the timer counter
    movep #INIT_TCPR2,x:<<M_TCPR2       ; Number of CLK/2 cycles until a trigger is generated

;-----
;   Initialise Expansion Port and Flex Memory
;-----

init_expport
    movep   #INIT_AAR0,x:EXP_AAR0     ; initialise AAR0 control/status reg
    movep   #INIT_BCR,x:EXP_BCR       ; initialise BCR reg

ENDIF

;-----
;   Initialise SCI
;-----

IF 1
init_sci
    movep   #$E,x:SCCR_ADR
    movep   #$7,x:PCRE_ADR
    movep   #$11b02,x:SCR_ADR

```



```

    bset    #12,x:SCR_ADR                ; start SCI transmit
    mac     x0,y0,a    x:(r3)+,x0      y:(r4)+,y0 ; generates variations on mean value of DAC
    move    #SAAAAAA,x0
    move    x0,x:$CAAAAA                ; send data to expansion port
    move    x0,x:GPIODAT                ; move PORTB pins

    bset    #12,x:SCR_ADR                ; start SCI transmit
    mac     x0,y0,a    x:(r3)+,x0      y:(r4)+,y0 ; generates variations on mean value of DAC
    move    #S555555,x0
    move    x0,x:$C55555                ; send data to expansion port
    move    x0,x:GPIODAT                ; move PORTB pins

jmp LOOP

ENDIF

;-----
; Interrupt Service Routines
;-----

;SAI
;-----
INT_TDE                                ; The transmitter data empty flag is cleared as soon
                                        ; as the last move is performed
    Movep a,y:<<SAI_TX0                ; Load LEFT transmit data register for channel 0
    nop
    nop
    movep b,y:<<SAI_TX0                ; Load RIGHT transmit data register for channel 0
    rti

INT_RDR                                ; The receiver data ready flag is cleared as soon
                                        ; as the last move is performed
    movep y:<<SAI_RX0,a                ; Move Channel 0 received LEFT data to x-memory.
    move    a,x:(r0)
    nop
    nop
    movep y:<<SAI_RX0,b                ; Move channel 0 received RIGHT data to y-memory.
    move    b,y:(r0)+
    rti

INT_ROF
    bset    #16,y:SAI_RCS
    bclr    #16,y:SAI_RCS
    rti

INT_TUF
    bset    #16,y:SAI_TCS
    bclr    #16,y:SAI_RCS
    rti

;TIMER

```

```

;-----
INT_TMR0_tcf
;   bchg   #0,x:PDRC           ; toggle pin12 Fout=(XTI/2)/((TPLR+1)*(TCPR+1)*2)
   bchg   #13,x:M_TCSR0       ; toggle TIO0 Fout=(XTI/2)/((TPLR+1)*(TCPR+1)*2)
   nop
   rti

INT_TMR0_tof
   nop
   nop
   rti

INT_TMR1_tcf
;   bchg   #1,x:PDRC           ; toggle pin4 Fout=Fin/((TPLR+1)*(TCPR+1)*2)
   bchg   #13,x:M_TCSR1       ; toggle TIO1 Fout=(XTI/2)/((TPLR+1)*(TCPR+1)*2)
   nop
   rti

INT_TMR1_tof
   nop
   nop
   rti

INT_TMR2_tcf
;   bchg   #2,x:PDRC           ; toggle pin3 Fout=Fin/((TPLR+1)*(TCPR+1)*2)
   bchg   #13,x:M_TCSR2       ; toggle TIO2 Fout=(XTI/2)/((TPLR+1)*(TCPR+1)*2)
   nop
   rti

INT_TMR2_tof
   nop
   nop
   rti

;ESSI
;-----
clr_tde0
   movep  r1,x:M_TX00
   move   (r1)+
   movep  r1,x:M_TX01
   move   (r1)+
   movep  r1,x:M_TX02
   move   (r1)+
   rti

clr_tue0
   movep  x:M_SISR0,a0
   movep  r1,x:M_TX00
   move   (r1)+
   movep  r1,x:M_TX01
   move   (r1)+
   movep  r1,x:M_TX02
   move   (1)+
   rti

Comp_0
   rti

```

```
Clr_gpio
    bclr    #0,x:M_PDRE
    rti

Comp_1
    rti

;SCI
;-----
INT_SCIR
    move    x:SRXL_ADR,x0
    movep   #$3f02,x:SCR_ADR
;    move    x0,x:(r1)+
;    move    x0,x:$C00000
    rti

INT_SCIT
;    movep   x0,x:STXA_ADR
    movep   #$000041,x:STXA_ADR
;    movep   #$000061,x:STXA_ADR
L3
    jclr    #0,x:<<SSR_ADR,L3
    movep   #$12f02,x:SCR_ADR
    rti

INT_SCIE
    jclr    #FRAMING,x:SSR_ADR,NO_FRA
L2
    jclr    #0,x:<<SSR_ADR,L2
    movep   #$21,x:STXA_ADR
NO_FRA
    nop
    move    x:SRXL_ADR,x0
    rti
```

Revision history

Table 8. Document revision history

Date	Revision	Changes
11-Apr-2006	1	Initial release.
26-Jan-2009	2	Document status promoted from preliminary data to datasheet. Updated Section 8: Package information on page 22 .
23-Sep-2013	3	Updated Disclaimer.

Please Read Carefully:

Information in this document is provided solely in connection with ST products. STMicroelectronics NV and its subsidiaries ("ST") reserve the right to make changes, corrections, modifications or improvements, to this document, and the products and services described herein at any time, without notice.

All ST products are sold pursuant to ST's terms and conditions of sale.

Purchasers are solely responsible for the choice, selection and use of the ST products and services described herein, and ST assumes no liability whatsoever relating to the choice, selection or use of the ST products and services described herein.

No license, express or implied, by estoppel or otherwise, to any intellectual property rights is granted under this document. If any part of this document refers to any third party products or services it shall not be deemed a license grant by ST for the use of such third party products or services, or any intellectual property contained therein or considered as a warranty covering the use in any manner whatsoever of such third party products or services or any intellectual property contained therein.

UNLESS OTHERWISE SET FORTH IN ST'S TERMS AND CONDITIONS OF SALE ST DISCLAIMS ANY EXPRESS OR IMPLIED WARRANTY WITH RESPECT TO THE USE AND/OR SALE OF ST PRODUCTS INCLUDING WITHOUT LIMITATION IMPLIED WARRANTIES OF MERCHANTABILITY, FITNESS FOR A PARTICULAR PURPOSE (AND THEIR EQUIVALENTS UNDER THE LAWS OF ANY JURISDICTION), OR INFRINGEMENT OF ANY PATENT, COPYRIGHT OR OTHER INTELLECTUAL PROPERTY RIGHT.

ST PRODUCTS ARE NOT DESIGNED OR AUTHORIZED FOR USE IN: (A) SAFETY CRITICAL APPLICATIONS SUCH AS LIFE SUPPORTING, ACTIVE IMPLANTED DEVICES OR SYSTEMS WITH PRODUCT FUNCTIONAL SAFETY REQUIREMENTS; (B) AERONAUTIC APPLICATIONS; (C) AUTOMOTIVE APPLICATIONS OR ENVIRONMENTS, AND/OR (D) AEROSPACE APPLICATIONS OR ENVIRONMENTS. WHERE ST PRODUCTS ARE NOT DESIGNED FOR SUCH USE, THE PURCHASER SHALL USE PRODUCTS AT PURCHASER'S SOLE RISK, EVEN IF ST HAS BEEN INFORMED IN WRITING OF SUCH USAGE, UNLESS A PRODUCT IS EXPRESSLY DESIGNATED BY ST AS BEING INTENDED FOR "AUTOMOTIVE, AUTOMOTIVE SAFETY OR MEDICAL" INDUSTRY DOMAINS ACCORDING TO ST PRODUCT DESIGN SPECIFICATIONS. PRODUCTS FORMALLY ESCC, QML OR JAN QUALIFIED ARE DEEMED SUITABLE FOR USE IN AEROSPACE BY THE CORRESPONDING GOVERNMENTAL AGENCY.

Resale of ST products with provisions different from the statements and/or technical features set forth in this document shall immediately void any warranty granted by ST for the ST product or service described herein and shall not create or extend in any manner whatsoever, any liability of ST.

ST and the ST logo are trademarks or registered trademarks of ST in various countries.

Information in this document supersedes and replaces all information previously supplied.

The ST logo is a registered trademark of STMicroelectronics. All other names are the property of their respective owners.

© 2013 STMicroelectronics - All rights reserved

STMicroelectronics group of companies

Australia - Belgium - Brazil - Canada - China - Czech Republic - Finland - France - Germany - Hong Kong - India - Israel - Italy - Japan - Malaysia - Malta - Morocco - Philippines - Singapore - Spain - Sweden - Switzerland - United Kingdom - United States of America







www.st.com

Looking for pricing, stock, or lifecycle information?

Click below to explore more details on WIN SOURCE:

-  [View E-TDA7590TR](#) on WIN SOURCE
-  [STMicroelectronics](#) Information

Optimize Your Supply Chain with WIN SOURCE Solutions

-  Global Sourcing Solution
-  Obsolete Management
-  Cost Control Management
-  Shortage Management
-  Alternative Solution
-  Excess Inventory Management