



THE DATASHEET OF ESDCAN24-2BLY



Automotive dual-line Transil™, transient voltage suppressor (TVS) for CAN bus

Datasheet - production data

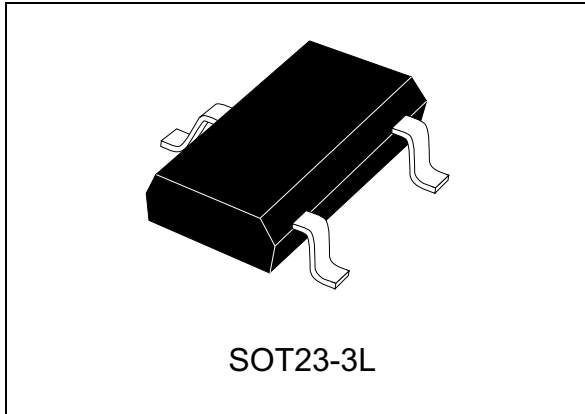

Application

Automotive controller area network (CAN) bus lines where electrostatic discharge and other transients must be suppressed.

Description

The ESDCAN01-2BLY and ESDCAN24-2BLY are dual-line Transils specifically designed for the protection of the automotive CAN bus lines against electrostatic discharge (ESD).

Features

- Dual-line ESD and EOS protection
- Breakdown voltage: V_{BR}
 - ESDCAN24-2BLY: 27 V
 - ESDCAN01-2BLY: 25 V
- Bidirectional device
- Max pulse power: 230 W (8/20 μ s)
- Low clamping factor V_{CL} / V_{BR}
- Low leakage current
- ECOPACK®2 compliant component
- AEC-Q101 qualified

Complies with the following standards

- ISO 10605 - C = 150 pF, R = 330 Ω :
 - ± 30 kV (air discharge)
 - ± 30 kV (contact discharge)
- ISO 10605 - C = 330 pF, R = 330 Ω :
 - ± 30 kV (air discharge)
 - ± 30 kV (contact discharge)
- ISO 7637-3:
 - Pulse 3a: $V_s = -150$ V
 - Pulse 3b: $V_s = +100$ V

Figure 1. Functional schematic

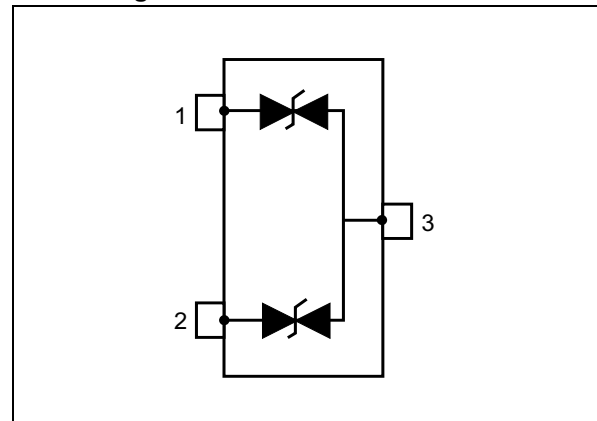

TM: Transil is a trademark of STMicroelectronics

1 Characteristics

Table 1. Absolute maximum ratings ($T_{amb} = 25^{\circ}\text{C}$)

Symbol	Parameter		Value	Unit
V_{PP}	Peak pulse voltage	ISO 10605 - C = 150 pF, R = 330 Ω :		kV
		Contact discharge	30	
		Air discharge	30	
		ISO 10605 - C = 330 pF, R = 330 Ω :		
		Contact discharge	30	
		Air discharge	30	
		HBM MIL STD 883	10	
P_{PP}	Peak pulse power dissipation (8/20 μs)	T_j initial = T_{amb}	230	W
I_{PP}	Peak pulse current (8/20 μs)		5.5	A
T_j	Operating junction temperature range		-40 to +150	$^{\circ}\text{C}$
T_{stg}	Storage temperature range		-55 to +150	$^{\circ}\text{C}$

Figure 2. Electrical characteristics (definitions)

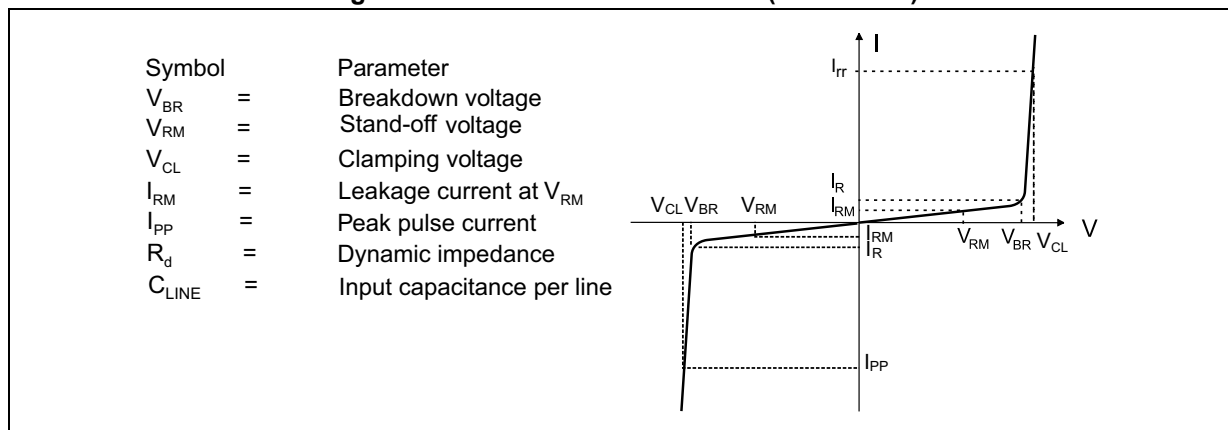

Table 2. Electrical characteristics (values, $T_{amb} = 25^{\circ}\text{C}$)

Order code	I_{RM} max at V_{RM}		V_{BR} at I_R			V_{CL} Pulse ISO7637-3		V_{CL} at I_{PP} (8/20 μs)		C		ΔC (1)	$\alpha T^{(2)}$
			min.	max.		3a at -150 V	3b at +100 V	max.		typ.	max.		
	μA	V	V	V	mA	V	V	V	A	pF	pF	pF	$10^{-4}/^{\circ}\text{C}$
ESDCAN24-2BLY	0.1	24	27	32	1	-40	40	43	5	-	30	0.1	9
ESDCAN01-2BLY	0.1	24	25	30	1	-35	35	40	5	-	30	0.1	9

1. ΔC : capacitance variation between IO1 and IO2 versus GND

2. $\Delta V_{BR} = \alpha T \times (T_{amb} - 25) \times V_{BR}(25^{\circ}\text{C})$



Figure 3. Response to ISO 7637-3 Pulse 3a (Us = -150 V) ESDCAN24-2BLY

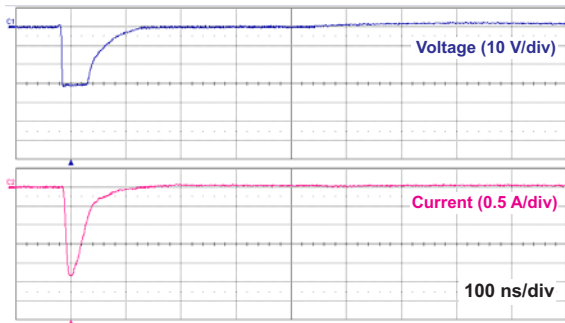

Figure 4. Response to ISO 7637-3 Pulse 3b (Us = +100 V) ESDCAN24-2BLY

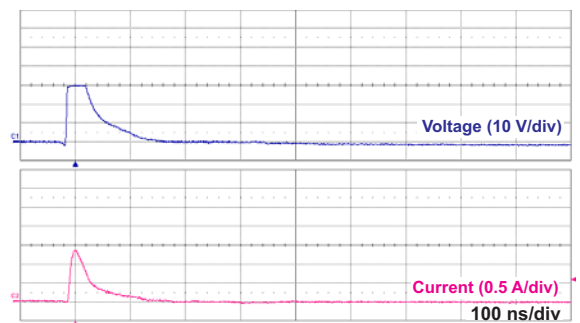

Figure 5. Response to ISO 7637-3 Pulse 3a (Us = -150 V) ESDCAN01-2BLY

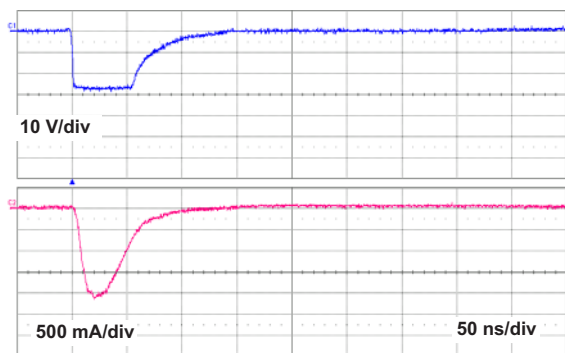

Figure 6. Response to ISO 7637-3 Pulse 3b (Us = +100 V) ESDCAN01-2BLY

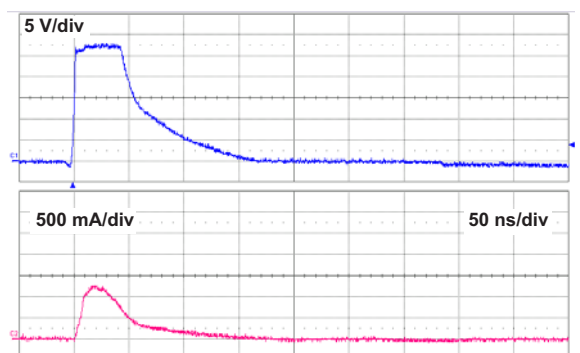

Figure 7. Peak pulse current versus clamping voltage - ESDCAN24-2BLY

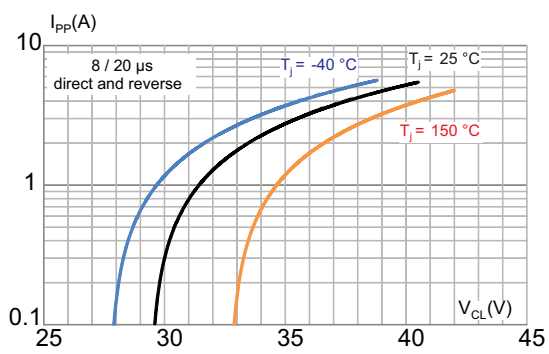
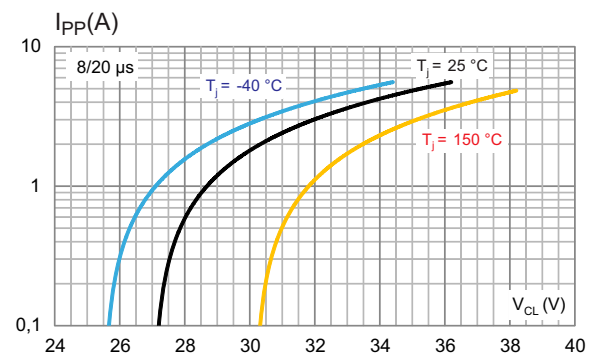

Figure 8. Clamping voltage versus peak pulse current - ESDCAN01-2BLY



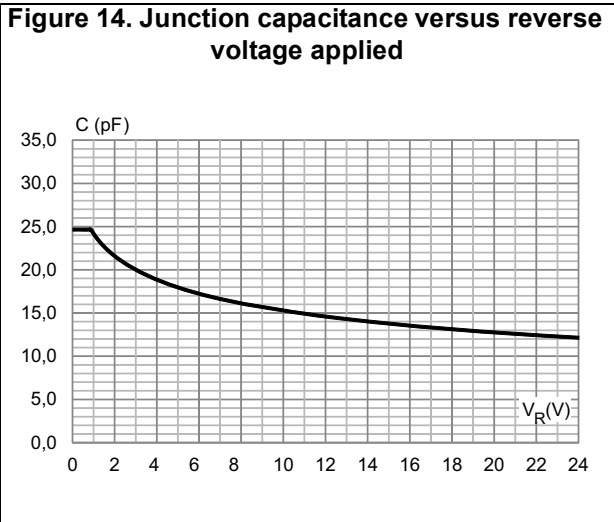
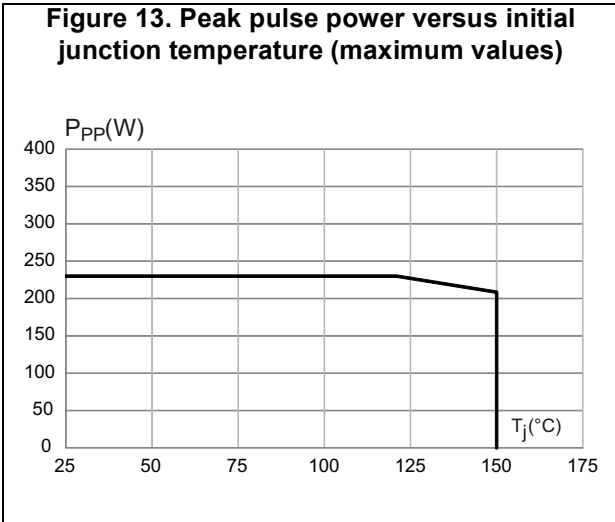
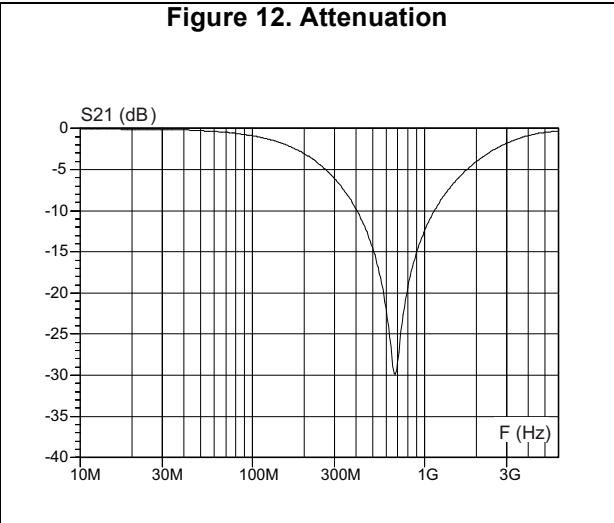
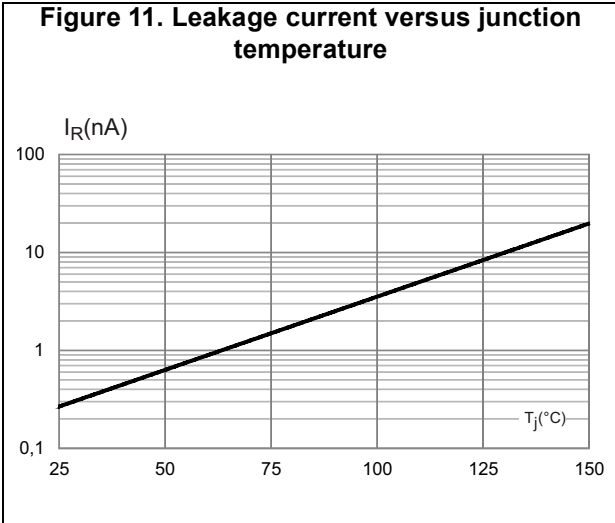
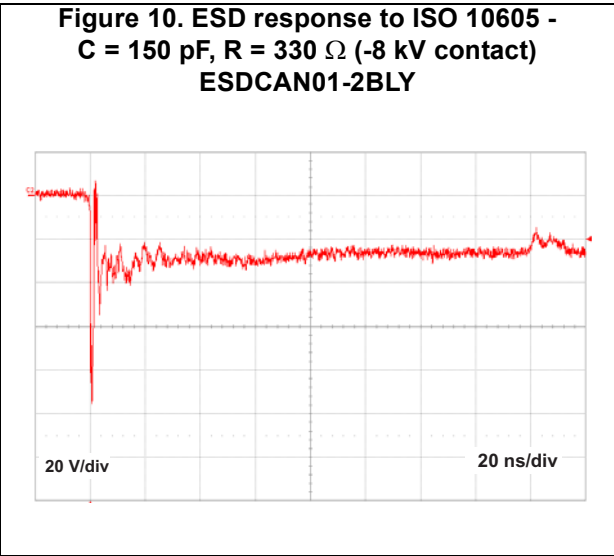
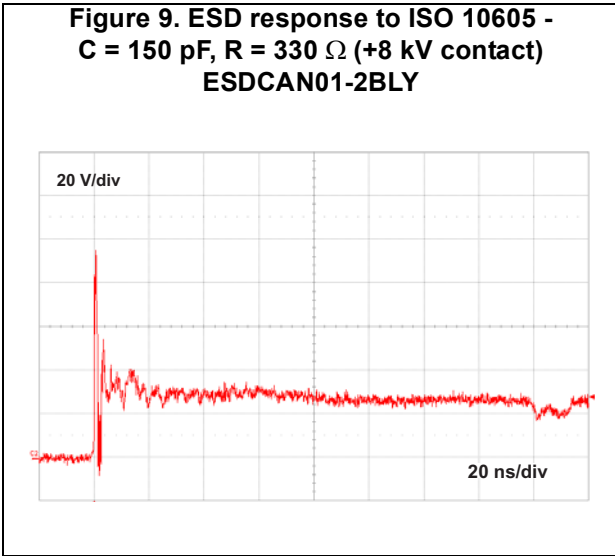

Figure 15. Peak pulse power versus exponential pulse (maximum values)

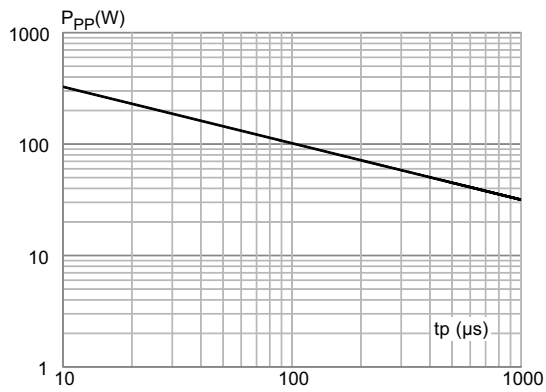
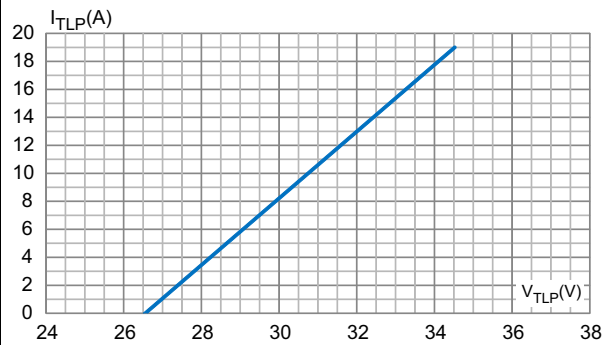

Figure 16. TLP measurements ESDCAN01-2BLY



2 Package information

- Epoxy meets UL94, V0
- Lead-free packages

In order to meet environmental requirements, ST offers these devices in different grades of ECOPACK[®] packages, depending on their level of environmental compliance. ECOPACK[®] specifications, grade definitions and product status are available at: www.st.com. ECOPACK[®] is an ST trademark.

2.1 SOT23-3L package information

Figure 17. SOT23-3L package outline

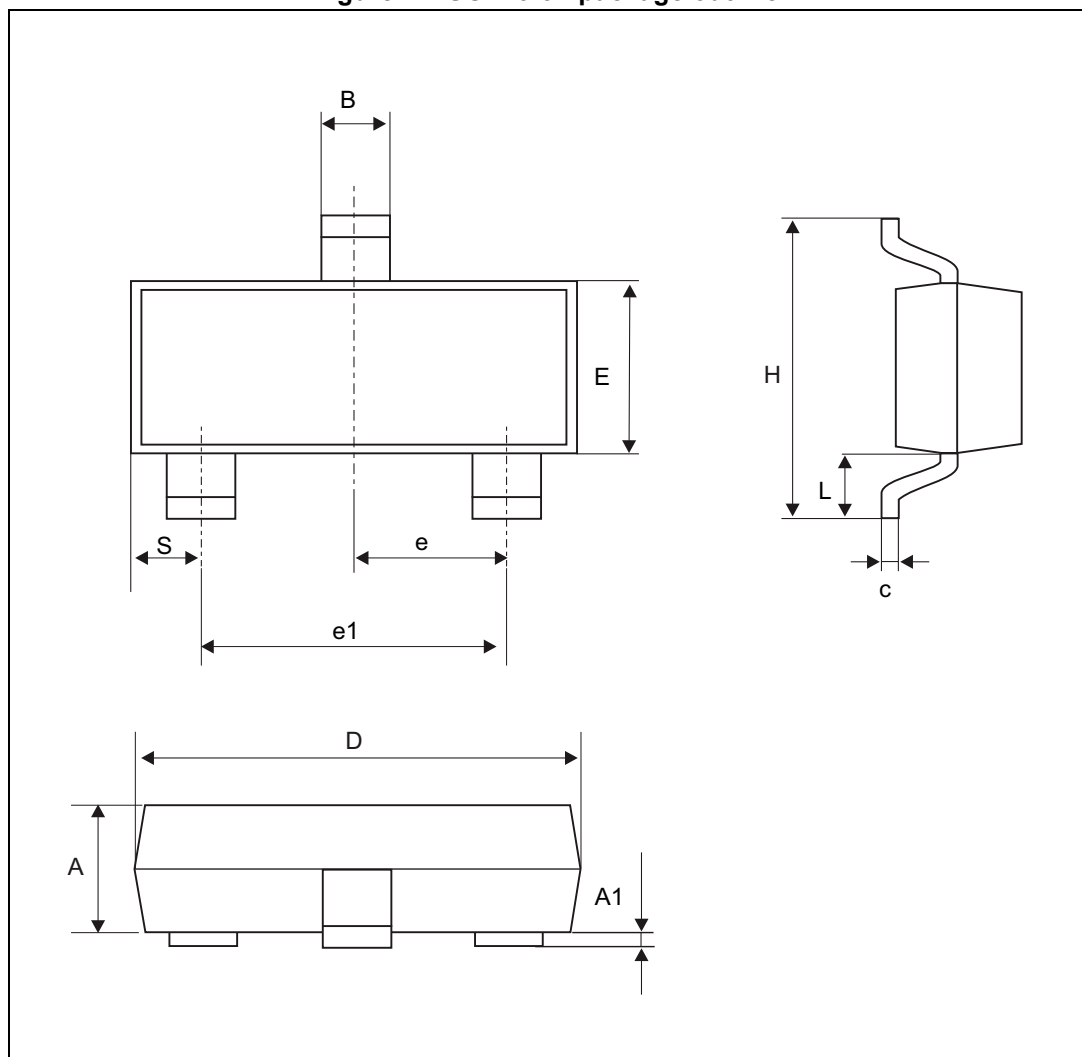

1. The marking codes can be rotated by 90° or 180° to differentiate assembly location. In no case should this product marking be used to orient the component for its placement on a PCB. Only pin 1 mark is to be used for this purpose.

Table 3. SOT23-3L package mechanical data

Ref.	Dimensions			
	Millimeters		Inches	
	Min.	Max.	Min.	Max.
A	0.89	1.4	0.035	0.055
A1	0	0.1	0	0.004
B	0.3	0.51	0.012	0.02
C	0.085	0.18	0.003	0.007
D	2.75	3.04	0.108	0.12
e	0.85	1.05	0.033	0.041
e1	1.7	2.1	0.067	0.083
E	1.2	1.75	0.047	0.069
H	2.1	3.00	0.083	0.118
L	0.6 typ.		0.024 typ.	
S	0.35	0.65	0.013	0.026

Figure 18. Footprint (dimensions in mm)

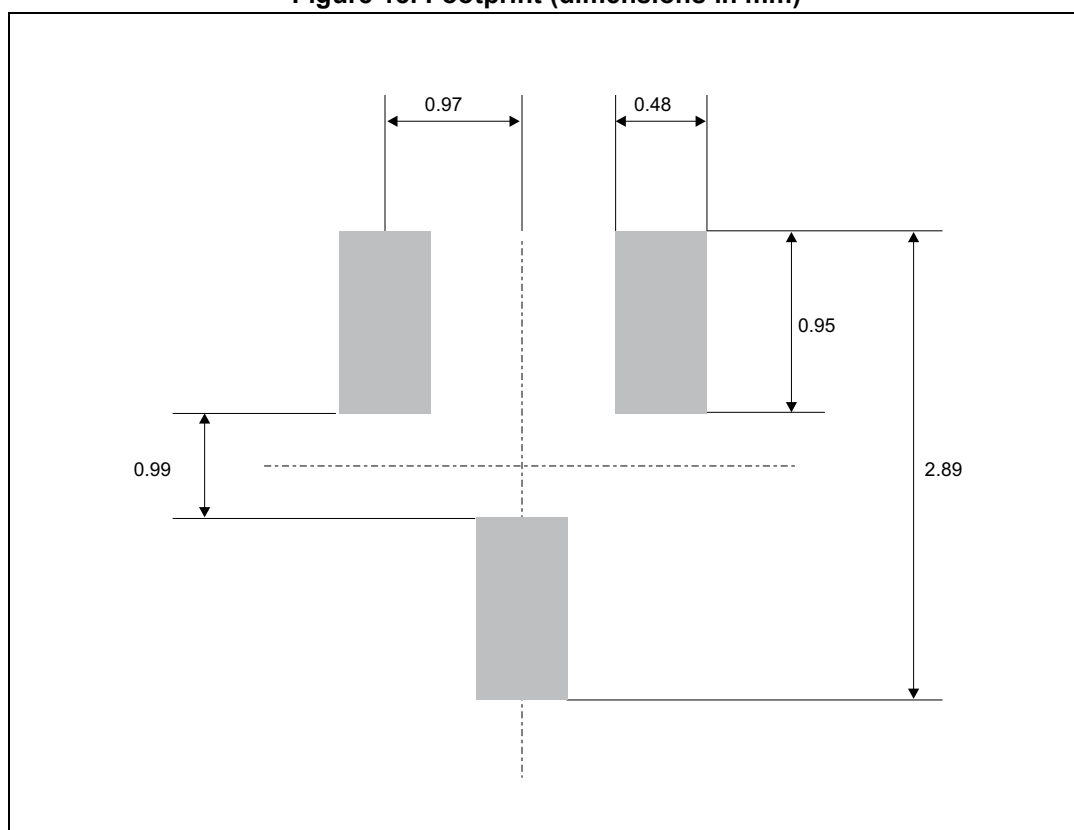

2.2 PCB design preference

1. To control the solder paste amount, the closed via is recommended instead of open vias.
2. The position of tracks and open vias in the solder area should be well balanced. The symmetrical layout is recommended, in case any tilt phenomena caused by asymmetrical solder paste amount due to the solder flow away.

2.3 Reflow profile.

Figure 19. ST ECOPACK® recommended soldering reflow profile for PCB mounting

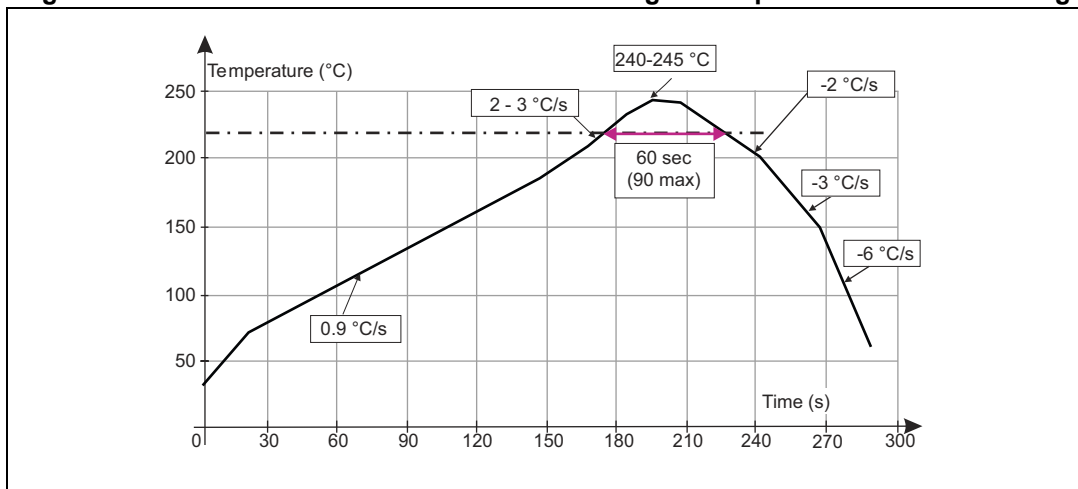

Minimize air convection currents in the reflow oven to avoid component movement.
Maximum soldering profile corresponds to the latest IPC/JEDEC J-STD-020.

3 Ordering information

Figure 20. Ordering information scheme

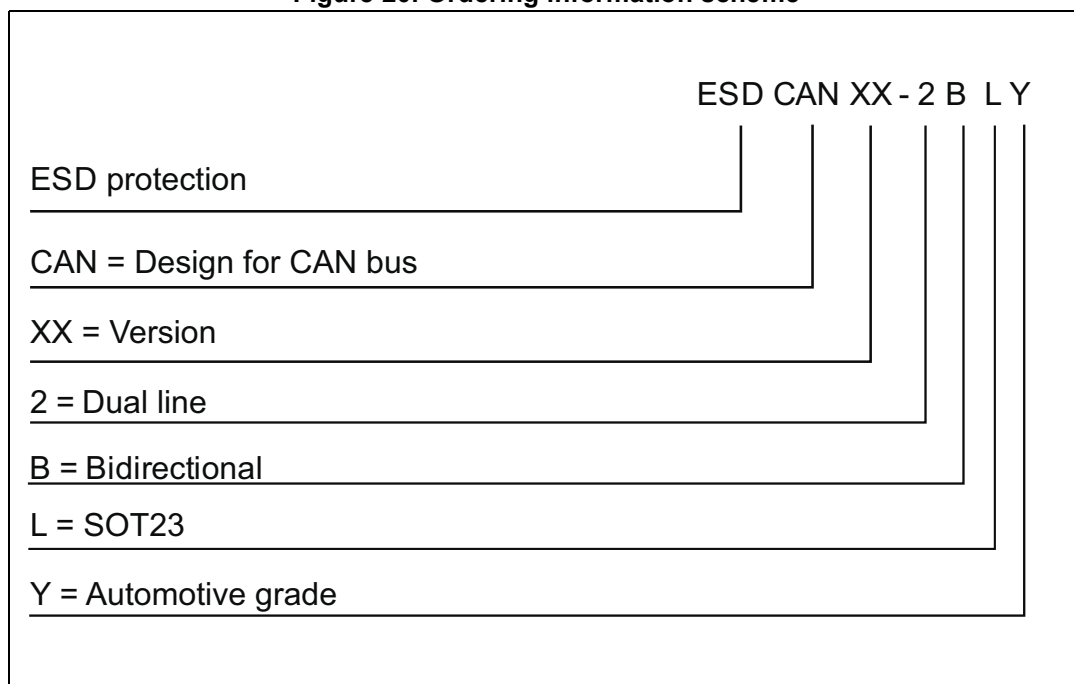

Table 4. Ordering information

Order code	Marking	Package	Weight	Base qty	Delivery mode
ESDCAN24-2BLY	EL24	SOT23-3L	9.794 mg	3000	Tape and reel
ESDCAN01-2BLY	EN24	SOT23-3L	9.794 mg	3000	Tape and reel

4 Revision history

Table 5. Document revision history

Date	Revision	Changes
13-Jul-2015	1	First issue.

IMPORTANT NOTICE – PLEASE READ CAREFULLY

STMicroelectronics NV and its subsidiaries (“ST”) reserve the right to make changes, corrections, enhancements, modifications, and improvements to ST products and/or to this document at any time without notice. Purchasers should obtain the latest relevant information on ST products before placing orders. ST products are sold pursuant to ST’s terms and conditions of sale in place at the time of order acknowledgement.

Purchasers are solely responsible for the choice, selection, and use of ST products and ST assumes no liability for application assistance or the design of Purchasers’ products.

No license, express or implied, to any intellectual property right is granted by ST herein.

Resale of ST products with provisions different from the information set forth herein shall void any warranty granted by ST for such product.



ST and the ST logo are trademarks of ST. All other product or service names are the property of their respective owners.

Information in this document supersedes and replaces information previously supplied in any prior versions of this document.

© 2015 STMicroelectronics – All rights reserved

Looking for pricing, stock, or lifecycle information?

Click below to explore more details on WIN SOURCE:

-  [View ESDCAN24-2BLY on WIN SOURCE](#)
-  [STMicroelectronics Information](#)

Optimize Your Supply Chain with WIN SOURCE Solutions

-  Global Sourcing Solution
-  Obsolete Management
-  Cost Control Management
-  Shortage Management
-  Alternative Solution
-  Excess Inventory Management