



**THE DATASHEET OF  
ESD5V3U4U-HDMI E6327**



# TVS Diode

Transient Voltage Suppressor Diode

## ESD5V3U4U-HDMI

Uni-directional Ultra-low Capacitance ESD / Transient Protection Array

ESD5V3U4U-HDMI

## Data Sheet

Revision 1.1, 2012-07-03  
Final

**Edition 2012-07-03**

**Published by  
Infineon Technologies AG  
81726 Munich, Germany**

**© 2012 Infineon Technologies AG  
All Rights Reserved.**

### **Legal Disclaimer**

The information given in this document shall in no event be regarded as a guarantee of conditions or characteristics. With respect to any examples or hints given herein, any typical values stated herein and/or any information regarding the application of the device, Infineon Technologies hereby disclaims any and all warranties and liabilities of any kind, including without limitation, warranties of non-infringement of intellectual property rights of any third party.

### **Information**

For further information on technology, delivery terms and conditions and prices, please contact the nearest Infineon Technologies Office ([www.infineon.com](http://www.infineon.com)).

### **Warnings**

Due to technical requirements, components may contain dangerous substances. For information on the types in question, please contact the nearest Infineon Technologies Office.

Infineon Technologies components may be used in life-support devices or systems only with the express written approval of Infineon Technologies, if a failure of such components can reasonably be expected to cause the failure of that life-support device or system or to affect the safety or effectiveness of that device or system. Life support devices or systems are intended to be implanted in the human body or to support and/or maintain and sustain and/or protect human life. If they fail, it is reasonable to assume that the health of the user or other persons may be endangered.

**Revision History Revision 1.0, 2012-06-30**

Page or Item	Subjects (major changes since previous revision)
<b>Revision 1.1, 2012-07-03</b>	
7	<a href="#">Figure 2-1</a>

**Trademarks of Infineon Technologies AG**

AURIX™, BlueMoon™, C166™, CanPAK™, CIPOS™, CIPURSE™, COMNEON™, EconoPACK™, CoolMOS™, CoolSET™, CORECONTROL™, CROSSAVE™, DAVE™, EasyPIM™, EconoBRIDGE™, EconoDUAL™, EconoPIM™, EiceDRIVER™, eupec™, FCOS™, HITFET™, HybridPACK™, I<sup>2</sup>RF™, ISOFACE™, IsoPACK™, MIPAQ™, ModSTACK™, my-d™, NovalithIC™, OmniTune™, OptiMOS™, ORIGA™, PRIMARION™, PrimePACK™, PrimeSTACK™, PRO-SIL™, PROFET™, RASIC™, ReverSave™, SatRIC™, SIEGET™, SINDRION™, SIPMOS™, SMARTi™, SmartLEWIS™, SOLID FLASH™, TEMPFET™, thinQ!™, TRENCHSTOP™, TriCore™, X-GOLD™, X-PMU™, XMM™, XPOSYS™.

**Other Trademarks**

Advance Design System™ (ADS) of Agilent Technologies, AMBA™, ARM™, MULTI-ICE™, KEIL™, PRIMECELL™, REALVIEW™, THUMB™, μVision™ of ARM Limited, UK. AUTOSAR™ is licensed by AUTOSAR development partnership. Bluetooth™ of Bluetooth SIG Inc. CAT-ig™ of DECT Forum. COLOSSUS™, FirstGPS™ of Trimble Navigation Ltd. EMV™ of EMVCo, LLC (Visa Holdings Inc.). EPCOS™ of Epcos AG. FLEXGO™ of Microsoft Corporation. FlexRay™ is licensed by FlexRay Consortium. HYPERTERMINAL™ of Hilgraeve Incorporated. IEC™ of Commission Electrotechnique Internationale. IrDA™ of Infrared Data Association Corporation. ISO™ of INTERNATIONAL ORGANIZATION FOR STANDARDIZATION. MATLAB™ of MathWorks, Inc. MAXIM™ of Maxim Integrated Products, Inc. MICROTEC™, NUCLEUS™ of Mentor Graphics Corporation. Mifare™ of NXP. MIPI™ of MIPI Alliance, Inc. MIPS™ of MIPS Technologies, Inc., USA. muRata™ of MURATA MANUFACTURING CO., MICROWAVE OFFICE™ (MWO) of Applied Wave Research Inc., OmniVision™ of OmniVision Technologies, Inc. Openwave™ Openwave Systems Inc. RED HAT™ Red Hat, Inc. RFMD™ RF Micro Devices, Inc. SIRIUS™ of Sirius Satellite Radio Inc. SOLARIS™ of Sun Microsystems, Inc. SPANSION™ of Spansion LLC Ltd. Symbian™ of Symbian Software Limited. TAIYO YUDEN™ of Taiyo Yuden Co. TEAKLITE™ of CEVA, Inc. TEKTRONIX™ of Tektronix Inc. TOKO™ of TOKO KABUSHIKI KAISHA TA. UNIX™ of X/Open Company Limited. VERILOG™, PALLADIUM™ of Cadence Design Systems, Inc. VLYNQ™ of Texas Instruments Incorporated. VXWORKS™, WIND RIVER™ of WIND RIVER SYSTEMS, INC. ZETEX™ of Diodes Zetex Limited.

Last Trademarks Update 2010-10-26

# 1 Uni-directional Ultra-low Capacitance ESD / Transient Protection Array

## 1.1 Features

- ESD / Transient protection of high speed data lines exceeding:
  - IEC61000-4-2 (ESD):  $\pm 20$  kV (air / contact)
  - IEC61000-4-4 (EFT): 2.5 kV / 50 A (5/50 ns)
  - IEC61000-4-5 (surge): 3 A (8/20  $\mu$ s)
- Maximum working voltage:  $V_R = 5.3$  V
- Very low reverse current:  $I_R < 1$  nA typ.
- Extremely low capacitance: 0.4 pF typ. (I/O to GND)
- Four-lines protection array with pad pitch = 0.5 mm
- Flow-through design for optimal PCB layout of differential lines
- Pb-free package (RoHS compliant) and halogen free package



## 1.2 Application Examples

- Protection of high speed digital interfaces like:
- HDMI 1.3, HDMI 1.4a, MHL, DisplayPort, S-ATA, DVI, MIPI, MDDI
- USB2.0, 10/100/1000 Ethernet, FireWire

# 2 Product Description

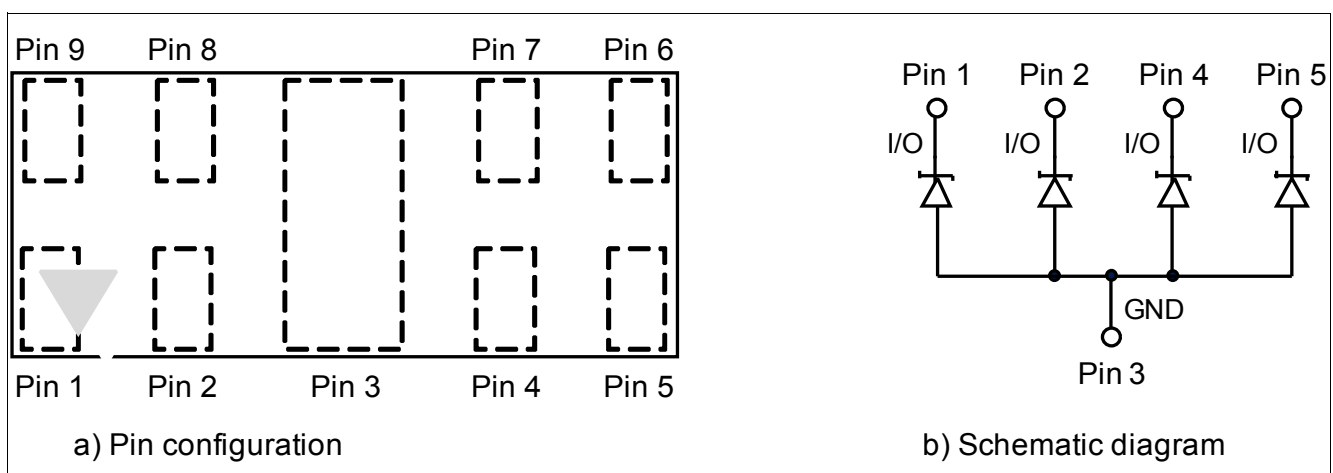

Figure 2-1 Pin Configuration and Schematic Diagram

Table 2-1 Ordering information

Type	Package	Configuration	Marking code
ESD5V3U4U-HDMI	PG-TSLP-9-1	4 lines, uni-directional	Z1

### 3 Characteristics

**Table 3-1 Maximum Rating at  $T_A = 25\text{ }^\circ\text{C}$ , unless otherwise specified**

Parameter	Symbol	Values			Unit
		Min.	Typ.	Max.	
ESD (air / contact) discharge <sup>1)</sup>	$V_{ESD}$	–	–	20	kV
Peak pulse current ( $t_p = 8/20\text{ }\mu\text{s}$ ) <sup>2)</sup>	$I_{PP}$	–	–	3	A
Operating temperature range	$T_{OP}$	-40	–	125	$^\circ\text{C}$
Storage temperature	$T_{stg}$	-65	–	150	$^\circ\text{C}$

1)  $V_{ESD}$  according to IEC61000-4-2

2)  $I_{PP}$  according to IEC61000-4-5

#### 3.1 Electrical Characteristics at $T_A = 25\text{ }^\circ\text{C}$ , unless otherwise specified

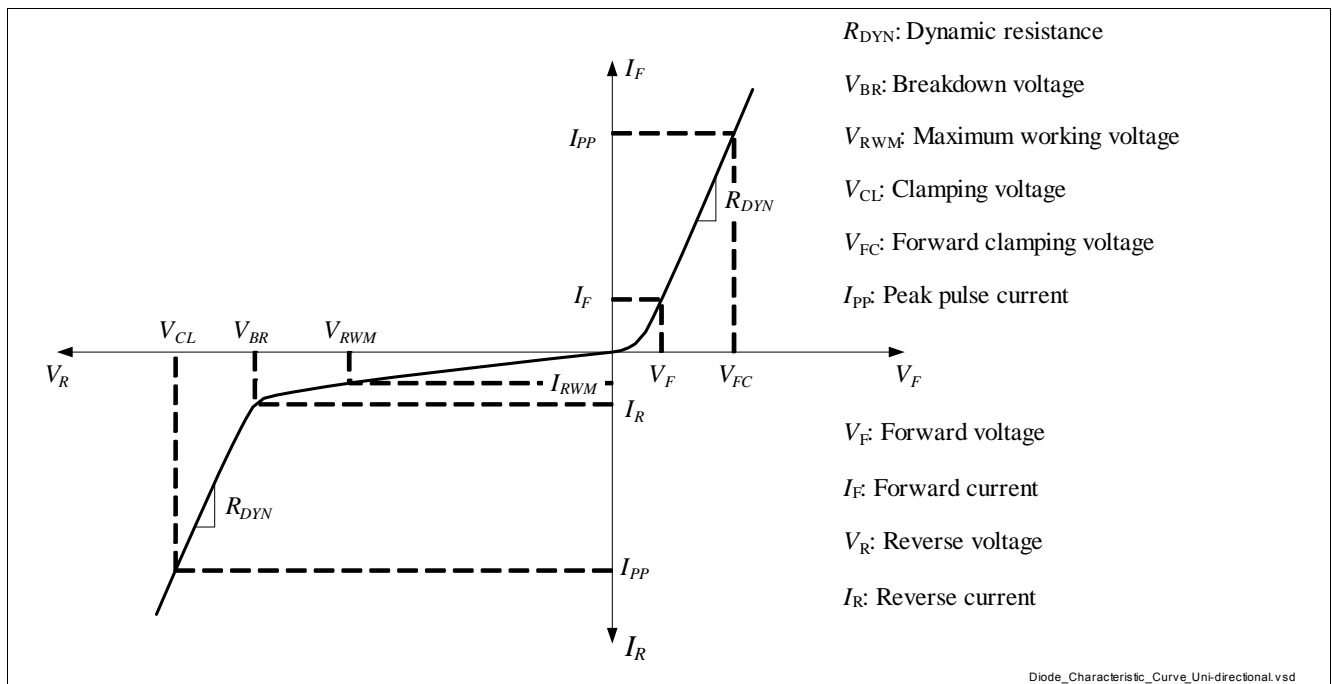

**Figure 3-1 Definitions of Electrical Characteristics**

**Table 3-2 DC Characteristics at  $T_A = 25\text{ }^\circ\text{C}$ , unless otherwise specified**

Parameter	Symbol	Values			Unit	Note / Test Condition
		Min.	Typ.	Max.		
Reverse working voltage	$V_{RWM}$	–	–	5.3	V	
Breakdown voltage	$V_{BR}$	6	–	–	V	$I_{BR} = 1\text{ mA}$ (I/O to GND)
Reverse current	$I_R$	–	<1	50	nA	$V_R = 5.3\text{ V}$ (I/O to GND)

**Table 3-3 RF Characteristics at  $T_A = 25\text{ }^\circ\text{C}$ , unless otherwise specified**

Parameter	Symbol	Values			Unit	Note / Test Condition
		Min.	Typ.	Max.		
Line capacitance <sup>1)</sup>	$C_L$	–	0.4	0.6	pF	$V_R = 0\text{ V}$ , $f = 1\text{ MHz}$ (I/O to GND)
Line capacitance <sup>1)</sup>	$C_L$	–	0.2	0.3	pF	$V_R = 0\text{ V}$ , $f = 1\text{ MHz}$ (I/O to I/O)

1) Total capacitance line to ground

**Table 3-4 ESD Characteristics at  $T_A = 25\text{ }^\circ\text{C}$ , unless otherwise specified**

Parameter	Symbol	Values			Unit	Note / Test Condition
		Min.	Typ.	Max.		
Clamping voltage <sup>1)</sup>	$V_{CL}$	–	19	–	V	$I_{PP} = 16\text{ A}$ (I/O to GND)
		–	28	–	V	$I_{PP} = 30\text{ A}$ (I/O to GND)
Forward clamping voltage <sup>1)</sup>	$V_{FC}$	–	10	–	V	$I_{PP} = 16\text{ A}$ (GND to I/O)
		–	17	–	V	$I_{PP} = 30\text{ A}$ (GND to I/O)
Dynamic resistance <sup>1)</sup>	$R_{DYN}$	–	0.6	–	$\Omega$	I/O to GND
		–	0.5	–		GND to I/O

1) Please refer to Application Note AN210 [1]. TLP parameter:  $Z_0 = 50\ \Omega$ ,  $t_p = 100\text{ ns}$ ,  $t_r = 300\text{ ps}$ , averaging window:  $t_1 = 30\text{ ns}$  to  $t_2 = 60\text{ ns}$ , extraction of dynamic resistance using least squares fit of TLP characteristic between  $I_{PP1} = 10\text{ A}$  and  $I_{PP2} = 40\text{ A}$ .

3.2 Typical Characteristics at  $T_A = 25^\circ\text{C}$ , unless otherwise specified

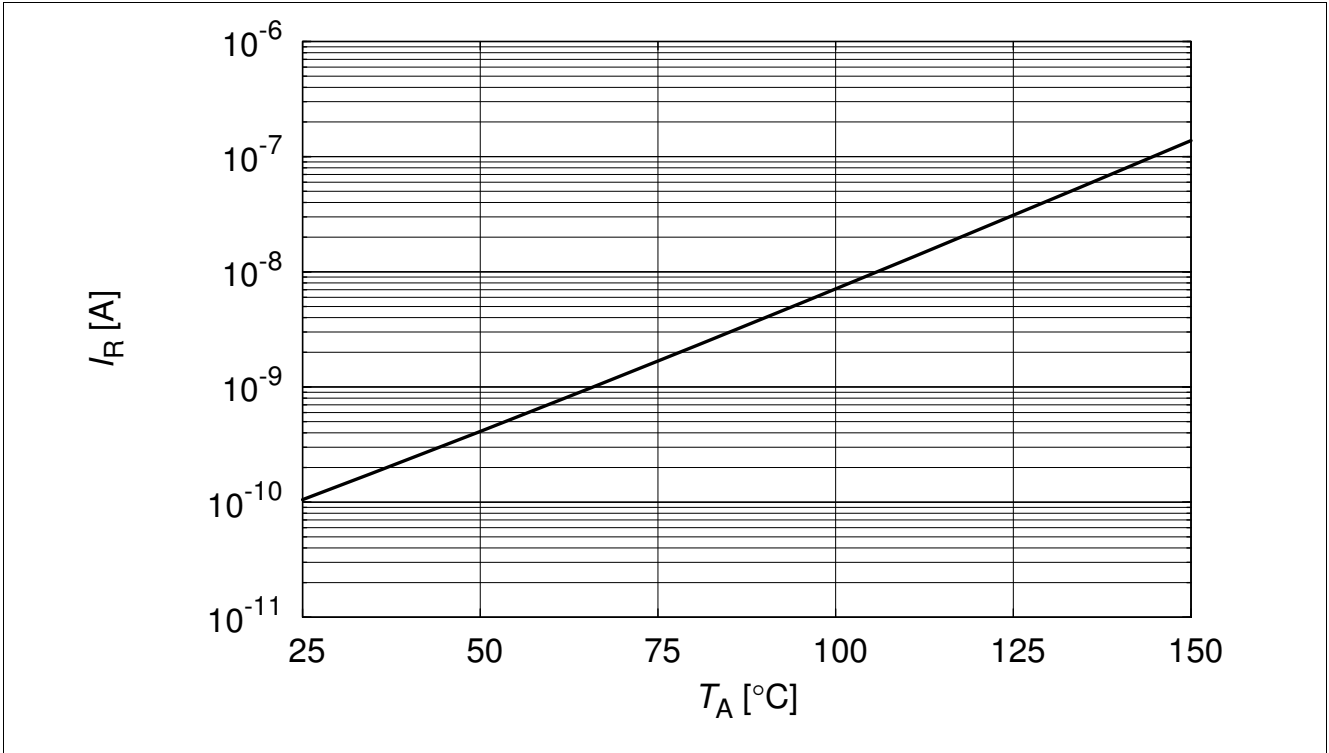

Figure 3-2 Reverse current:  $I_R = f(T_A)$ ,  $V_R = 5.3 \text{ V}$ , (I/O to GND)

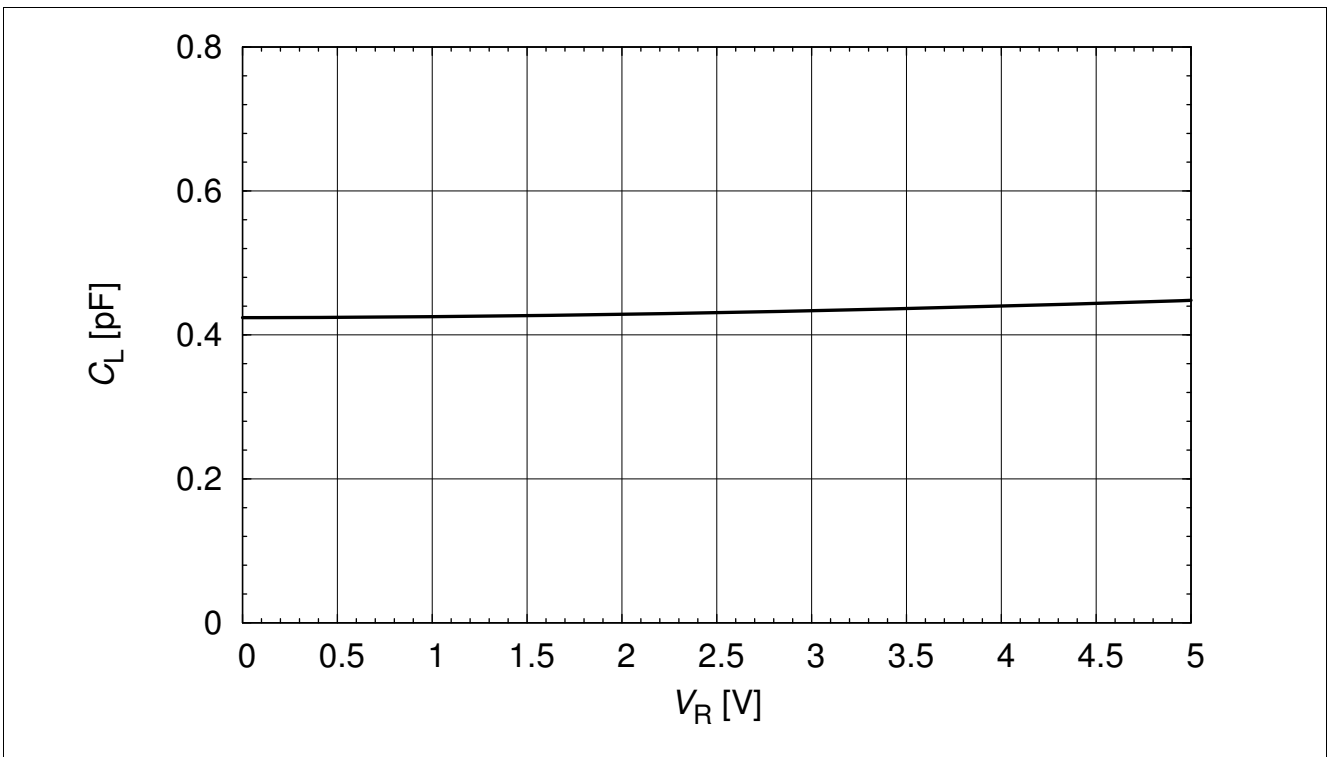

Figure 3-3 Diode capacitance:  $C_L = f(V_R)$ , (I/O to GND)

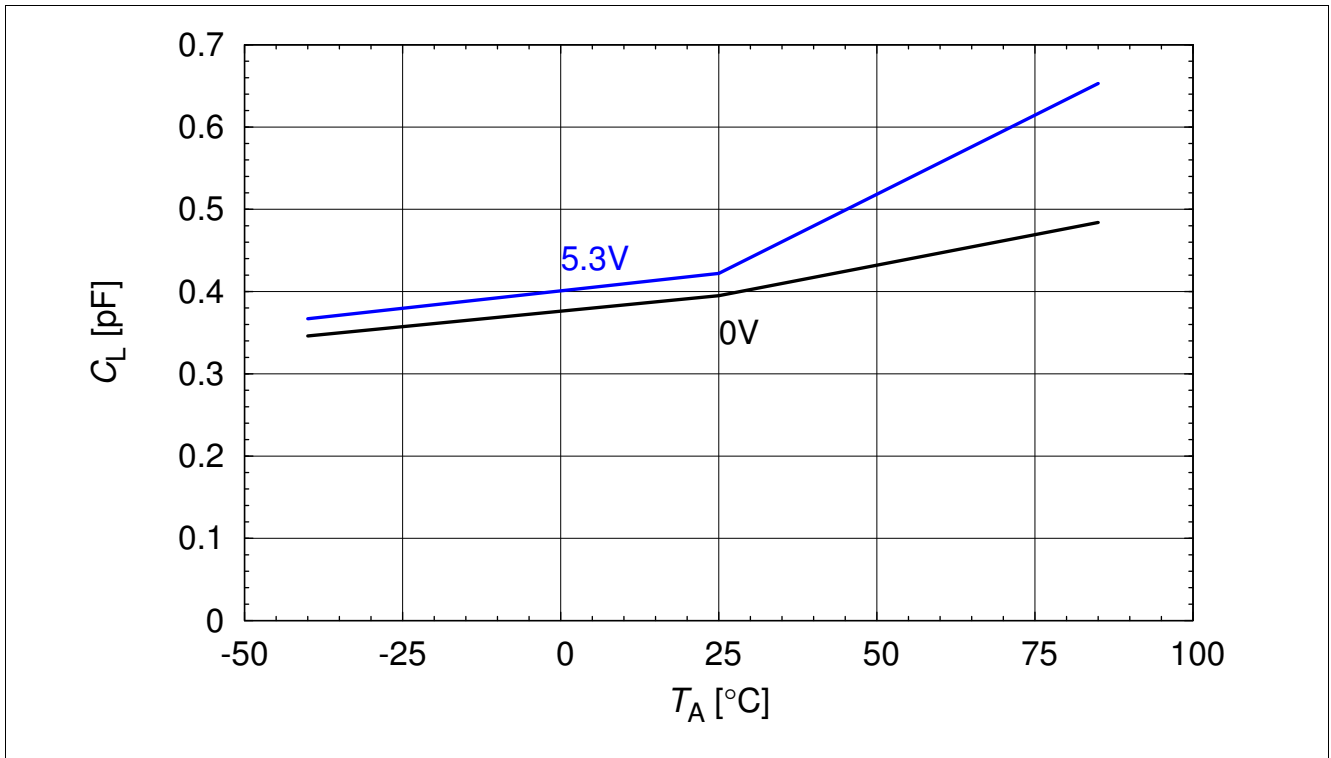

Figure 3-4 Line capacitance:  $C_L = f(T_A)$

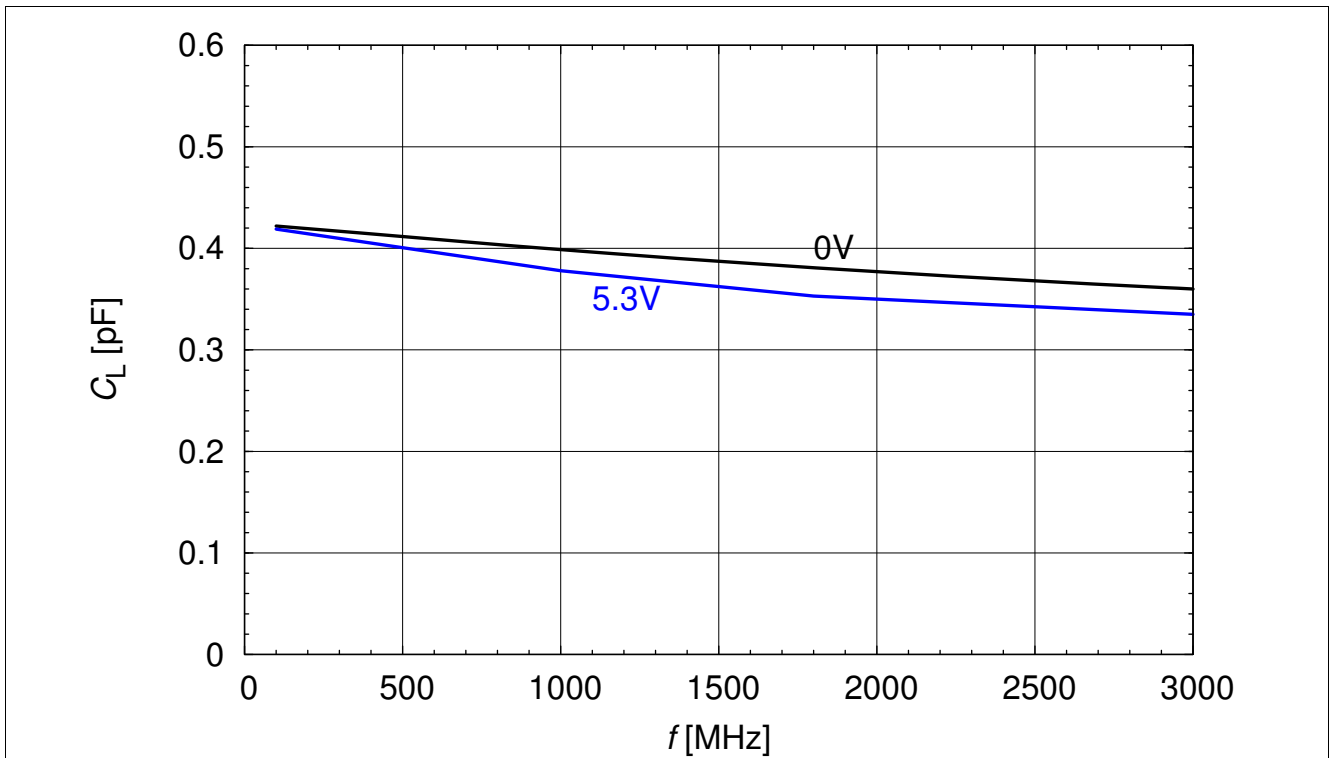

Figure 3-5 Line capacitance:  $C_L = f(f)$ , (I/O to GND)

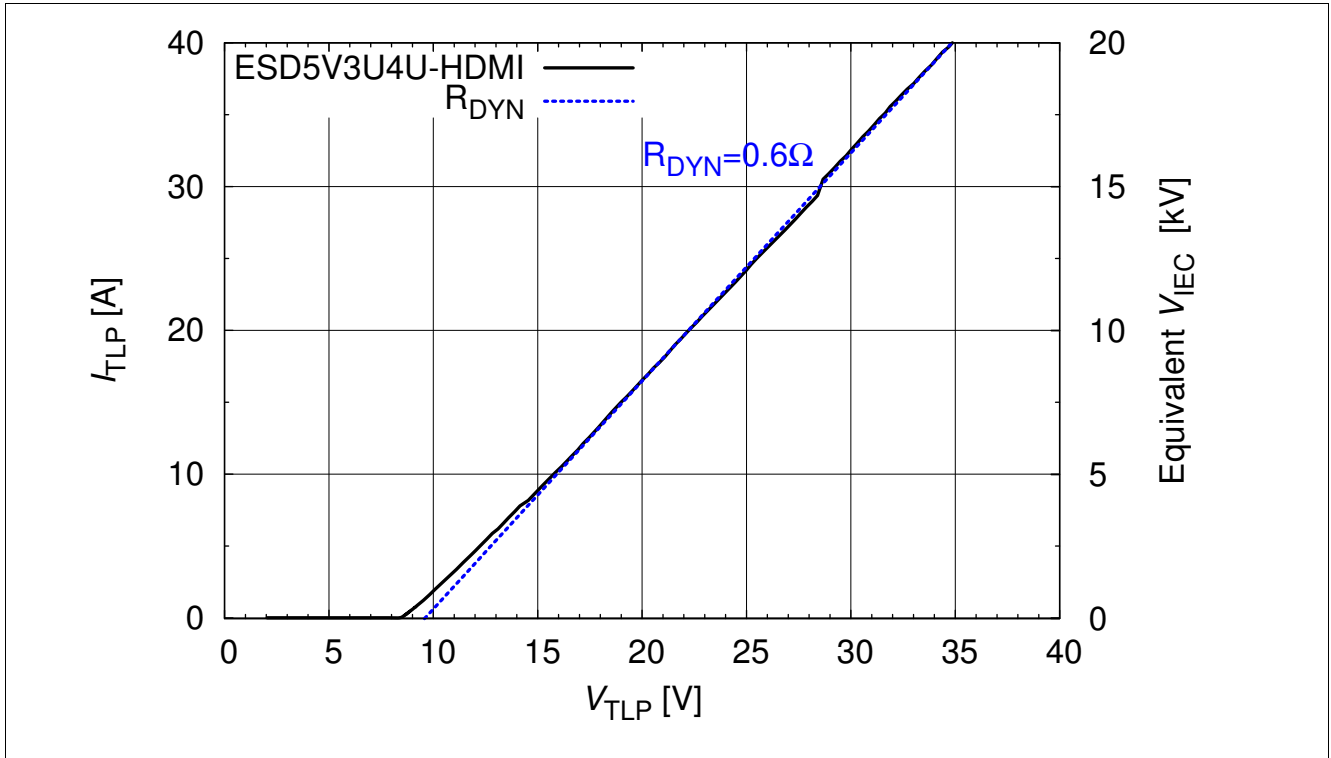

Figure 3-6 Forward clamping voltage:  $I_{TLP} = f(V_{TLP})$ , (GND to I/O) [1]

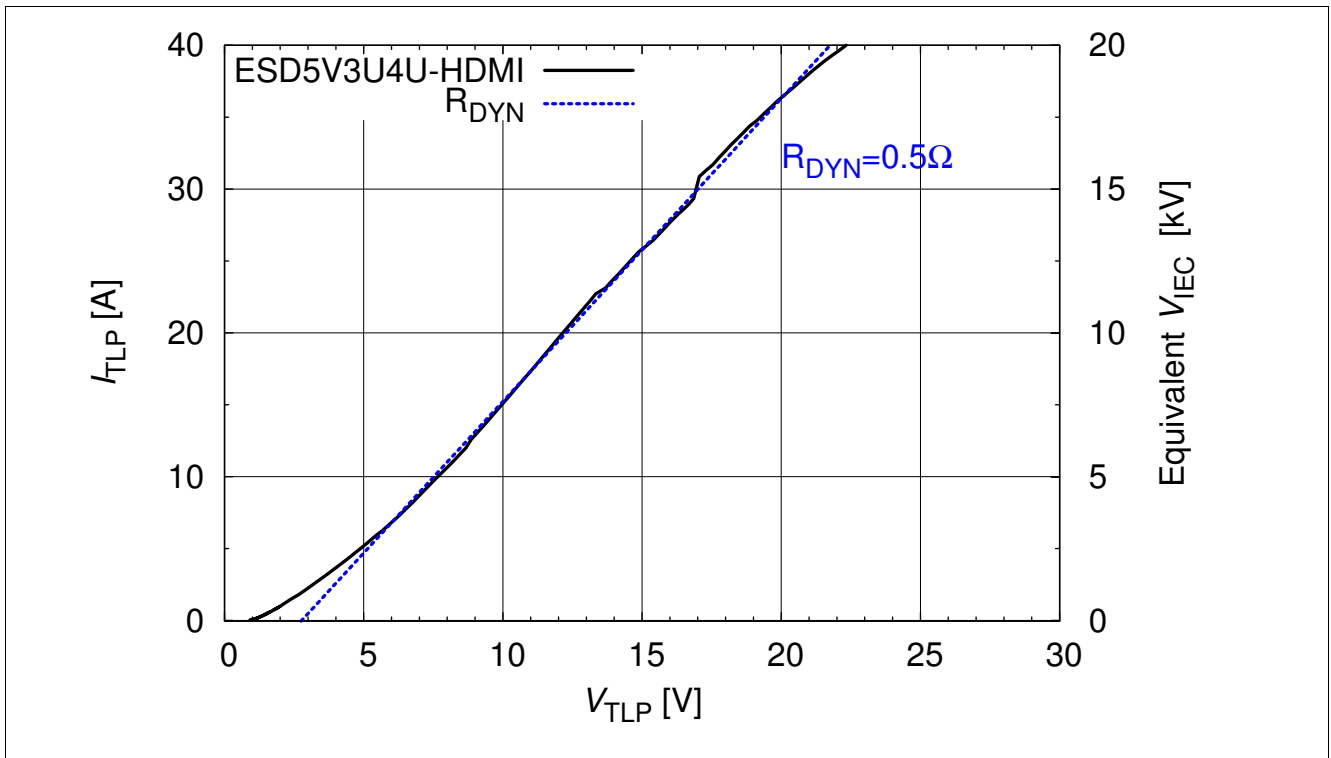

Figure 3-7 Reverse clamping voltage:  $I_{TLP} = f(V_{TLP})$ , (I/O to GND) [1]

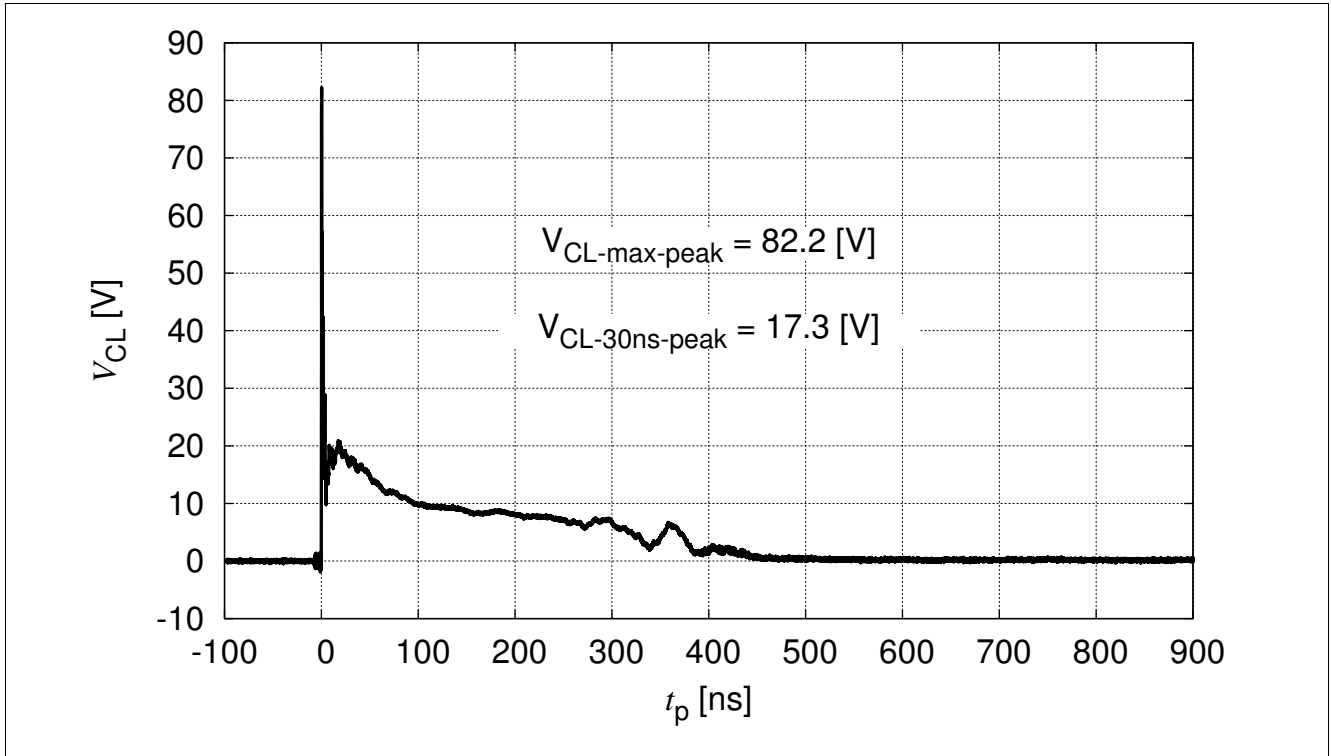

Figure 3-8 IEC61000-4-2  $V_{CL} = f(t)$ , 8 kV positive pulse, (I/O to GND)

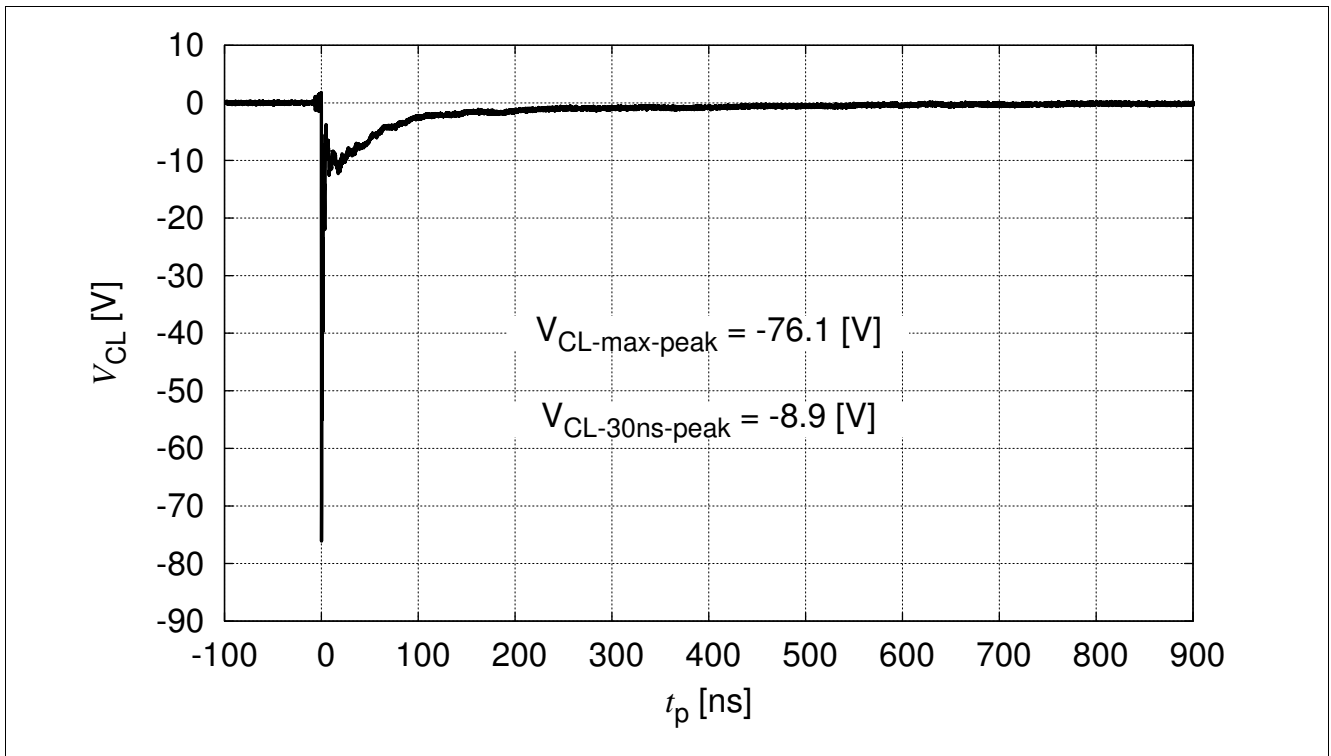

Figure 3-9 IEC61000-4-2  $V_{CL} = f(t)$ , 8 kV negative pulse, (I/O to GND)

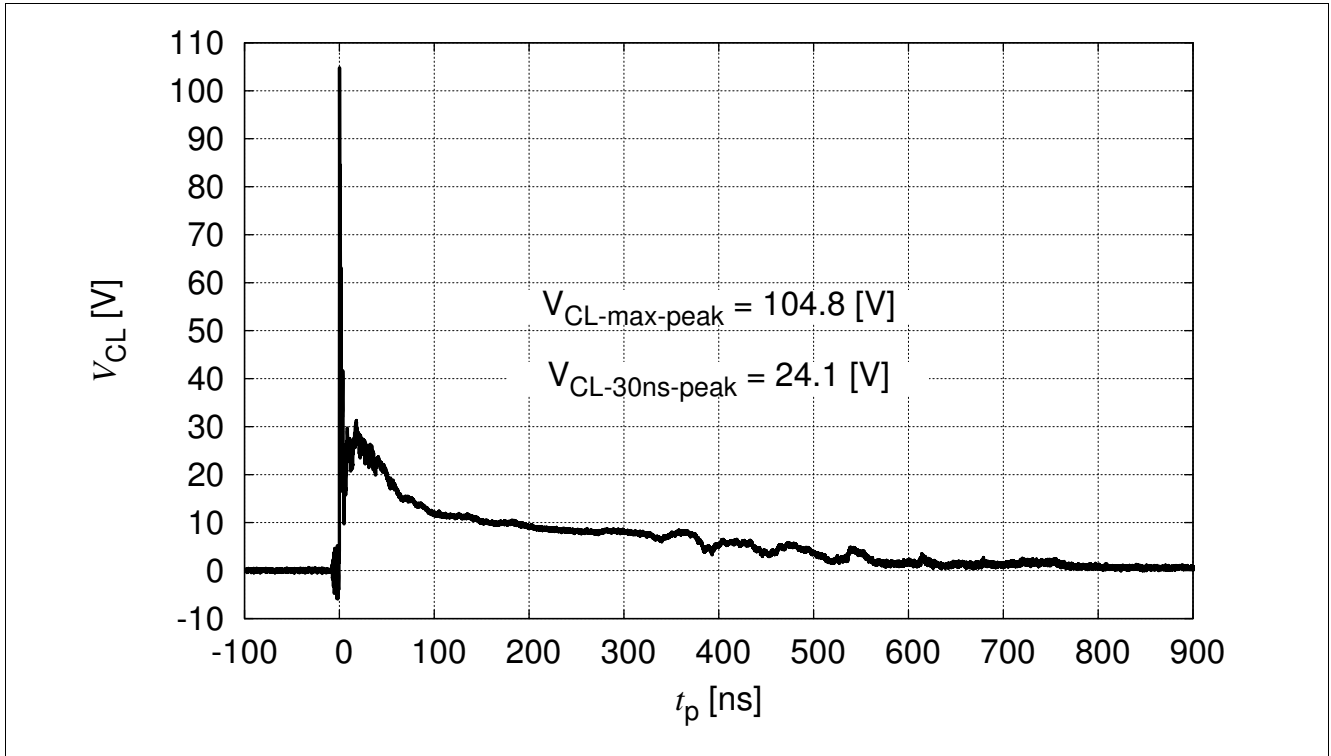

Figure 3-10 IEC61000-4-2  $V_{CL} = f(t)$ , 15 kV positive pulse, (I/O to GND)

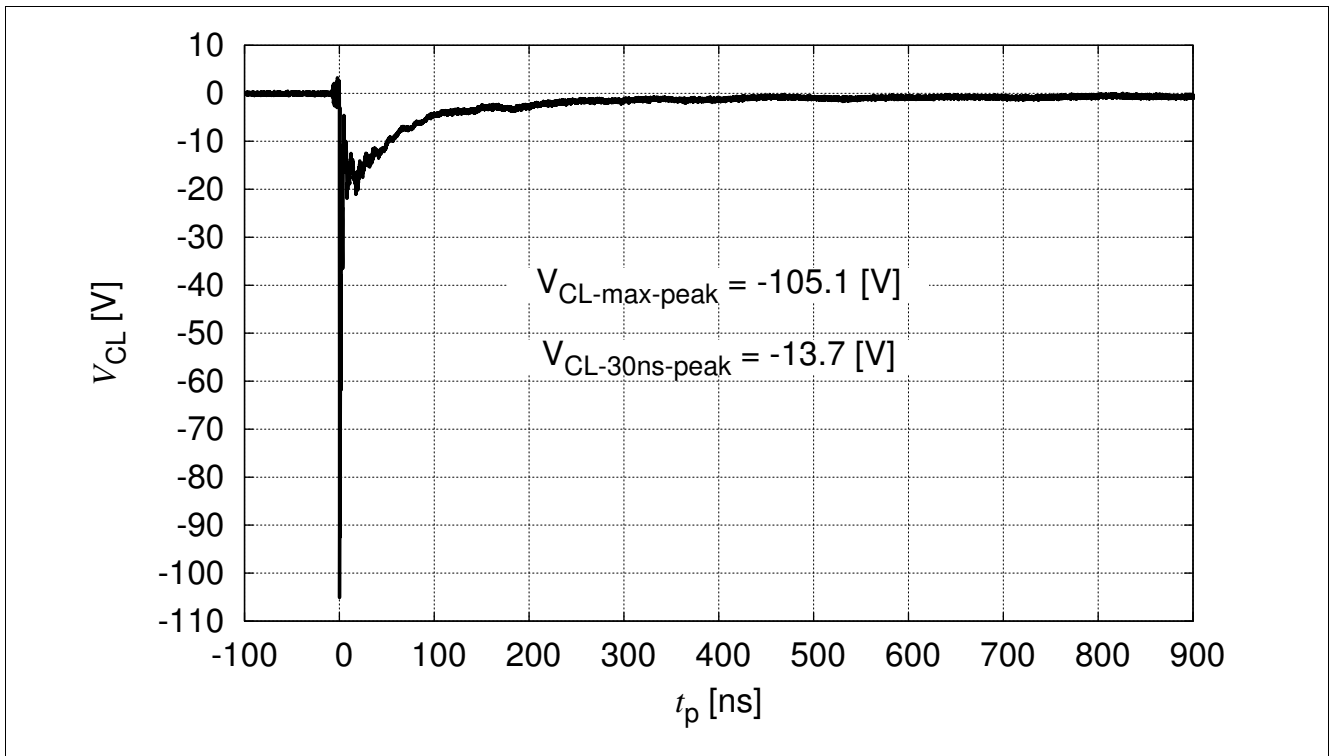
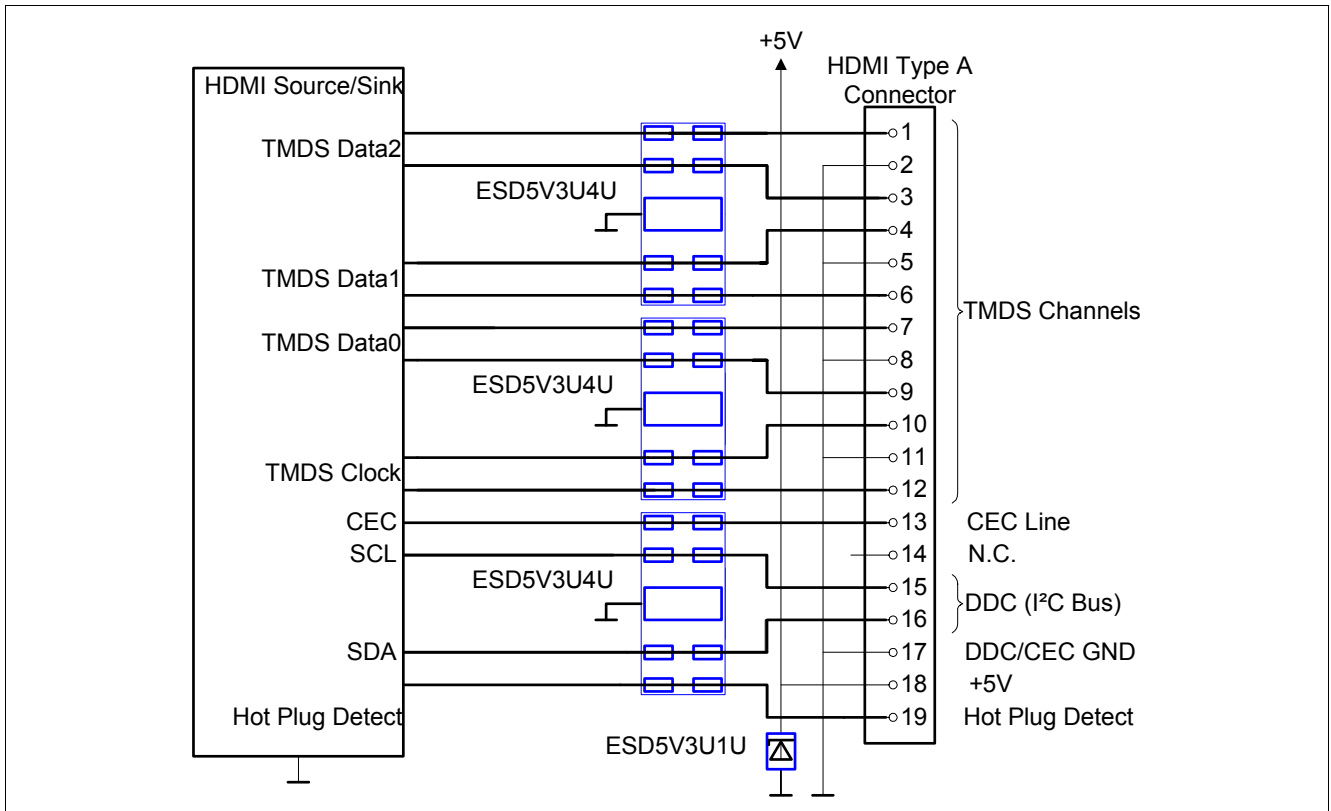

Figure 3-11 IEC61000-4-2  $V_{CL} = f(t)$ , 15 kV negative pulse, (I/O to GND)

## 4 Application Information



**Figure 4-1 4 lines, uni-directional ESD5V3U4U-HDMI**

For protection on the 5 V supply rail please refer to ESD5V3U1U- TVS diode data sheet.

## 5 Ordering Information Scheme (Examples)

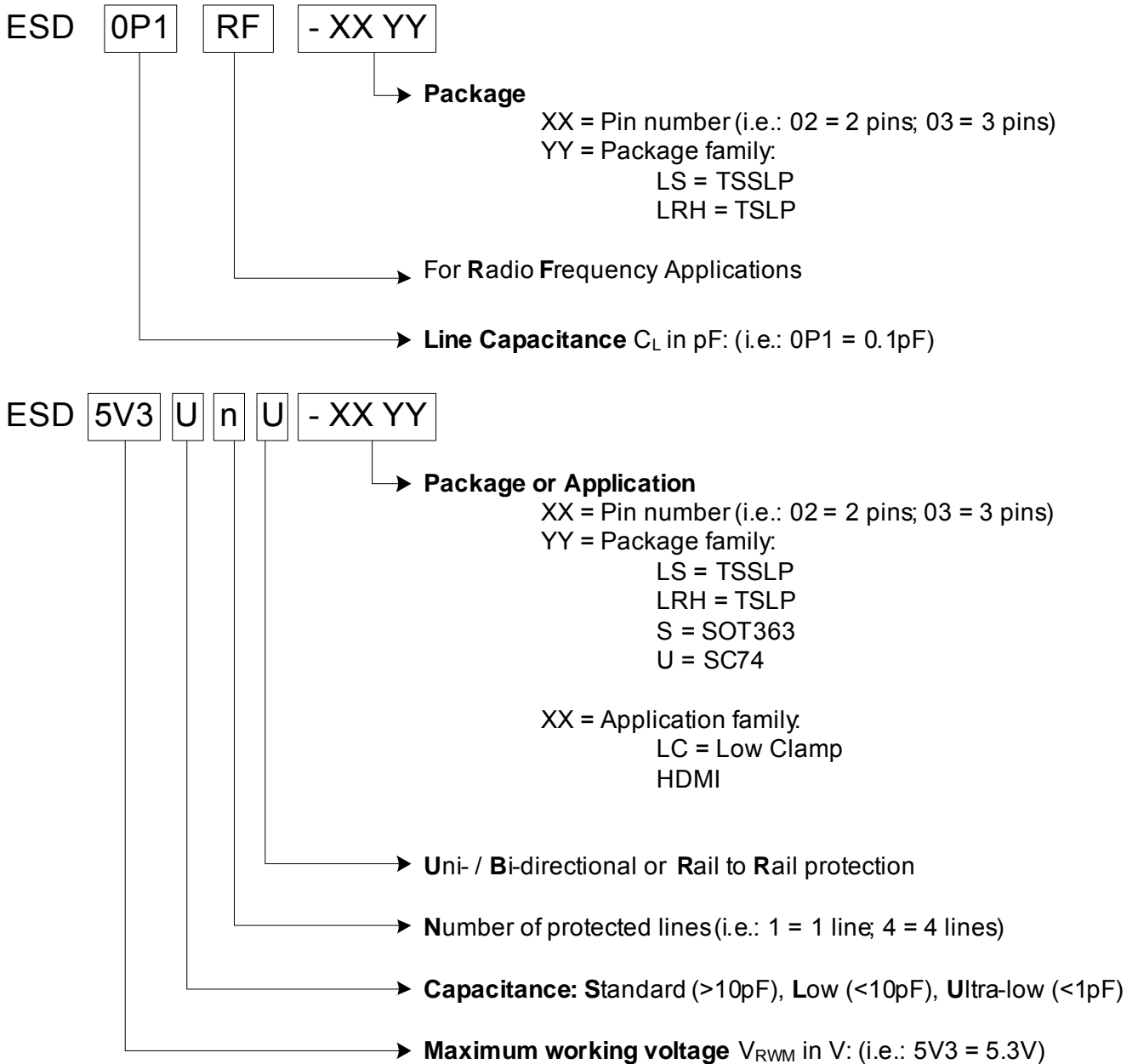

Figure 5-1 Ordering information scheme



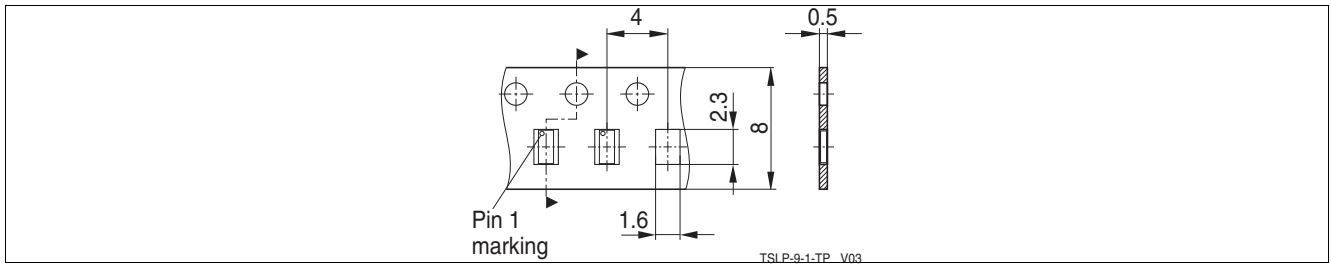

Figure 6-3 PG-TSLP-9-1: Packing

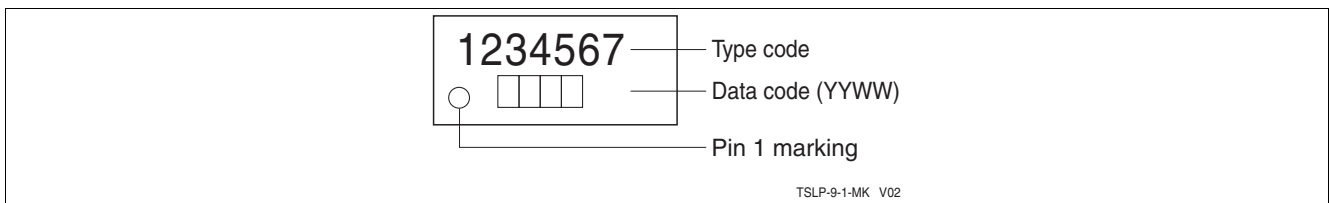

Figure 6-4 PG-TSLP-9-1: Marking (example)

**References**

- [1] Infineon AG - **Application Note AN210**: Effective ESD Protection Design at System Level Using VF-TLP Characterization Methodology

[www.infineon.com](http://www.infineon.com)

Published by Infineon Technologies AG

## Looking for pricing, stock, or lifecycle information?

Click below to explore more details on WIN SOURCE:

- ⊖ [View ESD5V3U4U-HDMI E6327 on WIN SOURCE](#)
- ⊖ [Infineon Technologies Information](#)

## Optimize Your Supply Chain with WIN SOURCE Solutions

- ✓ Global Sourcing Solution
- ✓ Obsolete Management
- ✓ Cost Control Management
- ✓ Shortage Management
- ✓ Alternative Solution
- ✓ Excess Inventory Management