



THE DATASHEET OF ERZ-SF2MK820



“ZNR” Transient/Surge Absorbers, SMD MoLd

Type: **VF**
 Type: **CF**
 Type: **SF**



Features

- Large withstanding surge current capability in compact size
- Designed for flow/reflow solderings
- Excellent response against high steep surge voltage
- Low clamping voltage for better surge protection

Recommended Applications

- Protection of communication module (Modem, xDSL, Terminal Adopter)
- Protection of consumer equipment
- Protection of industrial equipment
- Protection of automobile equipment
- Absorption of switching surge from relays

Precautions for Handling

See Page 134 to 136

Explanation of Part Numbers



Construction

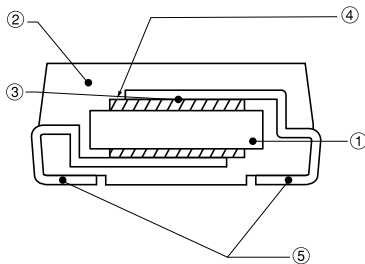

① ZNR element	ZnO etc.
② Resin mold	Epoxy Resin(UL94V-0 approved)
③ Conductive adhesive	Silver
④ Electrode	Silver
⑤ Lead terminals	Soldered Ni-Fe Alloy

Dimensions in mm (not to scale)

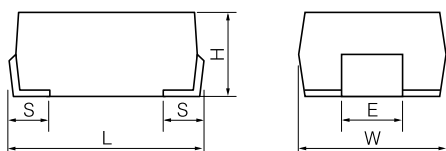

Type	W	L	H	S	E
VF□M	6.0±0.4	8.0±0.5	3.2±0.3	1.3±0.3	2.5±0.2
VF□T	6.0±0.4	8.0±0.5	2.3±0.1	1.3±0.3	2.5±0.2
CF	6.0±0.4	8.0±0.5	3.2±0.3	1.3±0.3	2.5±0.2
SF	6.2±0.4	8.0±0.5	3.2±0.3	1.3±0.3	2.5±0.2

■ Ratings and Characteristics

- Operating Temperature Range: -40 to 85 °C
- Storage Temperature Range: -40 to 125 °C
- Temperature Coefficient of Varistor Voltage: 0 to -0.05 %/°C

Part No.	Varistor Voltage	Maximum Allowable Voltage		Clamping Voltage at I _p (max.)		Rated Power (W)	Maximum Energy (2 ms) (W)	Maximum Peak Current (8/20 μs, 2 times) (A)	
	V _{1mA} (V)	ACrms (V)	DC (V)	V _{xA} (V)	I _p (A)				
Type VF□M	*ERZVF□M220	22(20~ 24)	14	18	43	2.5	0.01	0.5	125
	*ERZVF□M270	27(24~ 30)	17	22	53	2.5	0.01	0.7	125
	*ERZVF□M330	33(30~ 36)	20	26	65	2.5	0.01	0.8	125
	*ERZVF□M390	39(35~ 43)	25	31	77	2.5	0.01	0.9	125
	*ERZVF□M470	47(42~ 52)	30	38	93	2.5	0.01	1.1	125
	*ERZVF□M560	56(50~ 62)	35	45	110	2.5	0.01	1.3	125
	*ERZVF□M680	68(61~ 75)	40	56	135	2.5	0.01	1.6	125
	ERZVF□M820	82(74~ 90)	50	65	135	10	0.1	2.5	600
	ERZVF□M101	100(90~110)	60	85	165	10	0.1	3.0	600
	ERZVF□M121	120(108~132)	75	100	200	10	0.1	3.5	600
	ERZVF□M151	150(135~165)	95	125	250	10	0.1	4.5	600
	ERZVF□M201	200(185~225)	130	170	340	10	0.1	6.0	600
	ERZVF□M221	220(198~242)	140	180	360	10	0.1	6.5	600
	ERZVF□M241	240(216~264)	150	200	395	10	0.1	7.5	600
	ERZVF□M271	270(247~303)	175	225	455	10	0.1	8.0	600
	*ERZVF□M331	330(297~363)	210	270	545	10	0.1	8.0	300
	*ERZVF□M361	360(324~396)	230	300	595	10	0.1	9.0	300
	*ERZVF□M391	390(351~429)	250	320	650	10	0.1	9.0	300
	*ERZVF□M431	430(387~473)	275	350	710	10	0.1	10.0	300
	*ERZVF□M471	470(423~517)	300	385	775	10	0.1	10.0	300

└ Packaging Style Code: "1" for bulk, "2" for embossed taping

Part No.	Varistor Voltage	Maximum Allowable Voltage		Clamping Voltage at I _p (max.)		Rated Power (W)	Maximum Energy (2 ms) (W)	Maximum Peak Current (8/20 μs, 2 times) (A)	
	V _{1mA} (V)	ACrms (V)	DC (V)	V _{xA} (V)	I _p (A)				
Type VF□T	ERZVF□T820	82(74~ 90)	50	65	145	5	0.1	1.7	400
	ERZVF□T101	100(90~110)	60	85	175	5	0.1	2.0	400
	ERZVF□T151	150(135~165)	95	125	260	5	0.1	3.0	400
	ERZVF□T241	240(216~264)	150	200	415	5	0.1	5.0	400
	ERZVF□T271	270(247~303)	175	225	475	5	0.1	6.0	400

└ Packaging Style Code: "1" for bulk, "2" for embossed taping

■ Ratings and Characteristics

- Operating Temperature Range: -40 to 85 °C
- Storage Temperature Range: -40 to 125 °C
- Temperature Coefficient of Varistor Voltage: 0 to -0.05 %/°C

Part No.	Varistor Voltage	Maximum Allowable Voltage		Clamping Voltage at I _p (max.)		Rated Power (W)	Maximum Energy (2 ms) (J)	Maximum Peak Current (8/20 μs, 2 times) (A)	
	V _{0.1mA} (V)	ACrms (V)	DC (V)	V _{xA} (V)	I _p (A)				
Type CF	ERZCF□MK220	22 (20– 24)	14	18	48	1	0.01	0.4	50
	ERZCF□MK270	27 (24– 30)	17	22	60	1	0.01	0.5	50
	ERZCF□MK330	33 (30– 36)	20	26	73	1	0.01	0.6	50
	ERZCF□MK390	39 (35– 43)	25	31	86	1	0.01	0.8	50
	ERZCF□MK470	47 (42– 52)	30	38	104	1	0.01	1.0	50
	ERZCF□MK560	56 (50– 62)	35	45	123	1	0.01	1.0	50
	ERZCF□MK680	68 (61– 75)	40	56	150	1	0.01	1.2	50
	ERZCF□MK820	82 (74– 90)	50	65	145	5	0.1	1.7	200
	ERZCF□MK101	100 (90–110)	60	85	175	5	0.1	2.0	200
	ERZCF□MK121	120 (108–132)	75	100	210	5	0.1	2.5	200
	ERZCF□MK151	150 (135–165)	95	125	260	5	0.1	3.0	200
	ERZCF□MK201	200 (185–225)	130	170	355	5	0.1	4.0	200
	ERZCF□MK221	220 (198–242)	140	180	380	5	0.1	4.5	200
	ERZCF□MK241	240 (216–264)	150	200	415	5	0.1	5.0	200
	ERZCF□MK271	270 (247–303)	175	225	475	5	0.1	6.0	200
	ERZCF□MK361	360 (324–396)	230	300	620	5	0.1	6.0	200
	ERZCF□MK391	390 (351–429)	250	320	675	5	0.1	6.0	200
	ERZCF□MK431	430 (387–473)	275	350	745	5	0.1	6.3	200
ERZCF□MK471	470 (423–517)	300	385	810	5	0.1	7.0	200	

↑ Packaging Style Code: “1” for bulk, “2” for embossed taping

Part No.	Varistor Voltage	Maximum Allowable Voltage		Clamping Voltage at I _p (max.)		Rated Power (W)	Maximum Energy (2 ms) (J)	Maximum Peak Current (8/20 μs, 2 times) (A)	
	V _{1mA} (V)	ACrms (V)	DC (V)	V _{xA} (V)	I _p (A)				
Type SF	ERZSF□MK220	22 (20– 25)	14	18	43	2.5	0.02	0.9	125
	ERZSF□MK270	27 (24– 30)	17	22	53	2.5	0.02	1.0	125
	ERZSF□MK330	33 (30– 36)	20	26	65	2.5	0.02	1.2	125
	ERZSF□MK390	39 (35– 43)	25	31	77	2.5	0.02	1.5	125
	ERZSF□MK470	47 (42– 52)	30	38	93	2.5	0.02	1.8	125
	ERZSF□MK560	56 (50– 62)	35	45	110	2.5	0.02	2.2	125
	ERZSF□MK680	68 (61– 75)	40	56	135	2.5	0.02	2.5	125
	ERZSF□MK820	82 (74– 90)	50	65	135	10	0.25	3.5	600
	ERZSF□MK101	100 (90–110)	60	85	165	10	0.25	4.0	600
	ERZSF□MK121	120 (108–132)	75	100	200	10	0.25	5.0	600
	ERZSF□MK151	150 (135–165)	95	125	250	10	0.25	6.0	600
	ERZSF□MK201	200 (185–225)	130	170	340	10	0.25	8.0	600
	ERZSF□MK221	220 (198–242)	140	180	360	10	0.25	9.0	600
	ERZSF□MK241	240 (216–264)	150	200	395	10	0.25	10.0	600
	ERZSF□MK271	270 (247–303)	175	225	455	10	0.25	12.0	600
	ERZSF□MK361	360 (324–396)	230	300	595	10	0.20	12.0	400
	ERZSF□MK391	390 (351–429)	250	320	650	10	0.20	12.0	400
	ERZSF□MK431	430 (387–473)	275	350	710	10	0.20	14.0	400
ERZSF□MK471	470 (423–517)	300	385	775	10	0.20	14.0	400	

↑ Packaging Style Code: “1” for bulk, “2” for embossed taping

■ Typical Characteristics

■ Voltage vs. Current

■ ERZVF1(2)M220 to ERZVF1(2)M680

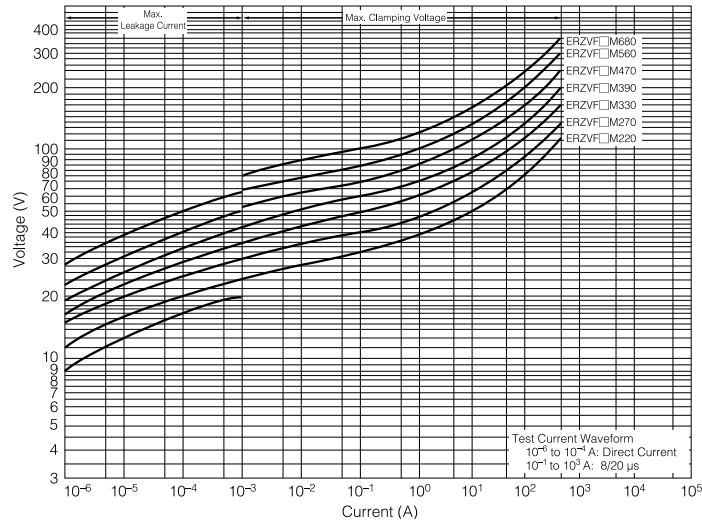

■ Impulse



■ ERZVF1(2)M820 to ERZVF1(2)M471

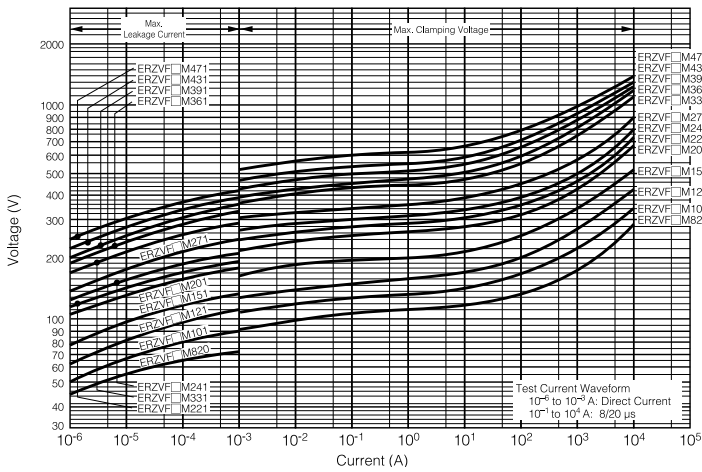

ERZVF1(2)M820 to ERZVF1(2)M271

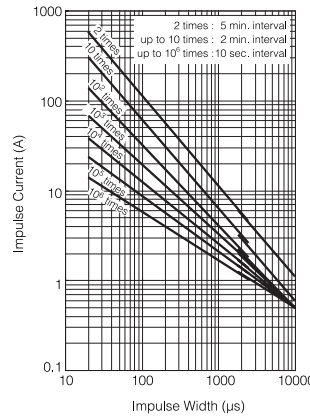

ERZVF1(2)M331 to ERZVF1(2)M471

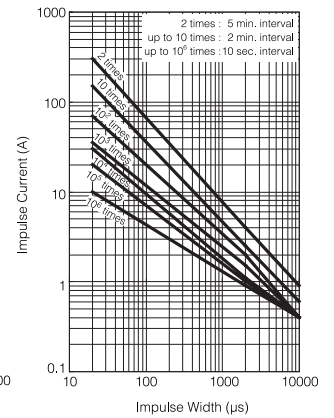

■ ERZVF1(2)T820 to ERZVF1(2)T271

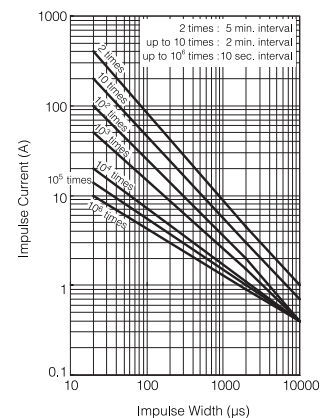
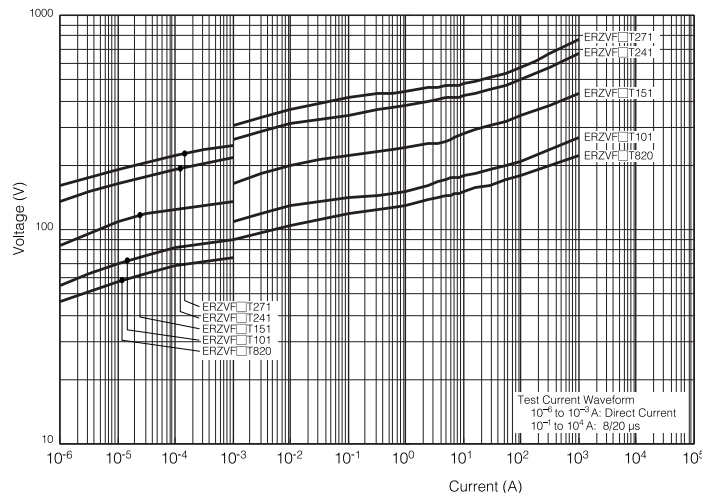

■ Typical Characteristics

■ Voltage vs. Current

■ ERZCF1 (2) MK220 to ERZCF1 (2) MK680



■ Impulse



■ ERZCF1 (2) MK820 to ERZCF1 (2) MK471

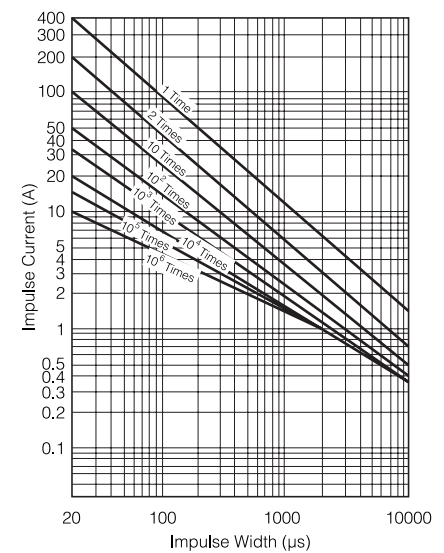

■ Typical Characteristics

■ Voltage vs. Current

■ ERZSF1 (2) MK220 to ERZSF1 (2) MK680



■ Impulse

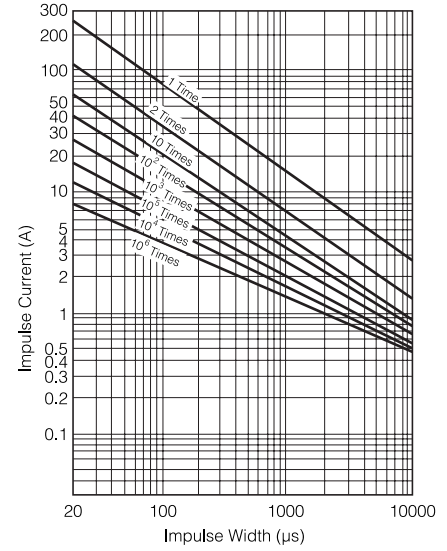

■ ERZSF1 (2) MK820 to ERZSF1 (2) MK471

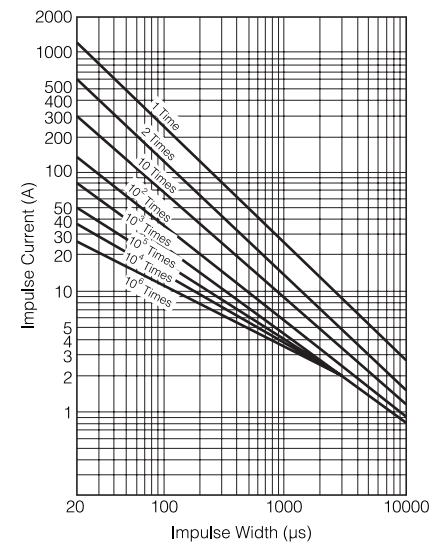

■ Marking Contents



① Trade Mark	Trade Mark
② Product Name	ZNR
③ Type	VF□M Type:VFM, VF□T Type:VFT CF Type:FK, SF Type:SF
④ Abbreviation of Part No.	The first two digits are significant figures and the third one denotes the number of zeros following.
⑤ Date Code	Left(Year): 2002:B, 2003:C, 2004:D, 2005:E, 2006:F Right(Month): Jan. to Sep.:1 to 9, Oct.:0, Nov.:N, Dec.:D

■ Packaging Specifications

● Packing Quantity

Size Code	Style	Embossed taping	Bulk
“VF□M”, “VF□T”, “CF”, “SF”		2000 pcs./reel	200 pcs./bag

● Reel

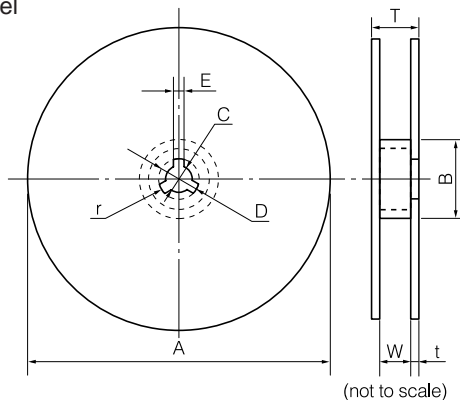

Dimensions (mm)	A	B	C	D	E
	382 max.	50 min.	13.0±0.5	21.0±0.8	2.0±0.5
Dimensions (mm)	W	T	t	r	
	16.4 ^{+2.0} ₀	22.4 max.	2.5±0.5	1.0	

● Embossed Taping

(W=16 mm)

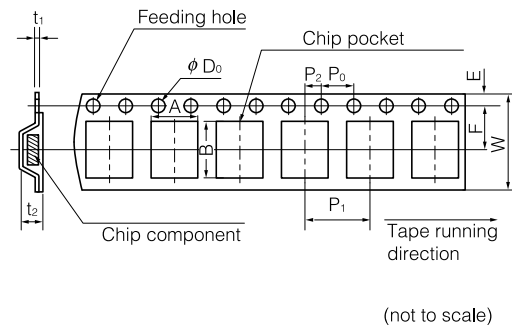



Dimensions (mm)	A	B	W	F	E	P ₁
	6.8±0.2	11.9 max.	16.0±0.3	7.5±0.1	1.75±0.10	8.0±0.1
Dimensions (mm)	P ₂	P ₀	φD ₀	t ₁	t ₂	
	2.0±0.1	4.0±0.1	1.5 ^{+0.1} ₀	0.6 max.	6.5 max.	

■ Performance Characteristics

Characteristics	Test Methods	Specifications																																				
Standard Test Condition	Electrical measurements (initial/after tests) shall be conducted at temperature of 5 to 35 °C, relative humidity of maximum 85 %	—																																				
Varistor Voltage	The voltage between two terminals with the specified measuring current C_{mA} DC applied is called V_c or V_{CmA} . The measurement shall be made as fast as possible to avoid heat affection.	To meet the specified value.																																				
Maximum Allowable Voltage	The recommended maximum sinusoidal wave voltage (rms) or the maximum DC voltage that can be applied continuously.																																					
Clamping Voltage	The maximum voltage between two terminals with the specified impulse current (8/20 μ s).																																					
Rated Power	The maximum power that can be applied within the specified ambient temperature.																																					
Maximum Energy	Maximum energy at less than ± 10 % of varistor voltage change when the standard impulse (2 ms) is applied one time.																																					
Maximum Peak Current	Maximum current at less than ± 10 % of varistor voltage change when impulse current (8/20 μ s) is applied two times continuously with the interval of 5 minutes.																																					
Temperature Coefficient of Varistor Voltage	$\frac{V_{CmA} \text{ at } 85\text{ }^\circ\text{C} - V_{CmA} \text{ at } 25\text{ }^\circ\text{C}}{V_{CmA} \text{ at } 25\text{ }^\circ\text{C}} \times \frac{1}{60} \times 100(\%/^\circ\text{C})$	0 to -0.05 %/ $^\circ\text{C}$																																				
Impulse Life (I)	<p>The change of V_c shall be measured after the specified impulse is applied 10000 times continuously with the interval of 10 seconds at room temperature.</p> <table border="1"> <thead> <tr> <th>Type</th> <th>Part Number</th> <th>Waveform</th> <th>Current</th> </tr> </thead> <tbody> <tr> <td rowspan="3">VF□M</td> <td>ERZVF□M220 to ERZVF□M680</td> <td>8/20 μs</td> <td>8 A</td> </tr> <tr> <td>ERZVF□M820 to ERZVF□M271</td> <td>8/20 μs</td> <td>40 A</td> </tr> <tr> <td>ERZVF□M331 to ERZVF□M471</td> <td>8/20 μs</td> <td>30 A</td> </tr> <tr> <td rowspan="2">VF□T</td> <td>ERZVF□T820 to ERZVF□T271</td> <td>8/20 μs</td> <td>20 A</td> </tr> <tr> <td rowspan="2">CF</td> <td>ERZCF□MK220 to ERZCF□MK680</td> <td>2 ms</td> <td>0.5 A</td> </tr> <tr> <td></td> <td>ERZCF□MK820 to ERZCF□MK471</td> <td>8/20 μs</td> <td>20 A</td> </tr> <tr> <td rowspan="3">SF</td> <td>ERZSF□MK220 to ERZSF□MK680</td> <td>8/20 μs</td> <td>18 A</td> </tr> <tr> <td>ERZSF□MK820 to ERZSF□MK271</td> <td>8/20 μs</td> <td>50 A</td> </tr> <tr> <td>ERZSF□MK331 to ERZSF□MK471</td> <td>8/20 μs</td> <td>40 A</td> </tr> </tbody> </table>	Type	Part Number	Waveform	Current	VF□M	ERZVF□M220 to ERZVF□M680	8/20 μ s	8 A	ERZVF□M820 to ERZVF□M271	8/20 μ s	40 A	ERZVF□M331 to ERZVF□M471	8/20 μ s	30 A	VF□T	ERZVF□T820 to ERZVF□T271	8/20 μ s	20 A	CF	ERZCF□MK220 to ERZCF□MK680	2 ms	0.5 A		ERZCF□MK820 to ERZCF□MK471	8/20 μ s	20 A	SF	ERZSF□MK220 to ERZSF□MK680	8/20 μ s	18 A	ERZSF□MK820 to ERZSF□MK271	8/20 μ s	50 A	ERZSF□MK331 to ERZSF□MK471	8/20 μ s	40 A	$\Delta V_{CmA}/V_{CmA} \leq \pm 10$ %
Type	Part Number	Waveform	Current																																			
VF□M	ERZVF□M220 to ERZVF□M680	8/20 μ s	8 A																																			
	ERZVF□M820 to ERZVF□M271	8/20 μ s	40 A																																			
	ERZVF□M331 to ERZVF□M471	8/20 μ s	30 A																																			
VF□T	ERZVF□T820 to ERZVF□T271	8/20 μ s	20 A																																			
	CF	ERZCF□MK220 to ERZCF□MK680	2 ms	0.5 A																																		
		ERZCF□MK820 to ERZCF□MK471	8/20 μ s	20 A																																		
SF	ERZSF□MK220 to ERZSF□MK680	8/20 μ s	18 A																																			
	ERZSF□MK820 to ERZSF□MK271	8/20 μ s	50 A																																			
	ERZSF□MK331 to ERZSF□MK471	8/20 μ s	40 A																																			
Impulse Life (II)	<p>The change of V_c shall be measured after the specified impulse is applied 100000 times continuously with the interval of 10 seconds at room temperature.</p> <table border="1"> <thead> <tr> <th>Type</th> <th>Part Number</th> <th>Waveform</th> <th>Current</th> </tr> </thead> <tbody> <tr> <td rowspan="3">VF□M</td> <td>ERZVF□M220 to ERZVF□M680</td> <td>8/20 μs</td> <td>5 A</td> </tr> <tr> <td>ERZVF□M820 to ERZVF□M271</td> <td>8/20 μs</td> <td>25 A</td> </tr> <tr> <td>ERZVF□M331 to ERZVF□M471</td> <td>8/20 μs</td> <td>20 A</td> </tr> <tr> <td rowspan="2">VF□T</td> <td>ERZVF□T820 to ERZVF□T271</td> <td>8/20 μs</td> <td>14 A</td> </tr> <tr> <td rowspan="2">CF</td> <td>ERZCF□MK220 to ERZCF□MK680</td> <td>2 ms</td> <td>0.45 A</td> </tr> <tr> <td></td> <td>ERZCF□MK820 to ERZCF□MK471</td> <td>8/20 μs</td> <td>14 A</td> </tr> <tr> <td rowspan="3">SF</td> <td>ERZSF□MK220 to ERZSF□MK680</td> <td>8/20 μs</td> <td>12 A</td> </tr> <tr> <td>ERZSF□MK820 to ERZSF□MK271</td> <td>8/20 μs</td> <td>35 A</td> </tr> <tr> <td>ERZSF□MK331 to ERZSF□MK471</td> <td>8/20 μs</td> <td>28 A</td> </tr> </tbody> </table>	Type	Part Number	Waveform	Current	VF□M	ERZVF□M220 to ERZVF□M680	8/20 μ s	5 A	ERZVF□M820 to ERZVF□M271	8/20 μ s	25 A	ERZVF□M331 to ERZVF□M471	8/20 μ s	20 A	VF□T	ERZVF□T820 to ERZVF□T271	8/20 μ s	14 A	CF	ERZCF□MK220 to ERZCF□MK680	2 ms	0.45 A		ERZCF□MK820 to ERZCF□MK471	8/20 μ s	14 A	SF	ERZSF□MK220 to ERZSF□MK680	8/20 μ s	12 A	ERZSF□MK820 to ERZSF□MK271	8/20 μ s	35 A	ERZSF□MK331 to ERZSF□MK471	8/20 μ s	28 A	$\Delta V_{CmA}/V_{CmA} \leq \pm 10$ %
Type	Part Number	Waveform	Current																																			
VF□M	ERZVF□M220 to ERZVF□M680	8/20 μ s	5 A																																			
	ERZVF□M820 to ERZVF□M271	8/20 μ s	25 A																																			
	ERZVF□M331 to ERZVF□M471	8/20 μ s	20 A																																			
VF□T	ERZVF□T820 to ERZVF□T271	8/20 μ s	14 A																																			
	CF	ERZCF□MK220 to ERZCF□MK680	2 ms	0.45 A																																		
		ERZCF□MK820 to ERZCF□MK471	8/20 μ s	14 A																																		
SF	ERZSF□MK220 to ERZSF□MK680	8/20 μ s	12 A																																			
	ERZSF□MK820 to ERZSF□MK271	8/20 μ s	35 A																																			
	ERZSF□MK331 to ERZSF□MK471	8/20 μ s	28 A																																			

Looking for pricing, stock, or lifecycle information?

Click below to explore more details on WIN SOURCE:

-  [View ERZ-SF2MK820 on WIN SOURCE](#)
-  [Panasonic Information](#)

Optimize Your Supply Chain with WIN SOURCE Solutions

-  Global Sourcing Solution
-  Obsolete Management
-  Cost Control Management
-  Shortage Management
-  Alternative Solution
-  Excess Inventory Management