



**THE DATASHEET OF
1273AS-H-220M=P3**



DEM8030C / DEM8040C / DEM8045C

Inductance Range: 1.5~47μH(DEM8030C), 1.5~33μH(DEM8040C), 1.5~47μH(DEM8045C)

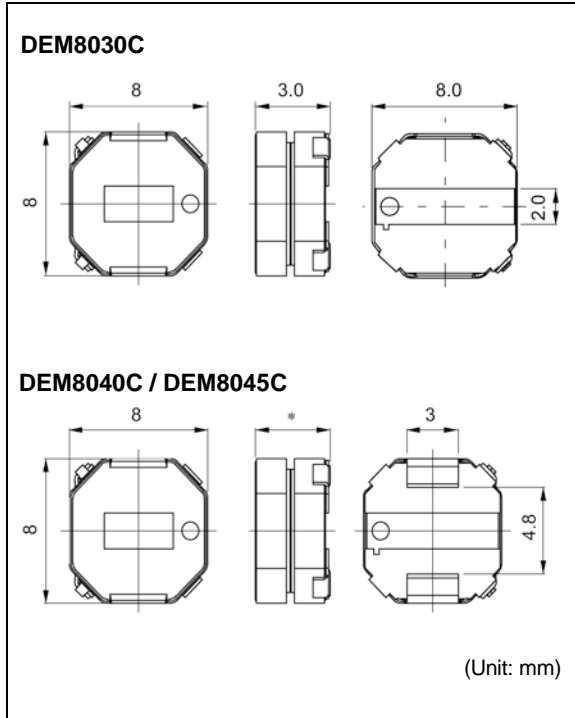
Recommended patterns
 推荐焊盘尺寸

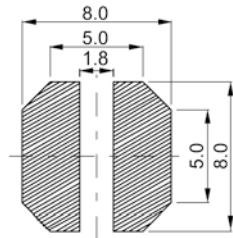
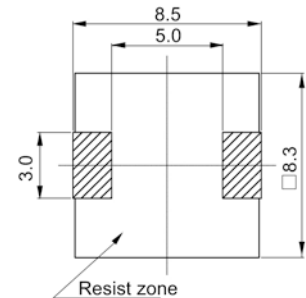
DEM8030C

DEM8040C / DEM8045C

(Unit: mm)

*: DEM8040C ; 4.0mm Max.

DEM8045C ; 4.5mm Max.

FEATURES 特点

- 8.3×8.3mm Max. square, 3.0, 4.0, and 4.5mm Max. height.
- Magnetically shielded construction and low DC resistance.
- Suitable for large currents.
- RoHS compliant.
- Halogen Free
- 最大8.3×8.3毫米的平面，最大高度3.0 / 4.0 / 4.5毫米
- 磁性屏蔽结构和低直流电阻
- 适合大电流
- 符合RoHS指令
- 无卤素

STANDARD PART NUMBERS 标准零件号码
TYPE DEM8030C (Quantity/reel; 1000 PCS)

| 零件号码 | 电感值 ⁽¹⁾ | 公差 | 最大直流电阻 ⁽²⁾ (典型) | 最大电感值减小电流 ⁽³⁾ (典型) | 最大温度上升电流 ⁽³⁾ (典型) |
|------------------|--------------------------------|---------------|---|---|--|
| Part Number | Inductance ⁽¹⁾ (μH) | Tolerance (%) | DC Resistance ⁽²⁾ (mΩ) Max. (Typ.) | Inductance Decrease Current ⁽³⁾ (A) Max. (Typ.) $\frac{\Delta L}{L} = 30\%$ | Temperature Rise Current ⁽³⁾ (A) Max. (Typ.) $\Delta T = 40^\circ\text{C}$ |
| 1273AS-H-1R5N=P3 | 1.5 | ±30 | 10.0 (8.3) | 7.5(10) | 7.3(8.6) |
| 1273AS-H-2R2N=P3 | 2.2 | ±30 | 13.2 (11) | 6.2(8.2) | 6.5(7.7) |
| 1273AS-H-3R3N=P3 | 3.3 | ±30 | 19.2 (16) | 5.2(6.9) | 5.4(6.3) |
| 1273AS-H-4R7N=P3 | 4.7 | ±30 | 22.8 (19) | 4.4(5.9) | 4.9(5.8) |
| 1273AS-H-6R8N=P3 | 6.8 | ±30 | 37.2 (31) | 3.4(4.5) | 3.7(4.4) |
| 1273AS-H-100M=P3 | 10 | ±20 | 54.0 (45) | 2.9(3.8) | 3.1(3.6) |
| 1273AS-H-150M=P3 | 15 | ±20 | 78.0 (65) | 2.4(3.2) | 2.6(3.1) |
| 1273AS-H-220M=P3 | 22 | ±20 | 126.0 (105) | 2.0 (2.7) | 2.0 (2.4) |
| 1273AS-H-330M=P3 | 33 | ±20 | 174.0 (145) | 1.6 (2.1) | 1.9 (2.2) |
| 1273AS-H-470M=P3 | 47 | ±20 | 289.0 (241) | 1.3(1.7) | 1.3(1.5) |

continued on next page 接下页

continued from previous page 接上页

STANDARD PART NUMBERS 标准零件号码
TYPE DEM8040C (Quantity/reel; 1000 PCS)

| 零件号码 | 电感值 ⁽¹⁾ | 公差 | 最大直流电阻 ⁽²⁾ (典型) | 最大电感值减小电流 ⁽³⁾ (典型) | 最大温度上升电流 ⁽³⁾ (典型) |
|------------------|--------------------------------|---------------|---|---|---|
| Part Number | Inductance ⁽¹⁾ (μH) | Tolerance (%) | DC Resistance ⁽²⁾ (mΩ) Max. (Typ.) | Inductance Decrease Current ⁽³⁾ (A) Max. (Typ.) $\frac{\Delta L}{L} = 30\%$ | Temperature Rise Current ⁽³⁾ ΔT=40°C (A) Max. (Typ.) |
| 1248AS-H-1R5N=P3 | 1.5 | ±30 | 10.1 (8.4) | 10.0 (14.0) | 8.0 (9.4) |
| 1248AS-H-2R2N=P3 | 2.2 | ±30 | 13.2 (11) | 8.6 (12.0) | 7.0 (8.3) |
| 1248AS-H-3R3N=P3 | 3.3 | ±30 | 19.2 (16) | 7.2 (9.4) | 5.6 (6.6) |
| 1248AS-H-4R7N=P3 | 4.7 | ±30 | 22.8 (19) | 6.2 (8.4) | 5.3 (6.2) |
| 1248AS-H-6R8N=P3 | 6.8 | ±30 | 36.0 (30) | 4.8 (6.6) | 4.2 (4.9) |
| 1248AS-H-100M=P3 | 10 | ±20 | 52.8 (44) | 4.1 (5.4) | 3.4 (4.0) |
| 1248AS-H-150M=P3 | 15 | ±20 | 78.0 (65) | 3.4 (4.6) | 2.7 (3.2) |
| 1248AS-H-220M=P3 | 22 | ±20 | 126.0 (105) | 2.8 (3.7) | 2.2 (2.6) |
| 1248AS-H-330M=P3 | 33 | ±20 | 168.0 (140) | 2.4 (3.1) | 1.8 (2.2) |

TYPE DEM8045C (Quantity/reel; 1000 PCS)

| 零件号码 | 电感值 ⁽¹⁾ | 公差 | 最大直流电阻 ⁽²⁾ (典型) | 最大电感值减小电流 ⁽³⁾ (典型) | 最大温度上升电流 ⁽³⁾ (典型) |
|------------------|--------------------------------|---------------|---|---|---|
| Part Number | Inductance ⁽¹⁾ (μH) | Tolerance (%) | DC Resistance ⁽²⁾ (mΩ) Max. (Typ.) | Inductance Decrease Current ⁽³⁾ (A) Max. (Typ.) $\frac{\Delta L}{L} = 30\%$ | Temperature Rise Current ⁽³⁾ ΔT=40°C (A) Max. (Typ.) |
| 1217AS-H-1R5N=P3 | 1.5 | ±30 | 7.6 (6.5) | 11.2 (15.0) | 9.4 (11.0) |
| 1217AS-H-2R2N=P3 | 2.2 | ±30 | 9.9 (8.3) | 9.3 (12.4) | 8.7 (10.0) |
| 1217AS-H-3R3N=P3 | 3.3 | ±30 | 14.4 (12) | 7.7 (10.3) | 6.8 (8.0) |
| 1217AS-H-4R7N=P3 | 4.7 | ±30 | 18.0 (15) | 6.7 (9.0) | 6.3 (7.4) |
| 1217AS-H-5R6N=P3 | 5.6 | ±30 | 22.8 (19) | 6.1 (8.1) | 5.4 (6.4) |
| 1217AS-H-6R8N=P3 | 6.8 | ±30 | 27.6 (23) | 5.2 (7.0) | 4.8 (5.6) |
| 1217AS-H-8R2M=P3 | 8.2 | ±20 | 33.6 (28) | 4.8 (6.4) | 4.5 (5.3) |
| 1217AS-H-100M=P3 | 10 | ±20 | 39.6 (33) | 4.3 (5.7) | 3.9 (4.6) |
| 1217AS-H-150M=P3 | 15 | ±20 | 52.8 (44) | 3.3 (4.4) | 3.5 (4.1) |
| 1217AS-H-180M=P3 | 18 | ±20 | 76.8 (64) | 3.2 (4.3) | 2.9 (3.4) |
| 1217AS-H-220M=P3 | 22 | ±20 | 93.6 (78) | 2.9 (3.9) | 2.4 (2.8) |
| 1217AS-H-330M=P3 | 33 | ±20 | 132.0 (110) | 2.3 (3.1) | 2.2 (2.6) |
| 1217AS-H-470M=P3 | 47 | ±20 | 204.0 (170) | 2.1 (2.8) | 1.8 (2.1) |

(1) Inductance is measured with a LCR meter 4284A (Agilent Technologies) or equivalent. Test frequency at 100kHz

(2) DC resistance is measured with 34420A (Agilent Technologies) or 3541(HIOKI). (Reference ambient temperature 25°C)

(3) Maximum allowable DC current is that which causes a 30% inductance reduction from the initial value, or coil temperature to rise by 40°C, whichever is smaller. (Reference ambient temperature 20°C)



(1) LCR仪表4284A (Agilent技术)或者功能相同的仪器在100kHz下测试电感值。

(2) 通过数码万用表34420A (Agilent技术) 或者3541(HIOKI)测试直流电阻。(环境温度为25°C)





(3) 允许最大直流电的范围是以下两者中比较小的一个: 引起电感值从最初值降低30%, 或者线圈温度升高40°C。(参考周围环境温度20°C)。

Looking for pricing, stock, or lifecycle information?

Click below to explore more details on WIN SOURCE:

-  [View 1273AS-H-220M=P3 on WIN SOURCE](#)
-  [Murata Electronics North America Information](#)

Optimize Your Supply Chain with WIN SOURCE Solutions

-  Global Sourcing Solution
-  Obsolete Management
-  Cost Control Management
-  Shortage Management
-  Alternative Solution
-  Excess Inventory Management