



**THE DATASHEET OF
1290310000**



Preliminary product data

S2C-SMT 3.50/././90

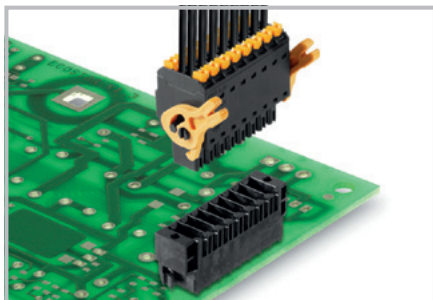

High-temperature-resistant male header for side-by-side mounting.

- Touch-safe
- Pluggable to the female plug B2CF 3.50 PUSH IN
- Plugging direction parallel to PCB (recumbent)
- Housing variants: closed (G) and with solder flange (LF).
- Packed in a carton (BX)
- 3.2-mm pin length suitable for reflow and wave soldering.

Product data

IEC: 200 V / 10 A
UL: 150 V / 10 A

For additional articles and information, refer to catalog.weidmueller.com

Note:

- Gold-plated contact surface on request
- Tape packaged on request
- See hole pattern for distance between rows
- Rated voltage referenced to rated cross-section and minimum poles
- P on drg. = pitch
- Rated data relate to the respective component. Clearance and creepage distances to other components must be set in accordance with the relevant application standard.

S2C-SMT 3.50/././90G Box

Closed side



Dimensioned drawing

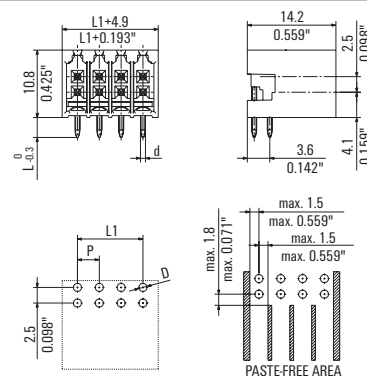



Technical data

In compliance with IEC 60664-1 / IEC 61984			
Clamping range, max.	mm ²		
Solid core H05(07) V-U	mm²		
Stranded H07 V-R			
Flexible H05(07) V-K	mm ²		
Flexible with ferrule	mm ²		
Ferrule with plastic collar	mm ²		
Stripping length	mm		
Screwdriver blade	mm		
According to norm			
Tightening torque range	Nm		
Rated current, max.	A	10	9
At ambient temperature		20°C	40°C
For conductor cross-section	mm ²	1,5	
Overtoltage category		III	III II
Pollution severity		3	2 2
Rated voltage	V	80	160 200
Rated impulse voltage	kV	2,5	2,5 2,5
UL / CUL (Use Group)		B	C D
Rated voltage	V	150	50
Rated current	A	10	10
AWG conductor	AWG		-
CSA (Use Group)		B	C D
Rated voltage	V	150	
Rated current	A	10	
AWG conductor	AWG		-
General data			
Type of insulation material		LCP GF	
Flammability class UL 94		V-0	
Contact base material		Copper alloy	
Material of contact surface		tinned	
Pin dimensions = d	mm	1,0, Octagonal	
Solder eyelet Ø = D	mm	1,3	
Solder eyelet Ø tolerance	mm	+ 0,1	

Accessories

Note: Refer to the Accessories chapter for additional accessories.

Coding		Order No.
	B2L/S2L 3.5 KO OR	1849730000
	B2L/S2L 3.5 KO SW	1849740000
	S2L-SMT 3.5 FLA 20/10	1814590000

Ordering data

Solder pin length		1,5 mm		3,2 mm	
Colour		black		black	
Pitch 3,50 mm					
Pol.	L1	(inch)	Qty.	Order No.	Order No.
4	3,50	0,138	50	1289630000	1288980000
6	7,00	0,276	50	1289640000	1289270000
8	10,50	0,413	50	1289650000	1289280000
10	14,00	0,551	50	1289670000	1289290000
12	17,50	0,689	50	1289680000	1289300000
14	21,00	0,827	50	1289700000	1289310000
16	24,50	0,965	50	1289710000	1289320000
18	28,00	1,102	20	1289720000	1289330000
20	31,50	1,240	20	1289730000	1289340000
22	35,00	1,378	20	1289740000	1289350000
24	38,50	1,516	20	1289750000	1289370000
26	42,00	1,654	20	1289770000	1289380000
28	45,50	1,791	20	1289780000	1289390000
30	49,00	1,929	20	1289790000	1289410000
32	52,50	2,067	20	1289800000	1289420000
34	56,00	2,205	20	1289810000	1289430000
36	59,50	2,343	20	1289820000	1289440000

S2C-SMT 3.50/./90LF Box

With solder flange



Dimensioned drawing

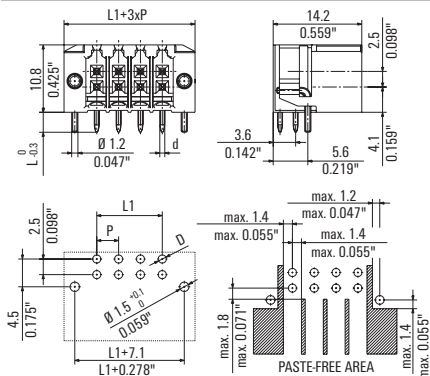

Ordering data

Solder pin length		1,5 mm	3,2 mm		
Colour		black	black		
Pitch 3,50 mm					
Pol.	L1 (inch)	Qty.	Order No.		
4	3,50	0,138	50	1289830000	1289450000
6	7,00	0,276	50	1289840000	1289460000
8	10,50	0,413	50	1289850000	1289470000
10	14,00	0,551	50	1289870000	1289480000
12	17,50	0,689	50	1289880000	1289490000
14	21,00	0,827	50	1289890000	1289500000
16	24,50	0,965	50	1289910000	1289510000
18	28,00	1,102	20	1289930000	1289520000
20	31,50	1,240	20	1289940000	1289530000
22	35,00	1,378	20	1289950000	1289540000
24	38,50	1,516	20	1289960000	1289550000
26	42,00	1,654	20	1289970000	1289570000
28	45,50	1,791	20	1289980000	1289580000
30	49,00	1,929	20	1289990000	1289590000
32	52,50	2,067	20	1290000000	1289600000
34	56,00	2,205	20	1290010000	1289610000
36	59,50	2,343	20	1290020000	1289620000

S2C-SMT 3.50/./180G Box

Closed side



Dimensioned drawing

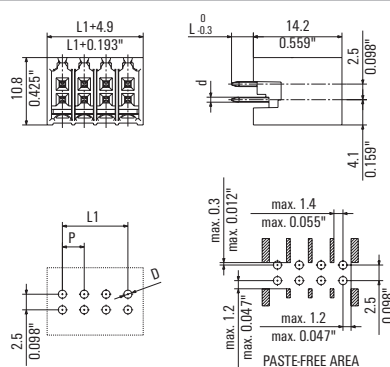

Ordering data

Solder pin length		1,5 mm	3,5 mm		
Colour		black	black		
Pitch 3,50 mm					
Pol.	L1 (inch)	Qty.	Order No.		
4	3,50	0,138	50	1290410000	1290030000
6	7,00	0,276	50	1290420000	1290040000
8	10,50	0,413	50	1290430000	1290050000
10	14,00	0,551	50	1290440000	1290060000
12	17,50	0,689	50	1290450000	1290070000
14	21,00	0,827	50	1290460000	1290080000
16	24,50	0,965	50	1290470000	1290090000
18	28,00	1,102	20	1290480000	1290110000
20	31,50	1,240	20	1290490000	1290120000
22	35,00	1,378	20	1290510000	1290130000
24	38,50	1,516	20	1290520000	1290140000
26	42,00	1,654	20	1290530000	1290150000
28	45,50	1,791	20	1290540000	1290160000
30	49,00	1,929	20	1290550000	1290170000
32	52,50	2,067	20	1290560000	1290180000
34	56,00	2,205	20	1290570000	1290190000
36	59,50	2,343	20	1290580000	1290210000

S2C-SMT 3.50/./180LF Box

With solder flange

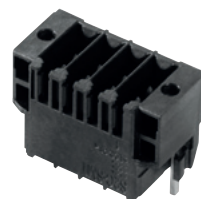

Dimensioned drawing

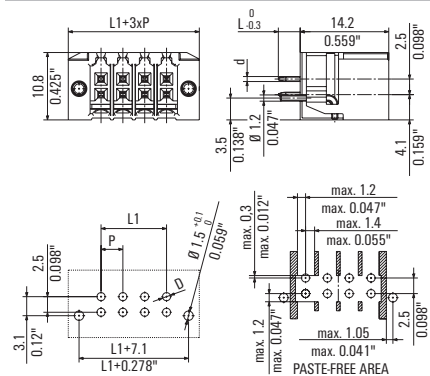

Ordering data

Solder pin length		1,5 mm	3,5 mm		
Colour		black	black		
Pitch 3,50 mm					
Pol.	L1 (inch)	Qty.	Order No.		
4	3,50	0,138	50	1290590000	1290220000
6	7,00	0,276	50	1290610000	1290230000
8	10,50	0,413	50	1290620000	1290240000
10	14,00	0,551	50	1290640000	1290250000
12	17,50	0,689	50	1290650000	1290260000
14	21,00	0,827	50	1290660000	1290270000
16	24,50	0,965	50	1290670000	1290280000
18	28,00	1,102	20	1290680000	1290290000
20	31,50	1,240	20	1290690000	1290310000
22	35,00	1,378	20	1290710000	1290320000
24	38,50	1,516	20	1290720000	1290330000
26	42,00	1,654	20	1290730000	1290340000
28	45,50	1,791	20	1290740000	1290350000
30	49,00	1,929	20	1290750000	1290360000
32	52,50	2,067	20	1290760000	1290370000
34	56,00	2,205	20	1290770000	1290380000
36	59,50	2,343	20	1290780000	1290390000

Preliminary product data

B2C 3.50/././180

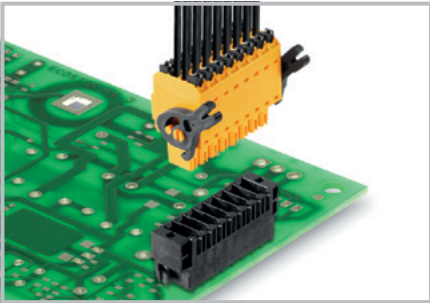

Double female plug with PUSH IN wire connection.

- Simply insert the prepared wire and it's ready.
- Intuitive handling – since the wire-entry area and handling area are clearly separated.
- Integrated push-button for opening the terminal point
- High component density because of low heights
- Optional: the lock and release requires no tools when using Weidmüller's patented (LR) release latch.
- Approval according to IEC 60335 and GL pending

Product data

IEC: 320 V / 10 A / 0,14 - 1,5 mm²
 UL: 300 V / 10 A / AWG 26 - AWG 16

For additional articles and information, refer to catalog.weidmueller.com

Note:

- Gold-plated contact surface on request
- Crimping shape „A“ for wire end ferrules with PZ 1,5 crimping tools Order No. 9005990000 or PZ 6/5 Order No. 9011460000 recommended for the largest conductor cross-section
- Rated voltage referenced to rated cross-section and minimum poles
- Wire end ferrule without plastic collar to DIN 46228/1
- Wire end ferrule with plastic collar to DIN 46228/4
- P on drg. = pitch
- Rated data refer only to the component itself. Clearance and creepage distances to other components are to be designed in accordance with the relevant application standards.
- Compatible with Series S2L 3.50, S2L-SMT 3.50 and S2L 3.50

B2CF 3.50/././180



Dimensioned drawing

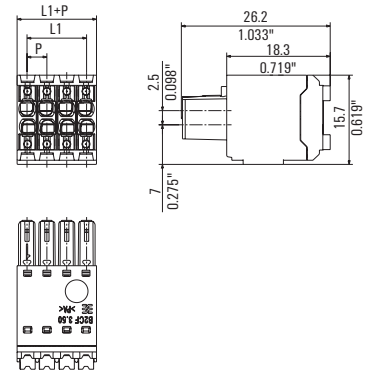

Technical data

In compliance with IEC 60664-1 / IEC 61984			
Clamping range, max.	mm ²	0,14...1,5	
Solid core H05(07) V-U	mm²	0,14...1,5	
Stranded H07 V-R			
Flexible H05(07) V-K	mm ²	0,14...1,5	
Flexible with ferrule	mm ²	0,14...1,5	
Ferrule with plastic collar	mm ²	0,14...1	
Stripping length	mm	12	
Screwdriver blade	mm		
According to norm			
Tightening torque range	Nm		
Rated current, max.	A	10,3	8,9
At ambient temperature		20°C	40°C
For conductor cross-section	mm ²	1	
Overvoltage category		III	III II
Pollution severity		3	2 2
Rated voltage	V	160	160 320
Rated impulse voltage	kV	2,5	2,5 2,5
UL / CUL (Use Group)	B C D		
Rated voltage	V		
Rated current	A		
AWG conductor	AWG		
CSA (Use Group)	B C D		
Rated voltage	V	300	
Rated current	A	5	
AWG conductor	AWG	26-16	
General data			
Type of insulation material		PA 66 GF 30	
Flammability class UL 94		V-0	
Contact base material		Copper alloy	
Material of contact surface		tinned	
Pin dimensions = d	mm		
Solder eyelet Ø = D	mm		
Solder eyelet Ø tolerance	mm		

Accessories

Note: Refer to the Accessories chapter for additional accessories.

Coding	Order No.
B2L/S2L 3.5 KO OR	1849730000
B2L/S2L 3.5 KO SW	1849740000
Strain relief	
BL 3.5 ZE 3 OR	1629680000
BL 3.5 ZE 3 SW	1627820000
BL 3.5 ZE 8 OR	1629690000
BL 3.5 ZE 8 SW	1627830000
Screwdriver	
SD 0,4x2,5x75	9009030000
Crimping tool	
PZ 1,5	9005990000
PZ 6/5	9011460000

Ordering data

Solder pin length					
Colour		orange	black		
Pitch 3,50 mm					
Pol.	L1	(inch)	Qty.	Order No.	Order No.
4	3,50	0,138	50	1277270000	1277460000
6	7,00	0,276	50	1277280000	1277470000
8	10,50	0,413	50	1277290000	1277480000
10	14,00	0,551	50	1277310000	1277490000
12	17,50	0,689	50	1277320000	1277510000
14	21,00	0,827	50	1277330000	1277520000
16	24,50	0,965	50	1277340000	1277530000
18	28,00	1,102	20	1277350000	1277540000
20	31,50	1,240	20	1277360000	1277550000
22	35,00	1,378	20	1277370000	1277560000
24	38,50	1,516	20	1277380000	1277570000
26	42,00	1,654	20	1277390000	1277580000
28	45,50	1,791	20	1277410000	1277590000
30	49,00	1,929	20	1277420000	1277610000
32	52,50	2,067	20	1277430000	1277620000
34	56,00	2,205	20	1277440000	1277630000
36	59,50	2,343	20	1277450000	1277640000

Representative derating curve

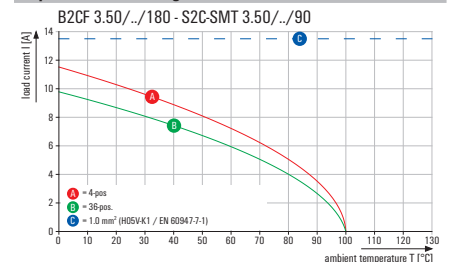

B2CF 3.50/././180F

With flange



B2CF 3.50/././180LR

With release lever



Dimensioned drawing

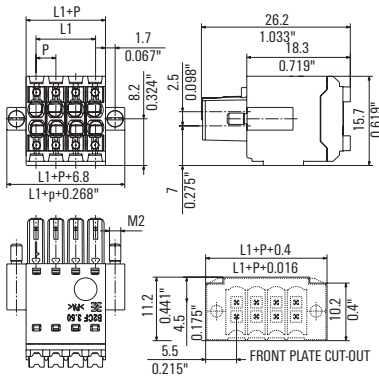

Dimensioned drawing

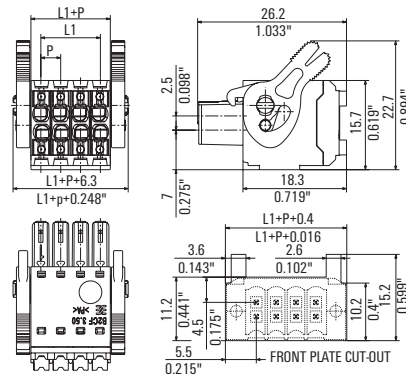

Ordering data



Solder pin length					
Colour		orange	black		
Pitch 3,50 mm					
Pol.	L1	(inch)	Qty.	Order No.	Order No.
4	3,50	0,138	50	1277650000	1277860000
6	7,00	0,276	50	1277670000	1277870000
8	10,50	0,413	50	1277680000	1277880000
10	14,00	0,551	50	1277690000	1277890000
12	17,50	0,689	50	1277720000	1277900000
14	21,00	0,827	50	1277730000	1277910000
16	24,50	0,965	50	1277740000	1277920000
18	28,00	1,102	20	1277750000	1277930000
20	31,50	1,240	20	1277760000	1277940000
22	35,00	1,378	20	1277770000	1277950000
24	38,50	1,516	20	1277780000	1277970000
26	42,00	1,654	20	1277790000	1277980000
28	45,50	1,791	20	1277810000	1277990000
30	49,00	1,929	20	1277820000	1278000000
32	52,50	2,067	20	1277830000	1278010000
34	56,00	2,205	20	1277840000	1278020000
36	59,50	2,343	20	1277850000	1278030000

Ordering data

Solder pin length					
Colour		orange	black		
Pitch 3,50 mm					
Pol.	L1	(inch)	Qty.	Order No.	Order No.
4	3,50	0,138	50	1278040000	1278230000
6	7,00	0,276	50	1278050000	1278240000
8	10,50	0,413	50	1278060000	1278250000
10	14,00	0,551	50	1278070000	1278260000
12	17,50	0,689	50	1278080000	1278270000
14	21,00	0,827	50	1278090000	1278280000
16	24,50	0,965	50	1278100000	1278290000
18	28,00	1,102	20	1278110000	1278300000
20	31,50	1,240	20	1278120000	1278310000
22	35,00	1,378	20	1278130000	1278320000
24	38,50	1,516	20	1278140000	1278340000
26	42,00	1,654	20	1278150000	1278350000
28	45,50	1,791	20	1278170000	1278370000
30	49,00	1,929	20	1278180000	1278380000
32	52,50	2,067	20	1278190000	1278390000
34	56,00	2,205	20	1278200000	1278400000
36	59,50	2,343	20	1278210000	1278410000

Looking for pricing, stock, or lifecycle information?

Click below to explore more details on WIN SOURCE:

-  [View 1290310000 on WIN SOURCE](#)
-  [Weidmuller Information](#)

Optimize Your Supply Chain with WIN SOURCE Solutions

-  Global Sourcing Solution
-  Obsolete Management
-  Cost Control Management
-  Shortage Management
-  Alternative Solution
-  Excess Inventory Management