



**THE DATASHEET OF
DML3008LFDS-7**



Description

The DML3008LFDS load switch provides a component and area-reducing solution for efficient power domain switching. In addition to integrated control functionality with ultra-low on-resistance, this device offers system safeguards and monitoring via fault protection and power good signaling. This cost effective solution is ideal for power management and hot-swap applications requiring low power consumption in a small footprint.

Applications

- Portable electronics and systems
- Notebooks and tablet computers
- Telecoms, networking, medical and industrial equipment
- Set-top boxes, servers and gateways
- Hot-swap devices and peripheral ports

Features and Benefits

- Advanced Controller with ChargePump
 - Integrated N-Channel MOSFET with Ultra-Low R_{ON}
 - Input Voltage Range 0.5V to 20V
 - Internal Slew Rate Controller
 - Power Good Signal
 - Thermal Shutdown
 - Extremely Low Standby Current
 - Load Bleed (Quick Discharge)
 - **Totally Lead-Free & Fully RoHS Compliant (Notes 1 & 2)**
 - **Halogen and Antimony Free. "Green" Device (Note 3)**
 - **For automotive applications requiring specific change control (i.e. parts qualified to AEC-Q100/101/104/200, PPAP capable, and manufactured in IATF 16949 certified facilities), please [contact us](https://www.diodes.com/quality/product-definitions/) or your local Diodes representative.**
- <https://www.diodes.com/quality/product-definitions/>

Mechanical Data

- Package: V-DFN2020-8
- Package Material: Molded Plastic, "Green" Molding Compound. UL Flammability Classification Rating 94V-0
- Moisture Sensitivity: Level 1 per J-STD-020
- Terminals: Finish — NiPdAu over Copper Leadframe. Solderable per MIL-STD-202, Method 208@4
- Weight: 0.011 grams (Approximate)

V-DFN2020-8 (Type N)



Top View

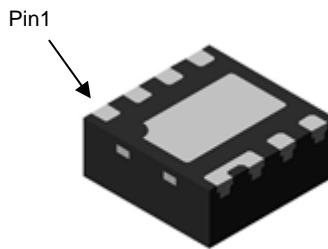

Bottom View

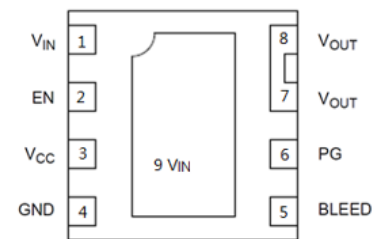

Top View

Ordering Information (Note 4)

Part Number	Package	Packing	
		Qty.	Carrier
DML3008LFDS-7	V-DFN2020-8 (Type N)	3,000	Tape & Reel

- Notes:
1. No purposely added lead. Fully EU Directive 2002/95/EC (RoHS), 2011/65/EU (RoHS 2) & 2015/863/EU (RoHS 3) compliant.
 2. See <https://www.diodes.com/quality/lead-free/> for more information about Diodes Incorporated's definitions of Halogen- and Antimony-free, "Green" and Lead-free.
 3. Halogen- and Antimony-free "Green" products are defined as those which contain <900ppm bromine, <900ppm chlorine (<1500ppm total Br + Cl) and <1000ppm antimony compounds.
 4. For packaging details, go to our website at <https://www.diodes.com/design/support/packaging/diodes-packaging/>.

Marking Information

Site 1:

V-DFN2020-8 (Type N)

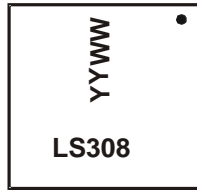

LS308 = Product Type Marking Code
 YYWW = Date Code Marking
 YY = Last Two Digits of Year (ex: 24 = 2024)
 WW = Week Code (01 to 53)

Site 2:

V-DFN2020-8 (Type N)

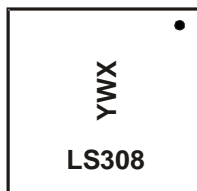

LS308 = Product Type Marking Code
 YWX = Date Code Marking
 Y = Year (ex: 4 = 2024)
 W = Week (ex: a = Week 27; z Represents Week 52 and 53)
 X = Internal Code (ex: U = Monday)

Date Code Key

Year	2020	...	2024	2025	2026	2027	2028	2029	2030	2031	2032	2033
Code	0	...	4	5	6	7	8	9	0	1	2	3

Week	1-26	27-52	53
Code	A-Z	a-z	z

Internal Code	Sun	Mon	Tue	Wed	Thu	Fri	Sat
Code	T	U	V	W	X	Y	Z

Typical Application Circuit

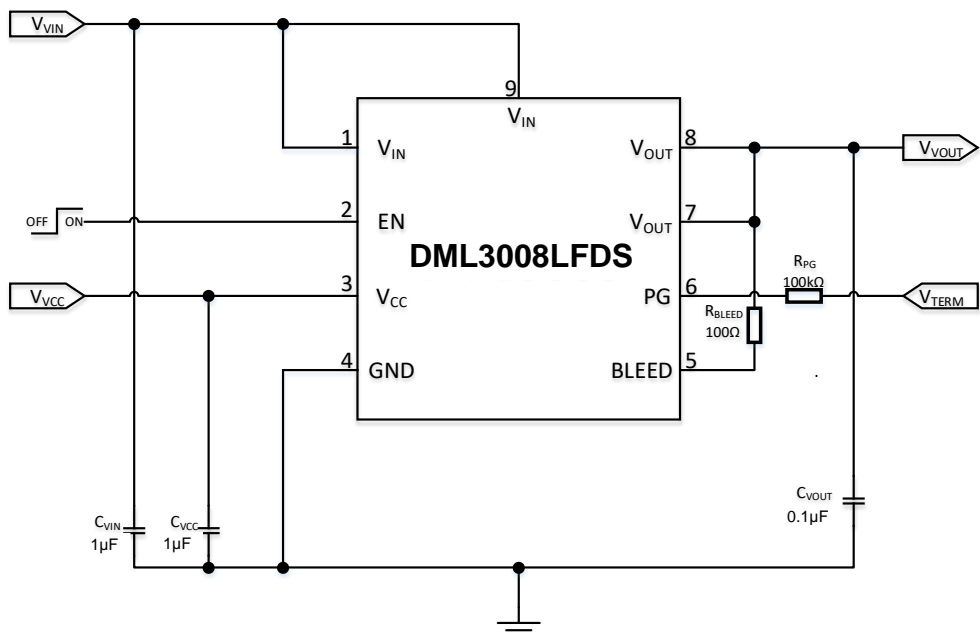

Pin Description

Pin Number	Pin Name	Pin Function
1, 9	V _{IN}	Drain of internal MOSFET (0.5V to 20V), Pin 1 must be connected to Pin 9
2	EN	Active-high digital input used to turn on the MOSFET, this pin has an internal pull down resistor to GND
3	V _{CC}	Supply voltage to controller (3.0V to 5.5V)
4	GND	Controller ground
5	BLEED	Load bleed connection, must be tied to V _{OUT} through a resistor ≤ 100MΩ
6	PG	Active-high, open-drain output that indicates when the gate of the MOSFET is fully charged, external pull up resistor ≥ 1kΩ to an external voltage source required; tie to GND if not used.
7, 8	V _{OUT}	Source of internal MOSFET connected to load

Functional Block Diagram

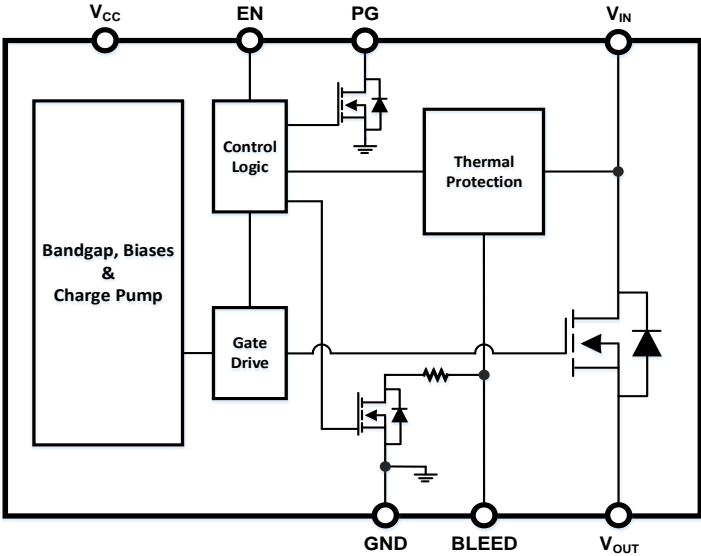

Absolute Maximum Rating

Parameter	Rating
V _{IN} , BLEED, V _{OUT} to GND	-0.3V to 24V
EN, V _{CC} , PG to GND	-0.3V to 6V
I _{MAX}	10.5A
Storage Temperature (T _s)	-65°C to +150°C
ESD Capability, Human Body Model	2kV
ESD Capability, Charge Device Model	500V

Recommended Operating Ranges

Parameter	Rating
Supply Voltage (V _{CC})	3V to 5.5V
Input Voltage (V _{IN})	0.5V to 20V
Ambient Temperature (T _A)	-40°C to +85°C
Junction Temperature (T _J)	-40°C to +125°C
Package Thermal Resistance (θ _{JC})	5.3°C/W
Package Thermal Resistance (θ _{JA})	40°C/W

Electrical Characteristics (T_A = +25°C, V_{VCC} = 3.3V, V_{VIN} = 5V = V_{TERM}, C_{VIN} = 1μF, C_{VOUT} = 0.1μF, C_{VCC} = 1μF, C_{SR} = 1nF, unless otherwise specified.)

Symbol	Parameter	Conditions	Min	Typ	Max	Unit
V _{IN}	Input Voltage	—	0.5	—	20	V
V _{CC}	Supply Voltage	—	3.0	—	5.5	V
I _{DYN}	V _{CC} Dynamic Supply Current	V _{EN} = V _{CC} = 3V, V _{IN} = 12V	—	150	250	μA
		V _{EN} = V _{CC} = 5.5V, V _{IN} = 1.8V	—	190	350	μA
I _{STBY}	V _{CC} Shutdown Supply Current	V _{CC} = 3V, V _{EN} = 0V	—	0.1	1	μA
		V _{CC} = 5.5V, V _{EN} = 0V	—	0.1	2	μA
V _{ENH}	EN High Level Voltage	V _{CC} = 3V to 5.5V	2.0	—	—	V
V _{ENL}	EN Low Level Voltage	V _{CC} = 3V to 5.5V	—	—	0.8	V
R _{BLEED}	Bleed Resistance	V _{CC} = 3V, V _{EN} = 0V	90	120	150	Ω
		V _{CC} = 5.5V, V _{EN} = 0V	70	100	130	Ω
I _{BLEED}	Bleed Pin Leakage Current (Note 5)	V _{CC} = V _{EN} = 3V, V _{IN} = 1.8V	—	0.3	—	μA
		V _{CC} = V _{EN} = 3V, V _{IN} = 20V	—	0.5	—	μA
V _{PGL}	PG Output Low Voltage	V _{CC} = 3V, I _{SINK} = 5mA	—	—	0.2	V
I _{PG}	PG Output Leakage Current	V _{CC} = 3V, V _{TERM} = 3.3V	—	—	100	nA
Switching Device						
R _{ON}	Switch On-State Resistance	V _{CC} = 3.3V, V _{IN} = 1.8V	—	9	12.5	mΩ
		V _{CC} = 3.3V, V _{IN} = 5V	—	9	12.5	mΩ
		V _{CC} = 3.3V, V _{IN} = 12V	—	9	12.5	mΩ
		V _{CC} = 5V, V _{IN} = 1.8V	—	7.5	10.5	mΩ
		V _{CC} = 5V, V _{IN} = 5V	—	7.5	10.5	mΩ
		V _{CC} = 5V, V _{IN} = 12V	—	7.5	10.5	mΩ
I _{LEAK}	Input Shutdown Supply Current	V _{EN} = 0V, V _{IN} = 24V	—	—	20	μA
R _{PDEN}	EN Pull Down Resistance	—	50	100	150	kΩ
Fault Protection						
T _{OTP}	Thermal Shutdown Threshold	V _{CC} = 3V to 5.5V	—	+145	—	°C
T _{OTPHYS}	Thermal Shutdown Hysteresis	V _{CC} = 3V to 5.5V	—	+20	—	°C
V _{UVLO}	V _{CC} Lockout Threshold	—	2.3	2.55	2.8	V
V _{UVLOHYS}	V _{CC} Lockout Hysteresis	—	—	200	—	mV

Note: 5. Guaranteed by design. Not subject to production testing.

Switching Characteristics ($T_A = +25^\circ\text{C}$, $V_{\text{TERM}} = V_{\text{CC}} = 5\text{V}$, $R_{\text{PG}} = 100\text{k}\Omega$, $R_{\text{VOUT}} = 10\Omega$, $C_{\text{VIN}} = 1\mu\text{F}$, $C_{\text{VOUT}} = 0.1\mu\text{F}$, $C_{\text{VCC}} = 1\mu\text{F}$, $R_{\text{BLEED}} = 100\Omega$, unless otherwise specified.)

Symbol	Parameter	Condition	Min	Typ	Max	Unit
$V_{\text{IN}} = 1.8\text{V}$						
t_{OND}	Output Turn-On Delay Time	$V_{\text{CC}} = 3.3\text{V}$	—	200	—	μs
		$V_{\text{CC}} = 5\text{V}$	—	130	—	
t_{OFFD}	Output Turn-Off Delay Time	$V_{\text{CC}} = 3.3\text{V}$	—	0.5	—	μs
		$V_{\text{CC}} = 5\text{V}$	—	0.5	—	
t_{PGON}	Power Good Turn-On Time	$V_{\text{CC}} = 3.3\text{V}$	—	0.4	—	ms
		$V_{\text{CC}} = 5\text{V}$	—	0.35	—	
t_{PGOFF}	Power Good Turn-Off Time	$V_{\text{CC}} = 3.3\text{V}$	—	20	—	ns
		$V_{\text{CC}} = 5\text{V}$	—	15	—	
SR	Output Slew Rate	$V_{\text{CC}} = 3.3\text{V}$	—	17	—	kV/s
		$V_{\text{CC}} = 5\text{V}$	—	17	—	
$V_{\text{IN}} = 12\text{V}$						
t_{OND}	Output Turn-On Delay Time	$V_{\text{CC}} = 3.3\text{V}$	—	170	—	μs
		$V_{\text{CC}} = 5\text{V}$	—	110	—	
t_{OFFD}	Output Turn-Off Delay Time	$V_{\text{CC}} = 3.3\text{V}$	—	0.6	—	μs
		$V_{\text{CC}} = 5\text{V}$	—	0.55	—	
t_{PGON}	Power Good Turn-On Time	$V_{\text{CC}} = 3.3\text{V}$	—	0.6	—	ms
		$V_{\text{CC}} = 5\text{V}$	—	0.5	—	
t_{PGOFF}	Power Good Turn-Off Time	$V_{\text{CC}} = 3.3\text{V}$	—	20	—	ns
		$V_{\text{CC}} = 5\text{V}$	—	15	—	
SR	Output Slew Rate	$V_{\text{CC}} = 3.3\text{V}$	—	43	—	kV/s
		$V_{\text{CC}} = 5\text{V}$	—	43	—	

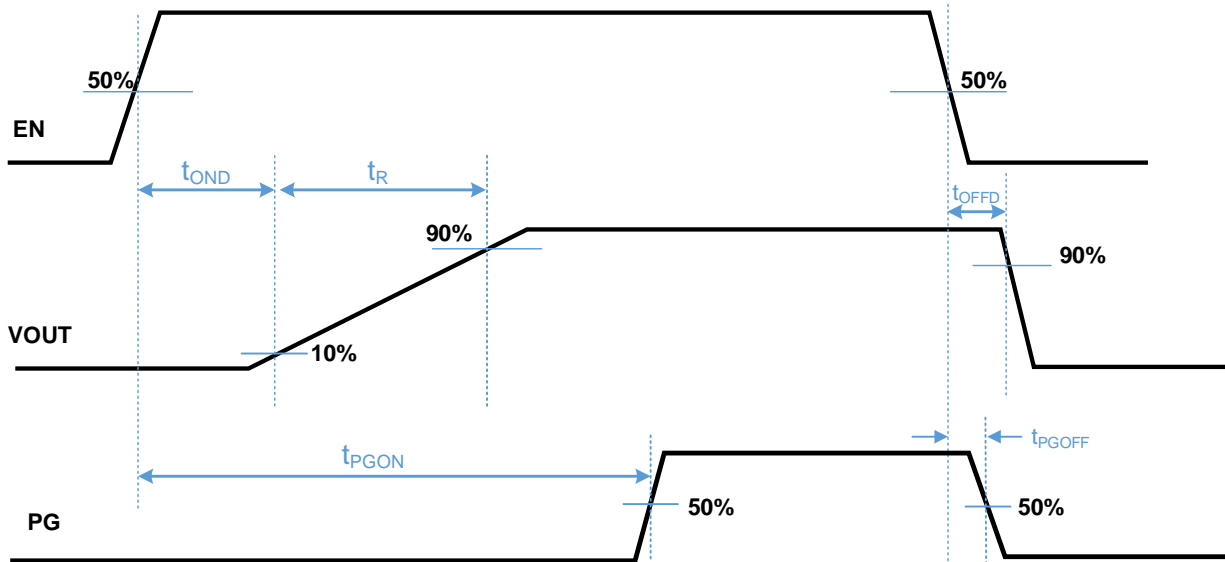
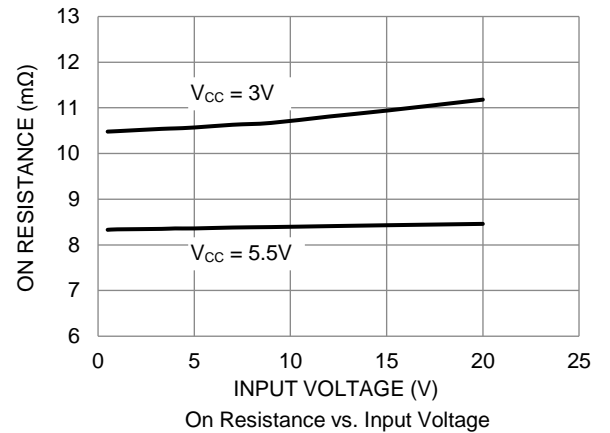
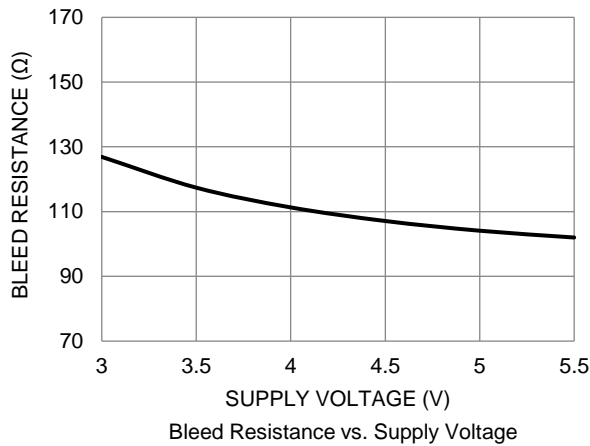
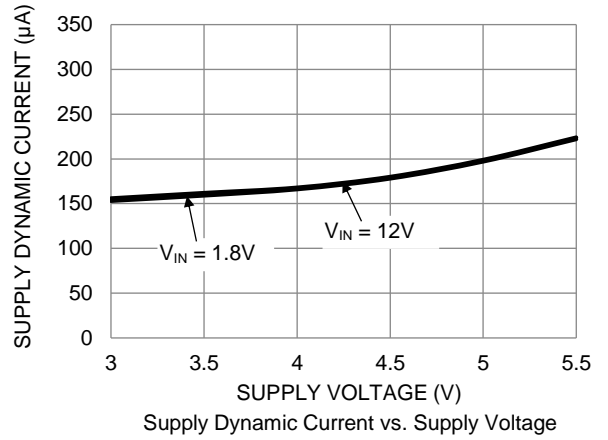
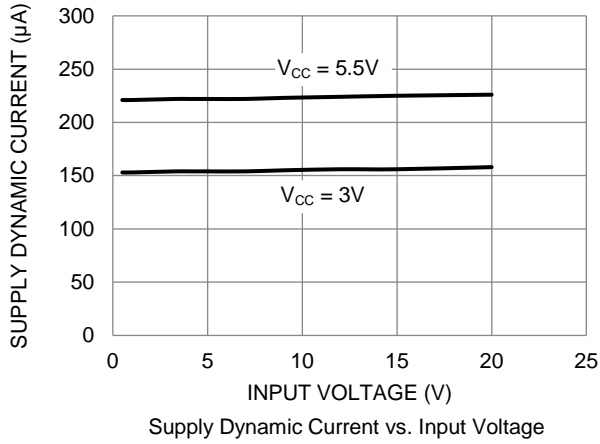

Figure 1. Timing Diagram

Performance Characteristics



Performance Characteristics

Turn On Response
 $V_{IN} = 1.8V, V_{CC} = 3.3V, V_{EN} = 0V \text{ to } 3.3V, R_L = 10\Omega$

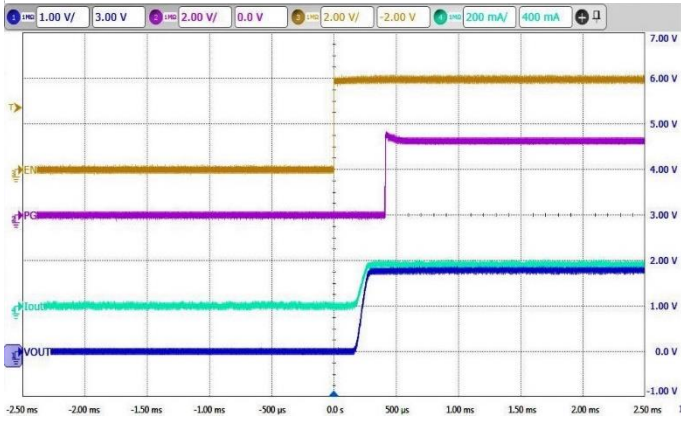

Turn Off Response
 $V_{IN} = 1.8V, V_{CC} = 3.3V, V_{EN} = 0V \text{ to } 3.3V, R_L = 10\Omega$

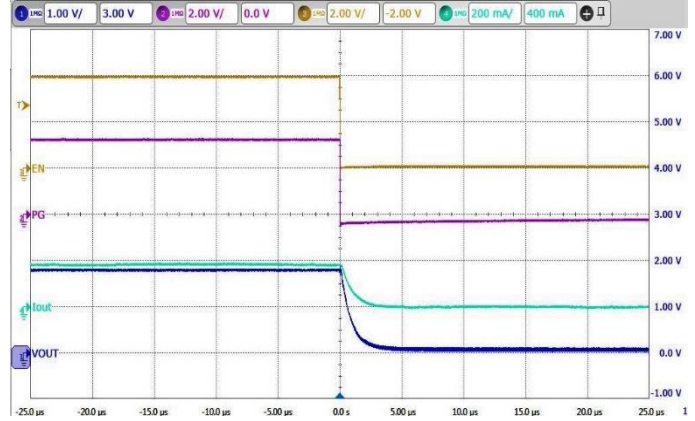

Turn On Response
 $V_{IN} = 5V, V_{CC} = 3.3V, V_{EN} = 0V \text{ to } 3.3V, R_L = 10\Omega$

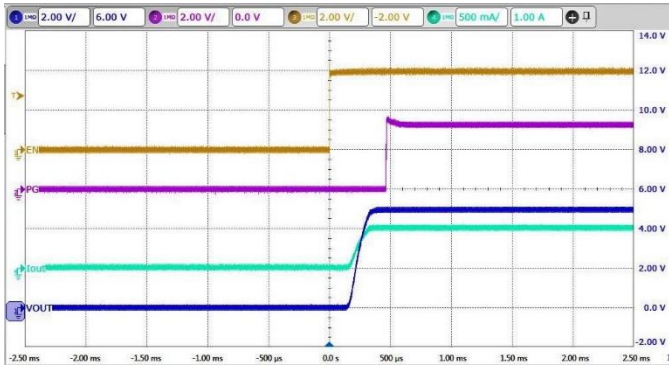

Turn Off Response
 $V_{IN} = 5V, V_{CC} = 3.3V, V_{EN} = 0V \text{ to } 3.3V, R_L = 10\Omega$

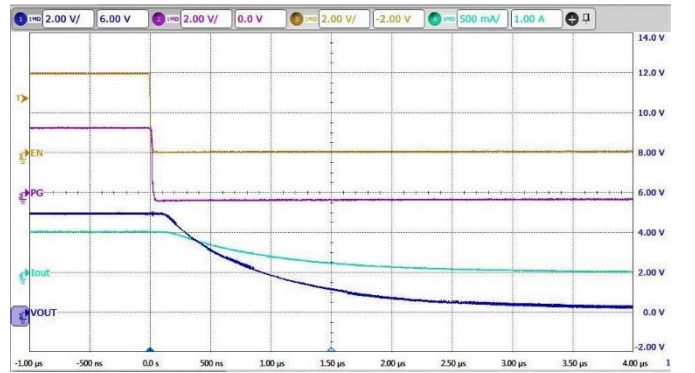

Turn On Response
 $V_{IN} = 12V, V_{CC} = 3.3V, V_{EN} = 0V \text{ to } 3.3V, R_L = 10\Omega$

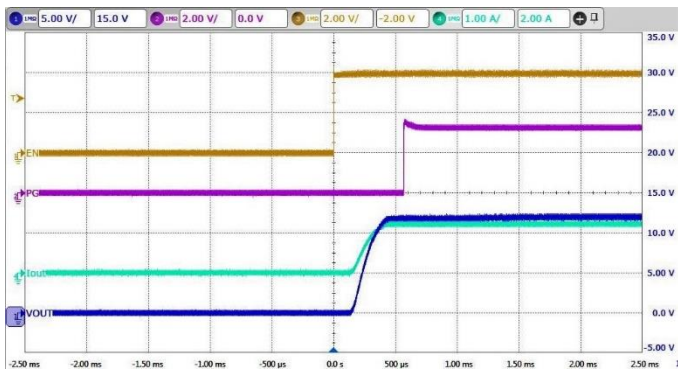

Turn Off Response
 $V_{IN} = 12V, V_{CC} = 3.3V, V_{EN} = 0V \text{ to } 3.3V, R_L = 10\Omega$

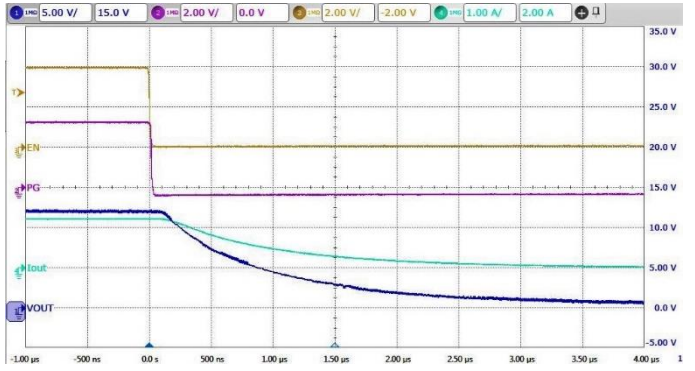

Performance Characteristics (continued)

Turn On Response
 $V_{IN} = 1.8V, V_{CC} = 5V, V_{EN} = 0V \text{ to } 5V, R_L = 10\Omega$

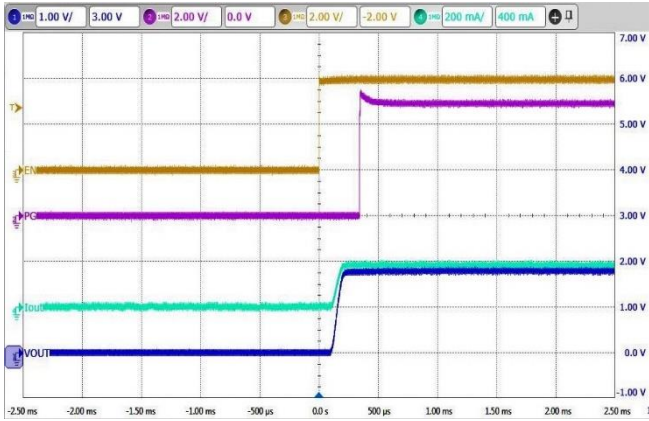

Turn Off Response
 $V_{IN} = 1.8V, V_{CC} = 5V, V_{EN} = 0V \text{ to } 5V, R_L = 10\Omega$

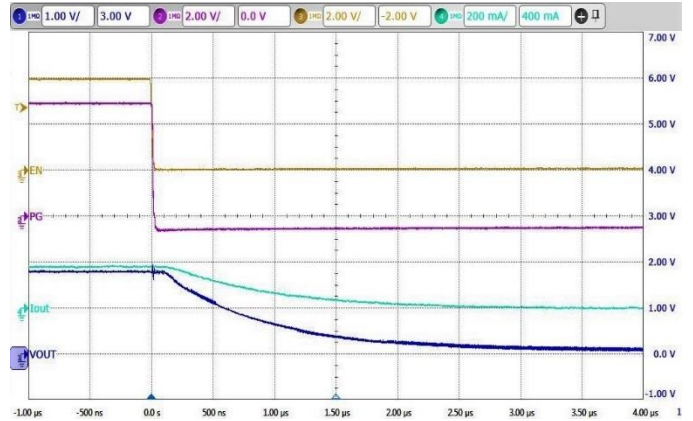

Turn On Response
 $V_{IN} = 5V, V_{CC} = 5V, V_{EN} = 0V \text{ to } 5V, R_L = 10\Omega$

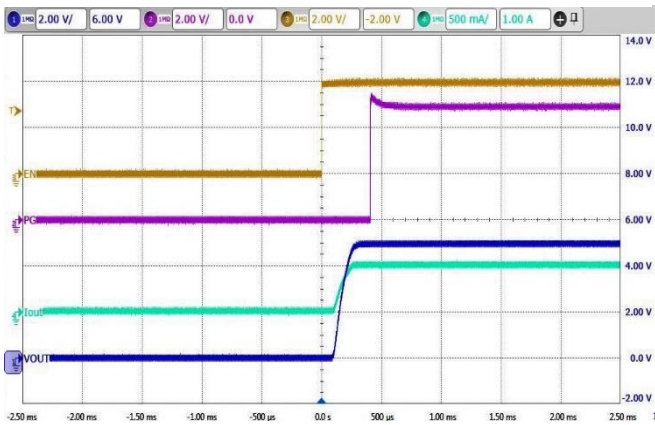

Turn Off Response
 $V_{IN} = 5V, V_{CC} = 5V, V_{EN} = 0V \text{ to } 5V, R_L = 10\Omega$

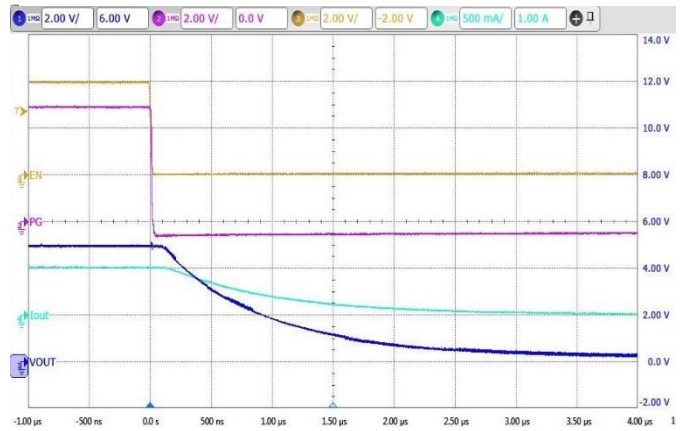

Turn On Response
 $V_{IN} = 12V, V_{CC} = 5V, V_{EN} = 0V \text{ to } 5V, R_L = 10\Omega$

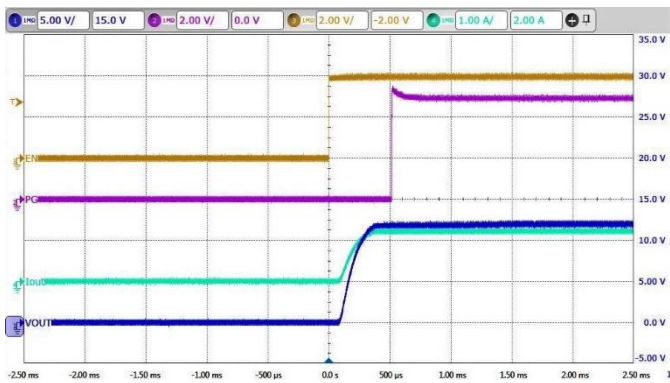

Turn Off Response
 $V_{IN} = 12V, V_{CC} = 5V, V_{EN} = 0V \text{ to } 5V, R_L = 10\Omega$

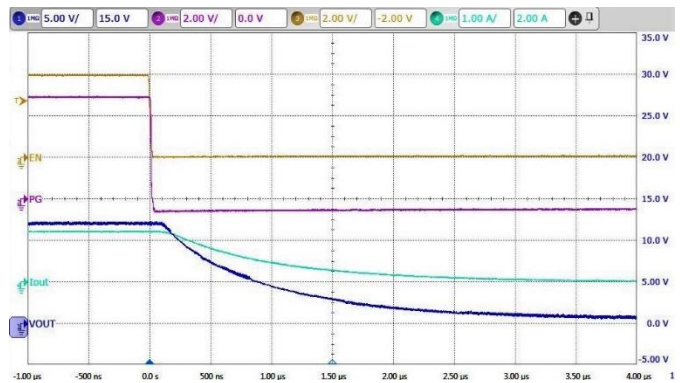

Application Information

General Description

The DML3008LFDS is a single channel load switch with a controlled adjustable turn-on and integrated PG indicator in an 8-pin V-DFN2020-8 (Type N) package. The device contains an N-channel MOSFET that can operate over an input voltage range of 0.5V to 24V and can support a maximum continuous current of 10A. The wide input voltage range and high current capability enable the device to be used across multiple designs and end equipment. The on-resistance at 11mΩ minimizes the voltage drop across the load switch and power loss from the load switch.

Integrated PG indicator notifies the system about the status of the load switch to facilitate seamless power sequencing. During shutdown, the device has very low leakage current, thereby reducing unnecessary leakages for downstream modules during standby. The DML3008LFDS also embedded 100Ω on-chip resistor on BLEED pin for quick discharge of the output when switch is disabled.

Enable Control

The DML3008LFDS device allows for enabling the MOSFET in an active-high configuration. When the VCC supply pin has an adequate voltage applied and the EN pin is at logic high level, the MOSFET will be enabled. Similarly, when the EN pin is at logic low level, the MOSFET will be disabled. An internal pull down resistor to ground on the EN pin ensures that the MOSFET will be disabled when not being driven.

Power Sequencing

The DML3008LFDS device functions with any power sequence, but the output turn-on delay performance can vary from what is specified. To archive the specified performance that we recommended power sequences is:

1. VCC → VIN → VEN
2. VIN → VCC → VEN

Load Bleed (Quick Discharge)

The DML3008LFDS device has an internal bleed discharge device, which is used to bleed the charge off of the load to ground after the MOSFET is disabled. The bleed discharge device is enabled whenever the MOSFET is disabled. The MOSFET and the bleed device are never concurrently active.

The BLEED pin must be connected to VOUT either directly or through an external resistor, REXT. REXT should not exceed 100MΩ and can be used to increase the total bleed resistance.

Care must be taken to ensure that the power dissipated across RBLEED is kept at safe level. The maximum continuous power that can be dissipates across RBLEED is 0.4W. REXT can be used to decrease the amount of power dissipated across RBLEED.

Power Good

The DML3008LFDS device has a power good output (PG) that can be used to indicate when the gate of the MOSFET is driven high and the switch is on with the on-resistance close to its final value (full load ready). The PG pin is an active-high, open-drain output that requires an external pull-up resistor, R_{PG}, greater than or equal to 1kΩ to an external voltage source, V_{TERM}, compatible with input levels of those devices connected to this pin.

The power good output can be used as the enable signal for other active-high devices in the system. This allows for guaranteed by design power sequencing and reduces the number of enable signals needed from the system controller. If the power good feature is not used in the application, the PG pin should be tied to GND.

Application Information (continued)

Thermal Shutdown

The DML3008LFDS device has equipped thermal shutdown protection for internal or externally generated excessive temperatures. This circuitry is disabled when EN is not active to reduce standby current. When an over temperature condition is detected, the MOSFET is immediately turned off and the load bleed is active.

The part comes out of thermal shutdown when the junction temperature decreases to a safe operating temperature as dictated by the thermal hysteresis. Upon exiting a thermal shutdown state, and if EN remains active, the MOSFET will be turned on in a controlled fashion with the normal output turn-on delay and slew rate.

PCB Layout Consideration

1. Place the input/output capacitors C_{VIN} and C_{VOUT} as close as possible to the V_{IN} and V_{OUT} pins.
2. The power traces which are V_{IN} trace, V_{OUT} trace and GND trace should be short, wide and directly for minimize parasitic inductance.
3. Place feedback resistance R_{BLEED} as close as possible to BLEED pin.
4. Place C_{VCC} capacitor near the device pin.
5. Connect the signal ground to the GND pin, and keep a single connection from GND pin to the power ground behind the input or output capacitors.
6. For better power dissipation, via holes are recommended to connect the exposed pad's landing area to a large copper polygon on the other side of the printed circuit board. The copper polygons and exposed pad shall connect to V_{IN} pin on the printed circuit board.

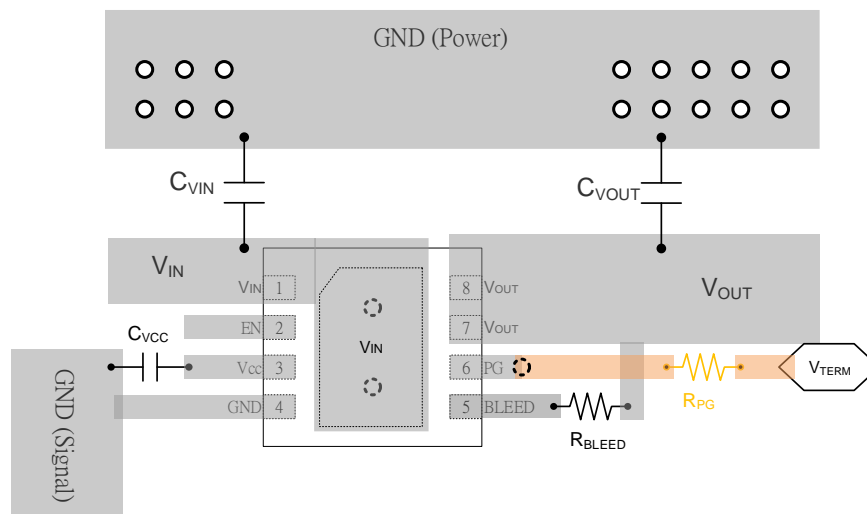

Package Outline Dimensions

Please see <http://www.diodes.com/package-outlines.html> for the latest version.

V-DFN2020-8 (Type N)

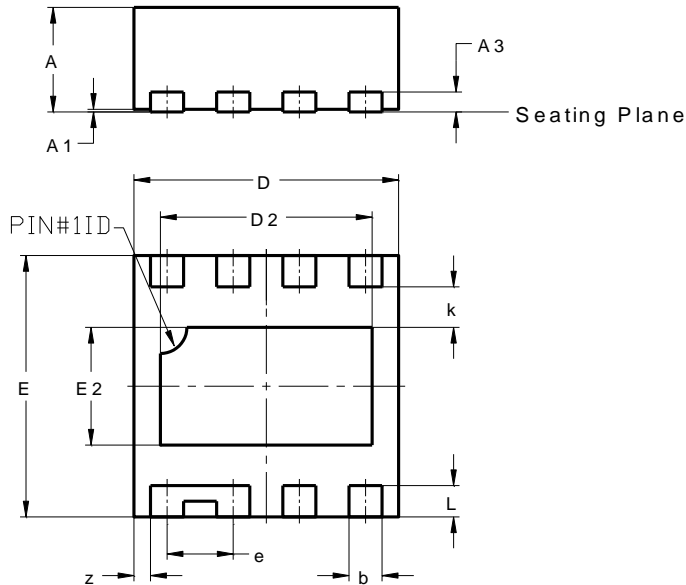

V-DFN2020-8 (Type N)			
Dim	Min	Max	Typ
A	0.75	0.85	0.80
A1	0.00	0.05	0.02
A3	--	--	0.152
b	0.20	0.30	0.25
D	1.95	2.05	2.00
D2	1.50	1.70	1.60
E	1.95	2.05	2.00
E2	0.80	1.00	0.90
e	--	--	0.50
k	--	--	0.31
L	0.19	0.29	0.24
z	--	--	0.125
All Dimensions in mm			

Suggested Pad Layout

Please see <http://www.diodes.com/package-outlines.html> for the latest version.

V-DFN2020-8 (Type N)

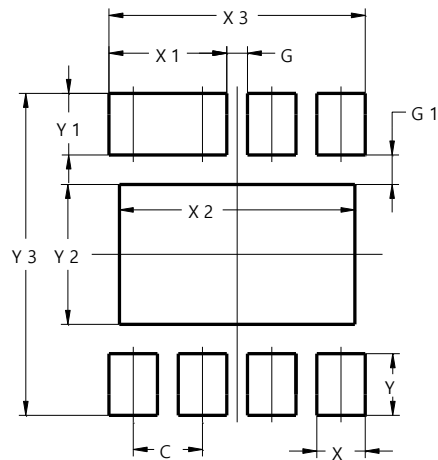

Dimensions	Value (in mm)
C	0.500
G	0.150
G1	0.210
X	0.350
X1	0.850
X2	1.700
X3	1.850
Y	0.440
Y1	0.440
Y2	1.000
Y3	2.300

IMPORTANT NOTICE



1. DIODES INCORPORATED (Diodes) AND ITS SUBSIDIARIES MAKE NO WARRANTY OF ANY KIND, EXPRESS OR IMPLIED, WITH REGARDS TO ANY INFORMATION CONTAINED IN THIS DOCUMENT, INCLUDING, BUT NOT LIMITED TO, THE IMPLIED WARRANTIES OF MERCHANTABILITY, FITNESS FOR A PARTICULAR PURPOSE OR NON-INFRINGEMENT OF THIRD PARTY INTELLECTUAL PROPERTY RIGHTS (AND THEIR EQUIVALENTS UNDER THE LAWS OF ANY JURISDICTION).
2. The Information contained herein is for informational purpose only and is provided only to illustrate the operation of Diodes' products described herein and application examples. Diodes does not assume any liability arising out of the application or use of this document or any product described herein. This document is intended for skilled and technically trained engineering customers and users who design with Diodes' products. Diodes' products may be used to facilitate safety-related applications; however, in all instances customers and users are responsible for (a) selecting the appropriate Diodes products for their applications, (b) evaluating the suitability of Diodes' products for their intended applications, (c) ensuring their applications, which incorporate Diodes' products, comply the applicable legal and regulatory requirements as well as safety and functional-safety related standards, and (d) ensuring they design with appropriate safeguards (including testing, validation, quality control techniques, redundancy, malfunction prevention, and appropriate treatment for aging degradation) to minimize the risks associated with their applications.
3. Diodes assumes no liability for any application-related information, support, assistance or feedback that may be provided by Diodes from time to time. Any customer or user of this document or products described herein will assume all risks and liabilities associated with such use, and will hold Diodes and all companies whose products are represented herein or on Diodes' websites, harmless against all damages and liabilities.
4. Products described herein may be covered by one or more United States, international or foreign patents and pending patent applications. Product names and markings noted herein may also be covered by one or more United States, international or foreign trademarks and trademark applications. Diodes does not convey any license under any of its intellectual property rights or the rights of any third parties (including third parties whose products and services may be described in this document or on Diodes' website) under this document.
5. Diodes' products are provided subject to Diodes' Standard Terms and Conditions of Sale (<https://www.diodes.com/about/company/terms-and-conditions/terms-and-conditions-of-sales/>) or other applicable terms. This document does not alter or expand the applicable warranties provided by Diodes. Diodes does not warrant or accept any liability whatsoever in respect of any products purchased through unauthorized sales channel.
6. Diodes' products and technology may not be used for or incorporated into any products or systems whose manufacture, use or sale is prohibited under any applicable laws and regulations. Should customers or users use Diodes' products in contravention of any applicable laws or regulations, or for any unintended or unauthorized application, customers and users will (a) be solely responsible for any damages, losses or penalties arising in connection therewith or as a result thereof, and (b) indemnify and hold Diodes and its representatives and agents harmless against any and all claims, damages, expenses, and attorney fees arising out of, directly or indirectly, any claim relating to any noncompliance with the applicable laws and regulations, as well as any unintended or unauthorized application.
7. While efforts have been made to ensure the information contained in this document is accurate, complete and current, it may contain technical inaccuracies, omissions and typographical errors. Diodes does not warrant that information contained in this document is error-free and Diodes is under no obligation to update or otherwise correct this information. Notwithstanding the foregoing, Diodes reserves the right to make modifications, enhancements, improvements, corrections or other changes without further notice to this document and any product described herein. This document is written in English but may be translated into multiple languages for reference. Only the English version of this document is the final and determinative format released by Diodes.
8. Any unauthorized copying, modification, distribution, transmission, display or other use of this document (or any portion hereof) is prohibited. Diodes assumes no responsibility for any losses incurred by the customers or users or any third parties arising from any such unauthorized use.
9. This Notice may be periodically updated with the most recent version available at <https://www.diodes.com/about/company/terms-and-conditions/important-notice>

The Diodes logo is a registered trademark of Diodes Incorporated in the United States and other countries.
All other trademarks are the property of their respective owners.
© 2024 Diodes Incorporated. All Rights Reserved.

www.diodes.com

Looking for pricing, stock, or lifecycle information?

Click below to explore more details on WIN SOURCE:

-  [View DML3008LFDS-7 on WIN SOURCE](#)
-  [Diodes Incorporated Information](#)

Optimize Your Supply Chain with WIN SOURCE Solutions

-  Global Sourcing Solution
-  Obsolete Management
-  Cost Control Management
-  Shortage Management
-  Alternative Solution
-  Excess Inventory Management