

WIN**SOURCE**
ELECTRONICS

THE DATASHEET OF
1376477-4



1376477-4 ✓ ACTIVE

AMP Signal Double Lock

TE Internal #: 1376477-4

Housing, Plug, Wire-to-Board, 4 Position, 2.5 mm [.098 in]

Centerline, Crimp, 1 Row, Natural, Mating Retention, AMP Signal

Double Lock

[View on TE.com >](#)



Connectors > PCB Connectors > Wire-to-Board Connectors > Wire-to-Board Connector Assemblies & Housings

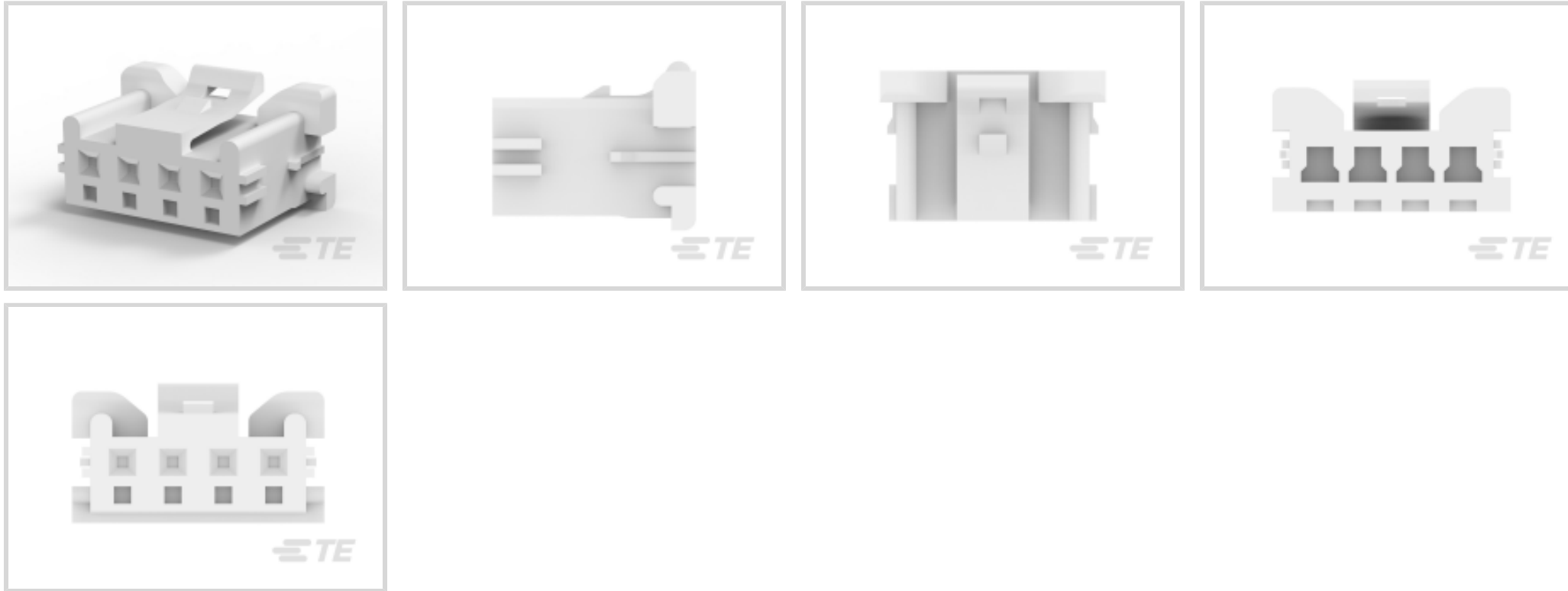

Connector Product Type: **Housing**

Connector & Housing Type: **Plug**

Connector System: **Wire-to-Board**

Number of Positions: **4**

Centerline (Pitch): **2.5 mm [.098 in]**

Features

Product Type Features

Connector Product Type	Housing
Connector & Housing Type	Plug
Connector System	Wire-to-Board
Sealable	No
Connector & Contact Terminates To	Printed Circuit Board

Configuration Features

Number of Positions	4
Number of Rows	1

Electrical Characteristics

Operating Voltage	50 VAC
-------------------	--------

Body Features

Primary Product Color	Natural
-----------------------	---------

Contact Features

--	--



Contact Layout	Inline
Contact Type	Pin
Contact Base Material	Phosphor Bronze
Contact Current Rating (Max)	2.5 A

Termination Features

Termination Method to Wire & Cable	Crimp
------------------------------------	-------

Mechanical Attachment

Strain Relief	Without
Panel Mount Feature	Without
PCB Mount Retention	Without
Mating Retention Type	Latch
Mating Retention	With
Connector Mounting Type	Cable Mount (Free-Hanging)

Housing Features

Housing Material	Nylon 66 GF
Centerline (Pitch)	2.5 mm [.098 in]

Dimensions

Connector Length	12.5 mm [.492 in]
Connector Height	6.5 mm [.256 in]
Wire Size	.12 – .38 mm ²

Usage Conditions

Operating Temperature Range	-30 – 105 °C [-22 – 221 °F]
-----------------------------	-----------------------------

Operation/Application

Circuit Application	Power & Signal
---------------------	----------------

Industry Standards

UL Flammability Rating	UL 94V-0
------------------------	----------

Packaging Features

Packaging Quantity	400
Packaging Method	Bag & Box

Product Compliance

[For compliance documentation, visit the product page on TE.com>](#)



EU RoHS Directive 2011/65/EU	Compliant
EU ELV Directive 2000/53/EC	Compliant
China RoHS 2 Directive MIIT Order No 32, 2016	No Restricted Materials Above Threshold
EU REACH Regulation (EC) No. 1907/2006	Current ECHA Candidate List: JUNE 2024 (241) Candidate List Declared Against: JUNE 2024 (241) Does not contain REACH SVHC
Halogen Content	Not Low Halogen - contains Br or Cl > 900 ppm.
Solder Process Capability	Not applicable for solder process capability

Product Compliance Disclaimer

This information is provided based on reasonable inquiry of our suppliers and represents our current actual knowledge based on the information they provided. This information is subject to change. The part numbers that TE has identified as EU RoHS compliant have a maximum concentration of 0.1% by weight in homogenous materials for lead, hexavalent chromium, mercury, PBB, PBDE, DBP, BBP, DEHP, DIBP, and 0.01% for cadmium, or qualify for an exemption to these limits as defined in the Annexes of Directive 2011/65/EU (RoHS2). Finished electrical and electronic equipment products will be CE marked as required by Directive 2011/65/EU. Components may not be CE marked. Additionally, the part numbers that TE has identified as EU ELV compliant have a maximum concentration of 0.1% by weight in homogenous materials for lead, hexavalent chromium, and mercury, and 0.01% for cadmium, or qualify for an exemption to these limits as defined in the Annexes of Directive 2000/53/EC (ELV). Regarding the REACH Regulation, the information TE provides on SVHC in articles for this part number is based on the latest European Chemicals Agency (ECHA) 'Guidance on requirements for substances in articles' posted at this URL: <https://echa.europa.eu/guidance-documents/guidance-on-reach>

Compatible Parts



TE Part # 1717567-4
DBL LOCK PLATE FOR SMC PLUG 4P



TE Part # 5-1376492-4
2.5 SMC HDR 4POS WHITE TAPE



TE Part # 1473585-1
I/O THROUGH CONNECTOR ASS'Y 4P



TE Part # 7-1376492-4
2.5 SMC HDR 4POS BLUE TAPE



TE Part # 1743492-1
BLOWER MOTOR 3P PLUG HSG



TE Part # 2-1376477-4
2.5MM PITCH SIGNAL MATE CONN



TE Part # 2321467-1
I/O THROUGH CONNECTOR ASS'Y 4P



TE Part # 2371020-4
DBL LOCK PLATE FOR SMC PLUG 4P



Also in the Series | AMP Signal Double Lock

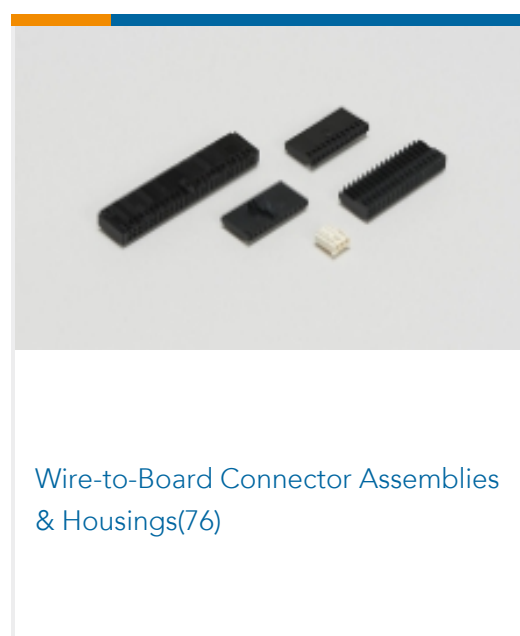
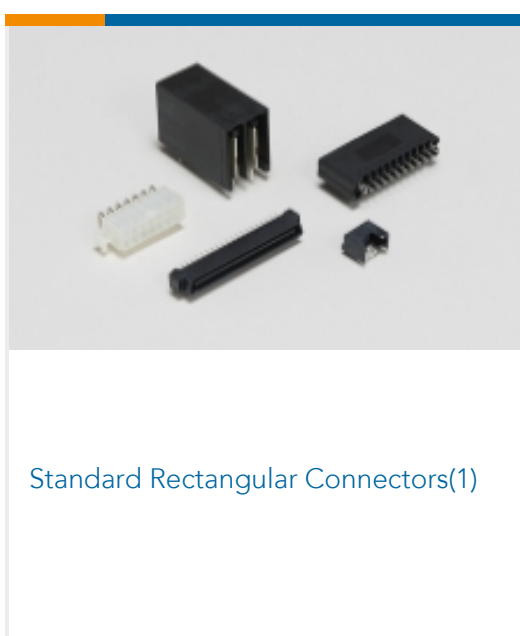
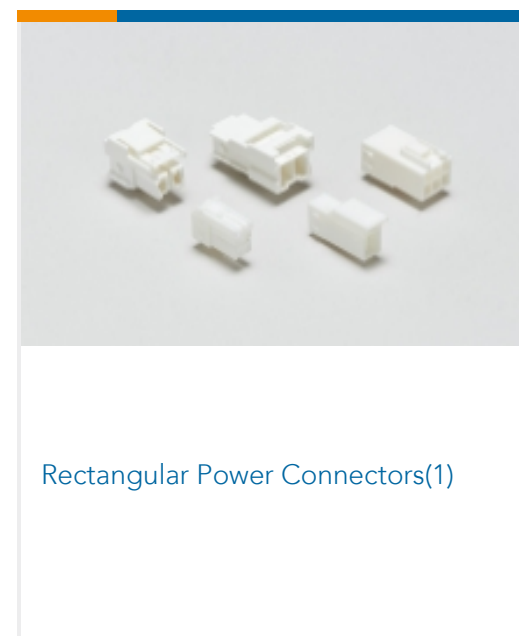
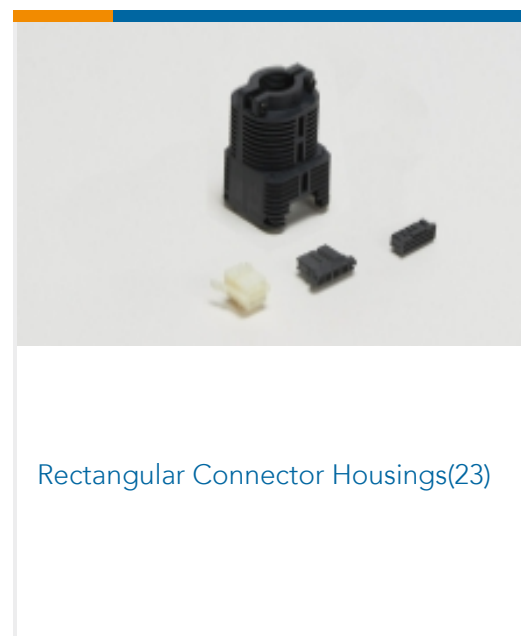
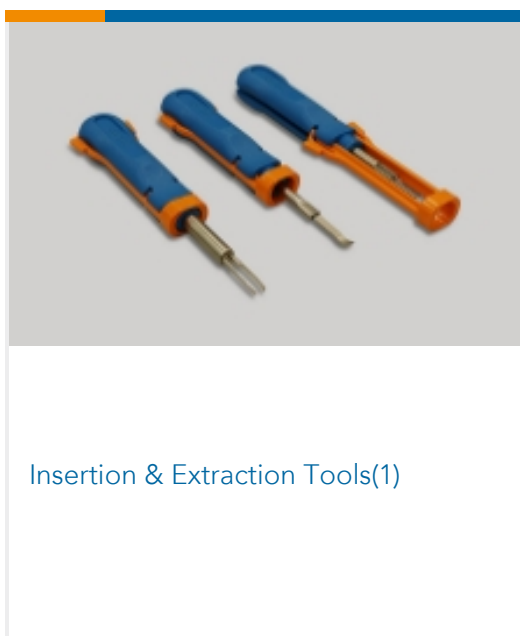
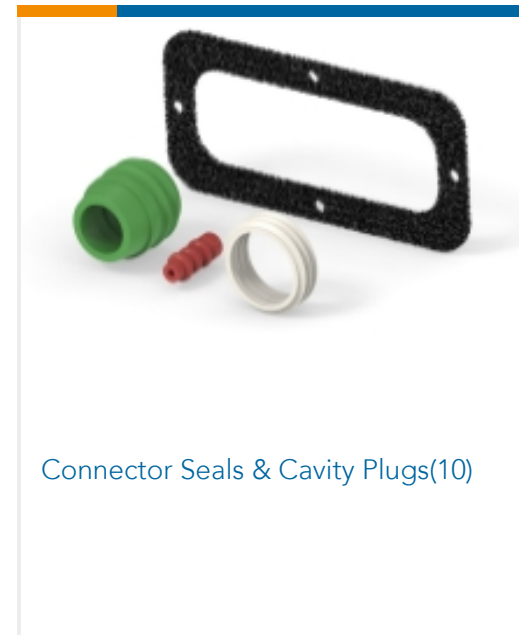
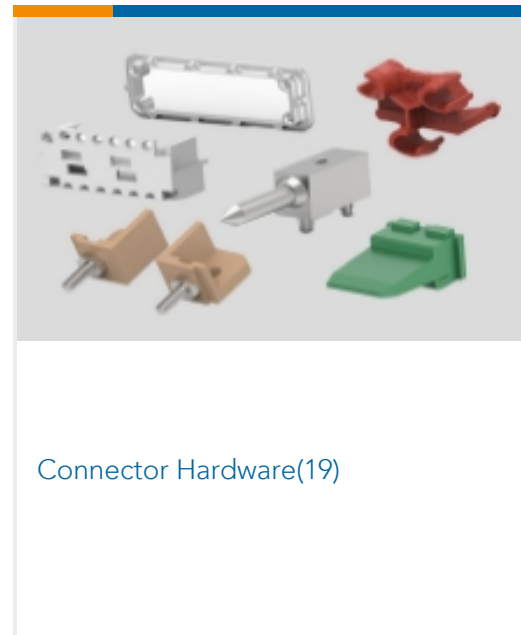
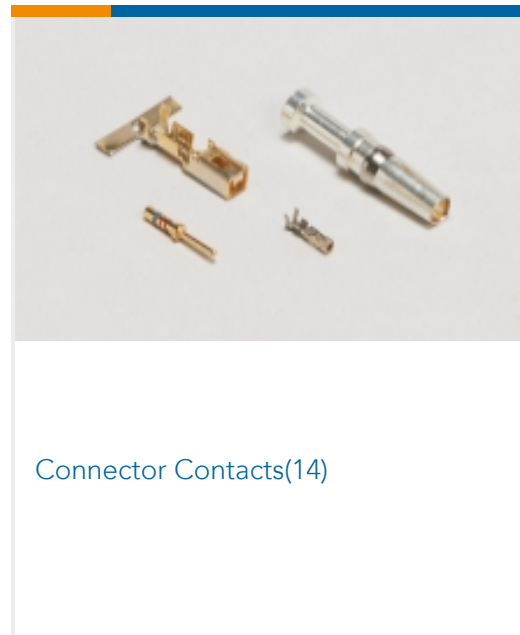

Customers Also Bought



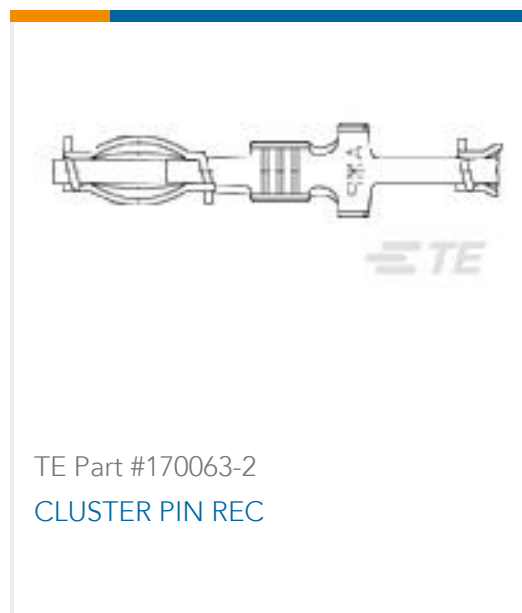
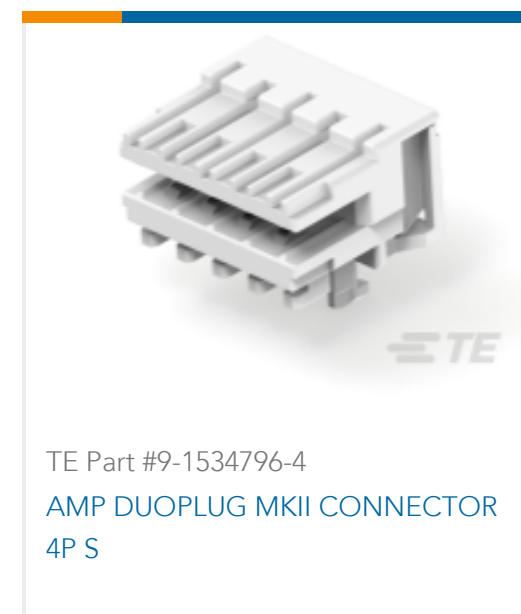
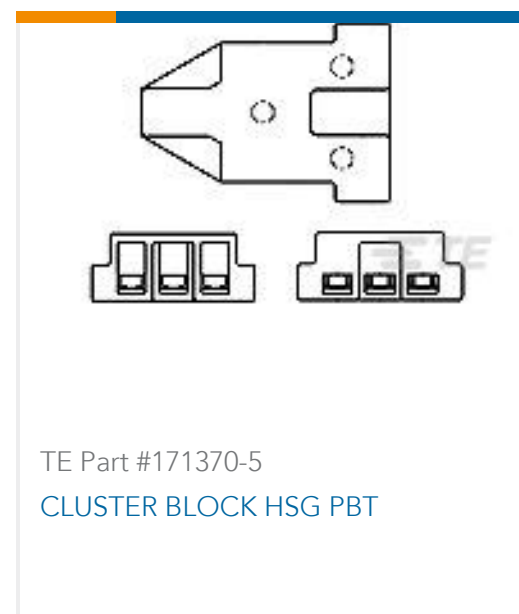

Documents

Product Drawings

2.5MM PITCH SIGNAL MATE CONN

English

CAD Files

Customer View Model

[ENG_CVM_CVM_1376477-4_E.2d_dxf.zip](#)

English

3D PDF

3D

Customer View Model

[ENG_CVM_CVM_1376477-4_E.3d_igs.zip](#)

English

Customer View Model

[ENG_CVM_CVM_1376477-4_E.3d_stp.zip](#)

English

By downloading the CAD file I accept and agree to the [Terms and Conditions](#) of use.

Product Specifications

Application Specification

English

Looking for pricing, stock, or lifecycle information?

Click below to explore more details on WIN SOURCE:

[View 1376477-4 on WIN SOURCE](#)

[TE Connectivity Information](#)

Optimize Your Supply Chain with WIN SOURCE Solutions

- ✓ Global Sourcing Solution
- ✓ Obsolete Management
- ✓ Cost Control Management
- ✓ Shortage Management
- ✓ Alternative Solution
- ✓ Excess Inventory Management