



THE DATASHEET OF
AL5890-20P1-13



Description

The AL5890 is a 400V constant current LED driver and it provides a cost-effective two pin solution. It has good temperature stability and the current accuracy of $< \pm 2.0\text{mA}$ (typ.) regulated over a wide voltage and temperature range. The AL5890 comes in various or pre-fixed output current options removing the need for external current setting resistors and creating a simple driver solution for the series of LEDs. The AL5890 supports both the high-side and low-side driving of LED chains.

The AL5890 turns on when the voltage between IN and OUT is greater than 7V. Long LED chain application up to 400V operating voltage subject to package thermal limitation.

The AL5890 is available in thermally robust PowerDI[®]123 (Type B), SOT89 and TO252 (Standard) packages.

Features

- DC up to 400V Operating Voltage With Long LED Chains Subject to Package Thermal Constraint
- LED Current Tolerance Over Wide Temperature Range $< \pm 2.0\text{mA}$ (typ.)
- Thermal Foldback Protection
- 10mA, 15mA, 20mA, 30mA, and 40mA pre-fixed Constant Output Current Options
- PowerDI123 (Type B), SOT89 and TO252 (Standard) Thermally Enhanced Packages
- **Totally Lead-Free & Fully RoHS Compliant (Notes 1 & 2)**
- **Halogen and Antimony Free. "Green" Device (Note 3)**

Pin Assignments (Top View)

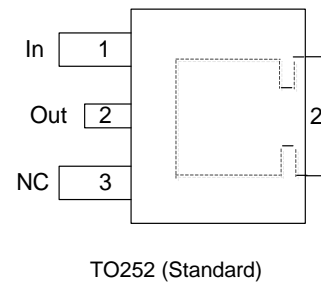
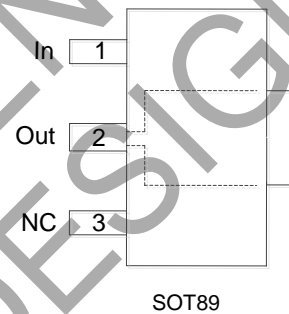
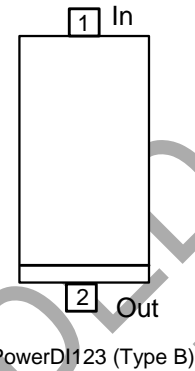

Applications

- Commercial LED Lighting Fixtures
- Emergency Lighting
- Signage, Downlights, Decorative and Architectural Lighting

Notes:

1. No purposely added lead. Fully EU Directive 2002/95/EC (RoHS), 2011/65/EU (RoHS 2) & 2015/863/EU (RoHS 3) compliant.
2. See <https://www.diodes.com/quality/lead-free/> for more information about Diodes Incorporated's definitions of Halogen- and Antimony-free, "Green" and Lead-free.
3. Halogen- and Antimony-free "Green" products are defined as those which contain $< 900\text{ppm}$ bromine, $< 900\text{ppm}$ chlorine ($< 1500\text{ppm}$ total Br + Cl) and $< 1000\text{ppm}$ antimony compounds.

Typical Applications Circuit

(AC Configuration)

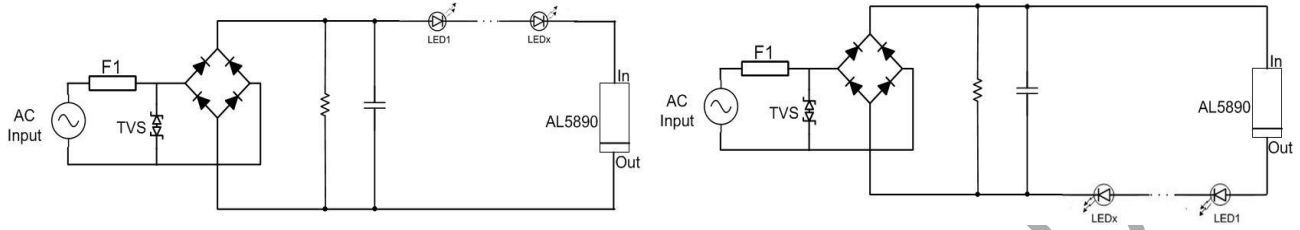

(DC Configuration)

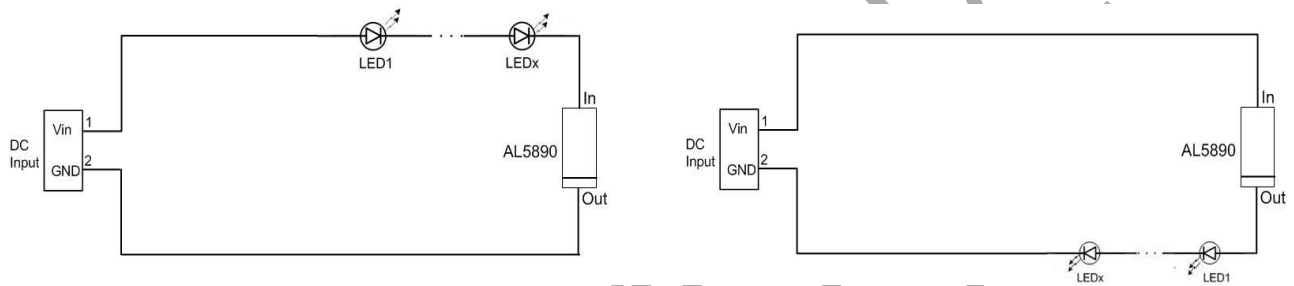

Pin Descriptions

Pin Name	Pin Number			Function
	PowerDI123 (Type B)	SOT89	TO252 (Standard)	
In	1	1	1	LED Current Input Terminal (Note 4)
Out	2	2	2	LED Current Output Terminal (Note 4)
NC	-	3	3	Not Connected
Exposed Pad	-	2	2	-

Note: 4. Stresses greater than the Absolute Maximum Ratings specified above may cause permanent damage to the device. These are stress ratings only, and functional operation of the device at these or any other conditions exceeding those indicated in this specification is not implied. Device reliability may be affected by exposure to absolute maximum rating conditions for extended periods of time. Semiconductor devices are ESD sensitive and may be damaged by exposure to ESD events. Suitable ESD precautions should be taken when handling and transporting these devices.

Functional Block Diagram

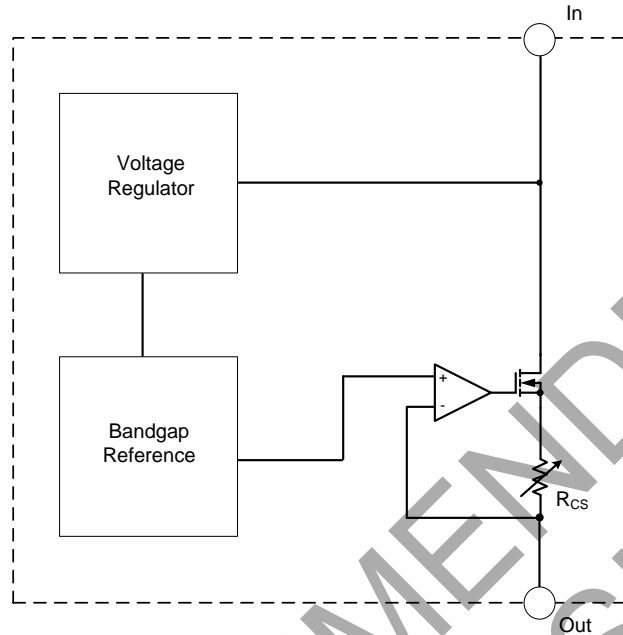

Absolute Maximum Ratings (Note 4)

Symbol	Parameters	Ratings	Unit
V_{IN_OUT}	IN Voltage Relative to OUT Pin	-0.3 to +425	V
I_{IN_OUT}	LED Current Flows from IN to OUT Pin	50	mA
T_J	Operating Junction Temperature	-40 to +150	°C
T_{ST}	Storage Temperature	-55 to +150	°C

ESD Ratings

Symbol	Parameter	Rating	Unit
V_{ESD}	Human-Body Model (HBM)	2000	V
	Charged-Device Model (CDM)	1000	

Recommended Operating Conditions

Symbol	Parameter	Min	Max	Unit
V_{IN_OUT}	IN Voltage Relative to OUT Pin	7	400	V
I_{IN_OUT}	Current Flows from IN to OUT Pin	10	40	mA
T_A	Operating Ambient Temperature Range	-40	+105	°C
T_J	Operating Junction Temperature	-40	+125	°C

Thermal Information (Note 5)

Package	θ_{JC} Thermal Resistance Junction-to-Case	θ_{JA} Thermal Resistance Junction-to-Ambient	P_{DIS} $T_A = +25^\circ\text{C}, T_J = +125^\circ\text{C}$
PowerDI123 (Type B)	15.33°C/W	75.84°C/W (Note 6)	1.33W
SOT89	6.34°C/W	27.85°C/W (Note 6)	3.61W
TO252 (Standard)	5.10°C/W	26.12°C/W (Note 6)	3.85W

- Note:
- When mounted on 50.8mm x 50.8mm GETEK PCB with 25.4mm x 25.4mm 2oz copper pads. For better thermal performance, larger copper pad for heat-sink is needed.
 - Stresses greater than the Absolute Maximum Ratings specified above may cause permanent damage to the device. These are stress ratings only, and functional operation of the device at these or any other conditions exceeding those indicated in this specification is not implied. Device reliability may be affected by exposure to absolute maximum rating conditions for extended periods of time. Semiconductor devices are ESD sensitive and may be damaged by exposure to ESD events. Suitable ESD precautions should be taken when handling and transporting these devices.

Electrical Characteristics ($V_{IN_OUT} = 10V, T_A = +25^\circ\text{C}, T_J < +125^\circ\text{C}$, Unless Otherwise Noted.)

Symbol	Parameter	Test Condition	Min	Typ	Max	Unit
V_{IN_OUT}	Supply Voltage	(Note 7)	7	-	400	V
V_{MIN}	Minimum Power Up Voltage	Increase V_{IN_OUT} (Note 8)	2.5	5	7	V
I_{IN_OUT}	LED Current (Note 9)	AL5890-10	9.0	10	11.0	mA
		AL5890-15	13.5	15	16.5	
		AL5890-20	18.5	20	21.5	
		AL5890-30	28.0	30	32.0	
		AL5890-40	38.0	40	42.0	
I_{LINE}	Line Regulation	$V_{IN_OUT} = 20V$ to 60V, 20mA current option	-	1.5	-	%
T_{coeff}	Temperature Coefficient	(Note 10)	-	3	-	%
t_{ON}	Turn On Delay Time	-	-	6	-	μs
t_{OFF}	Turn Off Delay Time	-	-	0.3	-	μs
t_R	Rising Time	-	-	6	-	μs
t_F	Falling Time	-	-	0.1	-	μs
T_{FOLD}	Thermal Foldback Junction Temperature	Junction Temperature	-	+130	-	$^\circ\text{C}$

- Note:
- DC power supply slew rate set at 10V/msec to avoid any excessive inrush current.
 - Apply the power supply voltage linearly to the chip until the device starts to turn on (output LED current reaches 5% of the desired current options). The minimum power up voltage may vary with different current options.
 - Based on ATE trimmed accuracy at +25°C.
 - This parameter only guaranteed by design, not tested in production.

Typical Performance Characteristics (PowerDI123 (Type B), 20mA Device) – 1"x1" PCB with 2oz. Copper, no Heatsink

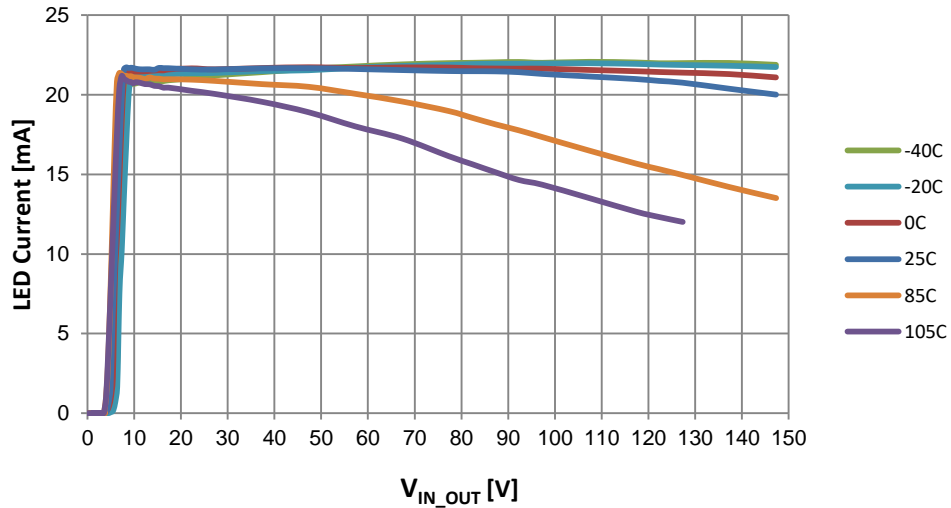

Figure 1. LED Current (-40°C to 105°C) vs. V_{IN_OUT}

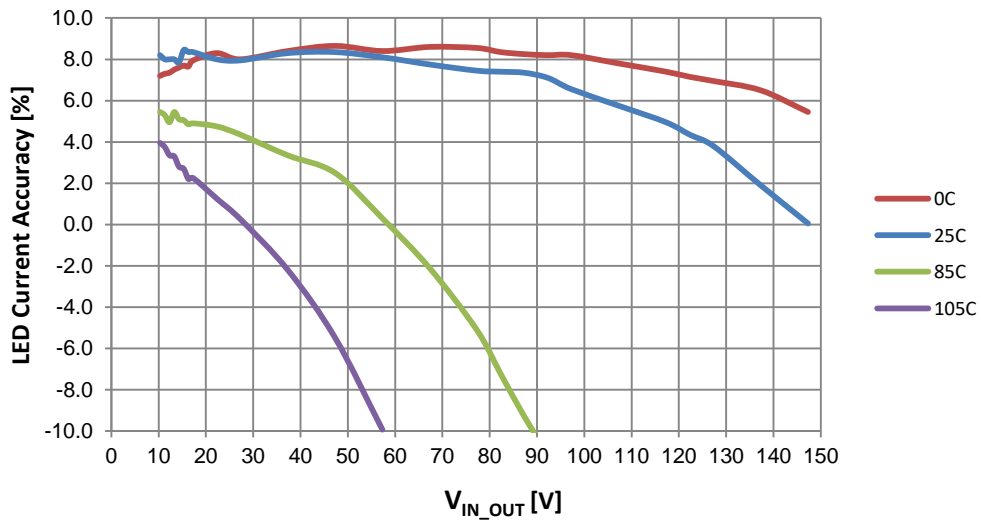

Figure 2. LED Current Accuracy (0°C to 105°C) vs. V_{IN_OUT}

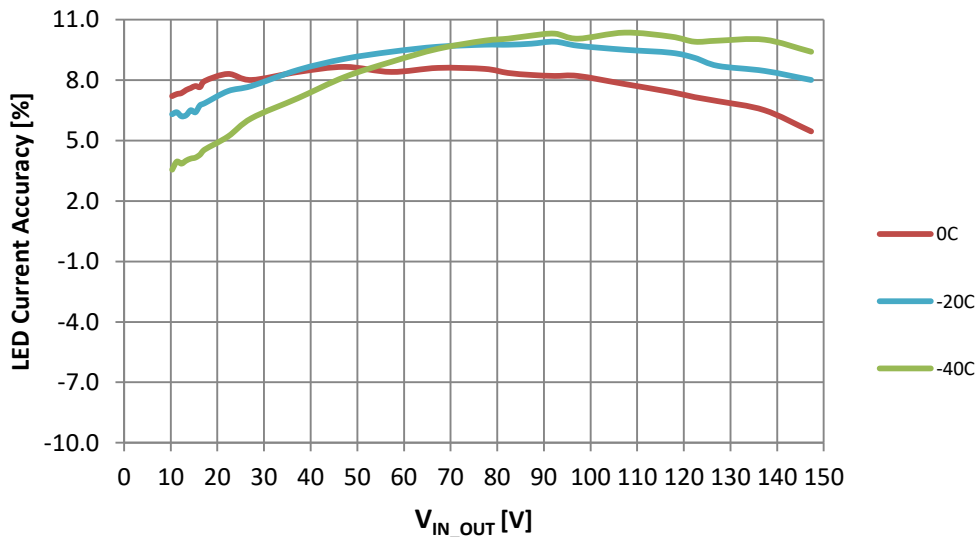

Figure 3. LED Current Accuracy (-40°C to 0°C) vs. V_{IN_OUT}

Typical Performance Characteristics (Cont.) (PowerDI123 (Type B), 20mA Device) – 1"x1" PCB with 2oz. Copper, no Heatsink

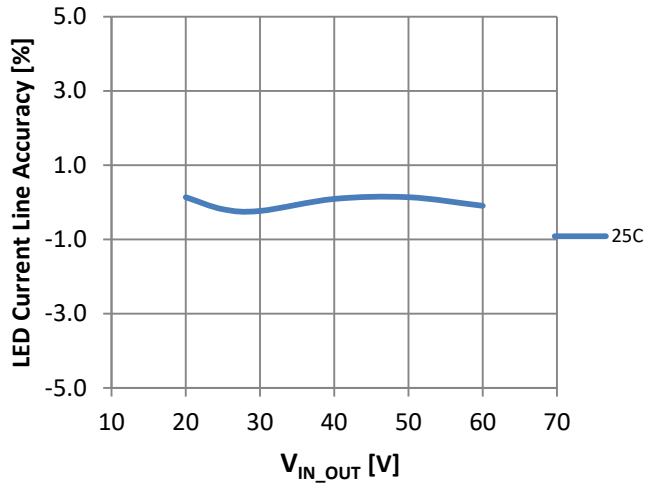

Figure 4. LED Line Regulation @ 25°C vs. V_{IN_OUT} (20V to 60V)

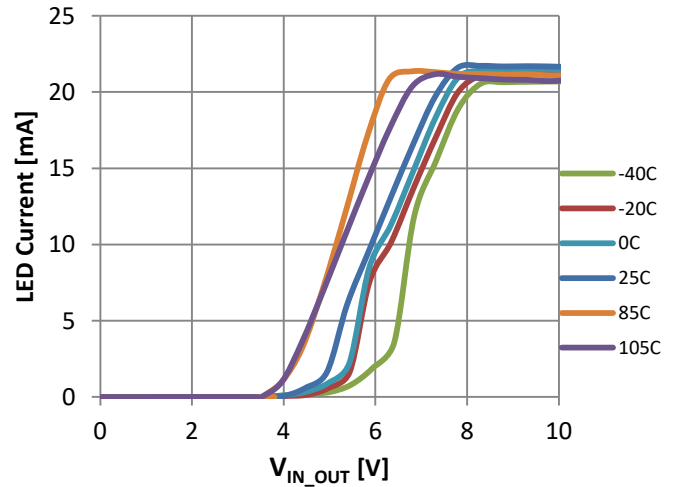

Figure 5. Startup Minimum Operating Voltage

Typical Performance Characteristics (40mA SOT89-3 Options) – 1"x1" PCB with 2oz. Copper, no Heatsink

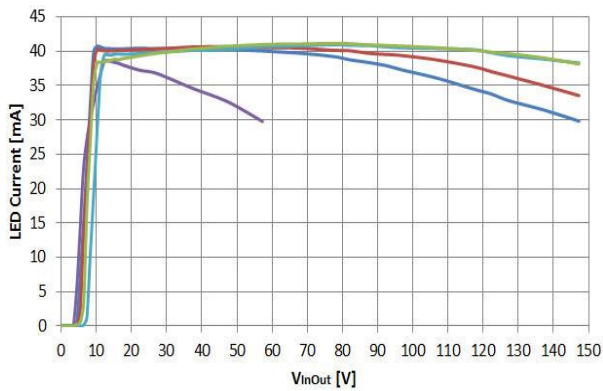

Figure 6. LED Current (-40°C to +105°C) vs. V_{IN_OUT}

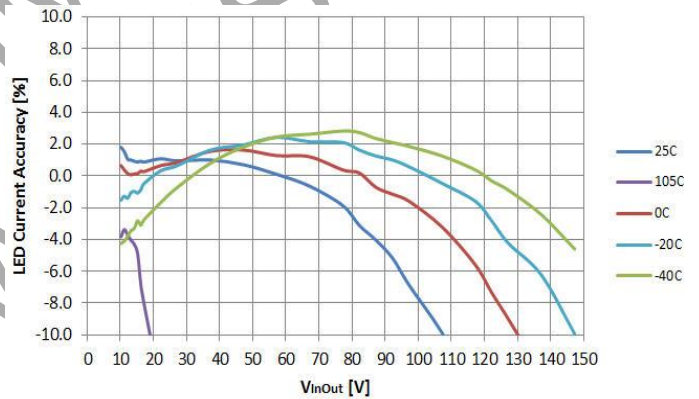

Figure 7. LED Current Accuracy (-40°C to +105°C) vs. V_{IN_OUT}

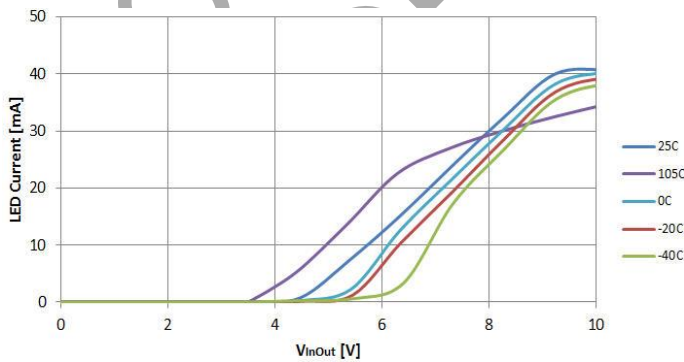

Figure 8. Device Turning On Threshold Across Temperature

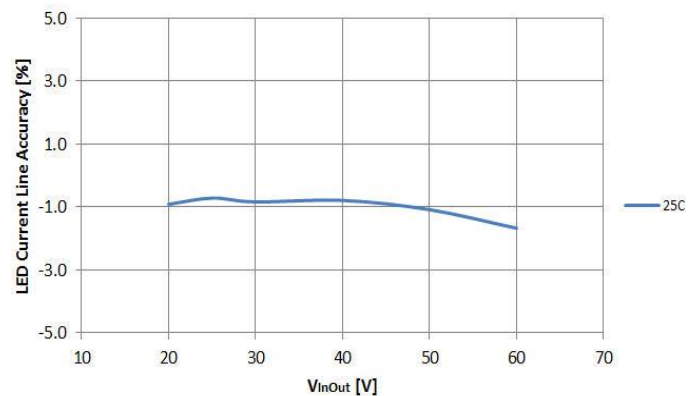

Figure 9. LED Line Regulation (% @ +25°C) vs. V_{IN_OUT} (20V to 60V)

Typical Performance Characteristics (40mA TO252 (Standard)-3 Options) – 1"x1" PCB with 2oz. Copper, no Heatsink

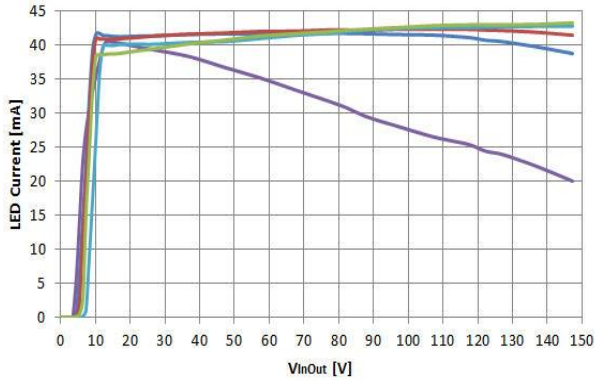

Figure 10. LED Current (-40°C to +105°C) vs. V_{IN_OUT}

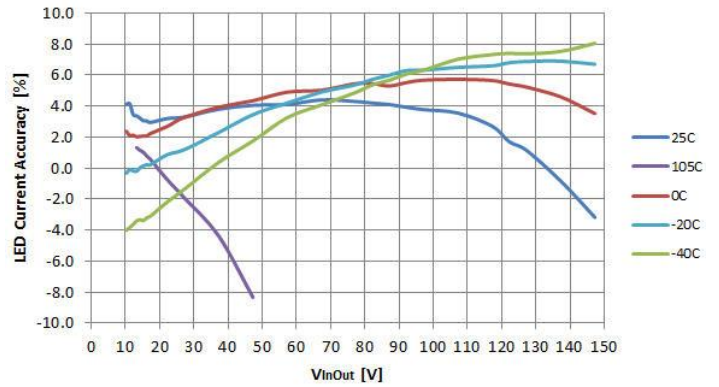

Figure 11. LED Current Accuracy (-40°C to +105°C) vs. V_{IN_OUT}

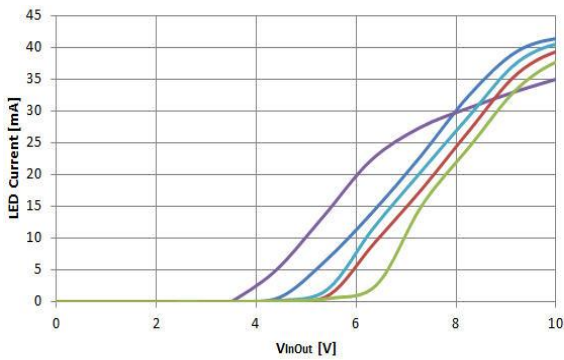

Figure 12. Device Turning On Threshold Across Temperature

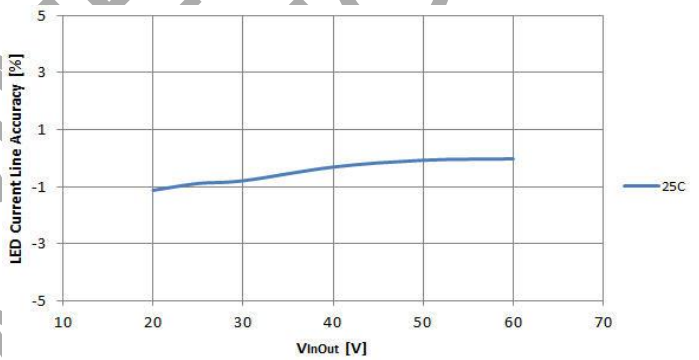

Figure 13. LED Line Regulation (% @ +25°C) vs. V_{IN_OUT} (20V to 60V)

NOT FOR NEW

Application Information

Description

The AL5890 is a constant current Linear LED driver and can be connected in series with LEDs as a High Side or a Low Side constant current regulator. The AL5890 offers various current settings from 10mA to 40mA and different current settings available upon request.

Simple LED String (AC/DC Configuration)

The AL5890 can be connected in series with LEDs as a Low Side or High Side constant current regulator. The number of the LEDs can vary from one to as many as supported by the input supply voltage. The designer needs to calculate the maximum voltage between IN pin and OUT pin by taking the maximum input voltage less the voltage across the LED string.

(AC Configuration)

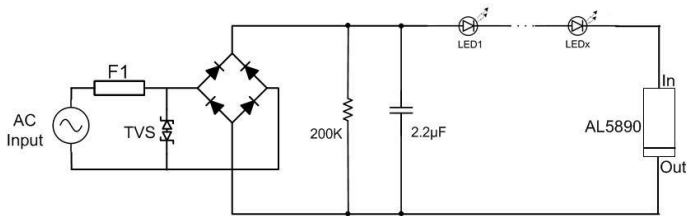

Figure 14. Low Side AC Application

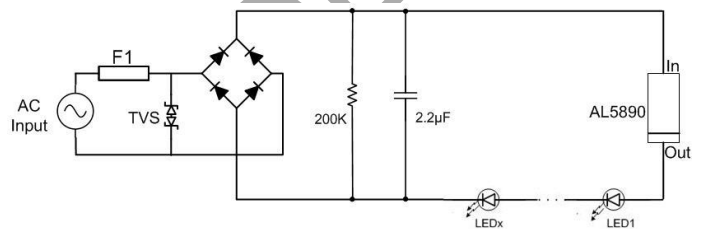

Figure 15. High Side AC Application

The AL5890 can also be used at the high side of the IC, see Figure 7. The minimum system input voltage can be calculated by:

$$V_{IN(MIN)} = V_{LED_CHAIN} + 7V, \text{ Where } V_{LED_CHAIN} \text{ is the LED chain voltage.}$$

(DC Configuration)

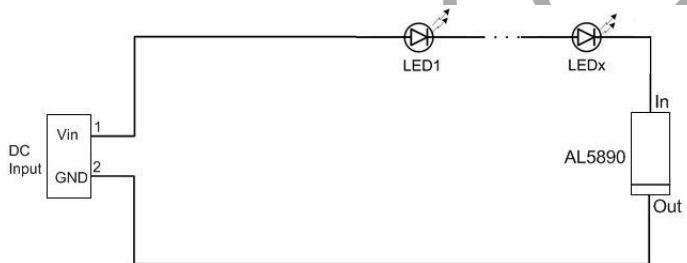

Figure 16. Low Side DC Application

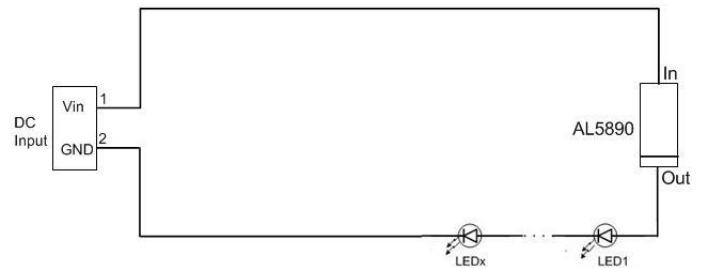

Figure 17. High Side DC Application

Application Information (Cont.)

Higher Current Requirement in Parallel Configuration

The LED current can be increased by connecting two or more AL5890 in parallel as Figure 10.

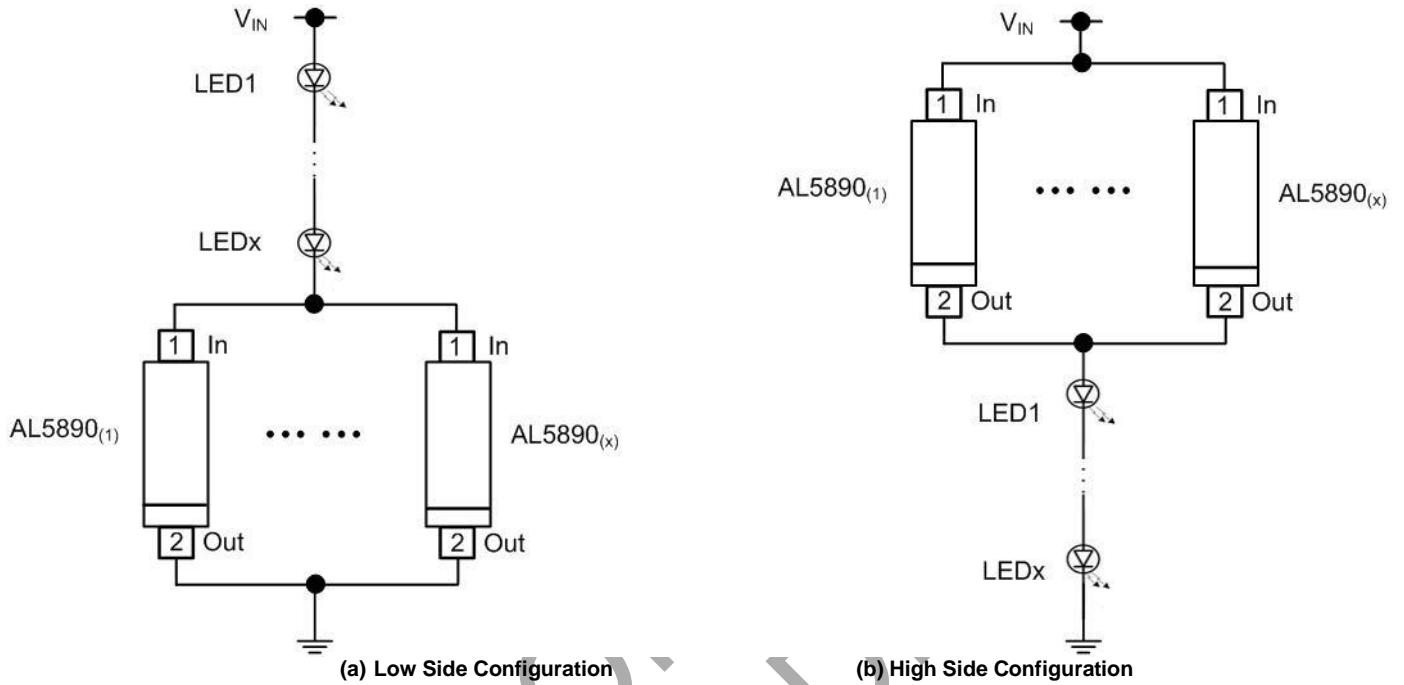

Figure 18. Parallel Configuration of AL5890

NOT RECOMMENDED FOR NEW DESIGN

Application Information (Cont.)

Thermal Fold-back Protection (TFP)

The AL5890 has a thermal fold-back protection (TFP) function and adopts self-adaptive control method, which can prevent the system from breaking down caused by high temperature. The typical overheating temperature is set at +130°C, when the junction temperature of the IC is higher than +130°C, the device will linearly decrease the internal reference voltage to decrease the output current. As a result of this feature, the device can control the system's output power at high ambient temperature, to control the quantity of heat of the system. This enhances the safety of the system at high temperature.

Thermal fold-back waveform AL5890-10mA (PowerDI123 (Type B) package, 1"x1" PCB with 2oz copper, no heatsink) with $V_{in_out} = 100V$ is shown as below:

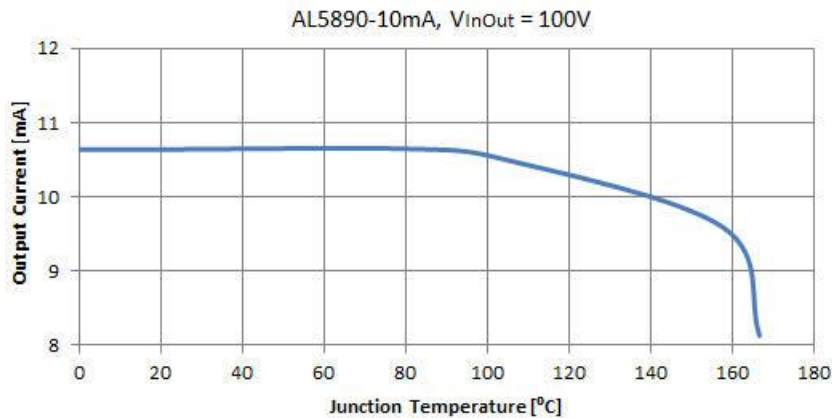

Figure 19. Thermal Foldback Characteristic

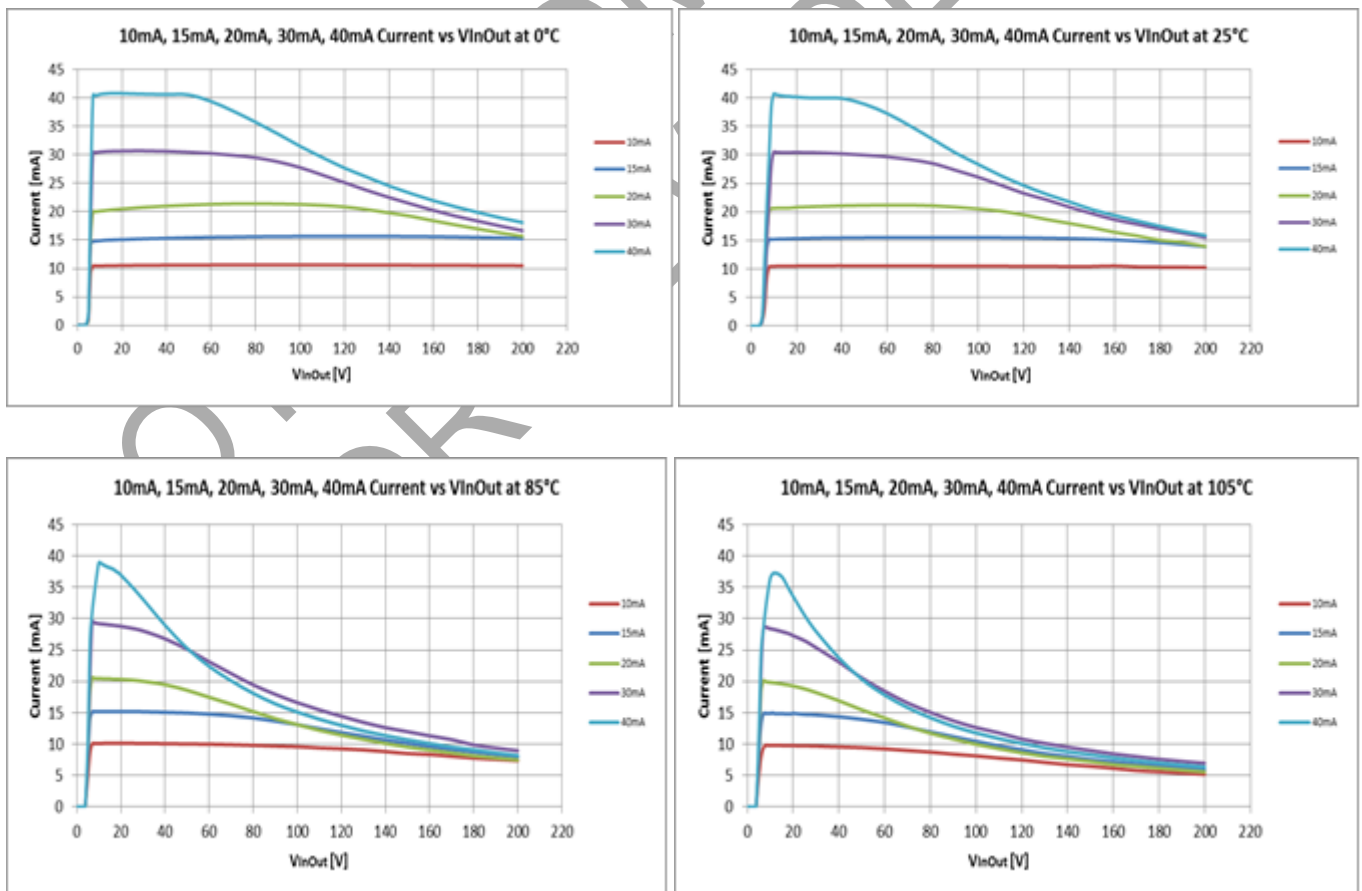
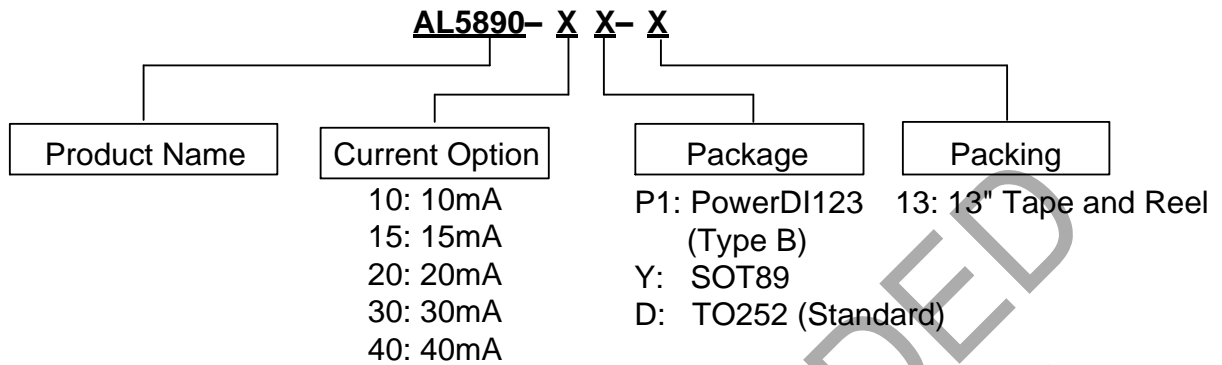

Figure 20. Thermal Foldback Characteristic with Different Current Option across Temperature

Ordering Information



Part Number	LED Current Option	Package Code	Packaging	13" Tape and Reel	
				Quantity	Part Number Suffix
AL5890-10P1-13	10mA	P1	PowerDI123 (Type B)	10,000/ Tape & Reel	-13
AL5890-15P1-13	15mA	P1	PowerDI123 (Type B)	10,000/ Tape & Reel	-13
AL5890-20P1-13	20mA	P1	PowerDI123 (Type B)	10,000/ Tape & Reel	-13
AL5890-30P1-13	30mA	P1	PowerDI123 (Type B)	10,000/ Tape & Reel	-13
AL5890-40P1-13	40mA	P1	PowerDI123 (Type B)	10,000/ Tape & Reel	-13
AL5890-10Y-13	10mA	Y	SOT89	2,500/ Tape & Reel	-13
AL5890-15Y-13	15mA	Y	SOT89	2,500/ Tape & Reel	-13
AL5890-20Y-13	20mA	Y	SOT89	2,500/ Tape & Reel	-13
AL5890-30Y-13	30mA	Y	SOT89	2,500/ Tape & Reel	-13
AL5890-40Y-13	40mA	Y	SOT89	2,500/ Tape & Reel	-13
AL5890-10D-13	10mA	D	TO252 (Standard)	2,500/ Tape & Reel	-13
AL5890-15D-13	15mA	D	TO252 (Standard)	2,500/ Tape & Reel	-13
AL5890-20D-13	20mA	D	TO252 (Standard)	2,500/ Tape & Reel	-13
AL5890-30D-13	30mA	D	TO252 (Standard)	2,500/ Tape & Reel	-13
AL5890-40D-13	40mA	D	TO252 (Standard)	2,500/ Tape & Reel	-13

NOT FOR NEW

Marking Information

(1) PowerDI123 (Type B)

(Top View)

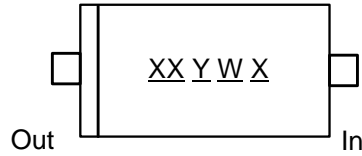

XX: Identification code

Y: Year 0 to 9

W: Week : A to Z : 1 to 26 week;
a to z : 27 to 52 week; z represents
52 and 53 week

X: Internal code

Part Number	Package	Identification Code
AL5890-10P1-13	PowerDI123 (Type B)	B2
AL5890-15P1-13	PowerDI123 (Type B)	B3
AL5890-20P1-13	PowerDI123 (Type B)	B4
AL5890-30P1-13	PowerDI123 (Type B)	B5
AL5890-40P1-13	PowerDI123 (Type B)	B6

(2) SOT89

(Top View)

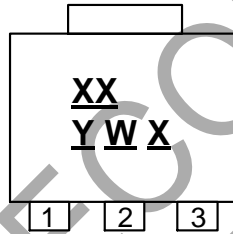

XX: Identification code

Y: Year : 0~9

W: Week : A~Z : 1~26 week;
a~z : 27~52 week;
z represents 52 and 53 week

X: Internal code

Part Number	Package	Identification Code
AL5890-10Y-13	SOT89	B2
AL5890-15Y-13	SOT89	B3
AL5890-20Y-13	SOT89	B4
AL5890-30Y-13	SOT89	B5
AL5890-40Y-13	SOT89	B6

(3) TO252 (Standard)

(Top View)

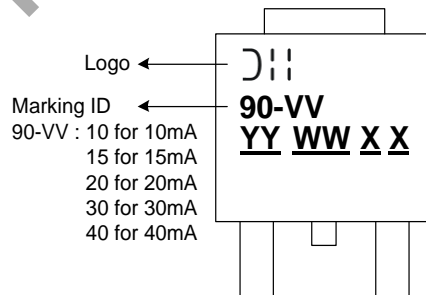

YY: Year : 01 to 09

WW: Week : 01 to 52, 52 represents
52 and 53 week

XX: Internal Code

Marking Information (Cont.)

Part Number	Package	Identification Code
AL5890-10D-13	TO252 (Standard)	B2
AL5890-15D-13	TO252 (Standard)	B3
AL5890-20D-13	TO252 (Standard)	B4
AL5890-30D-13	TO252 (Standard)	B5
AL5890-40D-13	TO252 (Standard)	B6

Package Outline Dimensions

Please see <http://www.diodes.com/package-outlines.html> for the latest version.

(1) PowerDI123 (Type B)

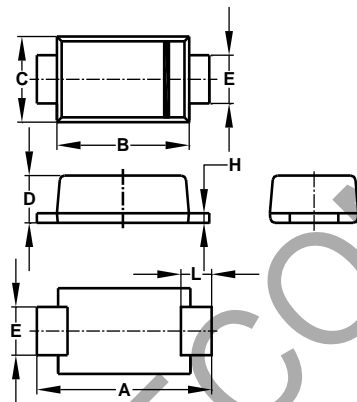

PowerDI123 (Type B)			
Dim	Min	Max	Typ
A	3.50	3.90	3.70
B	2.60	3.00	2.80
C	1.63	1.93	1.78
D	0.93	1.00	0.98
E	0.85	1.25	1.00
H	0.15	0.25	0.20
L	0.50	0.80	0.65
All Dimensions in mm			

(2) SOT89

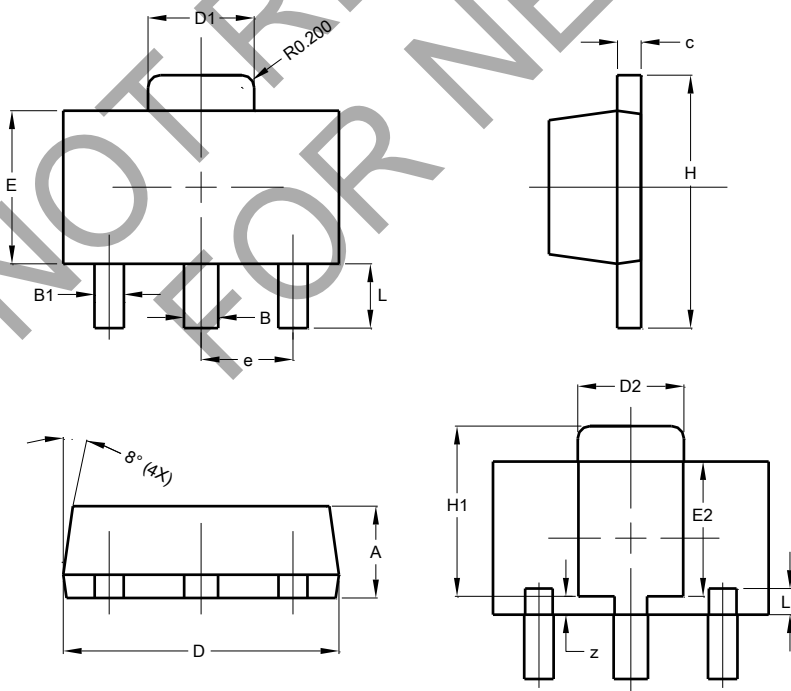

SOT89			
Dim	Min	Max	Typ
A	1.40	1.60	1.50
B	0.50	0.62	0.56
B1	0.42	0.54	0.48
c	0.35	0.43	0.38
D	4.40	4.60	4.50
D1	1.62	1.83	1.733
D2	1.61	1.81	1.71
E	2.40	2.60	2.50
E2	2.05	2.35	2.20
e	-	-	1.50
H	3.95	4.25	4.10
H1	2.63	2.93	2.78
L	0.90	1.20	1.05
L1	0.327	0.527	0.427
z	0.20	0.40	0.30
All Dimensions in mm			

Package Outline Dimensions (Cont.)

Please see <http://www.diodes.com/package-outlines.html> for the latest version.

(3) TO252 (Standard)

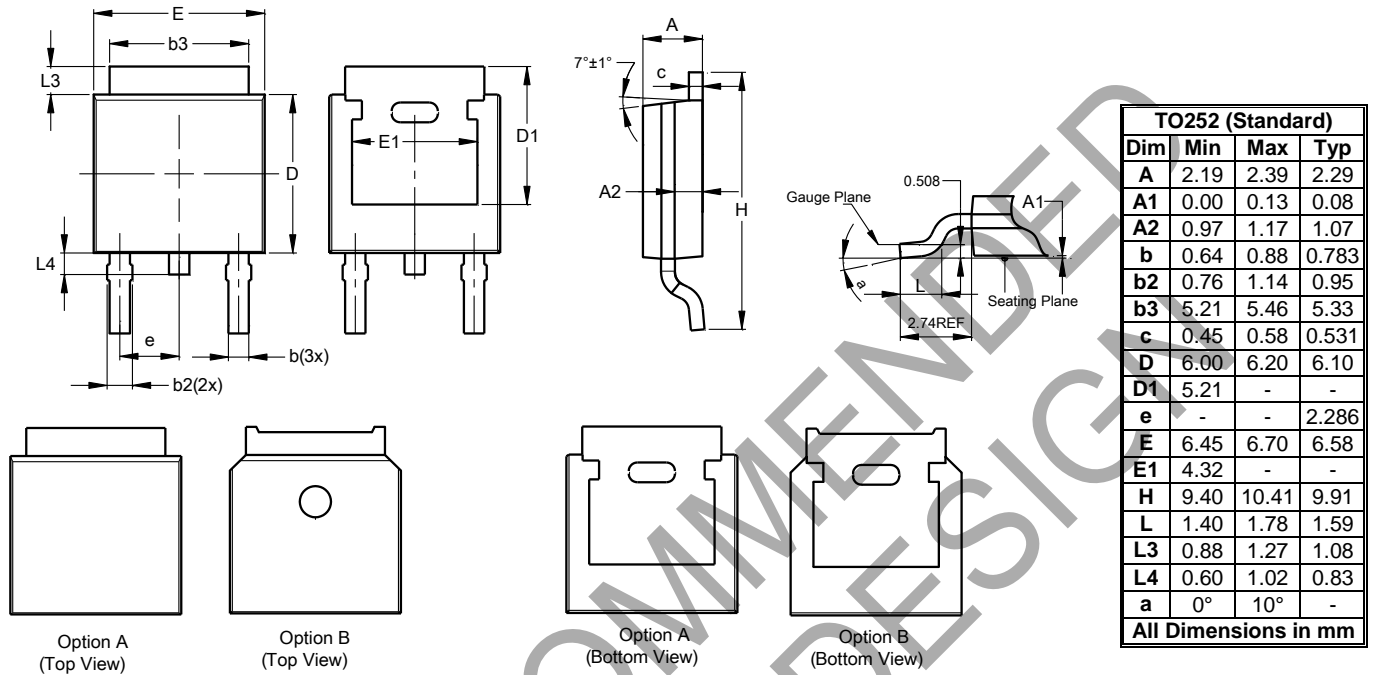

Suggested Pad Layout

Please see <http://www.diodes.com/package-outlines.html> for the latest version.

(1) PowerDI123 (Type B)

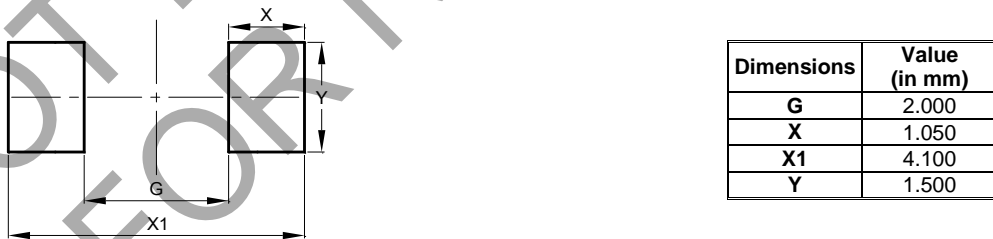

Suggested Pad Layout (Cont.)

Please see <http://www.diodes.com/package-outlines.html> for the latest version.

(2) SOT89

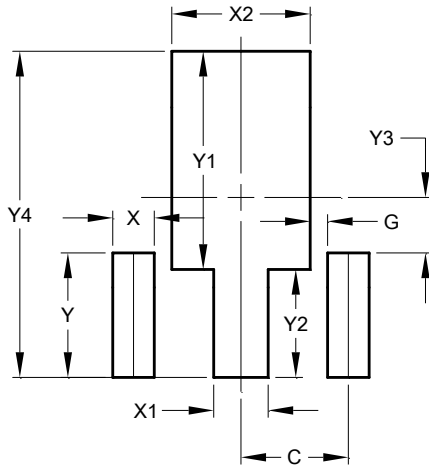

Dimensions	Value (in mm)
C	1.500
G	0.244
X	0.580
X1	0.760
X2	1.933
Y	1.730
Y1	3.030
Y2	1.500
Y3	0.770
Y4	4.530

(3) TO252 (Standard)

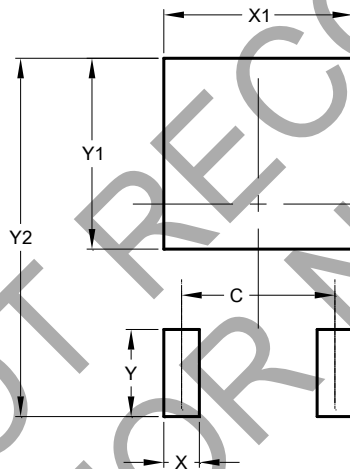

Dimensions	Value (in mm)
C	4.572
X	1.060
X1	5.632
Y	2.600
Y1	5.700
Y2	10.700

Taping Orientation

The taping orientation of the other package type can be found on our website at <http://www.diodes.com/datasheets/ap02007.pdf>.

PowerDI123 (Type B)

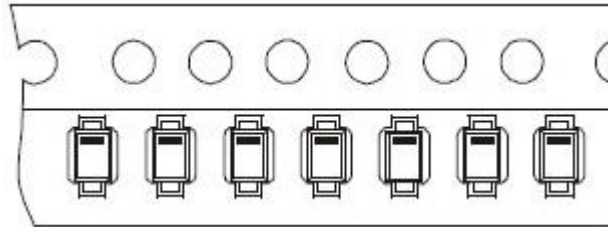

SOT89

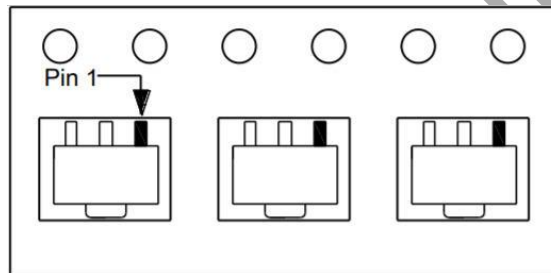

TO252 (Standard)

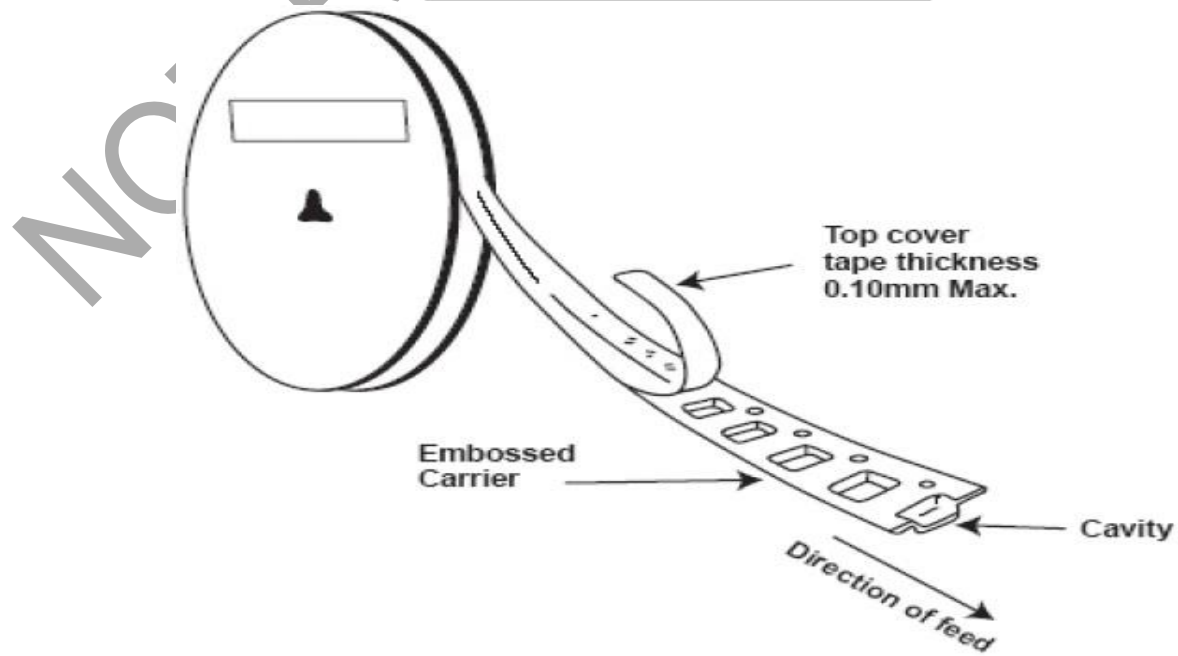
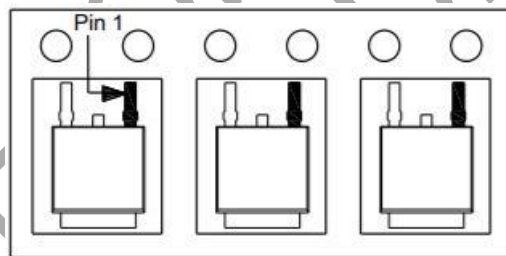

IMPORTANT NOTICE

1. DIODES INCORPORATED (Diodes) AND ITS SUBSIDIARIES MAKE NO WARRANTY OF ANY KIND, EXPRESS OR IMPLIED, WITH REGARDS TO ANY INFORMATION CONTAINED IN THIS DOCUMENT, INCLUDING, BUT NOT LIMITED TO, THE IMPLIED WARRANTIES OF MERCHANTABILITY, FITNESS FOR A PARTICULAR PURPOSE OR NON-INFRINGEMENT OF THIRD PARTY INTELLECTUAL PROPERTY RIGHTS (AND THEIR EQUIVALENTS UNDER THE LAWS OF ANY JURISDICTION).
2. The Information contained herein is for informational purpose only and is provided only to illustrate the operation of Diodes' products described herein and application examples. Diodes does not assume any liability arising out of the application or use of this document or any product described herein. This document is intended for skilled and technically trained engineering customers and users who design with Diodes' products. Diodes' products may be used to facilitate safety-related applications; however, in all instances customers and users are responsible for (a) selecting the appropriate Diodes products for their applications, (b) evaluating the suitability of Diodes' products for their intended applications, (c) ensuring their applications, which incorporate Diodes' products, comply the applicable legal and regulatory requirements as well as safety and functional-safety related standards, and (d) ensuring they design with appropriate safeguards (including testing, validation, quality control techniques, redundancy, malfunction prevention, and appropriate treatment for aging degradation) to minimize the risks associated with their applications.
3. Diodes assumes no liability for any application-related information, support, assistance or feedback that may be provided by Diodes from time to time. Any customer or user of this document or products described herein will assume all risks and liabilities associated with such use, and will hold Diodes and all companies whose products are represented herein or on Diodes' websites, harmless against all damages and liabilities.
4. Products described herein may be covered by one or more United States, international or foreign patents and pending patent applications. Product names and markings noted herein may also be covered by one or more United States, international or foreign trademarks and trademark applications. Diodes does not convey any license under any of its intellectual property rights or the rights of any third parties (including third parties whose products and services may be described in this document or on Diodes' website) under this document.
5. Diodes' products are provided subject to Diodes' Standard Terms and Conditions of Sale (<https://www.diodes.com/about/company/terms-and-conditions/terms-and-conditions-of-sales/>) or other applicable terms. This document does not alter or expand the applicable warranties provided by Diodes. Diodes does not warrant or accept any liability whatsoever in respect of any products purchased through unauthorized sales channel.
6. Diodes' products and technology may not be used for or incorporated into any products or systems whose manufacture, use or sale is prohibited under any applicable laws and regulations. Should customers or users use Diodes' products in contravention of any applicable laws or regulations, or for any unintended or unauthorized application, customers and users will (a) be solely responsible for any damages, losses or penalties arising in connection therewith or as a result thereof, and (b) indemnify and hold Diodes and its representatives and agents harmless against any and all claims, damages, expenses, and attorney fees arising out of, directly or indirectly, any claim relating to any noncompliance with the applicable laws and regulations, as well as any unintended or unauthorized application.
7. While efforts have been made to ensure the information contained in this document is accurate, complete and current, it may contain technical inaccuracies, omissions and typographical errors. Diodes does not warrant that information contained in this document is error-free and Diodes is under no obligation to update or otherwise correct this information. Notwithstanding the foregoing, Diodes reserves the right to make modifications, enhancements, improvements, corrections or other changes without further notice to this document and any product described herein. This document is written in English but may be translated into multiple languages for reference. Only the English version of this document is the final and determinative format released by Diodes.
8. Any unauthorized copying, modification, distribution, transmission, display or other use of this document (or any portion hereof) is prohibited. Diodes assumes no responsibility for any losses incurred by the customers or users or any third parties arising from any such unauthorized use.
9. This Notice may be periodically updated with the most recent version available at <https://www.diodes.com/about/company/terms-and-conditions/important-notice>

The Diodes logo is a registered trademark of Diodes Incorporated in the United States and other countries.
All other trademarks are the property of their respective owners.
© 2023 Diodes Incorporated. All Rights Reserved.

www.diodes.com

Looking for pricing, stock, or lifecycle information?

Click below to explore more details on WIN SOURCE:

 [View AL5890-20P1-13 on WIN SOURCE](#)

 [Diodes Incorporated](#) Information

Optimize Your Supply Chain with WIN SOURCE Solutions

-  Global Sourcing Solution
-  Obsolete Management
-  Cost Control Management
-  Shortage Management
-  Alternative Solution
-  Excess Inventory Management