



**THE DATASHEET OF  
DPO2039DABQ-13**



## Description

The DPO2039DABQ-13 provides 4 channels of over-voltage protection over the CC1/2 & DIFF1/2 pins which are connected to the USB Type-C connector. The 4 channels are divided into two pairs, one pair of channels protect the CC1 and CC2 pins from being shorted to the V<sub>BUS</sub>, one pair of channels protect the DIFF1 and DIFF2 pins from being shorted to the V<sub>BUS</sub>. Whenever the voltage threshold set for any of the two pairs of channels is reached, the exception condition becomes valid and the low-active flag FAULTB is subsequently asserted.

This device is designed to draw its operating voltage primarily from the system power, V<sub>SYS</sub>, which is either the always-ON 3.3/5V existed within the system or the 1-cell battery inside the mobile system. Under the circumstance when the battery inside a mobile system is fully depleted, DPO2039DABQ-13 can obtain power from the external peripheral system connected to the USB Type-C connector. The DPO2039DABQ-13 is housed in the low-profile and space-saving U-QFN3030-16 (Type B) package which is manufactured with environmental-friendly material.

## Features

- Operating Voltage Range: 2.7V to 5.5V
- 4-Channel Over-Voltage Protection with Auto-Recovery
- IEC 61000-4-2 ESD Protection over CCx and DIFFx Pins
- R<sub>DS(ON)</sub> of OVP MOSFET for CC-Pin Protection: 300mΩ Typical
- R<sub>DS(ON)</sub> of OVP MOSFET for DIFF-Pin Protection: 5Ω Typical
- C<sub>IN</sub> of OVP MOSFET for CC-Pin Protection: 50pF
- C<sub>IN</sub> of OVP MOSFET for DIFF-Pin Protection: 5pF
- Built-In Over-Temperature Protection
- **Totally Lead-Free & Fully RoHS Compliant (Notes 1 & 2)**
- **Halogen and Antimony Free. "Green" Device (Note 3)**
- **The DPO2039DABQ-13 is suitable for automotive applications requiring specific change control; this part is AEC-Q100 qualified, PPAP capable, and manufactured in IATF 16949 certified facilities.**  
<https://www.diodes.com/quality/product-definitions/>

- Notes:
1. No purposely added lead. Fully EU Directive 2002/95/EC (RoHS), 2011/65/EU (RoHS 2) & 2015/863/EU (RoHS 3) compliant.
  2. See <https://www.diodes.com/quality/lead-free/> for more information about Diodes Incorporated's definitions of Halogen- and Antimony-free, "Green" and Lead-free.
  3. Halogen- and Antimony-free "Green" products are defined as those which contain <900ppm bromine, <900ppm chlorine (<1500ppm total Br + Cl) and <1000ppm antimony compounds.

## Pin Assignments

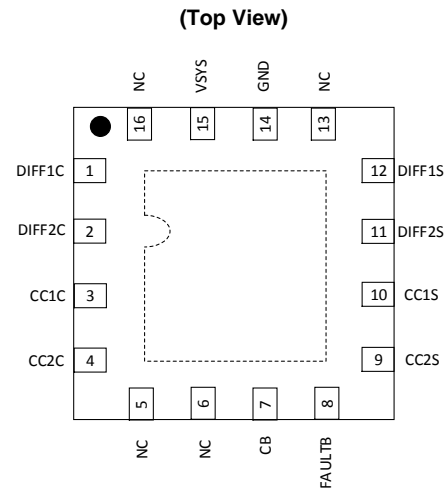

**U-QFN3030-16 (Type B)**

## Applications

- Notebook/Desktop/AIO PCs, Tablets, Mobile Phones
- VR/AR Headsets
- Docking Stations, Universal & Multimedia Hubs
- FPTVs, PC Monitors
- Set-Top-Boxes, Residential Gateways, Storage Devices
- Universal AC/DC Chargers/Adapters

**Typical Application Circuit**

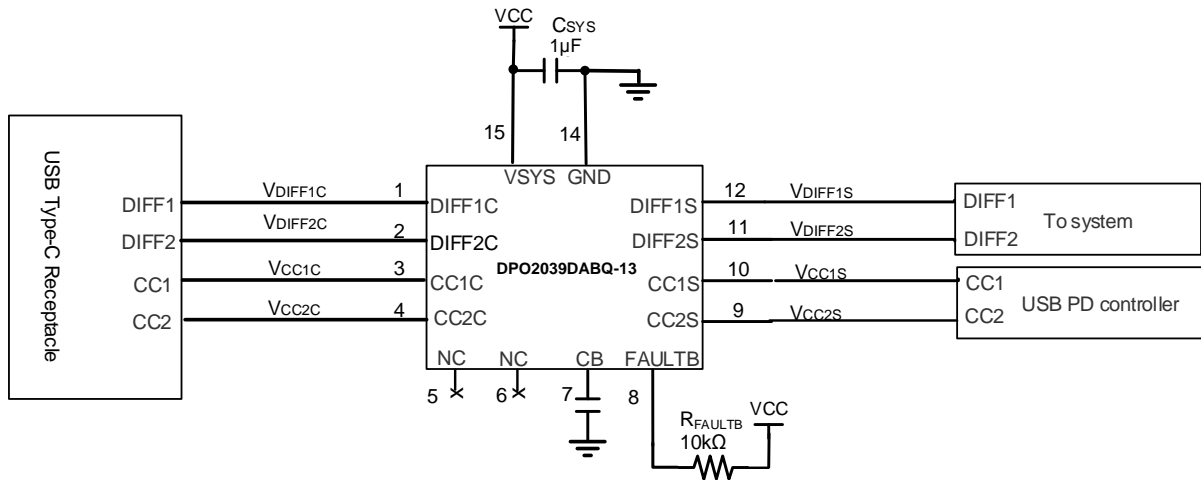
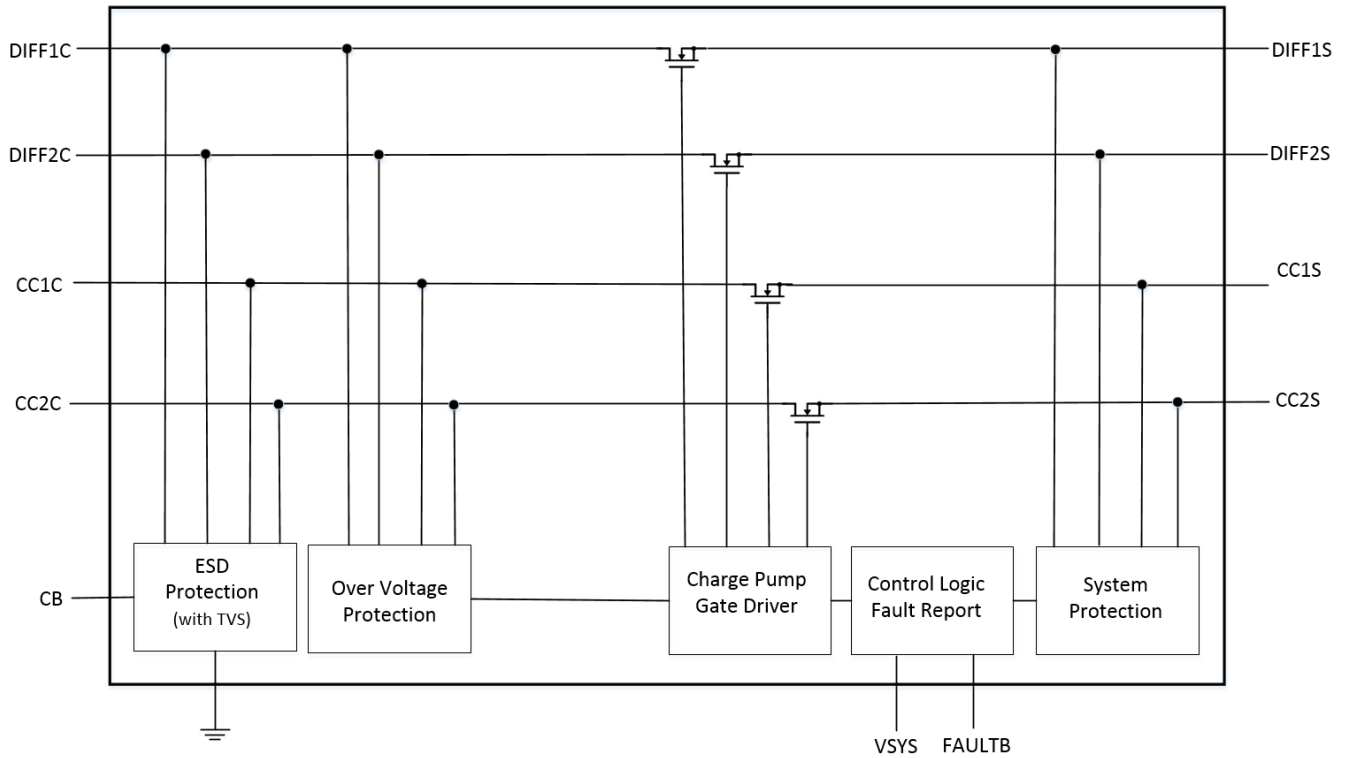

**Figure 1. Typical Application Circuit**

**Pin Descriptions**

Pin Number	Pin Name	Function
1	DIFF1C	DIFF1 connector side. This shall be connected to the DIFF1 pin of the USB Type-C connector.
2	DIFF2C	DIFF2 connector side. This shall be connected to the DIFF2 pin of the USB Type-C connector.
3	CC1C	CC1 connector side. This shall be connected to the CC1 pin of the USB Type-C connector.
4	CC2C	CC2 connector side. This shall be connected to the CC2 pin of the USB Type-C connector.
7	CB	Pin for ESD support capacitor. Place a 0.1µF capacitor on this pin to ground.
8	FAULTB	Fault status. This is an active-low open-drain output.
9	CC2S	CC2 system side. This shall be connected to the CC2 pin of the component to be protected.
10	CC1S	CC1 system side. This shall be connected to the CC1 pin of the component to be protected.
11	DIFF2S	DIFF2 system side. This shall be connected to the DIFF2 pin of the component to be protected.
12	DIFF1S	DIFF1 system side. This shall be connected to the DIFF1 pin of the component to be protected.
5, 6, 13, 16	NC	No connection.
14	GND	Ground.
15	VSYS	Power Input. This shall be connected to the 2.7 to 5.5V power source inside the system.
—	EP	Exposed pad. This shall be connected to ground.

**Functional Block Diagram**



**Figure 2. Internal Functional Blocks**

**Absolute Maximum Ratings** (@  $T_A = +25^\circ\text{C}$ , unless otherwise specified) (Note 4)

Symbol	Parameter	Rating	Unit
$V_{VSYS}$	Voltage Range of VSYS Pin	-0.3 to 6.0	V
$V_{FAULTB}$	Voltage Range of FAULTB Pin	-0.3 to 6.0	V
$V_{CB}$	Voltage Range of CB Pin	-0.3 to 24	V
$V_{DIFFxS}, V_{CCxS}$	Voltage Range of DIFF1S, DIFF2S, CC1S, CC2S Pins	-0.3 to 6.0	V
$V_{DIFFxC}, V_{CCxC}$	Voltage Range of DIFF1C, DIFF2C, CC1C, CC2C Pins	-0.3 to 24.0	V
$T_J$	Operating Junction Temperature	-40 to +150	$^\circ\text{C}$
$T_L$	Lead Temperature	+260	$^\circ\text{C}$
$T_{STG}$	Storage Temperature	-65 to +150	$^\circ\text{C}$
ESD	Human Body Model (HBM), JESD22-A114	$\pm 2.0$	kV
	Charge Device Model (CDM), JESD22-C101	$\pm 0.5$	

Note: 4. These are stress ratings only. Operation outside the absolute maximum ratings can cause device failure. Operation at the absolute maximum rating for extended periods can reduce device reliability.

**Package Thermal Data** (@  $T_A = +25^\circ\text{C}$ , unless otherwise specified) (Note 5)

Symbol	Parameter	Rating	Unit
$P_D$	Power Dissipation	1.75	W
$R_{\theta JA}$	Thermal Resistance, Junction-to-Ambient	73	$^\circ\text{C}/\text{W}$
$R_{\theta JC}$	Thermal Resistance, Junction-to-Case	12.7	$^\circ\text{C}/\text{W}$

Note: 5. Device mounted on FR-4 substrate PC board, 2oz copper, with 1" x 1" copper pad layout.

**Recommended Operating Conditions** (@  $T_A = +25^\circ\text{C}$ , unless otherwise specified.)

Symbol	Parameter	Min	Max	Unit
$V_{\text{SYS}}$	Input Supply Voltage at V <sub>SYS</sub> Pin	2.7	5.5	V
$V_{\text{FAULTB}}$	Power Rail for Pull-Up on FAULTB Pin	2.7	5.5	V
$V_{\text{CB}}$	Voltage across CB Pin	0	5.5	V
$V_{\text{CCxC}}, V_{\text{CCxS}}$	I/O Voltage at CC1C, CC2C, CC1S, CC2S Pins	0	5.5	V
$V_{\text{DIFFxC}}, V_{\text{DIFFxS}}$	I/O Voltage at DIFF1C, DIFF2C, DIFF1S, DIFF2S Pins	0	4.2	V
$I_{\text{VCCX}}$	Output Current Flowing into CCxS and out of CCxC, with $V_{\text{CCxS}} - V_{\text{CCxC}} \leq 250\text{mV}$	—	600	mA

**Electrical Characteristics** (@  $T_A = +25^\circ\text{C}$ ,  $V_{\text{SYS}} = 4.2\text{V}$ , unless otherwise specified.)

Symbol	Parameter	Test Conditions	Min	Typ	Max	Unit
<b>CC OVP Switches</b>						
$R_{\text{DS(ON)_CC}}$	On Resistance of CC OVP FETs	$V_{\text{CCxC}} = 5.5\text{V}, T_A = +85^\circ\text{C}$	—	300	450	m $\Omega$
		$V_{\text{CCxC}} = 5.5\text{V}, T_A = +105^\circ\text{C}$	—	300	480	m $\Omega$
$R_{\text{DS(ONFLAT)_CC}}$	On Resistance Flatness of CC OVP FETs	$V_{\text{CCxC}} = 0.1$ to $1.2\text{V}$	—	—	5	m $\Omega$
$C_{\text{ON\_CC}}$	Equivalent ON Capacitance	Capacitance from CCxC to CCxS or CCxS to GND when device is powered, ( $V_{\text{CCxC}} / V_{\text{CCxS}} = 0\text{V}$ to $1.2\text{V}$ )	—	50	—	pF
$V_{\text{TH\_OVP\_CCxC}}$	OVP Threshold on CCxC Signal	—	5.6	6	6.25	V
$V_{\text{TH\_OVP\_HYS\_CCxC}}$	OVP Hysteresis on CCxC Signal	—	—	140	—	mV
$BW_{\text{ON\_CC}}$ (Note 6)	CC Line ON Bandwidth Single Ended (-3dB)	Measured from CCxC to CCxS, 50 $\Omega$ system, $V_{\text{CM}} = 0.1\text{V}$ to $1.2\text{V}$	—	200	—	MHz
$V_{\text{SHT\_CCxC\_MAX}}$ (Note 6)	Short-to-VBUS Tolerance on the CCxC Pins	Hot-plug CCxC with a 1 meter USB Type-C cable, place a 30 $\Omega$ load on CCxS	—	—	24	V
$V_{\text{SHT\_CCxS\_CL}}$ (Note 6)	Short-to-VBUS Clamping Voltage on the CCxS Pins	Hot-plug CCxC with a 1 meter USB Type-C cable, place a 30 $\Omega$ load on CCxS. Hot plug voltage $V_{\text{CCxC}} = 24\text{V}$	—	7	—	V
<b>DIFF OVP Switches</b>						
$R_{\text{DS(ON)_DIFF}}$	On Resistance of DIFF OVP FETs	$V_{\text{DIFFxC}} = 3.6\text{V}, T_A = +85^\circ\text{C}$	—	5	—	$\Omega$
		$V_{\text{DIFFxC}} = 3.6\text{V}, T_A = +105^\circ\text{C}$	—	5	—	$\Omega$
$R_{\text{DS(ONFLAT)_DIFF}}$	On Resistance Flatness of DIFF OVP FETs	$V_{\text{DIFFxC}} = 0.1$ to $3.6\text{V}$	—	—	1	$\Omega$
$C_{\text{ON\_DIFF}}$	Equivalent ON Capacitance	Capacitance from DIFFxC or DIFFxS to GND when device is powered. $V_{\text{DIFFxC}} / V_{\text{DIFFxS}} = 0\text{V}$ to $3.6\text{V}$	—	5	—	pF
$V_{\text{TH\_OVP\_DIFFxC}}$	OVP Threshold on DIFFxC Signals	—	4.15	4.5	4.75	V
$V_{\text{TH\_OVP\_HYS\_DIFFxC}}$	OVP Hysteresis on DIFFxC Signals	—	—	110	—	mV
$BW_{\text{ON\_DIFF}}$ (Note 6)	DIFF line ON Bandwidth Single Ended (-3dB)	Measured from DIFFxC to DIFFxS, 50 $\Omega$ system, $V_{\text{CM}} = 0.1\text{V}$ to $3.6\text{V}$	—	100 0	—	MHz
$V_{\text{SHTBUS\_DIFFxC\_MAX}}$ (Note 6)	Short-to-VBUS Tolerance on the DIFFxC Pins	Hot-plug DIFFxC with a 1 meter USB Type-C cable, place a 40 $\Omega$ in series with 150nF to GND on DIFFxS pin	—	—	24	V
$V_{\text{SHTBUS\_DIFFxS\_CL}}$ (Note 6)	Short-to-VBUS Clamping Voltage on the DIFFxS Pins	Hot-plug DIFFxC with a 1 meter USB Type-C cable, place a 40 $\Omega$ in series with 100nF to GND on DIFFxS pin. Hot plug voltage $V_{\text{DIFFxC}} = 24\text{V}, V_{\text{SYS}} = 3.3\text{V}$	—	7	—	V
$X_{\text{TALK\_DIFFx}}$ (Note 6)	Crosstalk between DIFFx Lines	Measure crosstalk at $f = 1\text{MHz}$ , from DIFF1S to DIFF2C or DIFF2 to DIFF1C. $V_{\text{CM1}} = 3.6\text{V}, V_{\text{CM2}} = 0.3\text{V}$ , terminate open sides to 50 $\Omega$	—	-80	—	dB

**Electrical Characteristics** (@  $T_A = +25^\circ\text{C}$ ,  $V_{\text{SYS}} = 4.2\text{V}$ , unless otherwise specified) (continued)

Symbol	Parameter	Test Conditions	Min	Typ	Max	Unit
<b>Power Supply and Leakage Current</b>						
V <sub>UVLO</sub>	V <sub>SYS</sub> under Voltage Lockout	V <sub>SYS</sub> steps up from 2V until CC or DIFF FETs turn ON	2.15	2.4	2.55	V
V <sub>UVLO_HS</sub>	V <sub>SYS</sub> UVLO Hysteresis	V <sub>SYS</sub> steps down from 2.5V until CC or DIFF FETs turn off. Measure difference between rising and falling UVLO to calculate	—	200	—	mV
I <sub>VSYS_ON</sub>	V <sub>SYS</sub> Supply Current	—	—	190	—	μA
I <sub>LEAK_CCx</sub>	Leakage current for CCx when device is powered	V <sub>CCx</sub> = 3.6V	—	—	30	μA
I <sub>LEAK_DIFFx</sub>	Leakage current for DIFFx when device is powered	V <sub>DIFFx</sub> = 3.6V	—	—	35	μA
I <sub>LEAK_CCxS</sub>	Leakage current for CCxS when device is powered	V <sub>CCx</sub> = 3.6V	—	—	30	μA
I <sub>LEAK_DIFFxS</sub>	Leakage current for DIFFxS when device is powered	V <sub>DIFFx</sub> = 3.6V	—	—	35	μA
I <sub>LEAK_OVP_CCx</sub>	Leakage current into CCx pins when device is in OVP	V <sub>SYS</sub> = 0V, V <sub>CCx</sub> = 22V, V <sub>CCxS</sub> = 0V	—	—	150	μA
		V <sub>SYS</sub> = 4.2V, V <sub>CCx</sub> = 22V, V <sub>CCxS</sub> = 0V	—	—	150	μA
I <sub>LEAK_OVP_DIFFx</sub>	Leakage current into DIFFx pins when device is in OVP	V <sub>SYS</sub> = 0V, V <sub>DIFFx</sub> = 22V, V <sub>DIFFxS</sub> = 0V	—	—	200	μA
		V <sub>SYS</sub> = 4.2V, V <sub>DIFFx</sub> = 22V, V <sub>DIFFxS</sub> = 0V	—	—	200	μA
I <sub>LEAK_OVP_CCxS</sub>	Leakage current out of CCxS pins when device is in OVP	V <sub>SYS</sub> = 0V, V <sub>CCx</sub> = 22V, V <sub>CCxS</sub> = 0V	—	—	1	μA
		V <sub>SYS</sub> = 4.2V, V <sub>CCx</sub> = 22V, V <sub>CCxS</sub> = 0V	—	—	1	μA
I <sub>LEAK_OVP_DIFFxS</sub>	Leakage current out of DIFFxS pins when device is in OVP	V <sub>SYS</sub> = 0V, V <sub>DIFFx</sub> = 22V, V <sub>DIFFxS</sub> = 0V	—	—	1	μA
		V <sub>SYS</sub> = 4.2V, V <sub>DIFFx</sub> = 22V, V <sub>DIFFxS</sub> = 0V	—	—	1	μA
<b>FAULTB Pin</b>						
V <sub>FAULTB</sub>	Active-Low Output Voltage of FAULTB Pin	I <sub>OL</sub> = 8mA	—	—	0.4	V
I <sub>LEAK_FAULTB</sub>	FAULTB Leakage Current	V <sub>FAULTB</sub> = 4.2V	—	—	1	μA
t <sub>FAULTB_ASSERTION</sub>	FAULTB Assertion Time	—	—	—	300	μs
t <sub>FAULTB_DEASSERTION</sub>	FAULTB Deassertion Time	—	—	4	—	ms
<b>Timing Requirements</b>						
t <sub>ON</sub>	Time from Crossing Rising V <sub>SYS</sub> UVLO until CC/DIFF OVP FETs are on	—	—	—	2.5	ms
t <sub>OVP_RESPONSE_CC</sub>	OVP Response Time on the CC Pins, Time from OVP Asserted until OVP FETs Turnoff	—	—	100	—	ns
t <sub>OVP_RESPONSE_DIFF</sub>	OVP Response Time on the DIFF Pins, Time from OVP Asserted until OVP FETs Turnoff	—	—	100	—	ns
t <sub>OVP_RESPONSE_CC_1</sub>	OVP Recovery Time on the CC Pins. Once an OVP has occurred, the minimum duration until CC FETs turn back on if OVP has been removed already	—	26	32	38	ms
t <sub>OVP_RESPONSE_DIFF_1</sub>	OVP Recovery Time on the DIFF Pins. Once an OVP has occurred, the minimum duration until DIFF FETs turn back on if OVP has been removed already	—	26	32	38	ms
t <sub>OVP_RESPONSE_CC_2</sub>	OVP Recovery Time on the CC Pins. Time from OVP removal until CC FETs turn back on, if device has been in OVP > 40ms	—	—	1	—	ms
t <sub>OVP_RESPONSE_DIFF_2</sub>	OVP Recovery Time on the DIFF Pins. Time from OVP removal until DIFF FETs turn back on, if device has been in OVP > 40ms	—	—	1	—	ms
<b>Thermal Shutdown and Hysteresis</b>						
T <sub>SHDN</sub>	Thermal Shut Down Threshold	—	—	+150	—	°C
T <sub>HSYS</sub>	Thermal Shut Down Hysteresis	—	—	+20	—	°C

Note: 6. Guaranteed by bench characterization

**Performance Characteristics** (@  $T_A = +25^\circ\text{C}$ , unless otherwise specified.)

NEW PRODUCT

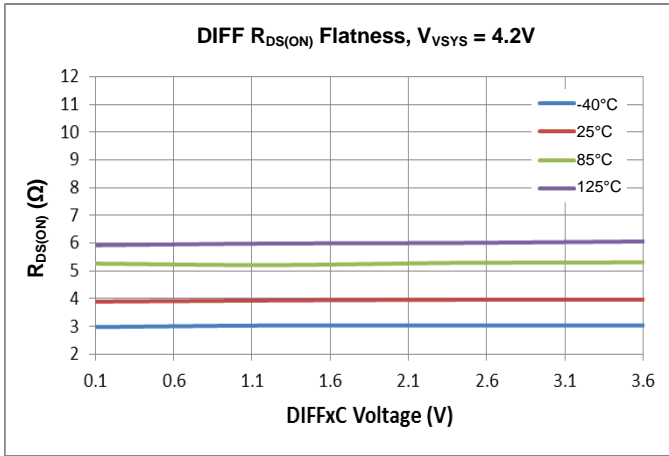

Figure 3. DIFF  $R_{DS(ON)}$  Flatness

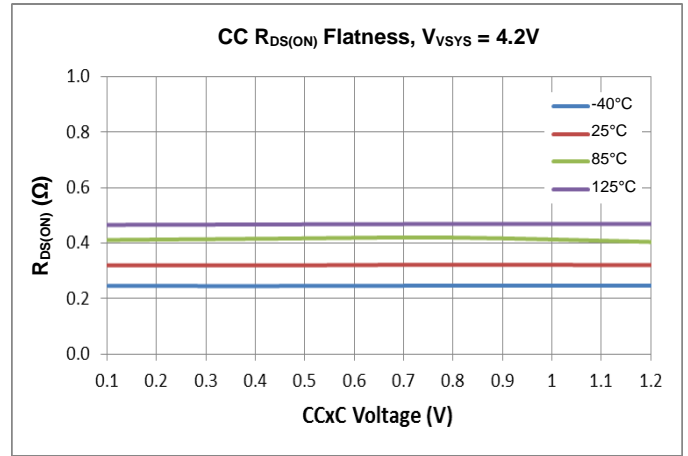

Figure 4. CC  $R_{DS(ON)}$  Flatness

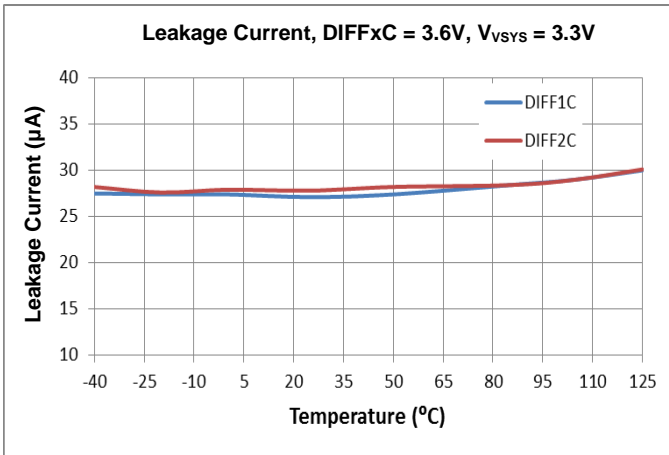

Figure 5. DIFFx C Leakage Current vs. Temperature

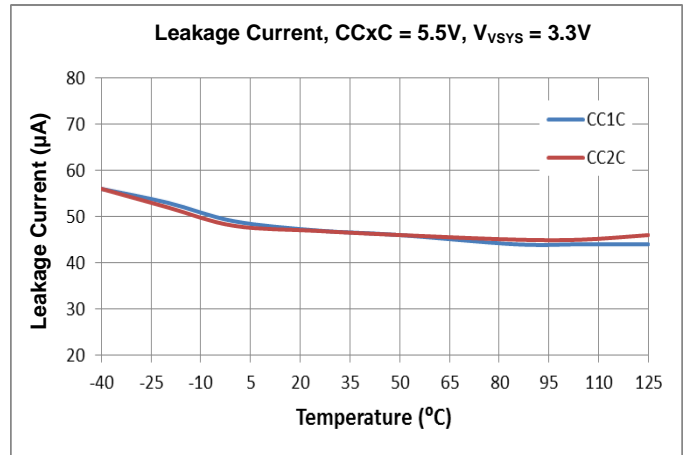

Figure 6. CCx C Leakage Current vs. Temperature

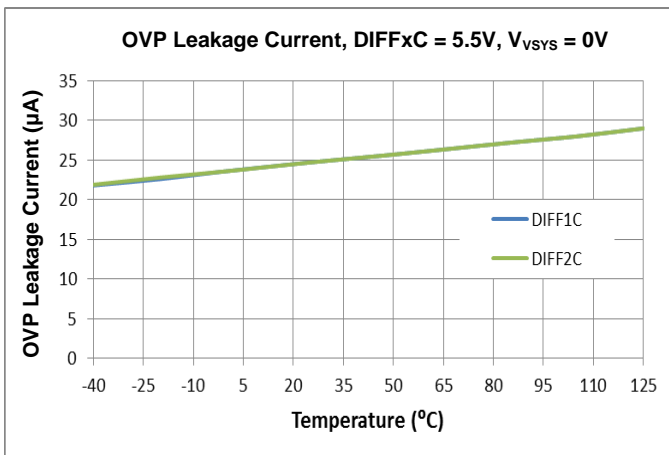

Figure 7. DIFFx C 5.5V OVP Leakage Current vs. Temperature

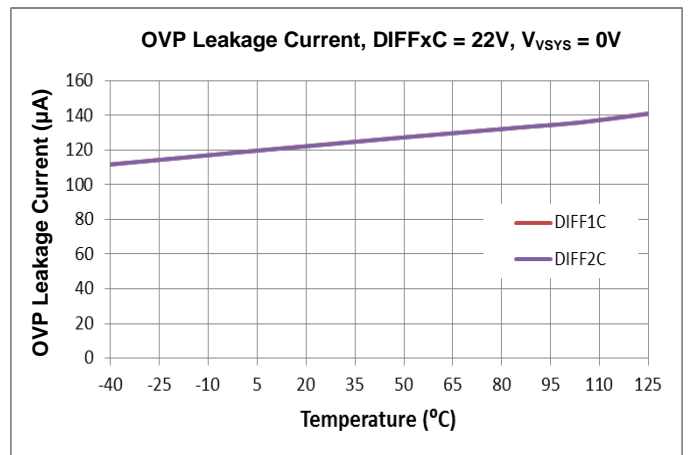

Figure 8. DIFFx C 22V OVP Leakage Current vs. Temperature

**Performance Characteristics** (@  $T_A = +25^\circ\text{C}$ , unless otherwise specified.) (continued)

NEW PRODUCT

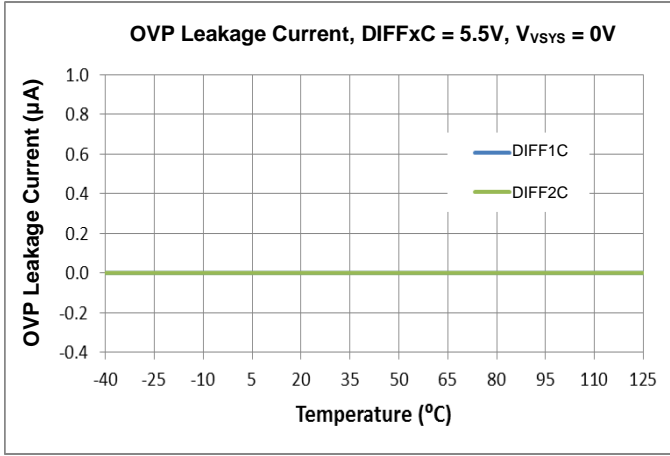

Figure 9. DIFFxC OVP Leakage Current vs. Temperature

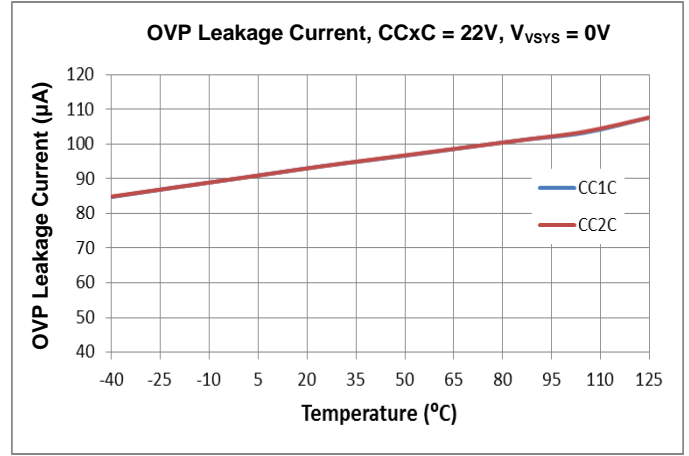

Figure 10. CCxC OVP Leakage Current vs. Temperature

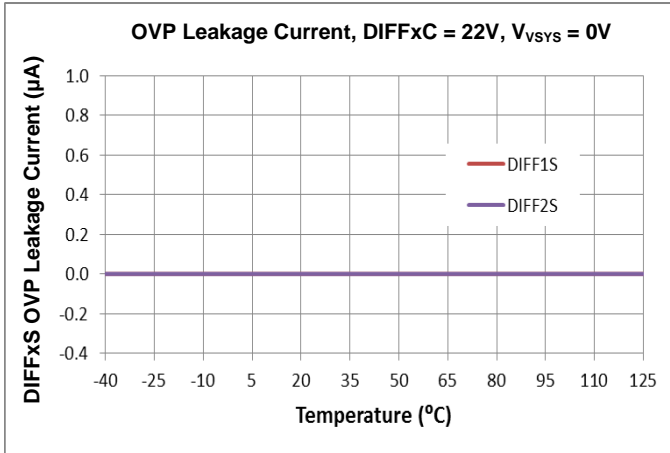

Figure 11. DIFFxS OVP Leakage Current vs. Temperature

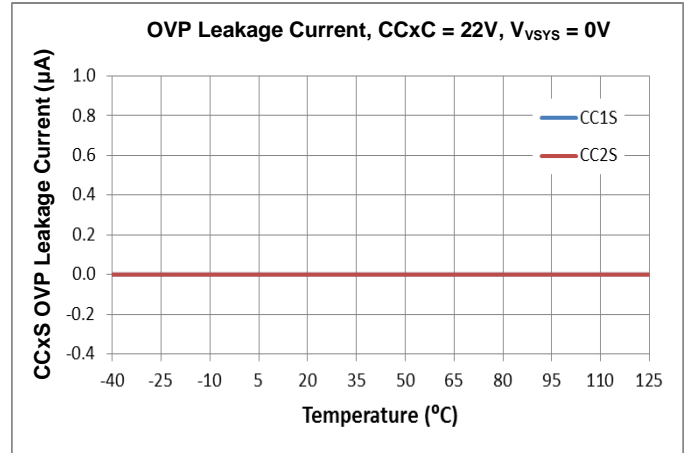

Figure 12. CCxS OVP Leakage Current vs. Temperature

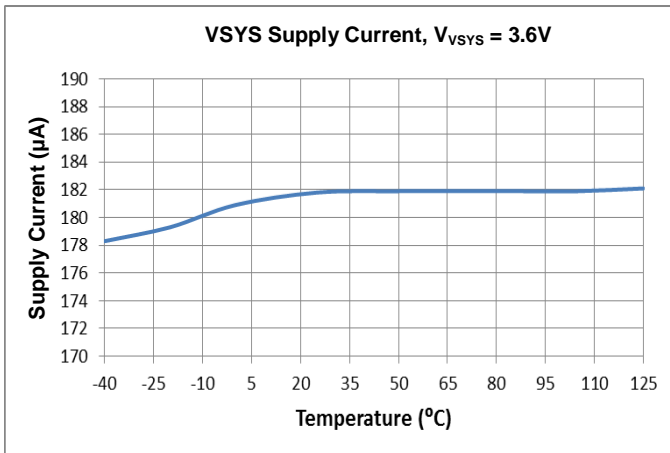

Figure 13. V\_VSYS Supply Current vs. Temperature

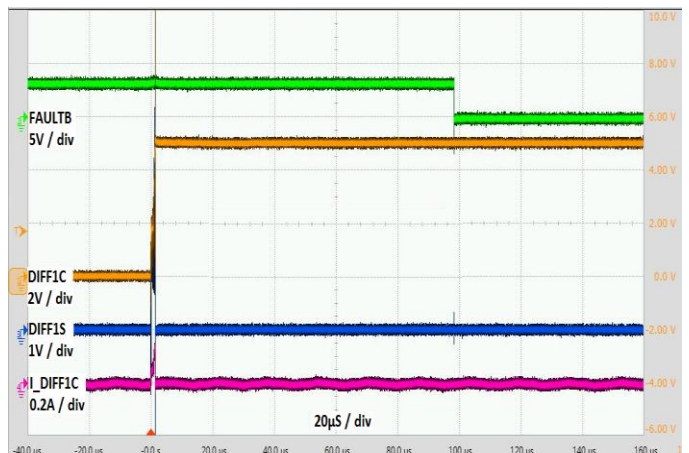
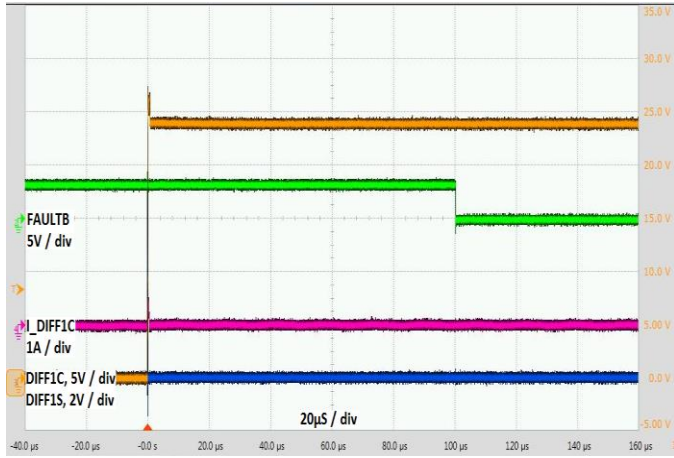
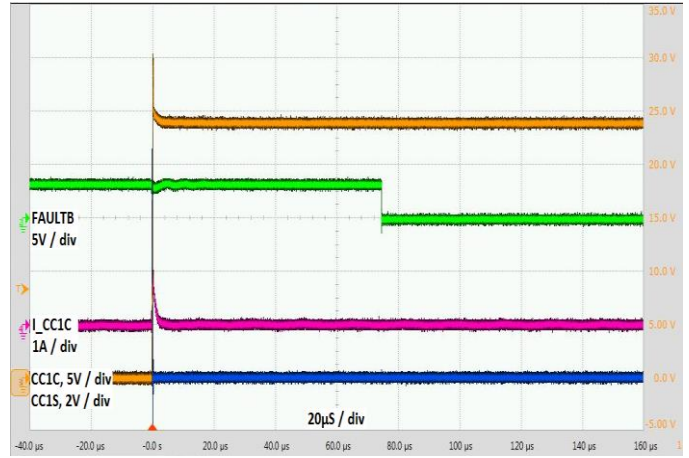

Figure 14. DIFF1C Short to 5V V\_Bus

**Performance Characteristics** (@  $T_A = +25^\circ\text{C}$ , unless otherwise specified.) (continued)



**Figure 15. DIFF1C Short to 24V Vbus**



**Figure 16. CC1C Short to 24V Vbus**

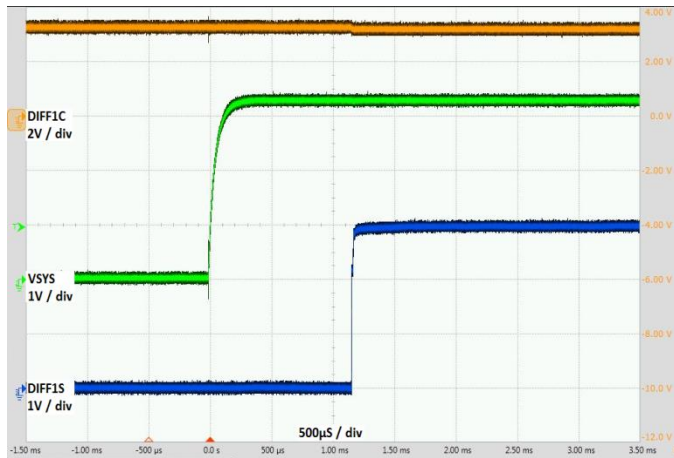

**Figure 17. DIFF MOSFET Turn-On Time**

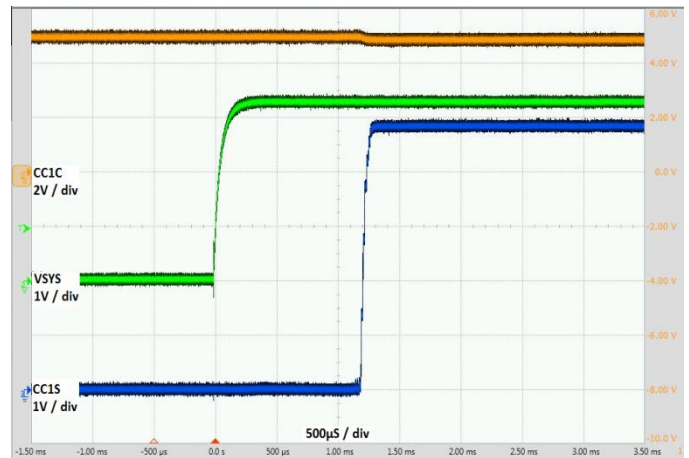

**Figure 18. CC MOSFET Turn-On Time**

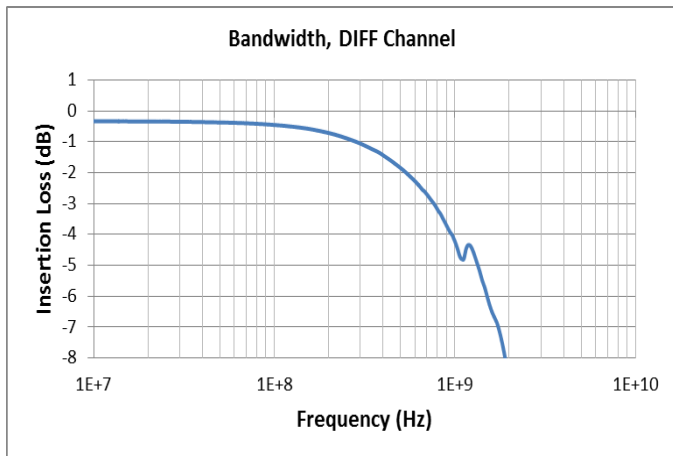

**Figure 19. DIFF Channel Bandwidth**

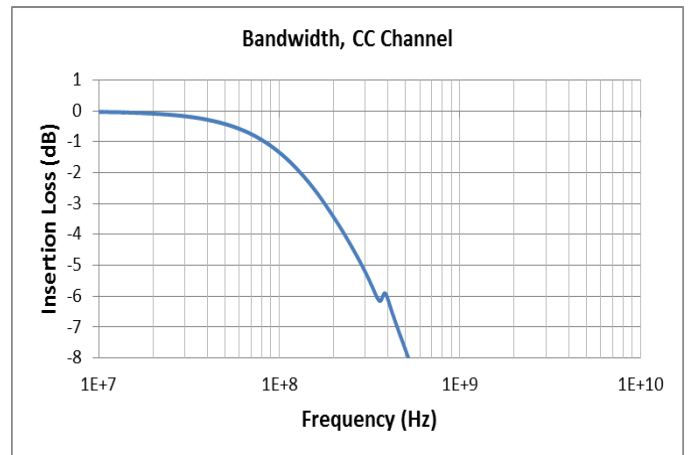

**Figure 20. CC Channel Bandwidth**

**Performance Characteristics** (@  $T_A = +25^\circ\text{C}$ , unless otherwise specified.) (continued)

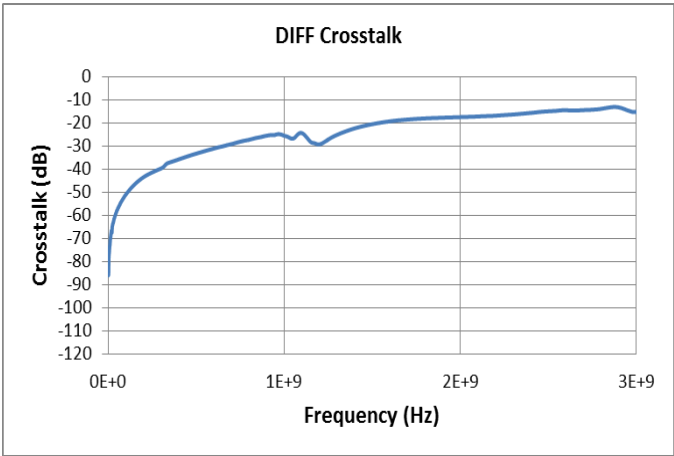

Figure 21. DIFF Crosstalk

## Application Information

### General Description

The DPO2039DABQ-13 is a USB port protection device designed to work with USB Type-C connector, cable and USB PD to form a system that enables signal management and power delivery in a compact package. It provides short to VBUS protection for the CC and DIFF pins over the USB Type-C connector.

### Short to VBUS Protection

The DPO2039DABQ-13 is a 4-channel uni-directional power switch with over-voltage protection. This is used to prevent the components inside a system which adopts the USB Type-C connector from being damaged by unexpected hazard. On the USB Type-C connector, the CC and DIFF pins are located in the close proximity of the VBUS pin. If ever the CC and/or the DIFF lines are short to the VBUS line either at the USB-C connector or at the cable end, the components (mostly ICs manufactured on the various sub-micron process nodes) behind the USB Type-C connector can easily be damaged by the resulting EOS. The damage, if occurred, is likely non-recoverable especially given that the voltage level on the VBUS line can go up to 20V or slightly higher. The DPO2039DABQ-13 integrates four series over-voltage FETs to protect the system side CC and DIFF lines. When either line on the Type-C connector side CC1C, CC2C, DIFF1C or DIFF2C is shorted to VBUS line, the DPO2039DABQ-13 will turn off the over-voltage FETs in less than 100ns window to isolate the system side CC and DIFF lines from the over-voltage connector side. When shorted to VBUS line is detected, the open-drain FAULTB will output low to indicate a fault condition.

### Signal Operation Range

Table 1 and Table 2 show the signal operation range and output status:

0V to UVLO (Invalid)	0V to 5.85V	OFF
	5.85V to 20V	OFF
2.7V to 5.5V (Valid)	0V to 5.85V	ON
	5.85V to 20V	OFF: FAULTB Asserted (OVP detected)

**Table 1. Signal Operation Range for CCx**

0V to UVLO (Invalid)	0V to 4.35V	OFF
	4.35V to 20V	OFF
2.7V to 5.5V (Valid)	0V to 4.35V	ON
	4.35V to 20V	OFF: FAULTB Asserted (OVP detected)

**Table 2. Signal Operation Range for DIFFx**

**Ordering Information** (Note 7)

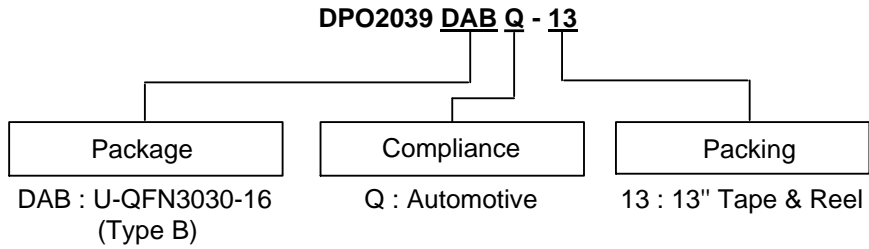

Part Number	Marking ID	Reel Size (inches)	Tape Width (mm)	13" Tape and Reel	
				Quantity	Part Number Suffix
DPO2039DABQ-13	PO39	13	8	3,000/Tape & Reel	-13

Note: 7. For packaging details, go to our website at <https://www.diodes.com/design/support/packaging/diodes-packaging/>.

**Marking Information**

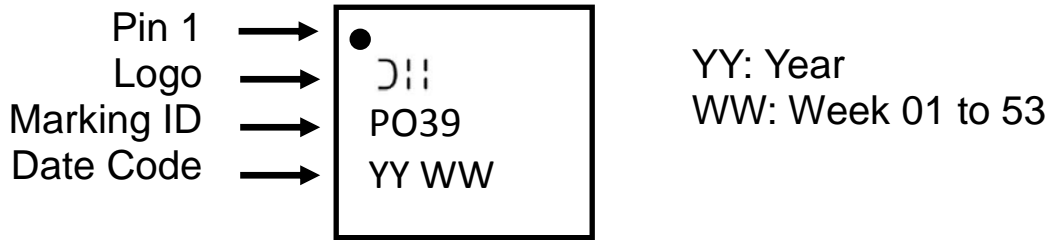

## Package Outline Dimensions

Please see <http://www.diodes.com/package-outlines.html> for the latest version.

U-QFN3030-16 (Type B)

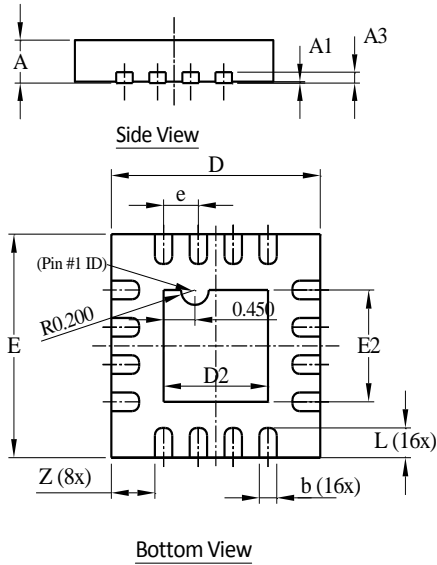

U-QFN3030-16 Type B			
Dim	Min	Max	Typ
A	0.55	0.65	0.60
A1	0	0.05	0.02
A3	-	-	0.15
b	0.18	0.28	0.23
D	2.95	3.05	3.00
D2	1.40	1.60	1.50
E	2.95	3.05	3.00
E2	1.40	1.60	1.50
e	-	-	0.50
L	0.35	0.45	0.40
Z	-	-	0.625
All Dimensions in mm			

## Suggested Pad Layout

Please see <http://www.diodes.com/package-outlines.html> for the latest version.

U-QFN3030-16 (Type B)

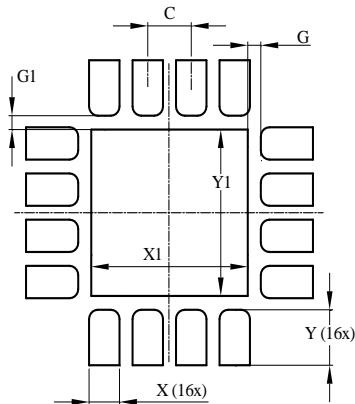

Dimensions	Value (in mm)
C	0.500
G	0.150
G1	0.150
X	0.350
X1	1.800
Y	0.600
Y1	1.800

**IMPORTANT NOTICE**

DIODES INCORPORATED MAKES NO WARRANTY OF ANY KIND, EXPRESS OR IMPLIED, WITH REGARDS TO THIS DOCUMENT, INCLUDING, BUT NOT LIMITED TO, THE IMPLIED WARRANTIES OF MERCHANTABILITY AND FITNESS FOR A PARTICULAR PURPOSE (AND THEIR EQUIVALENTS UNDER THE LAWS OF ANY JURISDICTION).

Diodes Incorporated and its subsidiaries reserve the right to make modifications, enhancements, improvements, corrections or other changes without further notice to this document and any product described herein. Diodes Incorporated does not assume any liability arising out of the application or use of this document or any product described herein; neither does Diodes Incorporated convey any license under its patent or trademark rights, nor the rights of others. Any Customer or user of this document or products described herein in such applications shall assume all risks of such use and will agree to hold Diodes Incorporated and all the companies whose products are represented on Diodes Incorporated website, harmless against all damages.

Diodes Incorporated does not warrant or accept any liability whatsoever in respect of any products purchased through unauthorized sales channel. Should Customers purchase or use Diodes Incorporated products for any unintended or unauthorized application, Customers shall indemnify and hold Diodes Incorporated and its representatives harmless against all claims, damages, expenses, and attorney fees arising out of, directly or indirectly, any claim of personal injury or death associated with such unintended or unauthorized application.

Products described herein may be covered by one or more United States, international or foreign patents pending. Product names and markings noted herein may also be covered by one or more United States, international or foreign trademarks.

This document is written in English but may be translated into multiple languages for reference. Only the English version of this document is the final and determinative format released by Diodes Incorporated.

**LIFE SUPPORT**

Diodes Incorporated products are specifically not authorized for use as critical components in life support devices or systems without the express written approval of the Chief Executive Officer of Diodes Incorporated. As used herein:

A. Life support devices or systems are devices or systems which:

1. are intended to implant into the body, or
2. support or sustain life and whose failure to perform when properly used in accordance with instructions for use provided in the labeling can be reasonably expected to result in significant injury to the user.

B. A critical component is any component in a life support device or system whose failure to perform can be reasonably expected to cause the failure of the life support device or to affect its safety or effectiveness.



Customers represent that they have all necessary expertise in the safety and regulatory ramifications of their life support devices or systems, and acknowledge and agree that they are solely responsible for all legal, regulatory and safety-related requirements concerning their products and any use of Diodes Incorporated products in such safety-critical, life support devices or systems, notwithstanding any devices- or systems-related information or support that may be provided by Diodes Incorporated. Further, Customers must fully indemnify Diodes Incorporated and its representatives against any damages arising out of the use of Diodes Incorporated products in such safety-critical, life support devices or systems.

Copyright © 2019, Diodes Incorporated

[www.diodes.com](http://www.diodes.com)

## Looking for pricing, stock, or lifecycle information?

Click below to explore more details on WIN SOURCE:

-  [View DPO2039DABQ-13 on WIN SOURCE](#)
-  [Diodes Incorporated Information](#)

## Optimize Your Supply Chain with WIN SOURCE Solutions

-  Global Sourcing Solution
-  Obsolete Management
-  Cost Control Management
-  Shortage Management
-  Alternative Solution
-  Excess Inventory Management