



**THE DATASHEET OF  
MAL219690112E3**



## Hybrid Energy Storage Capacitors



Image is not to scale

### FEATURES

- Polarized energy storage capacitor with high capacity and energy density
- Voltage flexibility: 1.4 V (single cell) to 2.8 V / 4.2 V / 5.6 V / 7.0 V / 8.4 V (multiple cells)
- Available in stacked through-hole (STH, radial), surface-mount flat (SMF) and lay flat configurations (LFC) with wire and connectors
- Useful life: up to 2000 h at 85 °C
- No cell balancing necessary
- Soft and low transient-voltage-controlled charging characteristic
- Non-hazardous electrolyte
- Maintenance-free, no service necessary
- Evaluation kits for engineering are available under ordering code: MAL219699001E3
- UL 810A recognized
- Material categorization: for definitions of compliance please see [www.vishay.com/doc?99912](http://www.vishay.com/doc?99912)



**RoHS**  
COMPLIANT

### APPLICATIONS

- Power backup for memory controller, flash backup, RAID systems, SRAM, DRAM
- Power failure and write cache protection for enterprise SSD and HDD
- Real time clock power source
- Burst power support for flash lights, wireless transmitters
- Backup power for industrial PC's and industrial controls
- Storage device for energy harvesting
- Emergency light and micro UPS power source

### MARKING

The capacitors are marked with the following information:

- Rated capacitance (in F)
- Rated voltage (in V)
- Date code
- Negative / positive terminal identification

### PACKAGING

Supplied in ESD trays only



QUICK REFERENCE DATA						
DESCRIPTION	VALUE					
	SINGLE CELL	2 CELLS	3 CELLS	4 CELLS	5 CELLS	6 CELLS
Nominal case size (Ø D x L in mm) Stacked Through-Hole (STH)	7 x 2.5 12 x 2.5 35 x 25 x 5	7 x 5 12 x 5 35 x 25 x 7.5	7 x 7.5 12 x 7.5 35 x 25 x 10	7 x 10 12 x 10 35 x 25 x 15	7 x 12.5 12 x 12.5 35 x 25 x 17.5	7 x 15 12 x 15 35 x 25 x 20
Nominal case size (Ø W x L x H in mm) Surface-Mount Flat (SMF)	7 x 7 x 2.5 12 x 12 x 2.5 -	7 x 14 x 2.5 12 x 24 x 2.5 -	13 x 14 x 2.5 22 x 24 x 2.5 -	14 x 14 x 2.5 24 x 24 x 2.5 -	-	-
Nominal case size (W x L x H in mm) Lay Flat (LFC)	14.5 x 12 x 2.5	14.5 x 24 x 2.5	14.5 x 36 x 2.5	14.5 x 48 x 2.5	14.5 x 60 x 2.5	14.5 x 72 x 2.5
Rated capacitance range, C <sub>R</sub>	4.0 F 15.0 F 90.0 F	4.0 F 15.0 F 90.0 F	4.0 F 15.0 F 90.0 F	4.0 F 15.0 F 90.0 F	4.0 F 15.0 F 90.0 F	4.0 F 15.0 F 90.0 F
Tolerance on C <sub>R</sub> at 20 °C	-20 % to +80 %					
Rated voltage, U <sub>R</sub>	1.4 V	2.8 V	4.2 V	5.6 V	7.0 V	8.4 V
Maximum surge voltage, U <sub>S</sub> (max. 30 s)	1.6 V	3.2 V	4.8 V	6.4 V	8.0 V	9.6 V
Minimum stored energy	4 Ws 17 Ws 115 Ws	9 Ws 35 Ws 230 Ws	13 Ws 52 Ws 345 Ws	18 Ws 70 Ws 460 Ws	22 Ws 87 Ws 575 Ws	27 Ws 105 Ws 690 Ws
Energy density	9 Ws/g to 13 Ws/g					
Category temperature range	4.0 F: -20 °C to +70 °C 15.0 F / 90.0 F: -20 °C to +85 °C					
Storage temperature range	-40 °C to +85 °C					
Useful life at U <sub>R</sub>	4.0 F		15.0 F		90.0 F	
	at 70 °C: 1000 h at 55 °C: 2800 h at 45 °C: 5600 h		at 85 °C: 1000 h at 70 °C: 2800 h at 60 °C: 5600 h		at 85 °C: 2000 h at 70 °C: 5600 h at 60 °C: 11 200 h	
Shelf life	1000 h at upper category temperature					
Climatic category IEC 60068	25 / 085 / 21					

SELECTION CHART FOR C <sub>R</sub> , U <sub>R</sub> , AND FORM AT UPPER CATEGORY TEMPERATURE (UCT)							
C <sub>R</sub> (F)	FORM	U <sub>R</sub> (V)					
		1.4	2.8	4.2	5.6	7.0	8.4
4	A2	7.0 x 2.5	7.0 x 5.0	7.0 x 7.5	7.0 x 10.0	7.0 x 12.5	7.0 x 15.0
	B2	7.0 x 2.5	7.0 x 5.0	7.0 x 7.5	7.0 x 10.0	7.0 x 12.5	7.0 x 15.0
	B3						
	C	7.0 x 7.0 x 2.5	-	-	-	-	-
	D	7.0 x 7.0 x 2.5	-	-	-	-	-
	E	-	7.0 x 14.0 x 2.5	13.0 x 14.0 x 2.5	14.0 x 14.0 x 2.5	-	-
15	A2	12.0 x 2.5	12.0 x 5.0	12.0 x 7.5	12.0 x 10.0	12.0 x 12.5	12.0 x 15.0
	B2	12.0 x 2.5	12.0 x 5.0	12.0 x 7.5	12.0 x 10.0	12.0 x 12.5	12.0 x 15.0
	B3						
	C	12.0 x 12.0 x 2.5	-	-	-	-	-
	D	12.0 x 12.0 x 2.5	-	-	-	-	-
	E	-	12.0 x 24.0 x 2.5	22.0 x 24.0 x 2.5	24.0 x 24.0 x 2.5	-	-
	F	14.5 x 12.0 x 2.5	14.5 x 24.0 x 2.5	14.5 x 36.0 x 2.5	14.5 x 48.0 x 2.5	14.5 x 60.0 x 2.5	14.5 x 72.0 x 2.5
90	G	35 x 25 x 5	35 x 25 x 7.5	35 x 25 x 10	35 x 25 x 15	35 x 25 x 17.5	35 x 25 x 20
	H						

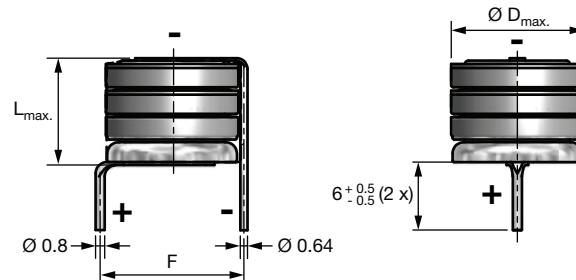
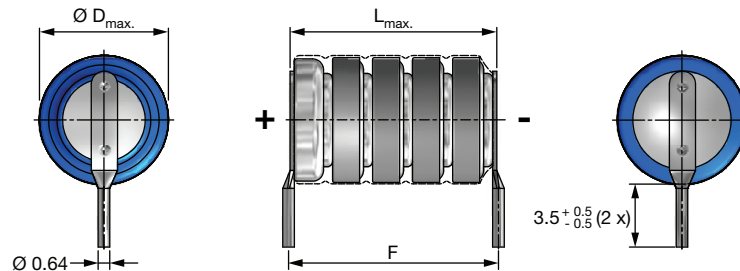
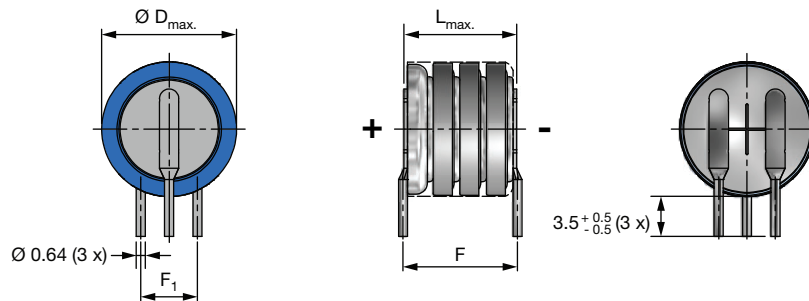
**DIMENSIONS** in millimeters **AND AVAILABLE FORMS**
**STACKED THROUGH HOLE CONFIGURATION (STH): Examples VERTICAL MOUNT**

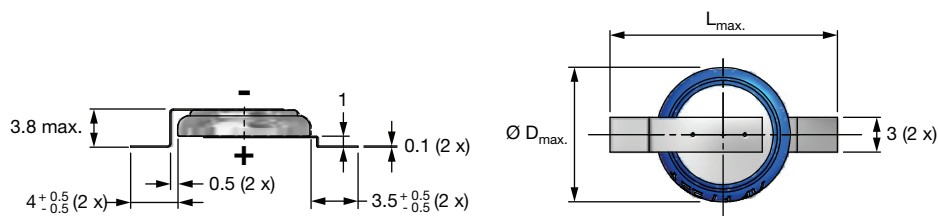
 Fig. 1 - **Form A2:** Stacked Through Hole (example 4 cells, 2 pins) <sup>(1)</sup>
**STACKED THROUGH HOLE CONFIGURATION (STH): Examples HORIZONTAL MOUNT**

 Fig. 2 - **Form B2:** Stacked Through Hole (example 5 cells, 2 pins) <sup>(1)</sup>

 Fig. 3 - **Form B3:** Stacked Through Hole (example 4 cells, keyed polarity - 3 pins) <sup>(1)</sup>
**Note**
<sup>(1)</sup> Bottom and top are not isolated

**SURFACE MOUNT FLAT CONFIGURATION (SMF): Examples**

 Fig. 4 - **Form C:** Surface Mount Flat (single cell, keyed polarity)

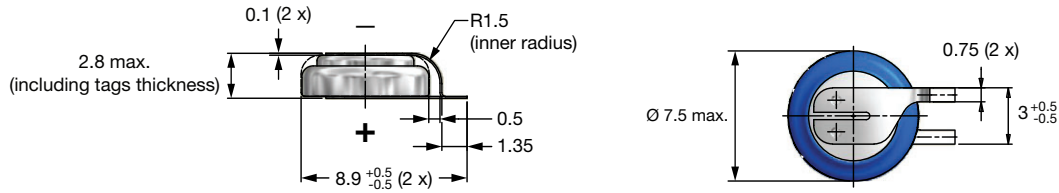

Fig. 5 - **Form D1:** Surface Mount Flat (single cell, keyed polarity)



Fig. 6 - **Form D2:** Surface Mount Flat (single cell, keyed polarity)

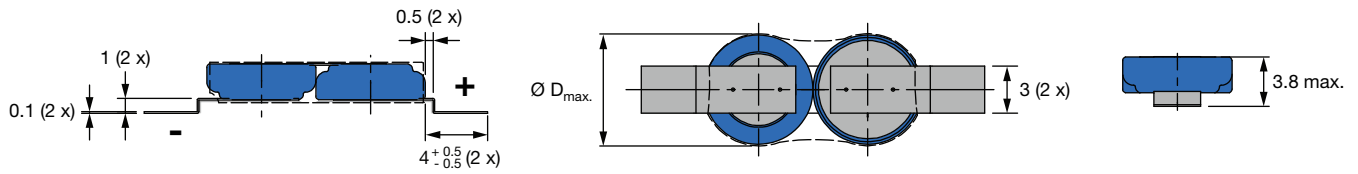

Fig. 7 - **Form E2:** Surface Mount Flat

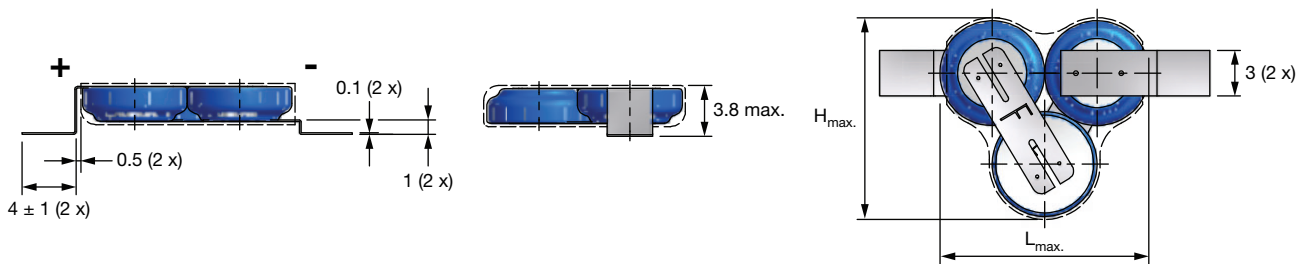

Fig. 8 - **Form E3:** Surface Mount Flat

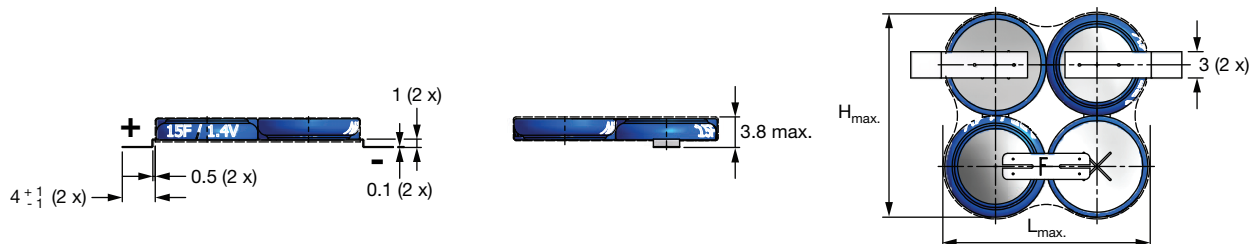

Fig. 9 - **Form E4:** Surface Mount Flat

LAY FLAT CONFIGURATION (LFC) WITH CONNECTOR: Example 5 cells in series

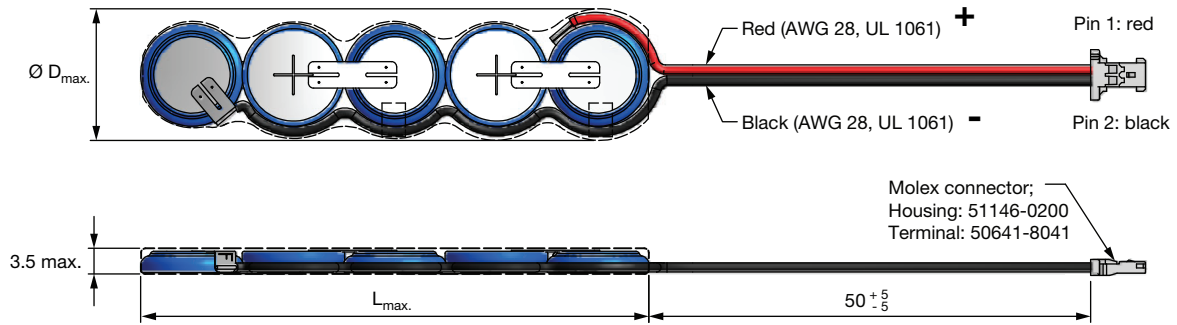

Fig. 10 - Form F: Lay Flat (example for 5 cells)

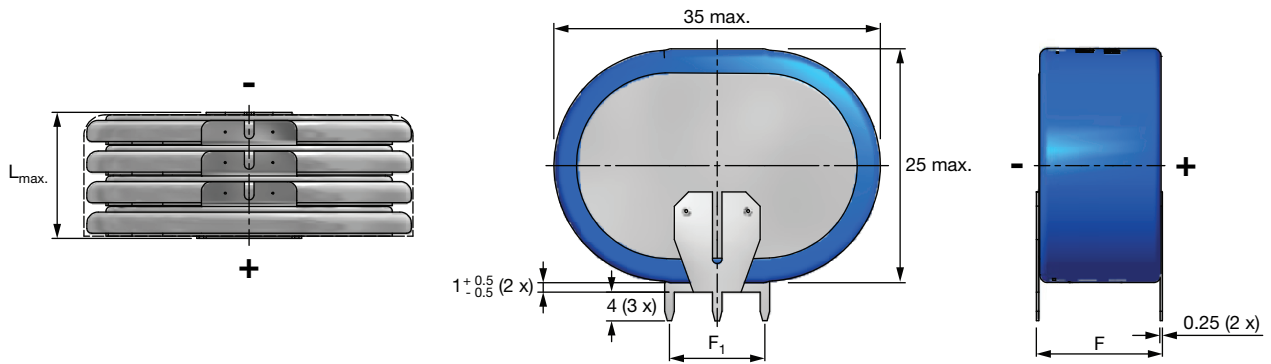

Fig. 11 - Form G: Stacked Through Hole Oval (PCBD)

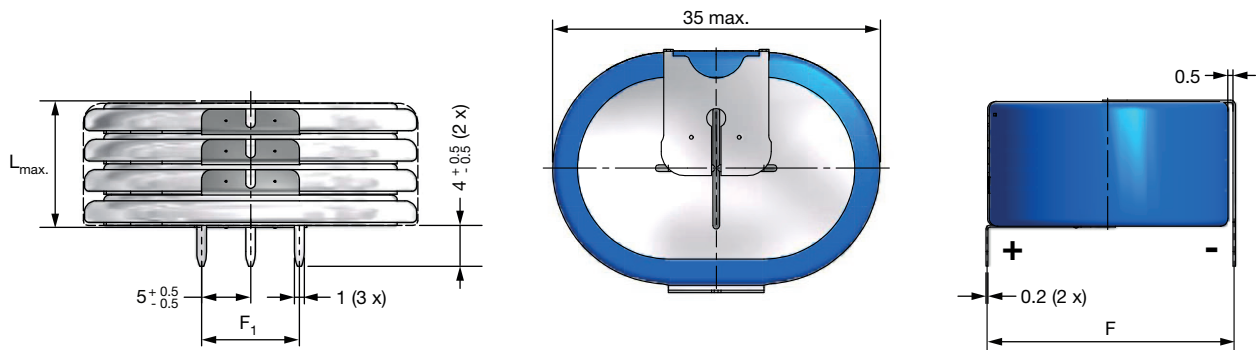

Fig. 12 - Form H: Stacked Through Hole Oval Horizontal



Table 1

<b>DIMENSIONS</b> in millimeters, <b>MASS AND PACKAGING QUANTITIES</b>						
<b>NOMINAL CASE SIZE D x L x H (mm)</b>	<b>FORM</b>	<b>Ø D<sub>max.</sub></b>	<b>L<sub>max.</sub></b>	<b>L1<sub>max.</sub> (1)</b>	<b>H<sub>max.</sub></b>	<b>MASS (g)</b>
7.0 x 7.0 x 2.5	A2, B2, B3	7.5	2.6	2.6 ± 0.5	-	0.5
7.0 x 7.0 x 2.5	C	7.5	7.0	7.0 + 8.0	-	0.5
7.0 x 7.0 x 2.5	D1	7.5	7.0	7.0 + 4.0	-	0.5
7.0 x 7.0 x 5.0	A2, B2, B3	7.5	5.0	5.0 ± 0.5	-	0.8
7.0 x 7.0 x 7.5	A2, B2, B3	7.5	7.5	7.5 ± 0.5	-	1.5
7.0 x 7.0 x 10.0	A2, B2, B3	7.5	10.0	10.0 ± 0.5	-	1.8
7.0 x 7.0 x 12.5	A2, B2, B3	7.5	12.0	12.0 ± 0.5	-	2.5
7.0 x 7.0 x 15.0	A2, B2, B3	7.5	16.0	16.0 ± 0.5	-	3.0
12.0 x 12.0 x 2.5	A2, B2, B3	12.5	2.8	2.8 ± 0.5	-	1.2
12.0 x 12.0 x 2.5	C	12.5	12.5	12.5 + 8.0	-	1.0
12.0 x 12.0 x 2.5	D2	12.5	12.5	12.5 + 4.0	-	1.0
12.0 x 12.0 x 5.0	A2, B2, B3	12.5	5.0	5.0 ± 0.5	-	2.2
12.0 x 12.0 x 7.5	A2, B2, B3	12.5	7.5	7.5 ± 0.5	-	3.3
12.0 x 12.0 x 10.0	A2, B2, B3	12.5	10.0	10.0 ± 0.5	-	4.0
12.0 x 12.0 x 12.5	A2, B2, B3	12.5	12.5	12.5 ± 0.5	-	5.4
12.0 x 12.0 x 15.0	A2, B2, B3	12.5	15.0	15.0 ± 0.5	-	6.5
7.0 x 14.0 x 2.5	E2	7.5	15.0	15.0 + 10.0	-	1.0
12.0 x 24.0 x 2.5	E2	12.5	24.0	24.0 + 10.0	-	2.0
13.0 x 14.0 x 2.5	E3	14.0	15.0	15.0 + 10.0	14.0	1.2
22.0 x 24.0 x 2.5	E3	24.0	24.0	24.0 + 10.0	22.5	3.3
14.0 x 14.0 x 2.5	E4	15.0	15.0	15.0 + 10.0	15.0	1.5
24.0 x 24.0 x 2.5	E4	24.0	24.0	24.0 + 10.0	24.0	4.4
14.5 x 12.0 x 2.5	F	14.5	12.0	12.0 + 50.0	-	1.0
14.5 x 24.0 x 2.5	F	14.5	24.0	24.0 + 50.0	-	3.0
14.5 x 36.0 x 2.5	F	14.5	36.0	36.0 + 50.0	-	4.0
14.5 x 48.0 x 2.5	F	14.5	48.0	48.0 + 50.0	-	6.0
14.5 x 60.0 x 2.5	F	14.5	60.0	60.0 + 50.0	-	7.5
14.5 x 72.0 x 2.5	F	14.5	72.0	72.0 + 50.0	-	9.0
35 x 25 x 5.0	G, H	35 x 25	3.6	3.6 ± 1.0	-	7.5
35 x 25 x 7.5	G, H	35 x 25	6.8	6.8 ± 1.0	-	15.0
35 x 25 x 10.0	G, H	35 x 25	10.0	10.0 ± 1.0	-	22.5
35 x 25 x 15.0	G, H	35 x 25	13.0	13.0 ± 1.0	-	30.0
35 x 25 x 17.5	G, H	35 x 25	16.8	16.8 ± 1.0	-	45.0
35 x 25 x 20.0	G, H	35 x 25	20.1	20.1 ± 1.0	-	50.0

**Note**(1) L1<sub>max.</sub> includes tags



ELECTRICAL DATA	
SYMBOL	DESCRIPTION
C <sub>R</sub>	Rated capacitance, tolerance -20 % / +80 %, measured by constant current discharge method
UCT	Upper category temperature
I <sub>L</sub>	Max. leakage current after 24 h at U <sub>R</sub>
R <sub>i</sub>	Max. internal resistance at 1 kHz

**ORDERING EXAMPLE**

Hybrid Storage Capacitor

15 F / 1.4 V

Nominal case size: Ø 12.0 mm x 2.5 mm; Form B3

Ordering code: MAL219691211E3

**Note**

- Unless otherwise specified, all electrical values in Table 2 apply at T<sub>amb</sub> = 20 °C, P = 86 kPa to 106 kPa and RH = 45 % to 75 %

Table 2

ELECTRICAL DATA AND ORDERING INFORMATION													
U <sub>R</sub> (V)	C <sub>R</sub> (F)	NOMINAL CASE SIZE Ø D x L D x L x H (mm)	CASE CODE	FORM	F (mm)	F1 (mm)	UCT (°C)	I <sub>L</sub> 24 h (mA)	ESR AC <sup>(1)</sup> 1 kHz (Ω)	ESR DC <sup>(2)</sup> (Ω)	MIN. STORAGE ENERGY (Ws)	PACKAGING QUANTITIES	ORDERING CODE
<b>STACKED THROUGH HOLE CONFIGURATION (STH) - VERTICAL MOUNT</b>													
1.4	4	7.0 x 2.5	2 pin	A2	7.5	-	70	0.03	2.5	7.5	4.6	80	MAL219691101E3
2.8	4	7.0 x 5.0	2 pin	A2	7.5	-	70	0.03	5.0	15.0	9.2	80	MAL219691102E3
4.2	4	7.0 x 7.5	2 pin	A2	7.5	-	70	0.03	7.5	22.5	13.8	80	MAL219691103E3
5.6	4	7.0 x 10.0	2 pin	A2	7.5	-	70	0.03	10.0	30.0	18.4	80	MAL219691104E3
7.0	4	7.0 x 12.5	2 pin	A2	7.5	-	70	0.03	12.5	37.5	23.0	84	MAL219691105E3
8.4	4	7.0 x 15.0	2 pin	A2	7.5	-	70	0.03	15.0	45.0	27.6	84	MAL219691106E3
1.4	15	12.0 x 2.5	2 pin	A2	12.5	-	85	0.12	0.6	2.5	17.5	80	MAL219691201E3
2.8	15	12.0 x 5.0	2 pin	A2	12.5	-	85	0.12	1.2	5.0	35.0	80	MAL219691202E3
4.2	15	12.0 x 7.5	2 pin	A2	12.5	-	85	0.12	1.8	7.5	52.5	80	MAL219691203E3
5.6	15	12.0 x 10.0	2 pin	A2	12.5	-	85	0.12	2.4	10.0	70.0	80	MAL219691204E3
7.0	15	12.0 x 12.5	2 pin	A2	12.5	-	85	0.12	3.0	12.5	87.5	90	MAL219691205E3
8.4	15	12.0 x 15.0	2 pin	A2	12.5	-	85	0.12	3.6	15.0	105.0	90	MAL219691206E3
<b>STACKED THROUGH HOLE CONFIGURATION (STH) - HORIZONTAL MOUNT</b>													
1.4	4	7.0 x 2.5	2 pin	B2	3.2	-	70	0.03	2.5	7.5	4.6	100	MAL219691121E3
2.8	4	7.0 x 5.0	2 pin	B2	5.4	-	70	0.03	5.0	15.0	9.2	100	MAL219691122E3
4.2	4	7.0 x 7.5	2 pin	B2	7.5	-	70	0.03	7.5	22.5	13.8	96	MAL219691123E3
5.6	4	7.0 x 10.0	2 pin	B2	8.8	-	70	0.03	10.0	30.0	18.4	96	MAL219691124E3
7.0	4	7.0 x 12.5	2 pin	B2	12	-	70	0.03	12.5	37.5	23.0	60	MAL219691125E3
8.4	4	7.0 x 15.0	2 pin	B2	14.5	-	70	0.03	15.0	45.0	27.6	60	MAL219691126E3
1.4	15	12.0 x 2.5	2 pin	B2	3.2	-	85	0.12	0.6	2.5	17.5	100	MAL219691221E3
2.8	15	12.0 x 5.0	2 pin	B2	5.8	-	85	0.12	1.2	5.0	35.0	100	MAL219691222E3
4.2	15	12.0 x 7.5	2 pin	B2	8.3	-	85	0.12	1.8	7.5	52.5	80	MAL219691223E3
5.6	15	12.0 x 10.0	2 pin	B2	11.0	-	85	0.12	2.4	10.0	70.0	90	MAL219691224E3
7.0	15	12.0 x 12.5	2 pin	B2	13.4	-	85	0.12	3.0	12.5	87.5	40	MAL219691225E3
8.4	15	12.0 x 15.0	2 pin	B2	15.7	-	85	0.12	3.6	15.0	105.0	40	MAL219691226E3
1.4	4	7.0 x 2.5	3 pin	B3	2.8	2.5	70	0.03	2.5	7.5	4.6	100	MAL219691111E3
2.8	4	7.0 x 5.0	3 pin	B3	5.1	2.5	70	0.03	5.0	15.0	9.2	100	MAL219691112E3
4.2	4	7.0 x 7.5	3 pin	B3	7.5	2.5	70	0.03	7.5	22.5	13.8	96	MAL219691113E3
5.6	4	7.0 x 10.0	3 pin	B3	10.0	2.5	70	0.03	10.0	30.0	18.4	96	MAL219691114E3
7.0	4	7.0 x 12.5	3 pin	B3	12.0	2.5	70	0.03	12.5	37.5	23.0	60	MAL219691115E3
8.4	4	7.0 x 15.0	3 pin	B3	14.5	2.5	70	0.03	15.0	45.0	27.6	60	MAL219691116E3
1.4	15	12.0 x 2.5	3 pin	B3	3.2	5.0	85	0.12	0.6	2.5	17.5	100	MAL219691211E3
2.8	15	12.0 x 5.0	3 pin	B3	5.8	5.0	85	0.12	1.2	5.0	35.0	100	MAL219691212E3
4.2	15	12.0 x 7.5	3 pin	B3	8.0	5.0	85	0.12	1.8	7.5	52.5	80	MAL219691213E3
5.6	15	12.0 x 10.0	3 pin	B3	11.0	5.0	85	0.12	2.4	10.0	70.0	90	MAL219691214E3
7.0	15	12.0 x 12.5	3 pin	B3	13.0	5.0	85	0.12	3.0	12.5	87.5	40	MAL219691215E3
8.4	15	12.0 x 15.0	3 pin	B3	16.0	5.0	85	0.12	3.6	15.0	105.0	40	MAL219691216E3



ELECTRICAL DATA AND ORDERING INFORMATION													
U <sub>R</sub> (V)	C <sub>R</sub> (F)	NOMINAL CASE SIZE Ø D x L D x L x H (mm)	CASE CODE	FORM	F (mm)	F1 (mm)	UCT (°C)	I <sub>L</sub> 24 h (mA)	ESR AC <sup>(1)</sup> 1 kHz (Ω)	ESR DC <sup>(2)</sup> (Ω)	MIN. STORAGE ENERGY (Ws)	PACKAGING QUANTITIES	ORDERING CODE
<b>SURFACE MOUNT FLAT CONFIGURATION (SMF)</b>													
1.4	4	7.0 x 7.0 x 2.5	2 pin	C	-	-	70	0.03	2.5	7.5	4.6	50	MAL219691131E3
1.4	15	12.0 x 12.0 x 2.5	2 pin	C	-	-	85	0.12	0.6	2.5	17.5	100	MAL219691231E3
1.4	4	7.0 x 7.0 x 2.5	2 pin	D1	-	-	70	0.03	2.5	7.5	4.6	50	MAL219691141E3
1.4	15	12.0 x 12.0 x 2.5	2 pin	D2	-	-	85	0.12	0.6	2.5	17.5	100	MAL219691241E3
2.8	4	7.0 x 14.0 x 2.5	2 pin	E2	-	-	70	0.03	5.0	15.0	9.2	50	MAL219691152E3
2.8	15	12.0 x 24.0 x 2.5	2 pin	E2	-	-	85	0.12	1.2	5.0	35.0	50	MAL219691252E3
4.2	4	13.0 x 14.0 x 2.5	2 pin	E3	-	-	70	0.03	7.5	22.5	13.8	70	MAL219691153E3
4.2	15	22.0 x 24.0 x 2.5	2 pin	E3	-	-	85	0.12	1.8	7.5	52.5	35	MAL219691253E3
5.6	4	14.0 x 14.0 x 2.5	2 pin	E4	-	-	70	0.03	10.0	30.0	18.4	70	MAL219691154E3
5.6	15	24.0 x 24.0 x 2.5	2 pin	E4	-	-	85	0.12	2.4	10.0	70.0	35	MAL219691254E3
<b>LAY FLAT CONFIGURATION (LFC)</b>													
1.4	15	14.5 x 12.0 x 2.5	2 pin	F	-	-	85	0.12	0.6	2.5	17.5	40	MAL219691261E3
2.8	15	14.5 x 24.0 x 2.5	2 pin	F	-	-	85	0.12	1.2	5.0	35.0	40	MAL219691262E3
4.2	15	14.5 x 36.0 x 2.5	2 pin	F	-	-	85	0.12	1.8	7.5	52.5	40	MAL219691263E3
5.6	15	14.5 x 48.0 x 2.5	2 pin	F	-	-	85	0.12	2.4	10.0	70.0	20	MAL219691264E3
7.0	15	14.5 x 60.0 x 2.5	2 pin	F	-	-	85	0.12	3.0	12.5	87.5	20	MAL219691265E3
8.4	15	14.5 x 72.0 x 2.5	2 pin	F	-	-	85	0.12	3.6	15.0	105.0	20	MAL219691266E3
<b>STACKED THROUGH HOLE OVAL</b>													
1.4	90	35 x 25 x 5.0	3 pin	G	5	10	85	0.5	0.015	0.045	115.0	25	MAL219690106E3
2.8	90	35 x 25 x 7.5	3 pin	G	7.5	10	85	0.5	0.03	0.090	230.0	25	MAL219690103E3
4.2	90	35 x 25 x 10.0	3 pin	G	10	10	85	0.5	0.04	0.135	345.0	25	MAL219690101E3
5.6	90	35 x 25 x 15.0	3 pin	G	12.5	10	85	0.5	0.06	0.180	460.0	25	MAL219690102E3
7.0	90	35 x 25 x 17.5	3 pin	G	17.5	10	85	0.5	0.075	0.225	575.0	25	MAL219690107E3
8.4	90	35 x 25 x 20.0	3 pin	G	20.0	10	85	0.5	0.09	0.270	690.0	25	MAL219690108E3
<b>STACKED THROUGH HOLE OVAL HORIZONTAL</b>													
1.4	90	35 x 25 x 5.0	3 pin	H	25	10	85	0.5	0.015	0.045	115.0	25	MAL219690116E3
2.8	90	35 x 25 x 7.5	3 pin	H	25	10	85	0.5	0.03	0.090	230.0	25	MAL219690113E3
4.2	90	35 x 25 x 10.0	3 pin	H	25	10	85	0.5	0.04	0.135	345.0	25	MAL219690111E3
5.6	90	35 x 25 x 15.0	3 pin	H	25	10	85	0.5	0.06	0.180	460.0	25	MAL219690112E3
7.0	90	35 x 25 x 17.5	3 pin	H	25	10	85	0.5	0.075	0.225	575.0	25	MAL219690117E3
8.4	90	35 x 25 x 20.0	3 pin	H	25	10	85	0.5	0.09	0.270	690.0	25	MAL219690118E3

**Notes**

- (1) ESR AC 1 kHz are typical values
- (2) ESR DC are typical values

**Table 3**

LOAD CURRENTS AND VOLTAGES				
C <sub>R</sub> (F)	RECOMMENDED CHARGE CURRENT	MAX. CHARGE CURRENT	MAX. DISCHARGE CURRENT	LOWEST DISCHARGE VOLTAGE <sup>(1)</sup>
4	2 mA to 8 mA	14 mA	25 mA	n x 0.8 V
15	5 mA to 20 mA	50 mA	70 mA	n x 0.8 V
90	0.3 A to 1 A	1.5 A	3 A	n x 0.8 V

**Note**

- (1) n... number of cells, permanent operation below lowest discharge voltage is not permitted

**MEASURING OF CHARACTERISTICS**

**CAPACITANCE (C)**

Capacitance shall be measured by constant current discharge method.

DISCHARGE CURRENT AS A FUNCTION OF RATED CAPACITANCE				
PARAMETER	VALUE			UNIT
Rated capacitance, C <sub>R</sub>	4	15	90	F
Discharge current, I <sub>D</sub>	4	15	90	mA

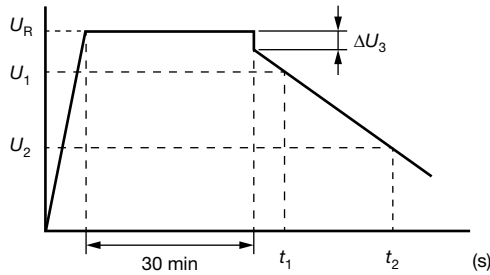

Fig. 13 - Voltage Diagram for Capacitance Measurement

Capacitance value C<sub>R</sub> is given by discharge current I<sub>D</sub>, time t and rated voltage U<sub>R</sub>, according to the following equation:

- C<sub>R</sub> Rated capacitance, in F
- U<sub>R</sub> Rated voltage, in V
- U<sub>1</sub> Starting voltage, in V
- U<sub>2</sub> Ending voltage, in V
- ΔU<sub>3</sub> Voltage drop at internal resistance, in V
- t<sub>1</sub> Time from start of discharge until voltage U<sub>1</sub> is reached, in s
- t<sub>2</sub> Time from start of discharge until voltage U<sub>2</sub> is reached, in s
- I<sub>D</sub> Discharge current, in A

$$C_R(F) = \frac{I_D(A) \times (t_2(s) - t_1(s))}{U_1(V) - U_2(V)}$$

For I<sub>D</sub>, U<sub>1</sub>, and U<sub>2</sub> the following definitions have to be used:

**Table 4**

CAPACITANCE						
C (F)	I <sub>D</sub> (A)	U <sub>R</sub> (V)	U <sub>1</sub> (V)	U <sub>2</sub> (V)	t <sub>1</sub> (s)	t <sub>2</sub> (s)
4	0.004	1.4	1.3	0.7	5	> 600
4	0.004	2.8	2.7	1.9	5	> 600
4	0.004	4.2	4.0	3.1	5	> 600
4	0.004	5.6	5.4	4.4	5	> 600
4	0.004	7.0	6.7	5.6	5	> 600
4	0.004	8.4	8.1	6.9	5	> 600
15	0.015	1.4	1.3	0.7	5	> 600
15	0.015	2.8	2.7	1.9	5	> 600
15	0.015	4.2	4.0	3.1	5	> 600
15	0.015	5.6	5.4	4.4	5	> 600
15	0.015	7.0	6.7	5.6	5	> 600
15	0.015	8.4	8.1	6.9	5	> 600

CAPACITANCE						
C (F)	I <sub>D</sub> (A)	U <sub>R</sub> (V)	U <sub>1</sub> (V)	U <sub>2</sub> (V)	t <sub>1</sub> (s)	t <sub>2</sub> (s)
90	0.090	1.4	1.3	0.7	5	> 600
90	0.090	2.8	2.7	1.9	5	> 600
90	0.090	4.2	4.0	3.1	5	> 600
90	0.090	5.6	5.4	4.4	5	> 600
90	0.090	7.0	6.7	5.6	5	> 600
90	0.090	8.4	8.1	6.9	5	> 600

**Note**

- For U<sub>2</sub> see also Table 5

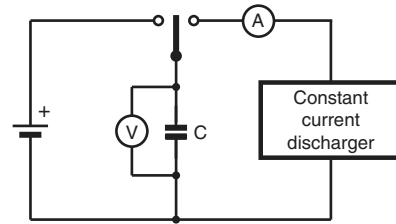

Fig. 14 - Test Circuit for Capacitance Measurement

**INTERNAL RESISTANCE (R<sub>I</sub>) AT 1 kHz**

$$R_I(\Omega) = \frac{U_C(V)}{10^{-3}}$$

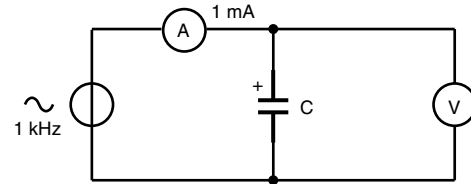

Fig. 15 - Test Circuit for R<sub>I</sub> Measurement

**LEAKAGE CURRENT (I<sub>L</sub>)**

Leakage current shall be measured after 30 min application of rated voltage U<sub>R</sub>:

$$I_L(\mu A) = \frac{U_S(V)}{10^{-4}}$$

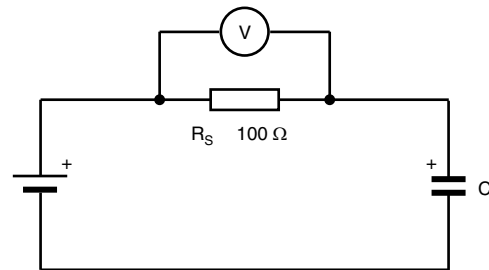

Fig. 16 - Test Circuit for Leakage Current

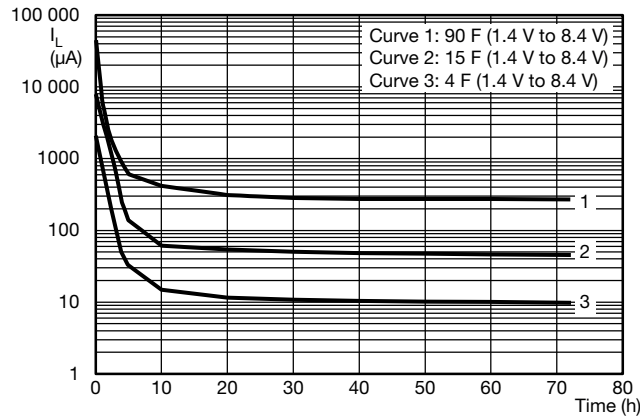

Fig. 17 - Typical Leakage Current at 20 °C as a Function of Time

**Table 5**

VOLTAGE TO BE USED FOR SERIES CONNECTION			
N CELLS IN SERIES	$U_R$ (V)	$U_1$ (V)	$U_2$ (V)
1	1.4	1.3	0.7
2	2.8	2.7	1.9
3	4.2	4.0	3.1
4	5.6	5.4	4.4
5	7.0	6.7	5.6
6	8.4	8.1	6.9

### DISCHARGE CHARACTERISTICS

Backup time of 196 HVC series capacitors depends on minimum memory holding voltage and discharge current (corresponding with the current consumption of the load).

For minimum backup times of standard and vertical miniaturized series see Fig. 18 to Fig. 20 (charging time  $\geq 24$  h and CC-CV charging according to table 3).

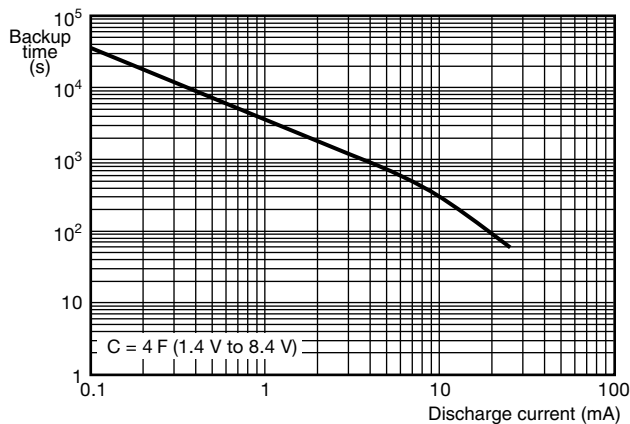

Fig. 18 - Typical Backup Time as a Function of Discharge Current

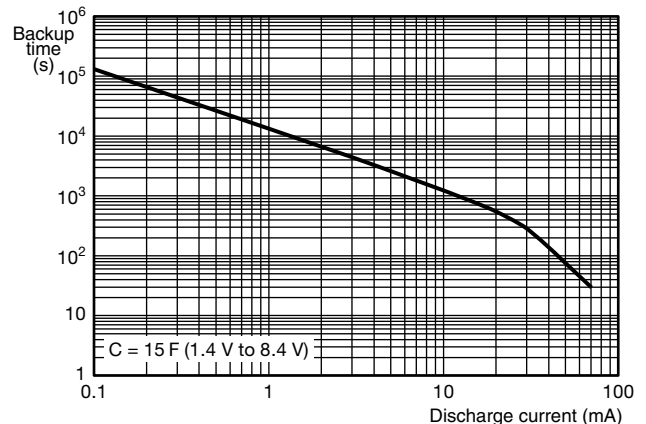

Fig. 19 - Typical Backup Time as a Function of Discharge Current

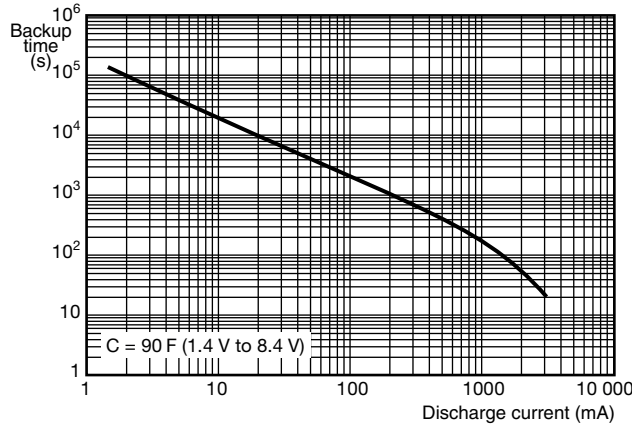

Fig. 20 - Typical Backup Time as a Function of Discharge Current

**CHARGE CHARACTERISTICS**

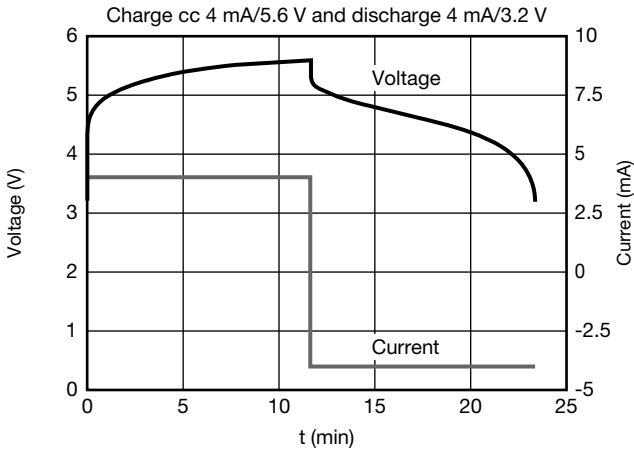

Fig. 21 - Constant Current (CC) with V-Limit Charging Method at RT  
Typical Charge / Discharge Characteristics at RT: 4 F / 5.6 V

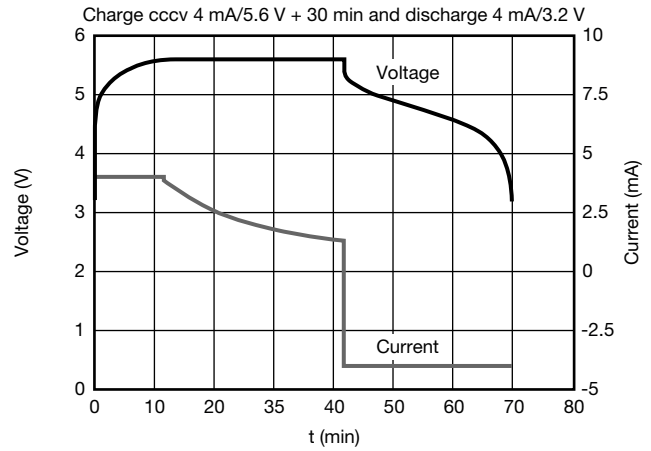

Fig. 22 - Constant Current (CC)-Constant Voltage (CV)  
Charging Method at RT  
Typical Charge / Discharge Characteristics at RT: 4 F / 5.6 V

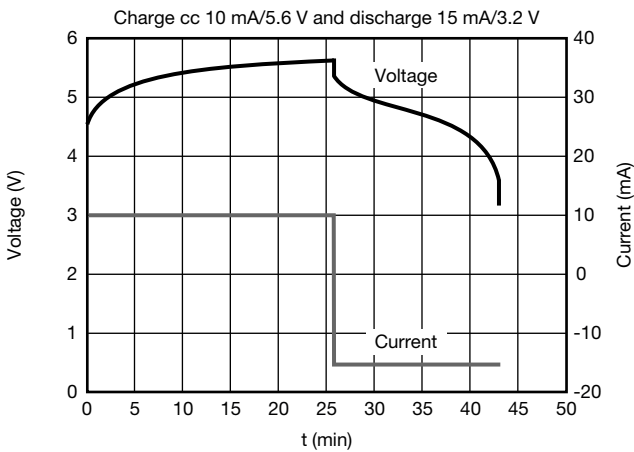

Fig. 23 - Constant Current (CC) with V-Limit Charging Method at RT  
Typical Charge / Discharge Characteristics at RT: 15 F / 5.6 V

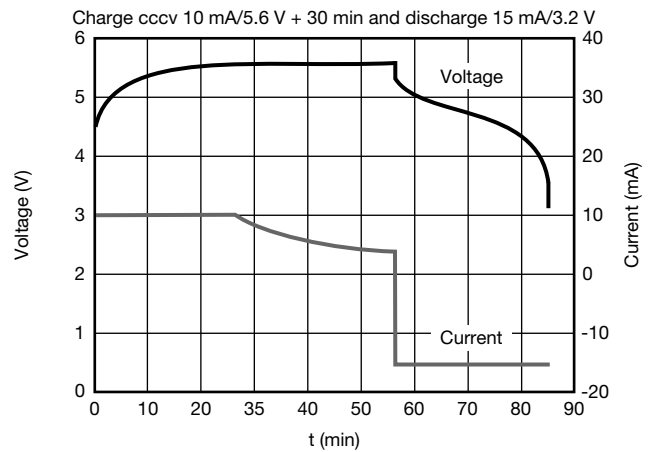
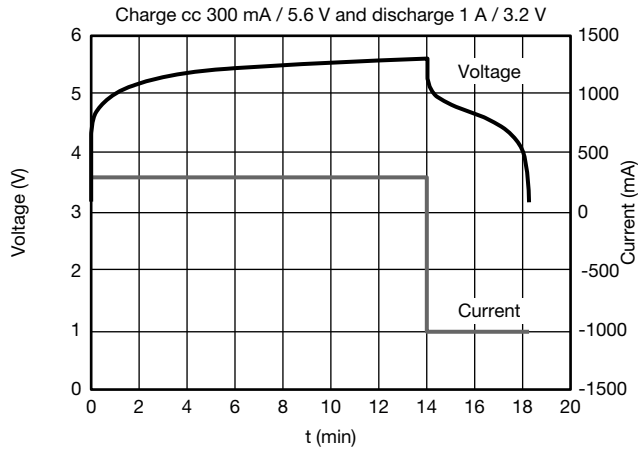
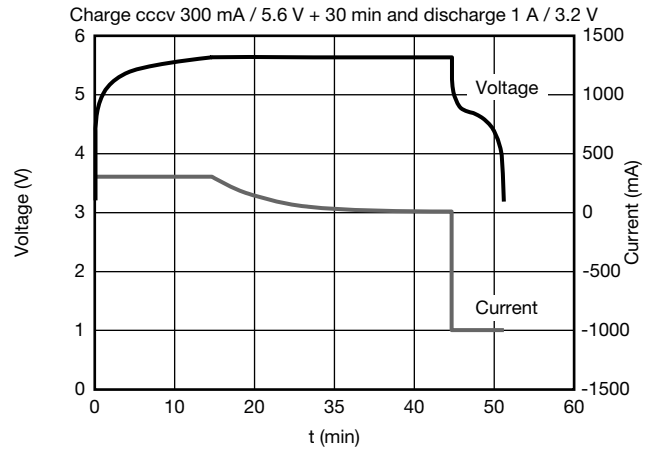

Fig. 24 - Constant Current (CC)-Constant Voltage (CV)  
Charging Method at RT  
Typical Charge / Discharge Characteristics at RT: 15 F / 5.6 V

**Note**

- Charge and discharge cycles at room temperature (RT) - maximal 50 000 cycles at room temperature allowed!

 Fig. 25 - Constant Current (CC) with V-Limit Charging Method at RT  
 Typical Charge / Discharge Characteristics at RT: 90 F / 5.6 V

 Fig. 26 - Constant Current (CC)-Constant Voltage (CV)  
 Charging Method at RT  
 Typical Charge / Discharge Characteristics at RT: 90 F / 5.6 V

**Note**

- Charge and discharge cycles at room temperature (RT) - maximal 50 000 cycles at room temperature allowed!

<b>CHARGING VOLTAGE AT DIFFERENT TEMPERATURES</b>			
<b>OPERATING TEMPERATURE RANGE</b>	<b>0 °C UP TO +45 °C</b>		<b>+45 °C UP TO +60 °C</b>
Charge voltage	1 cell	$U_R + 0.03 \text{ V}$	$U_R$
	2 cells	$U_R + 0.06 \text{ V}$	
	3 cells	$U_R + 0.09 \text{ V}$	
	> 4 cells	$U_R + 0.10 \text{ V}$	
			$U_R - n^{(1)} \times 0.0015 \times (T[^\circ\text{C}] - 45)$

**Notes**

- Capacitor is polarized, product will be damaged if reverse charged
  - Voltages higher than specified need to be avoided; otherwise reduction of life time, internal gas generation or damage of HVC hybrid capacitor will occur
  - For other operating temperatures, a temperature derating factor has to be considered for correct charging voltage
  - Surge voltage is only allowed a few seconds per day, but not as a charging process
- (1) n... number of cells

**DERATING**

Working voltage at temperatures above 60 °C should be below rated voltage  $U_R$ . A derating-factor of -1.5 mV/°C per cell is recommended.

**PRODUCT AND MOUNTING CHARACTERISTICS**

**Attention: parts are pre-charged at delivery - handle appropriate.**

At delivery products are pre-charged and voltage over terminals is near nominal voltage. Short circuiting of product terminals is permitted. Do not short circuit permanently. Short circuiting of charged cells may heat up the cells.

For printed circuit board mounting it has to be taken into account, that for certain form factors top and bottom of products may not be insulated.

Capacitor disposal methods should be in accordance with local and state regulations.

**Table 6.1**

<b>TEST PROCEDURES AND REQUIREMENTS</b>			
<b>NAME OF TEST</b>	<b>ENYCAP TESTS SUBCLAUSE</b>	<b>PROCEDURE (quick reference)</b>	<b>REQUIREMENTS <sup>(2)</sup></b>
Damp heat, steady state	4.12	500 h at 55 °C; RH 90 % to 95 %; no voltage applied	$\Delta C/C: \pm 30 \%$ $R_I \leq 4 \times \text{spec. limit}$ $I_L \leq 2 \times \text{spec. limit}$
Endurance	4.13.1	$T_{\text{amb}} = 70 \text{ °C} / 85 \text{ °C}$ ; rated voltage $U_R$ applied; 4.0 F, 15 F: 1000 h 90 F: 2000 h	$\Delta C/C: \pm 30 \%$ $R_I \leq 4 \times \text{spec. limit}$ $I_L \leq 2 \times \text{spec. limit}$
Useful life	4.13.2	$T_{\text{amb}} = 70 \text{ °C} / 85 \text{ °C}$ ; rated voltage $U_R$ applied; 4.0 F, 15 F: 1000 h 90 F: 2000 h	$\Delta C/C: \pm 30 \%$ $R_I \leq 4 \times \text{spec. limit}$ $I_L \leq 2 \times \text{spec. limit}$
Storage at upper category temperature	4.17	$T_{\text{amb}} = 70 \text{ °C} / 85 \text{ °C}$ ; no voltage applied; 1000 h	$\Delta C/C: \pm 30 \%$ $R_I \leq 4 \times \text{spec. limit}$ $I_L \leq 2 \times \text{spec. limit}$
Self discharge	4.1.5	24 h storage at room temperature after application of $U_R$ for 1 h	Remaining voltage: $\geq (U_R \times 0.9)$
Characteristics at high and low temperature	4.19	Step 1: reference measurement at 20 °C of C, $R_I$ , and $I_L$ Step 2: measurement at -20 °C Step 3: measurement at +20 °C Step 4: measurement at +70 °C Step 5: measurement at +20 °C	$\Delta C/C: \pm 30 \%$ of +20 °C value $R_I \leq 5 \times \text{the } +20 \text{ °C value}$ $I_L \leq 4 \times \text{the } +20 \text{ °C value}$
Surge voltage	4.15	Max. 30 s at room temperature $U_S = n^{(1)} \times 1.6 \text{ V}$	No change of parameter! After surge voltage, discharge product below rated voltage

**Notes**

- (1) n... number of cells  
(2)  $R_I$  equals  $ESR_{AC}$  or  $ESR_{DC}$

**Table 6.2: Stacked Through Hole configuration (STH), Surface Mount Flat configuration (SMF), and Lay Flat configuration with Connector**

<b>TEST PROCEDURES AND REQUIREMENTS</b>			
<b>NAME OF TEST</b>	<b>ENYCAP TESTS SUBCLAUSE</b>	<b>PROCEDURE (quick reference)</b>	<b>REQUIREMENTS <sup>(1)</sup></b>
Robustness of terminations	4.4	Tensile strength; application of load force in pin / tab direction for 10 s: 10 N: for product size $\varnothing \geq 8 \text{ mm}$ 5 N: for product size $\varnothing < 8 \text{ mm}$	No breaks
Resistance to soldering heat	4.5	260 °C; 5 s	$\Delta C/C: \pm 10 \%$ $R_I$ and $I_L \leq \text{spec. limit}$
Solderability	4.6	Solder bath; 236 °C; 2 s; one pin immersed	$\geq 75 \%$ tinning
Vibration	4.8	10 Hz to 55 Hz; 1.5 mm; 3 directions; 2 h per direction	$\Delta C/C: \pm 10 \%$ $R_I$ and $I_L \leq \text{spec. limit}$

**Notes**

- Robustness - bending limited to  $\pm 15^\circ$ , force in direction of tab / pin, no twisting allowed
  - Solder bath test: max. allowed case temperature during test is e.g. 85 °C or immersion of one (1) pad only
  - Wave soldering allowed
- (1)  $R_I$  equals  $ESR_{AC}$  or  $ESR_{DC}$

**SOLDERING**

As a general principle, temperature and duration shall be the minimum necessary required to ensure good soldering connections. However, the maximum specified soldering time and case temperature should never be exceeded.

**EVALUATION KIT**

Evaluation kits are available under ordering code: MAL219699001E3. The engineering kit includes a charge and discharge demo board with different 196 HVC capacitor samples.

For further details, please contact [hybridstorage@vishay.com](mailto:hybridstorage@vishay.com).

*Statements about product lifetime are based on calculations and internal testing. They should only be interpreted as estimations. Also due to external factors, the lifetime in the field application may deviate from the calculated lifetime. In general, nothing stated herein shall be construed as a guarantee of durability.*



## **Disclaimer**

ALL PRODUCT, PRODUCT SPECIFICATIONS AND DATA ARE SUBJECT TO CHANGE WITHOUT NOTICE TO IMPROVE RELIABILITY, FUNCTION OR DESIGN OR OTHERWISE.

Vishay Intertechnology, Inc., its affiliates, agents, and employees, and all persons acting on its or their behalf (collectively, "Vishay"), disclaim any and all liability for any errors, inaccuracies or incompleteness contained in any datasheet or in any other disclosure relating to any product.

Vishay makes no warranty, representation or guarantee regarding the suitability of the products for any particular purpose or the continuing production of any product. To the maximum extent permitted by applicable law, Vishay disclaims (i) any and all liability arising out of the application or use of any product, (ii) any and all liability, including without limitation special, consequential or incidental damages, and (iii) any and all implied warranties, including warranties of fitness for particular purpose, non-infringement and merchantability.

Statements regarding the suitability of products for certain types of applications are based on Vishay's knowledge of typical requirements that are often placed on Vishay products in generic applications. Such statements are not binding statements about the suitability of products for a particular application. It is the customer's responsibility to validate that a particular product with the properties described in the product specification is suitable for use in a particular application. Parameters provided in datasheets and / or specifications may vary in different applications and performance may vary over time. All operating parameters, including typical parameters, must be validated for each customer application by the customer's technical experts. Product specifications do not expand or otherwise modify Vishay's terms and conditions of purchase, including but not limited to the warranty expressed therein.

Hyperlinks included in this datasheet may direct users to third-party websites. These links are provided as a convenience and for informational purposes only. Inclusion of these hyperlinks does not constitute an endorsement or an approval by Vishay of any of the products, services or opinions of the corporation, organization or individual associated with the third-party website. Vishay disclaims any and all liability and bears no responsibility for the accuracy, legality or content of the third-party website or for that of subsequent links.

Vishay products are not designed for use in life-saving or life-sustaining applications or any application in which the failure of the Vishay product could result in personal injury or death unless specifically qualified in writing by Vishay. Customers using or selling Vishay products not expressly indicated for use in such applications do so at their own risk. Please contact authorized Vishay personnel to obtain written terms and conditions regarding products designed for such applications.

No license, express or implied, by estoppel or otherwise, to any intellectual property rights is granted by this document or by any conduct of Vishay. Product names and markings noted herein may be trademarks of their respective owners.

## Looking for pricing, stock, or lifecycle information?

Click below to explore more details on WIN SOURCE:

 [View MAL219690112E3 on WIN SOURCE](#)

 [Vishay Information](#)

## Optimize Your Supply Chain with WIN SOURCE Solutions

-  Global Sourcing Solution
-  Obsolete Management
-  Cost Control Management
-  Shortage Management
-  Alternative Solution
-  Excess Inventory Management