



**THE DATASHEET OF  
MLX92221LSE-AAA-002-RE**



### Features and Benefits

- Wide operating voltage range: from 2.7V to 24V
- Integrated self-diagnostics
- Chopper-stabilized amplifier stage
- Programmable Built-in negative temperature coefficient
- Reverse Supply Voltage Protection
- Under-Voltage Lockout Protection
- Thermal Protection
- High ESD rating / Excellent EMC performance

### Applications

- Automotive, Consumer and Industrial
- Wiper motor
- Window lifter
- Seatbelt buckle
- Seat positioning
- Sunroof/Tailgate opener
- Electrical power steering

### Ordering information

Part No.	Temperature Code	Package Code	Comment
MLX92221LUA-AAA-xxx-BU	L (-40°C to 150°C)	UA (TO92-3L)	BU (Bulk)
MLX92221LSE-AAA-xxx-RE	L (-40°C to 150°C)	SE (TSOT-23)	RE (Reel)

### 1. Functional Diagram

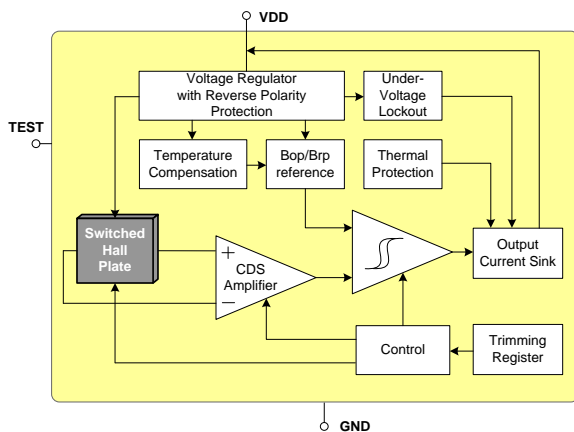

The included voltage regulator operates from 2.7 to 24V, hence covering a wide range of applications. With the built-in reverse voltage protection, a serial resistor or diode on the supply line is not required so that even remote sensors can be specified for low voltage operation down to 2.7V while being reverse voltage tolerant.

In an event of a drop below the minimum supply voltage during operation, the under-voltage lock-out protection will automatically freeze the device, preventing the electrical perturbation to affect the magnetic measurement circuitry. The output current state is therefore only updated based on a proper and accurate magnetic measurement result.

The two-wire interface not only saves one wire, but also allows implementation of diagnostic functions as reverse polarity connection and malfunction detection. The on-chip thermal protection also switches off the output if the junction temperature increases above an abnormally high threshold. It will automatically recover once the temperature decreases below a safe value.

With latching magnetic characteristics, the supply current state is turned high by a sufficiently strong South Pole facing the package branded side. Toggling the state of the supply current from high to low is possible by applying low or no magnetic field.

The MLX92221 is delivered in a Green and RoHS compliant Plastic Single-in-Line (TO-92 flat) for through-hole mount or PCB-less design or in 3-pin Thin Small Outline Transistor (TSOT) for surface mount process

### 2. General Description

The Melexis MLX92221 is a new generation of Hall-effect switches designed in mixed signal submicron CMOS technology.

The device integrates a voltage regulator, Hall sensor with advanced offset cancellation system and a current sink-configured output driver, all in a single package.

Based on a brand-new platform, the magnetic core is using an improved offset cancellation system allowing faster and more accurate processing while being temperature insensitive and stress independent. In addition, a temperature coefficient is implemented to compensate the natural behaviour of certain types of magnets becoming weaker with rise in temperature.

## Contents

Features and Benefits .....	1
Applications .....	1
Ordering information .....	1
1. Functional Diagram .....	1
2. General Description .....	1
3. Absolute Maximum Ratings.....	4
4. General Electrical Specifications.....	5
5. Specifications .....	6
5.1. MLX92221LSE-AAA-001 .....	6
5.2. MLX92221LSE-AAA-002 .....	6
5.3. MLX92221LSE-AAA-003 .....	6
5.4. MLX92221LUA-AAA-004 .....	7
5.5. MLX92221LUA-AAA-005 .....	7
5.6. MLX92221LUA-AAA-006 .....	7
5.7. MLX92221LUA-AAA-007 .....	7
6. Magnetic Behavior .....	8
7. Performance Graphs .....	9
7.1. $I_{OFFLow}$ vs. $T_J$ .....	9
7.2. $I_{OFFHigh}$ vs. $T_J$ .....	9
7.3. $I_{ON}$ vs. $T_J$ .....	9
7.4. $I_{OFFLow}$ vs. $V_{DD}$ .....	9
7.5. $I_{OFFHigh}$ vs. $V_{DD}$ .....	9
7.6. $I_{ON}$ vs. $V_{DD}$ .....	9
7.7. $V_{DD}$ de-rating.....	10
7.8. Power de-rating.....	10
8. Application Information .....	11
8.1. Typical Automotive Application Circuit .....	11
8.2. Automotive and Harsh, Noisy Environments Application Circuit .....	11
8.3. Strobing $V_{DD}$ application (used for reduced self-heating) .....	11
9. Standard information regarding the manufacturability of Melexis products .....	12
10. ESD Precautions .....	12
11. Package Information .....	13

11.1. TSOT-3L (SE Package) .....	13
11.2. TO92-3L (UA Package).....	15
<b>12. Contact .....</b>	<b>17</b>
<b>13. Disclaimer .....</b>	<b>17</b>

### 3. Absolute Maximum Ratings

Parameter	Symbol	Value	Units
Supply Voltage <sup>(1, 2)</sup>	V <sub>DD</sub>	+27	V
Supply Current <sup>(1, 2, 3)</sup>	I <sub>DD</sub>	+20	mA
Supply Current <sup>(1, 3, 4)</sup>	I <sub>DD</sub>	+50	mA
Reverse Supply Voltage <sup>(1, 2)</sup>	V <sub>DDREV</sub>	-24	V
Reverse Supply Current <sup>(1, 2, 5)</sup>	I <sub>DDREV</sub>	-20	mA
Reverse Supply Current <sup>(1, 4, 5)</sup>	I <sub>DDREV</sub>	-50	mA
Maximum Junction Temperature <sup>(6)</sup>	T <sub>J</sub>	+165	°C
Operating Temperature Range	T <sub>A</sub>	-40 to 150	°C
Storage Temperature Range	T <sub>S</sub>	-55 +165	°C
ESD Sensitivity – HBM <sup>(7)</sup>	-	3000	V
ESD Sensitivity – MM <sup>(8)</sup>	-	400	V
ESD Sensitivity – CDM <sup>(9)</sup>	-	1000	V
Magnetic Flux Density	B	Unlimited	mT

Exceeding the absolute maximum ratings may cause permanent damage. Exposure to absolute-maximum-rated conditions for extended periods may affect device reliability.

---

<sup>1</sup> The maximum junction temperature should not be exceeded

<sup>2</sup> For maximum 1 hour

<sup>3</sup> Including current through protection device

<sup>4</sup> For maximum 1 second

<sup>5</sup> Through protection device

<sup>6</sup> For 1000 hours

<sup>7</sup> Human Model according AEC-Q100-002 standard

<sup>8</sup> Machine Model according AEC-Q100-003 standard

<sup>9</sup> Charged Device Model according AEC-Q100-011 standard

## 4. General Electrical Specifications

DC Operating Parameters  $V_{DD} = 2.7$  to  $24V$ ,  $T_J = -40^{\circ}C$  to  $165^{\circ}C$  (unless otherwise specified)

Parameter	Symbol	Test Conditions	Min	Typ <sup>(1)</sup>	Max	Units
Supply Voltage	$V_{DD}$	Operating	2.7	-	24	V
Reverse Supply Current	$I_{DDREV}$	$V_{DD} = -16V$			1	mA
OFF Supply Current	$I_{OFFLOW}$	$V_{DD} = 3.5$ to $24V$	2	3.3	5	mA
OFF Supply Current	$I_{OFFHIGH}$	$V_{DD} = 3.5$ to $24V$	5	6	6.9	mA
ON Supply Current	$I_{ON}$	$V_{DD} = 3.5$ to $24V$	12	14.5	17	mA
Safe Mode Supply Current	$I_{TP}$	Thermal Protection activated	-	-	0.8	mA
Supply Current Rise/Fall Time <sup>(2)</sup>	$t_{RISE/FALL}$	$V_{DD} = 12V$ , $C_{LOAD} = 50pF$ to GND	0.1	0.3	1	$\mu s$
Power-On Time <sup>(3,4,5)</sup>	$t_{ON}$	$V_{DD} = 5V$ , $dV_{DD}/dt > 2V/\mu s$	-	40	70	$\mu s$
Chopping Frequency	$f_{CHOP}$		260	340	-	kHz
Delay time <sup>(2,6)</sup>	$t_D$	Average value for 1000 successive switching events @10kHz, Square wave with $B \geq 3 * B_{OPMAX}$ , $t_{RISE} = t_{FALL} \leq 20\mu s$	-	7.5	-	$\mu s$
Output Jitter (p-p) <sup>(2,7)</sup>	$t_{JITTER}$	Square wave with $B \geq 3 * B_{OPMAX}$ over 1000 successive switching events @1kHz	-	$\pm 3.3$	-	$\mu s$
Maximum Switching Frequency <sup>(2,8)</sup>	$f_{SW}$	$B \geq 3 * B_{OPMAX}$ and square wave magnetic field	30	50	-	kHz
Under-voltage Lockout Threshold	$V_{UVL}$		-	2	2.7	V
Under-voltage Lockout Reaction time <sup>(2)</sup>	$t_{UVL}$		-	1	-	$\mu s$
Thermal Protection Threshold	$T_{PROT}$	Junction temperature	-	190 <sup>(9)</sup>	-	$^{\circ}C$
Thermal Protection Release	$T_{REL}$	Junction temperature	-	180 <sup>(9)</sup>	-	$^{\circ}C$
Safe Mode Supply Current	$I_{TP}$	Thermal Protection activated	-	-	0.8	mA
UA Package Thermal Resistance	$R_{TH}$	Single layer (1S) Jeduc board, zero LFPM		200		$^{\circ}C/W$
TSOT Package Thermal Resistance	$R_{TH}$	Single layer (1S) Jeduc board, zero LFPM		300		$^{\circ}C/W$

<sup>1</sup> Typical values are defined at  $T_A = +25^{\circ}C$  and  $V_{DD} = 12V$

<sup>2</sup> Guaranteed by design and verified by characterization, not production tested

<sup>3</sup> The Power-On Time represents the time from reaching  $V_{DD} = V_{POR}$  to the first refresh of the supply current state.

<sup>4</sup> Power-On Slew Rate is not critical for the proper device start-up.

<sup>5</sup>  $B > B_{OPmax} + 1$  mT for direct output sensors, or  $B < B_{RPmin} - 1$  mT.

<sup>6</sup> Delay Time is the time from magnetic threshold reached to the start of the supply current switching.

<sup>7</sup> Output jitter is the unpredictable deviation of the Delay time

<sup>8</sup> Maximum switching frequency corresponds to the maximum frequency of the applied magnetic field which is detected without loss of pulses

<sup>9</sup>  $T_{PROT}$  and  $T_{REL}$  are the corresponding junction temperature values.

## 5. Specifications

### 5.1. MLX92221LSE-AAA-001

DC Operating Parameters  $V_{DD} = 3.5V$  to  $24V$ ,  $T_J = -40^{\circ}C$  to  $165^{\circ}C$

Test Condition	Operating Point $B_{OP}$ (mT)			Release Point $B_{RP}$ (mT)			TC (ppm/ $^{\circ}C$ )	$I_{OFF}$ (mA)	Active Pole
	Min	Typ <sup>(1)</sup>	Max	Min	Typ <sup>(1)</sup>	Max			
$T_J = -40^{\circ}C$	7.4	11.8	16.3	-7.4	-11.8	-16.3	0 <sup>(2)</sup>	6	South pole
$T_J = 25^{\circ}C$	7.4	11.8	16.3	-7.4	-11.8	-16.3			
$T_J = 150^{\circ}C$	7.4	11.8	16.3	-7.4	-11.8	-16.3			

### 5.2. MLX92221LSE-AAA-002

DC Operating Parameters  $V_{DD} = 3.5V$  to  $24V$ ,  $T_J = -40^{\circ}C$  to  $165^{\circ}C$

Test Condition	Operating Point $B_{OP}$ (mT)			Release Point $B_{RP}$ (mT)			TC (ppm/ $^{\circ}C$ )	$I_{OFF}$ (mA)	Active Pole
	Min	Typ <sup>(1)</sup>	Max	Min	Typ <sup>(1)</sup>	Max			
$T_J = -40^{\circ}C$	4.1	6.8	9.6	-9.6	-6.8	-4.1	-2000 <sup>(2)</sup>	6	South pole
$T_J = 25^{\circ}C$	4.1	6	7.9	-7.9	-6	-4.1			
$T_J = 150^{\circ}C$	1.8	4.5	7.1	-7.1	-4.5	-1.8			

### 5.3. MLX92221LSE-AAA-003

DC Operating Parameters  $V_{DD} = 3.5V$  to  $24V$ ,  $T_J = -40^{\circ}C$  to  $165^{\circ}C$

Test Condition	Operating Point $B_{OP}$ (mT)			Release Point $B_{RP}$ (mT)			TC (ppm/ $^{\circ}C$ )	$I_{OFF}$ (mA)	Active Pole
	Min	Typ <sup>(1)</sup>	Max	Min	Typ <sup>(1)</sup>	Max			
$T_J = -40^{\circ}C$	0.5	2	3.2	-3.2	-2	-0.5	0 <sup>(2)</sup>	6	South pole
$T_J = 25^{\circ}C$	0.8	1.8	2.8	-2.8	-1.8	-0.8			
$T_J = 150^{\circ}C$	0.3	1.8	3.3	-3.3	-1.8	-0.3			

<sup>1</sup> Typical values are defined at  $T_A = +25^{\circ}C$  and  $V_{DD} = 12V$

<sup>2</sup> Temperature coefficient is calculated using the following formula:

$$\frac{(B_{OPT2} - B_{RPT2}) - (B_{OPT1} - B_{RPT1})}{(B_{OP25^{\circ}C} - B_{RP25^{\circ}C})} \times (T_2 - T_1) * 10^6, ppm/^{\circ}C; T_1 = 25^{\circ}C; T_2 = 150^{\circ}C$$

### 5.4. MLX92221LUA-AAA-004

DC Operating Parameters  $V_{DD} = 3.5V$  to  $24V$ ,  $T_J = -40^{\circ}C$  to  $165^{\circ}C$

Test Condition	Operating Point $B_{OP}$ (mT)			Release Point $B_{RP}$ (mT)			TC (ppm/ $^{\circ}C$ )	$I_{OFF}$ (mA)	Active Pole
	Min	Typ <sup>(1)</sup>	Max	Min	Typ <sup>(1)</sup>	Max			
$T_J = -40^{\circ}C$	4.4	6.4	8.6	-8.6	-6.4	-4.4	-1100 <sup>(2)</sup>	6	South pole
$T_J = 25^{\circ}C$	4.2	6	7.8	-7.8	-6	-4.2			
$T_J = 150^{\circ}C$	3.2	5.2	7.2	-7.2	-5.2	-3.2			

### 5.5. MLX92221LUA-AAA-005

DC Operating Parameters  $V_{DD} = 3.5V$  to  $24V$ ,  $T_J = -40^{\circ}C$  to  $165^{\circ}C$

Test Condition	Operating Point $B_{OP}$ (mT)			Release Point $B_{RP}$ (mT)			TC (ppm/ $^{\circ}C$ )	$I_{OFF}$ (mA)	Active Pole
	Min	Typ <sup>(1)</sup>	Max	Min	Typ <sup>(1)</sup>	Max			
$T_J = -40^{\circ}C$	0.5	2	3.2	-3.2	-2	-0.5	0 <sup>(2)</sup>	6	South pole
$T_J = 25^{\circ}C$	0.8	1.8	2.8	-2.8	-1.8	-0.8			
$T_J = 150^{\circ}C$	0.3	1.8	3.3	-3.3	-1.8	-0.3			

### 5.6. MLX92221LUA-AAA-006

DC Operating Parameters  $V_{DD} = 3.5V$  to  $9.3V$ ,  $T_J = -40^{\circ}C$  to  $165^{\circ}C$

Test Condition	Operating Point $B_{OP}$ (mT)			Release Point $B_{RP}$ (mT)			TC (ppm/ $^{\circ}C$ )	$I_{OFF}$ (mA)	Active Pole
	Min	Typ <sup>(1)</sup>	Max	Min	Typ <sup>(1)</sup>	Max			
$T_J = -40^{\circ}C$	-0.5	1.25	2	-2	-1.25	0.5	0 <sup>(2)</sup>	6	South pole
$T_J = 25^{\circ}C$	0	0.8	1.6	-1.6	-0.8	0			
$T_J = 150^{\circ}C$	-0.5	1.25	2	-2	-1.25	0.5			

### 5.7. MLX92221LUA-AAA-007

DC Operating Parameters  $V_{DD} = 3.5V$  to  $24V$ ,  $T_J = -40^{\circ}C$  to  $165^{\circ}C$

Test Condition	Operating Point $B_{OP}$ (mT)			Release Point $B_{RP}$ (mT)			TC (ppm/ $^{\circ}C$ )	$I_{OFF}$ (mA)	Active Pole
	Min	Typ <sup>(1)</sup>	Max	Min	Typ <sup>(1)</sup>	Max			
$T_J = -40^{\circ}C$	7.4	11.8	16.3	-7.4	-11.8	-16.3	0 <sup>(2)</sup>	6	South pole
$T_J = 25^{\circ}C$	7.4	11.8	16.3	-7.4	-11.8	-16.3			
$T_J = 150^{\circ}C$	7.4	11.8	16.3	-7.4	-11.8	-16.3			

<sup>1</sup> Typical values are defined at  $T_A = +25^{\circ}C$  and  $V_{DD} = 12V$

<sup>2</sup> Temperature coefficient is calculated using the following formula:

$$\frac{(B_{OPT2} - B_{RPT2}) - (B_{OPT1} - B_{RPT1})}{(B_{OP25^{\circ}C} - B_{RP25^{\circ}C})} \times (T_2 - T_1) * 10^6, ppm/^{\circ}C; T_1 = 25^{\circ}C; T_2 = 150^{\circ}C$$

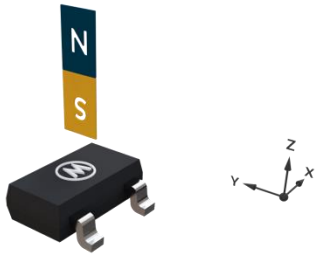

South active pole

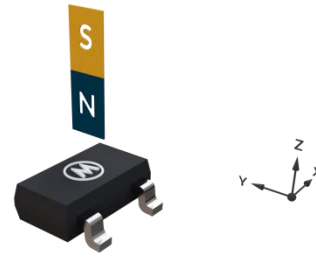

North active pole

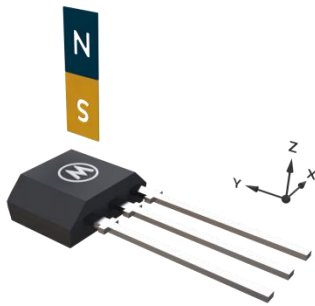

South active pole

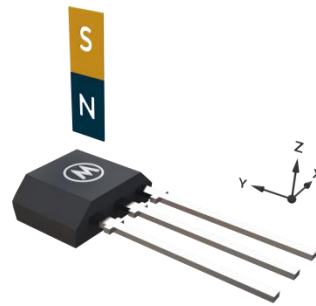

North active pole

## 6. Magnetic Behavior

Note: Latch sensors are inherently Direct South or Direct North Pole Active only.

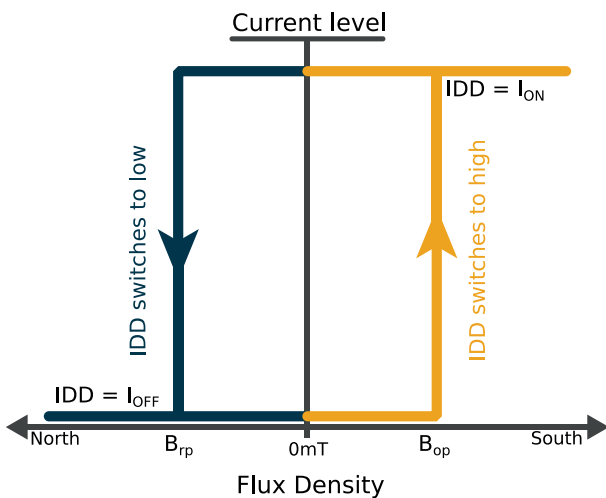

South Active Pole

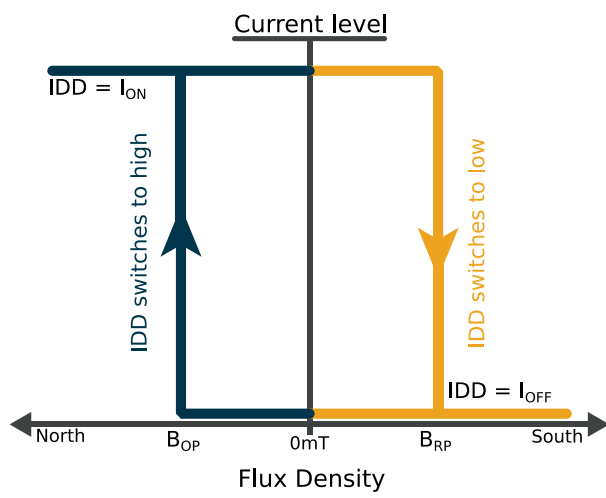

North Active Pole

## 7. Performance Graphs

7.1.  $I_{OFFLow}$  VS.  $T_J$

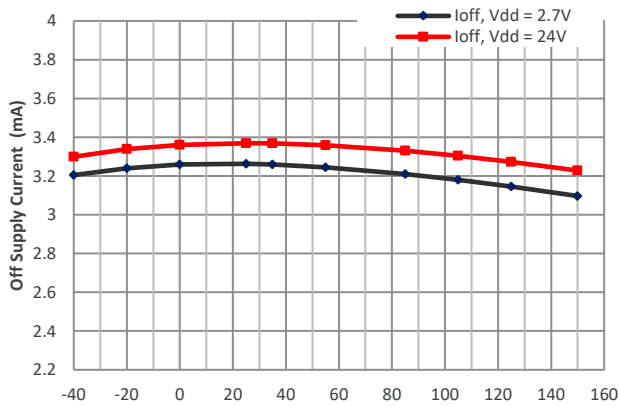

7.4.  $I_{OFFLow}$  VS.  $V_{DD}$

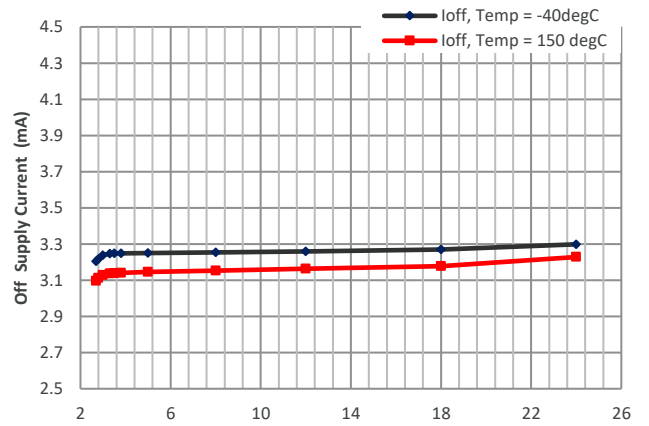

7.2.  $I_{OFFHigh}$  VS.  $T_J$

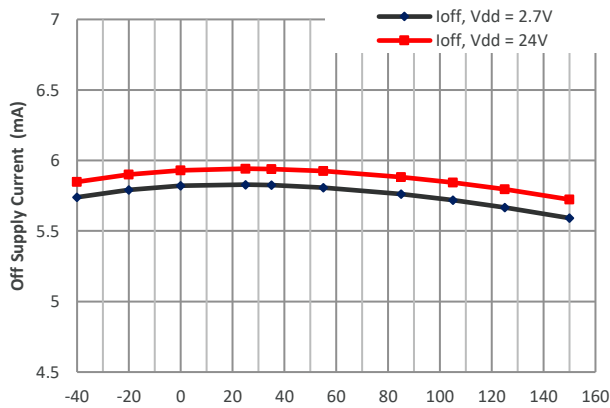

7.5.  $I_{OFFHigh}$  VS.  $V_{DD}$

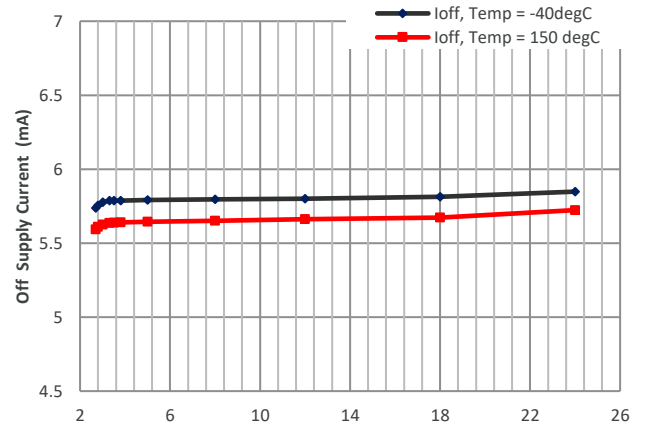

7.3.  $I_{ON}$  VS.  $T_J$

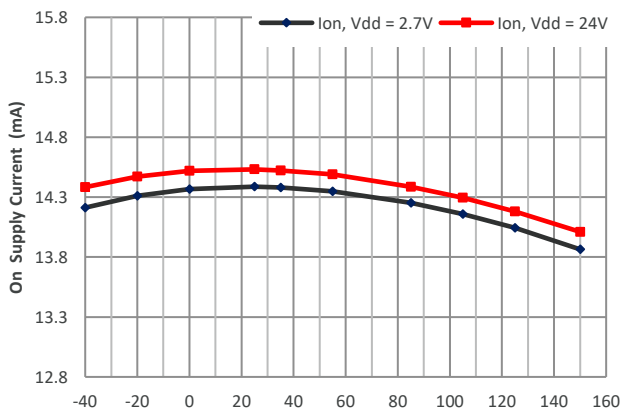

7.6.  $I_{ON}$  VS.  $V_{DD}$

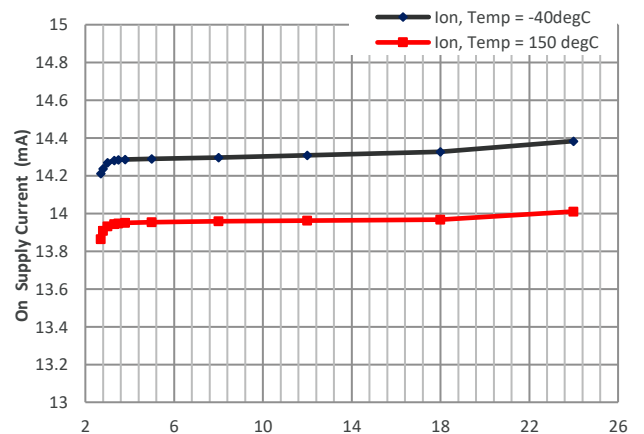

### 7.7. V<sub>DD</sub> de-rating

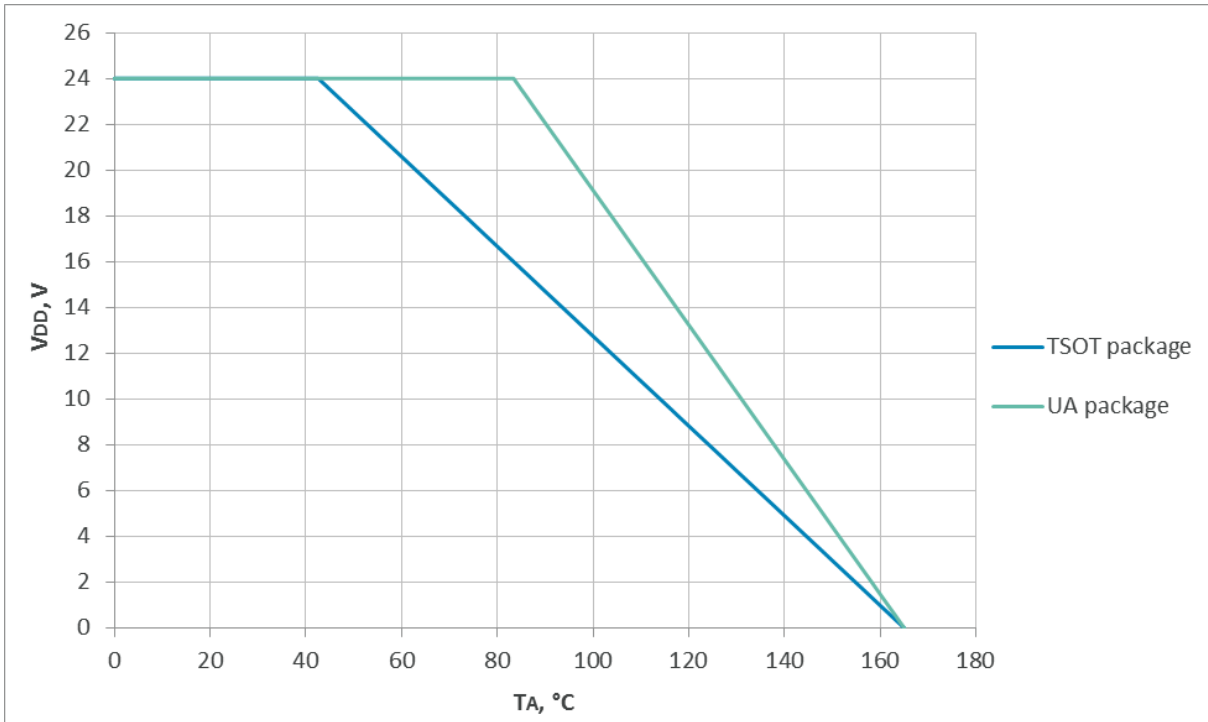

### 7.8. Power de-rating

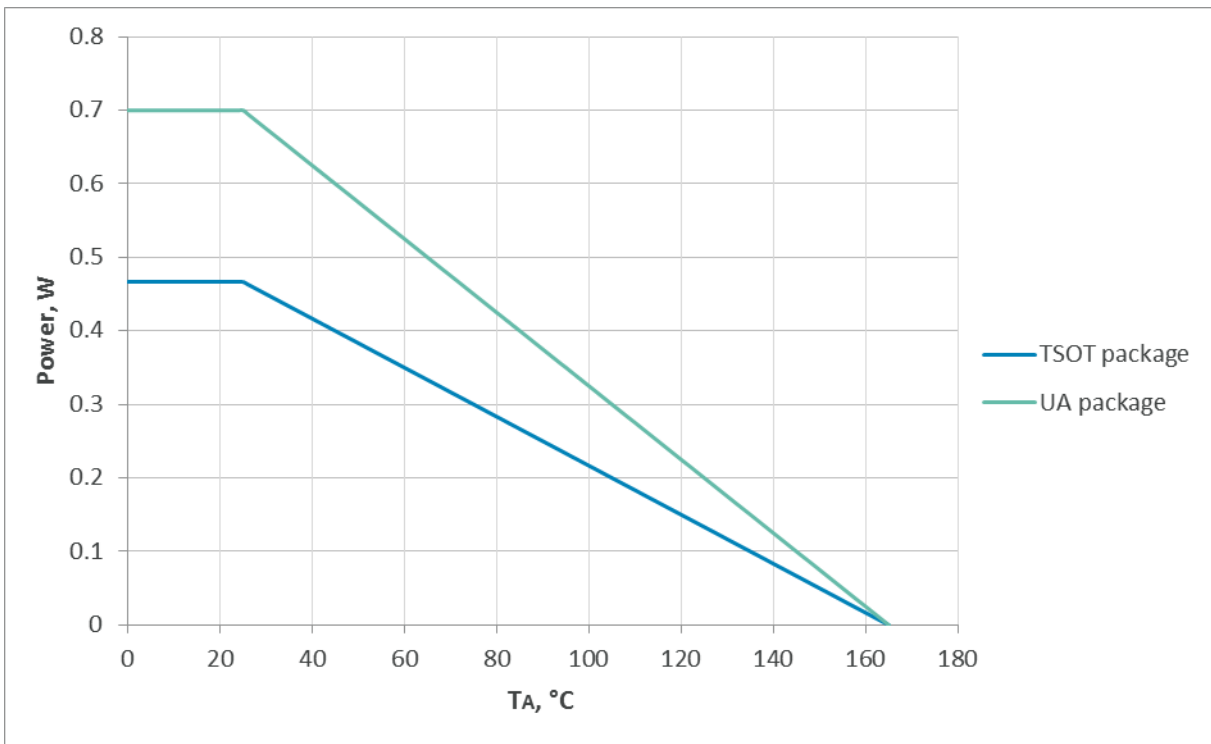

## 8. Application Information

### 8.1. Typical Automotive Application Circuit

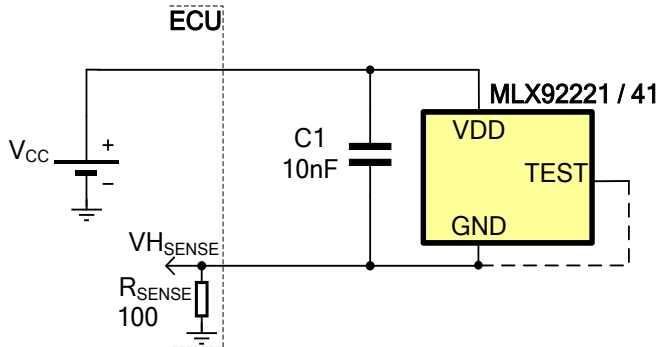

1. For proper operation, a 10nF bypass should be placed as close as possible to the V<sub>DD</sub> and ground.  
For complete emissions protection a C1 = 68nF is Recommended.
2. The test pin is to be left open or connected to GND.

### 8.2. Automotive and Harsh, Noisy Environments Application Circuit

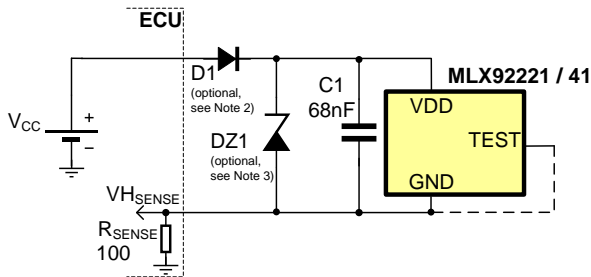

**Notes:**

1. For proper operation, a 10nF to 100nF bypass capacitor should be placed as close as possible to the V<sub>DD</sub> and ground pin.
2. The device could tolerate negative voltage down to -24V, so if negative transients over supply line V<sub>PEAK</sub> < -29V are expected, usage of the diode D1 is recommended. Otherwise only R<sub>SENSE</sub> is sufficient.  
When selecting the resistor R<sub>SENSE</sub>, three points are important:
  - the resistor has to limit I<sub>DD</sub>/I<sub>DDREV</sub> to 50mA maximum
  - the resistor has to withstand the power dissipated in both over voltage conditions (V<sub>SENSE</sub><sup>2</sup>/R<sub>SENSE</sub>)
  - the resulting device supply voltage V<sub>DD</sub> has to be higher than V<sub>DD min</sub> (V<sub>DD</sub> = V<sub>CC</sub> - R<sub>SENSE</sub>·I<sub>DD</sub>)
3. The device could tolerate positive supply voltage up to +27V (until the maximum power dissipation is not exceeded), so if positive transients over supply line with V<sub>PEAK</sub> > 32V are expected, usage a zener diode DZ1 is recommended. The R<sub>SENSE</sub>-DZ1 network should be sized to limit the voltage over the device below the maximum allowed.

### 8.3. Strobing V<sub>DD</sub> application (used for reduced self-heating)

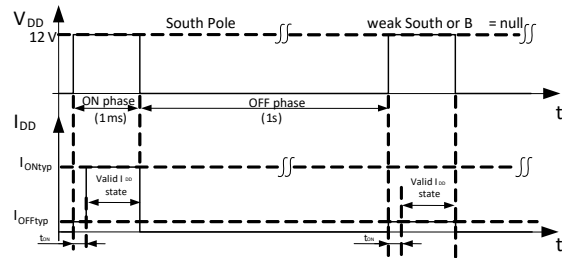
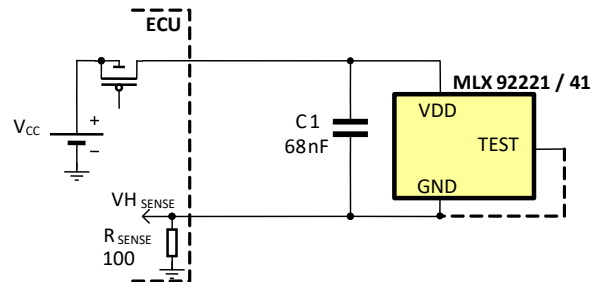

**Notes:**

1. Given strobe timing is exemplary only.
2. For proper operation, a 10nF to 100nF bypass capacitor should be placed as close as possible to the V<sub>DD</sub> and ground pin.

## 9. Standard information regarding the manufacturability of Melexis products

Our products are classified and qualified regarding soldering technology, solderability and moisture sensitivity level according to following test methods:

### Reflow Soldering SMD's (Surface Mount Devices)

- IPC/JEDEC J-STD-020  
Moisture/Reflow Sensitivity Classification for Nonhermetic Solid State Surface Mount Devices (classification reflow profiles according to table 5-2)
- EIA/JEDEC JESD22-A113  
Preconditioning of Nonhermetic Surface Mount Devices Prior to Reliability Testing (reflow profiles according to table 2)

### Wave Soldering SMD's (Surface Mount Devices) and THD's (Through Hole Devices)

- EN60749-20  
Resistance of plastic- encapsulated SMD's to combined effect of moisture and soldering heat
- EIA/JEDEC JESD22-B106 and EN60749-15  
Resistance to soldering temperature for through-hole mounted devices

### Iron Soldering THD's (Through Hole Devices)

- EN60749-15  
Resistance to soldering temperature for through-hole mounted devices

### Solderability SMD's (Surface Mount Devices) and THD's (Through Hole Devices)

- EIA/JEDEC JESD22-B102 and EN60749-21  
Solderability

For all soldering technologies deviating from above mentioned standard conditions (regarding peak temperature, temperature gradient, temperature profile etc) additional classification and qualification tests have to be agreed upon with Melexis.

The application of Wave Soldering for SMD's is allowed only after consulting Melexis regarding assurance of adhesive strength between device and board.

<http://www.melexis.com/Assets/Soldering-Application-Note-and-Recommendations-5446.aspx>

Melexis is contributing to global environmental conservation by promoting **lead free** solutions. For more information on qualifications of **RoHS** compliant products (RoHS = European directive on the Restriction Of the use of certain Hazardous Substances) please visit the quality page on our website: <http://www.melexis.com/quality.aspx>

## 10. ESD Precautions

Electronic semiconductor products are sensitive to Electro Static Discharge (ESD).

Always observe Electro Static Discharge control procedures whenever handling semiconductor products.

## 11. Package Information

### 11.1. TSOT-3L (SE Package)

#### 11.1.1. TSOT-3L – Package dimensions

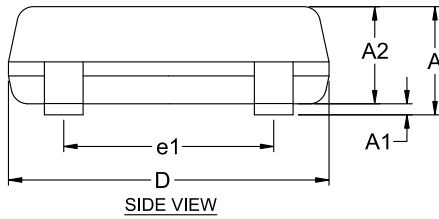
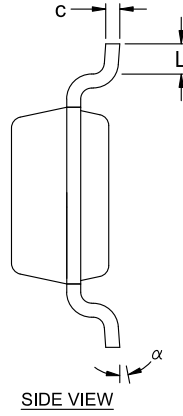
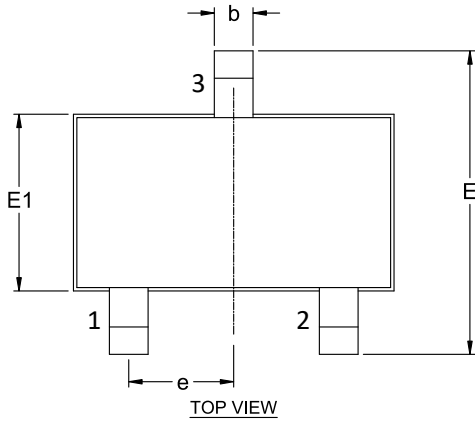

SYMBOL	MINIMUM	MAXIMUM
A	---	1.00
A1	0.025	0.10
A2	0.85	0.90
D	2.80	3.00
E	2.60	3.00
E1	1.50	1.70
L	0.30	0.50
b	0.30	0.45
c	0.10	0.20
e	0.95 BSC	
e1	1.90 BSC	
α	0°	8°

NOTE :

1. ALL DIMENSIONS IN MILLIMETERS (mm) UNLESS OTHERWISE STATED.
2. DIMENSION D DOES NOT INCLUDE MOLD FLASH OR PROTRUSIONS OF MAX 0.15 mm PER SIDE.
3. DIMENSION E DOES NOT INCLUDE MOLD FLASH OR PROTRUSIONS OF MAX 0.25 mm PER SIDE.
4. DIMENSION b DOES NOT INCLUDE DAMBAR PROTRUSION OF MAX 0.07 mm.
5. DIMENSION L IS THE LENGTH OF THE TERMINAL FOR SOLDERING TO A SUBSTRATE.
6. FORMED LEAD SHALL BE PLANAR WITH RESPECT TO ONE ANOTHER WITH 0.076 mm SEATING PLANE.

#### 11.1.2. TSOT-3L – Sensitive spot

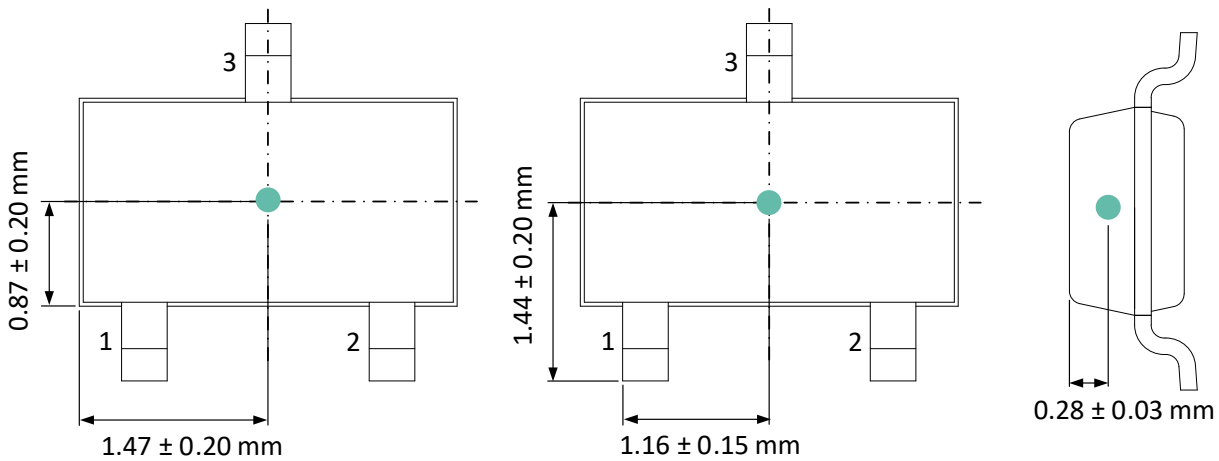

### 11.1.3. TSOT-3L – Package marking / Pin definition

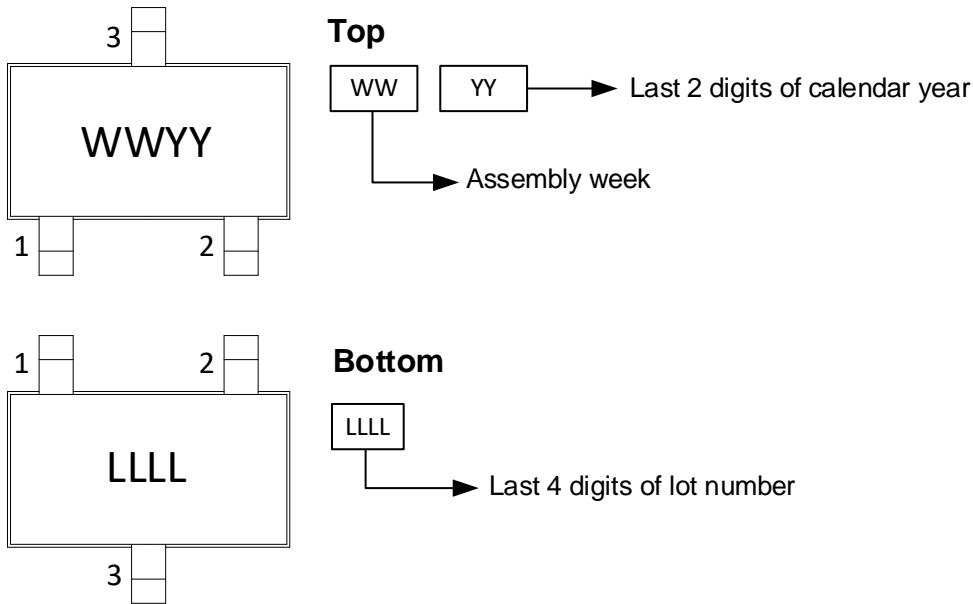

Pin #	Name	Type	Function
1	VDD	Supply	Supply Voltage pin
2	TEST	I/O	For Melexis use only
3	GND	Ground	Ground pin

## 11.2. TO92-3L (UA Package)

### 11.2.1. TO92-3L – Package dimensions

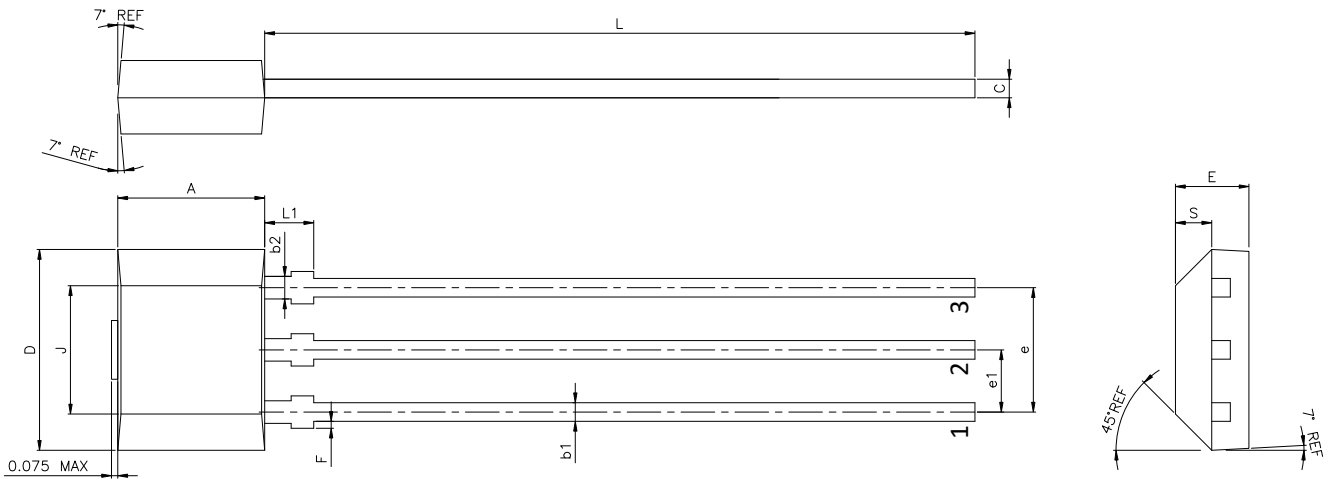

SYMBOL	MINIMUM	MAXIMUM
A	2.90	3.10
D	4.00	4.20
E	1.40	1.60
F	0.00	0.15
J	2.51	2.72
L	14.00	15.00
L1	0.90	1.10
S	0.63	0.84
b1	0.35	0.44
b2	0.43	0.52
c	0.35	0.44
e	2.51	2.57
e1	1.24	1.30

NOTES :

1. DIMENSIONS IN MILLIMETERS (mm) UNLESS NOTED OTHERWISE.
2. PACKAGE DIMENSIONS DO NOT INCLUDE MOLD FLASHES AND PROTRUSIONS.
3. DIMENSION A AND D DO NOT INCLUDE MOLD GATE AND SIDE FLASH (PROTRUSION) of MAXIMUM 0.127 mm PER SIDE.
4. THE LEADS MAY BE SLIGHTLY DEFORMED DURING TRANSPORTATION IF PACKED IN BULK (BAG), AFFECTING e1 DIMENSION. IT IS RECOMMENDED TO ORDER RADIAL TAPE (REEL OR AMMOPACK) IF SUCH DEFORMATION IS CRITICAL FOR THE LEAD FORMING PROCESS, EVEN IF MANUAL LOADING INTO THE TOOL IS FORESEEN.

### 11.2.2. TO92-3L – Sensitive spot

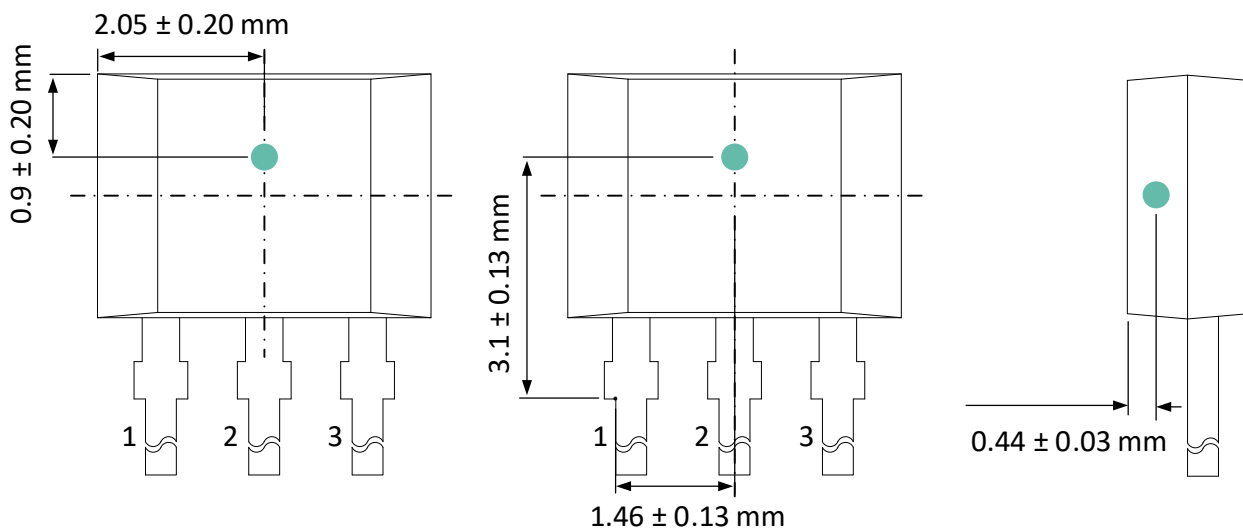

### 11.2.3. TO92-3L – Package marking / Pin definition

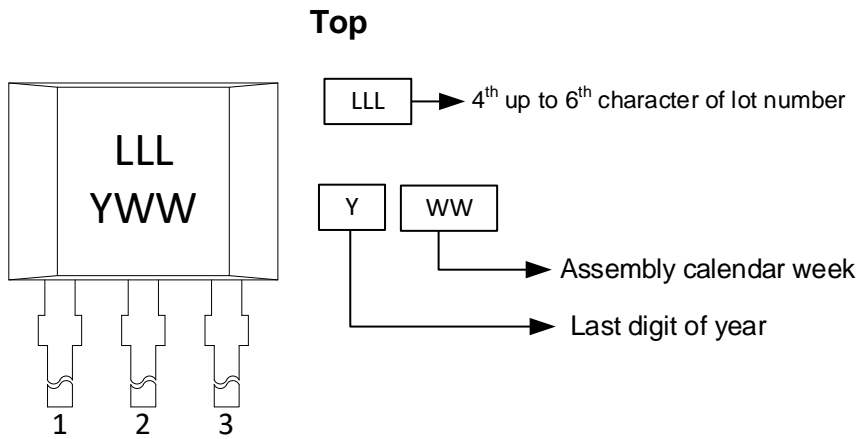

Pin #	Name	Type	Function
1	VDD	Supply	Supply Voltage pin
2	GND	Ground	Ground pin
3	TEST	I/O	For Melexis use only

## 12. Contact

For the latest version of this document, go to our website at [www.melexis.com](http://www.melexis.com).

For additional information, please contact our Direct Sales team and get help for your specific needs:

Europe, Africa	Telephone: +32 13 67 04 95
	Email : sales_europe@melexis.com
Americas	Telephone: +1 603 223 2362
	Email : sales_usa@melexis.com
Asia	Email : sales_asia@melexis.com

## 13. Disclaimer

*The content of this document is believed to be correct and accurate. However, the content of this document is furnished "as is" for informational use only and no representation, nor warranty is provided by Melexis about its accuracy, nor about the results of its implementation. Melexis assumes no responsibility or liability for any errors or inaccuracies that may appear in this document. Customer will follow the practices contained in this document under its sole responsibility. This documentation is in fact provided without warranty, term, or condition of any kind, either implied or expressed, including but not limited to warranties of merchantability, satisfactory quality, non-infringement, and fitness for purpose. Melexis, its employees and agents and its affiliates' and their employees and agents will not be responsible for any loss, however arising, from the use of, or reliance on this document. Notwithstanding the foregoing, contractual obligations expressly undertaken in writing by Melexis prevail over this disclaimer.*

*This document is subject to change without notice, and should not be construed as a commitment by Melexis. Therefore, before placing orders or prior to designing the product into a system, users or any third party should obtain the latest version of the relevant information. Users or any third party must determine the suitability of the product described in this document for its application, including the level of reliability required and determine whether it is fit for a particular purpose.*

*This document as well as the product here described may be subject to export control regulations. Be aware that export might require a prior authorization from competent authorities. The product is not designed, authorized or warranted to be suitable in applications requiring extended temperature range and/or unusual environmental requirements. High reliability applications, such as medical life-support or life-sustaining equipment or avionics application are specifically excluded by Melexis. The product may not be used for the following applications subject to export control regulations: the development, production, processing, operation, maintenance, storage, recognition or proliferation of:*

- 1. chemical, biological or nuclear weapons, or for the development, production, maintenance or storage of missiles for such weapons;*
- 2. civil firearms, including spare parts or ammunition for such arms;*
- 3. defense related products, or other material for military use or for law enforcement;*
- 4. any applications that, alone or in combination with other goods, substances or organisms could cause serious harm to persons or goods and that can be used as a means of violence in an armed conflict or any similar violent situation.*

*No license nor any other right or interest is granted to any of Melexis' or third party's intellectual property rights.*

*If this document is marked "restricted" or with similar words, or if in any case the content of this document is to be reasonably understood as being confidential, the recipient of this document shall not communicate, nor disclose to any third party, any part of the document without Melexis' express written consent. The recipient shall take all necessary measures to apply and preserve the confidential character of the document. In particular, the recipient shall (i) hold document in confidence with at least the same degree of care by which it maintains the confidentiality of its own proprietary and confidential information, but no less than reasonable care; (ii) restrict the disclosure of the document solely to its employees for the purpose for which this document was received, on a strictly need to know basis and providing that such persons to whom the document is disclosed are bound by confidentiality terms substantially similar to those in this disclaimer; (iii) use the document only in connection with the purpose for which this document was received, and reproduce document only to the extent necessary for such purposes; (iv) not use the document for commercial purposes or to the detriment of Melexis or its customers. The confidentiality obligations set forth in this disclaimer will have indefinite duration and in any case they will be effective for no less than 10 years from the receipt of this document.*

*This disclaimer will be governed by and construed in accordance with Belgian law and any disputes relating to this disclaimer will be subject to the exclusive jurisdiction of the courts of Brussels, Belgium.*



*The invalidity or ineffectiveness of any of the provisions of this disclaimer does not affect the validity or effectiveness of the other provisions. The previous versions of this document are repealed.*

*Melexis © - No part of this document may be reproduced without the prior written consent of Melexis. (2022)*







*IATF 16949 and ISO 14001 Certified*

## Looking for pricing, stock, or lifecycle information?

Click below to explore more details on WIN SOURCE:

-  [View MLX92221LSE-AAA-002-RE on WIN SOURCE](#)
-  [Melexis Technologies NV Information](#)

## Optimize Your Supply Chain with WIN SOURCE Solutions

-  Global Sourcing Solution
-  Obsolete Management
-  Cost Control Management
-  Shortage Management
-  Alternative Solution
-  Excess Inventory Management