

WIN*SOURCE*
ELECTRONICS

THE DATASHEET OF
1437284-9



1437284-9 ✓ ACTIVE

AMP | SUPERSEAL 1.0mm

TE Internal #: 1437284-9

Socket, Pin Diameter 1.94 mm [.076 in], 20 – 14 AWG Wire Size, .5 – 2 mm² Wire Size, SUPERSEAL 1.0mm, Automotive Terminals

[View on TE.com >](#)



Terminals & Splices > Automotive Terminals > SUPERSEAL Connector Contacts: 1.0 mm



Terminal Type: **Socket**

Mating Pin Diameter: **1.94 mm [.076 in]**

Terminal Transmits: **0 – 24 A (Low Power)**

Wire Size: **.5 – 2 mm²**

[All SUPERSEAL Connector Contacts: 1.0 mm \(6\)](#)

Features

Product Type Features

Sealable	No
----------	----

Contact Features

Wire Contact Termination Area Plating Material	Tin
Crimp Type	F-Crimp
Terminal Type	Socket
Mating Pin Diameter	1.94 mm [.076 in]
Interface Plating	Gold (Au)

Termination Features

Termination Method to Wire & Cable	Crimp
Product Terminates To	Wire

Dimensions

Compatible Insulation Diameter Range	1.77 – 2.46 mm [.069 – .096 in]
Wire Size	.5 – 2 mm ²
Wire Size Search	14 AWG, 15 AWG, 16 AWG, 17 AWG, 18 AWG, 19 AWG, 20 AWG

Usage Conditions

Insulation Option	Uninsulated
-------------------	-------------

Operation/Application



Compatible With Wire Base Material	Copper
------------------------------------	--------

Packaging Features

Packaging Quantity	7000
Packaging Method	Package

Other

Customer Preferred Contact	No
Terminal Transmits	0 – 24 A (Low Power)

Product Compliance

[For compliance documentation, visit the product page on TE.com>](#)

EU RoHS Directive 2011/65/EU	Compliant
EU ELV Directive 2000/53/EC	Compliant
China RoHS 2 Directive MIIT Order No 32, 2016	No Restricted Materials Above Threshold
EU REACH Regulation (EC) No. 1907/2006	Current ECHA Candidate List: JUNE 2024 (241) Candidate List Declared Against: JUNE 2024 (241) Does not contain REACH SVHC
Halogen Content	Low Halogen - Br, Cl, F, I < 900 ppm per homogenous material. Also BFR/CFR/PVC Free
Solder Process Capability	Not reviewed for solder process capability

Product Compliance Disclaimer

This information is provided based on reasonable inquiry of our suppliers and represents our current actual knowledge based on the information they provided. This information is subject to change. The part numbers that TE has identified as EU RoHS compliant have a maximum concentration of 0.1% by weight in homogenous materials for lead, hexavalent chromium, mercury, PBB, PBDE, DBP, BBP, DEHP, DIBP, and 0.01% for cadmium, or qualify for an exemption to these limits as defined in the Annexes of Directive 2011/65/EU (RoHS2). Finished electrical and electronic equipment products will be CE marked as required by Directive 2011/65/EU. Components may not be CE marked. Additionally, the part numbers that TE has identified as EU ELV compliant have a maximum concentration of 0.1% by weight in homogenous materials for lead, hexavalent chromium, and mercury, and 0.01% for cadmium, or qualify for an exemption to these limits as defined in the Annexes of Directive 2000/53/EC (ELV). Regarding the REACH Regulation, the information TE provides on SVHC in articles for this part number is based on the latest European Chemicals Agency (ECHA) 'Guidance on requirements for substances in articles' posted at this URL: <https://echa.europa.eu/guidance-documents/guidance-on-reach>

Compatible Parts



TE Part # 2836316-1
OCEAN_2.0_Applicator-S-070F090F-RSM



TE Part # 2836316-2
OCEAN_2.0_Applicator-S-070F090F-RSA



TE Part # 2836317-1
OCEAN_2.0_APPLICATOR-S-067F090F-RSM



TE Part # 2836317-2
OCEAN_2.0_APPLICATOR-S-067F090F-RSA



TE Part # 5-2836317-1
OCEAN_2.0_APPLICATOR-S-067F090F-RSM



TE Part # 7-2836316-7
OCEAN_2.0_SPARE_PART_KIT-070F090F



TE Part # 7-2836317-7
OCEAN_2.0_SPARE_PART_KIT-067F090F



TE Part # 91390-1
PRO-C TL & DIE 1MM SYS 20-16



TE Part # 1437303-9
1600126=JTEC EXTRACTION TOOL



TE Part # 5-2836317-2
OCEAN_2.0_APPLICATOR-S-067F090F-RSA

Also in the Series | SUPERSEAL 1.0mm



Automotive Housings(14)



Automotive Terminals(6)



Connector Backshells(2)



Connector Seals & Cavity Plugs(1)



PCB Headers & Receptacles(33)

Customers Also Bought

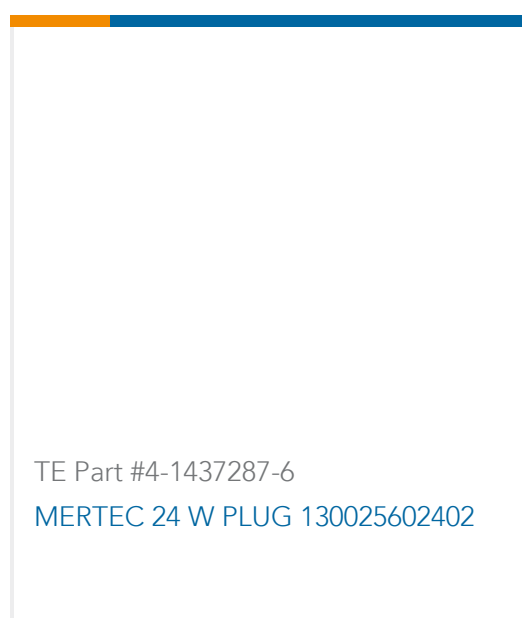
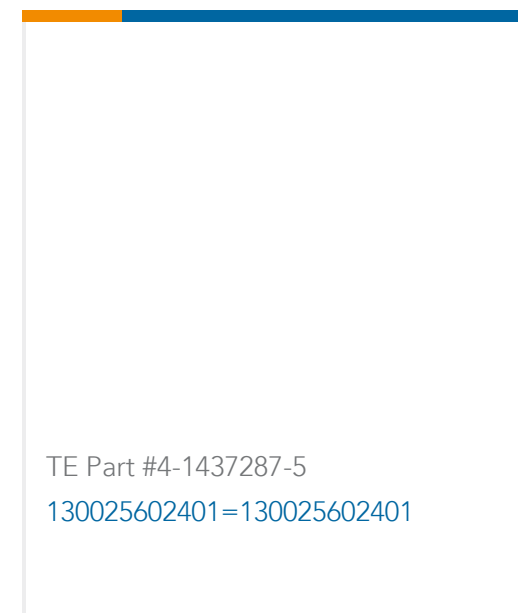
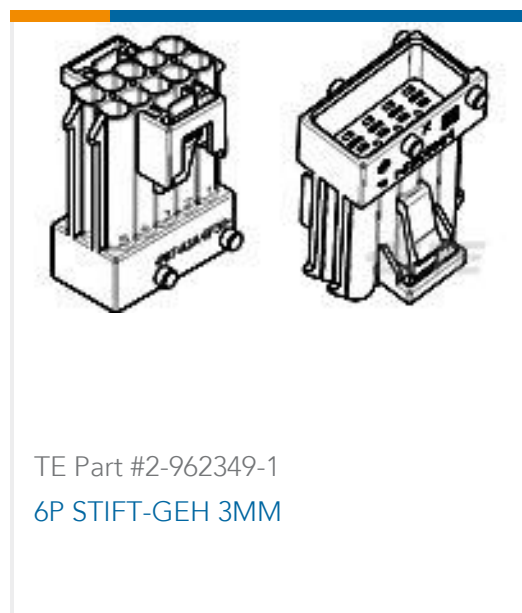

Documents

Product Drawings

[MERTEC FTERM AU 13002630101](#)

English

CAD Files

Customer View Model

[ENG_CVM_1437284-9_B1.3d_igs.zip](#)

English

Customer View Model

[ENG_CVM_1437284-9_B1.3d_stp.zip](#)

English

Customer View Model

[ENG_CVM_1437284-9_B1.2d_dxf.zip](#)

English

3D PDF

English

By downloading the CAD file I accept and agree to the [Terms and Conditions](#) of use.

Datasheets & Catalog Pages

1437284-9

Socket, Pin Diameter 1.94 mm [.076 in], 20 – 14 AWG Wire Size, .5 – 2 mm² Wire Size,
SUPERSEAL 1.0mm, Automotive Terminals



ICT Terminals and Connectors Catalogue

English

Looking for pricing, stock, or lifecycle information?

Click below to explore more details on WIN SOURCE:

[View 1437284-9 on WIN SOURCE](#)

[TE Connectivity Information](#)

Optimize Your Supply Chain with WIN SOURCE Solutions

- ✓ Global Sourcing Solution
- ✓ Obsolete Management
- ✓ Cost Control Management
- ✓ Shortage Management
- ✓ Alternative Solution
- ✓ Excess Inventory Management