



**THE DATASHEET OF
ECS-120-20-5PXDN-TR**



CSM-7XDN SMD CRYSTAL



- -40 ~ +85°C Temp Range
- Low Profile
- Industry Standard Footprint
- Pb Free/RoHS Compliant

DIMENSIONS (mm)

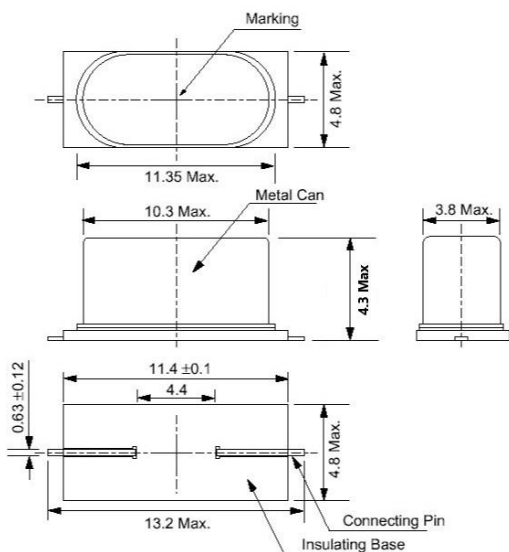

Figure 1) Top, Side, Bottom, and End

Crystal is symmetrical, pin 1 & 2 are interchangeable.

OPERATING CONDITIONS / ELECTRICAL CHARACTERISTICS

PARAMETERS	CONDITIONS	CSM-7XDN			UNITS
		MIN	TYP	MAX	
Frequency		3.57		70.000	MHz
Frequency Tolerance	@ +25°C			± 30	ppm
Frequency Stability	-40 ~ +85°C			± 100	ppm
Shunt Capacitance	Co			7	pF
Load Capacitance	Specify in P/N	10	20	Series	pF
Drive Level	DL			500	μW
Operating Temperature	Topr	-40		+85	°C
Storage Temperature	Tstg	-55		+125	°C
Aging (First Year)	@ +25°C ±3°C			±5	ppm

EQUIVALENT SERIES RESISTANCE/MODE OF OSCILLATION

Frequency (MHz)	ESR Ω Max.	Mode of Osc.
3.57 ~ 4.999	150	Fundamental
5.000 ~ 5.999	80	Fundamental
6.000 ~ 6.999	70	Fundamental
7.000 ~ 8.999	60	Fundamental
9.000 ~ 12.999	50	Fundamental
13.000 ~ 19.999	40	Fundamental
20.000 ~ 40.000	30	Fundamental
40.000 ~ 70.000	80	3 rd Overtone

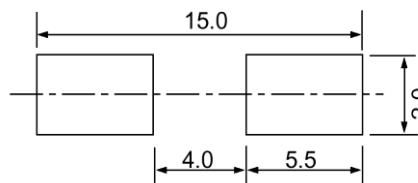

Figure 2) Suggested land

PART NUMBERING GUIDE: Example ECS-200-20-5PXDN-TR

ECS -	FREQUENCY ABBREVIATION	LOAD CAPACITANCE	PACKAGE	Stability	Temperature	PACKAGING
ECS	200 = 20.000 MHz See P/N Guide	20 = 20 pF 10 = 10 pF S = Series	5PX = 4.3 mm	D = ±100 ppm	N = -40 ~ +85°C	TR = Tape & Reel 1K/Reel

POCKET TAPE DIMENSIONS (mm)



A	B	C	D	F	J	L	M	Reel Dia.	Qty/Reel
15.4	5.3	24.0	11.5	12.0	1.7	0.4	4.4	300	1000pcs

SOLDER PROFILE

Peak solder Temp +260°C Max 10 sec Max.

2 Cycles Max.

MSL 1, Lead Finish Sn/Cu Matte

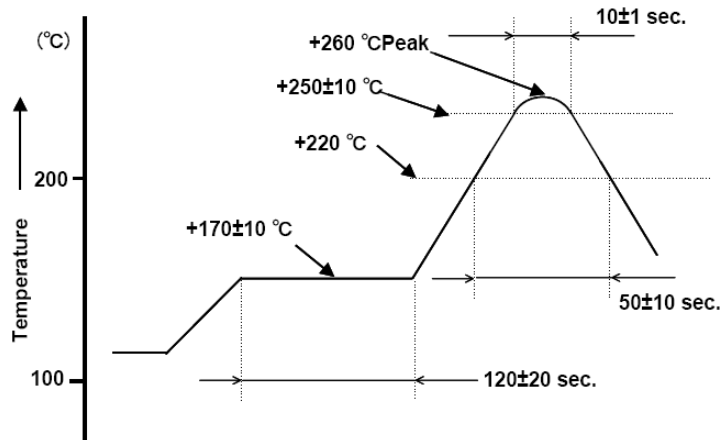



Figure 1) Suggested Reflow Profile

Looking for pricing, stock, or lifecycle information?

Click below to explore more details on WIN SOURCE:

-  [View ECS-120-20-5PXDN-TR on WIN SOURCE](#)
-  [ECS Inc. Information](#)

Optimize Your Supply Chain with WIN SOURCE Solutions

-  Global Sourcing Solution
-  Obsolete Management
-  Cost Control Management
-  Shortage Management
-  Alternative Solution
-  Excess Inventory Management