



**THE DATASHEET OF  
WR06X4302FTL**



# APPROVAL SHEET

**WR10, WR12, WR08, WR06, WR04**

**$\pm 1\%$ ,  $\pm 5\%$ , Jumper**

Thick Film General Purpose Chip Resistors

Size 1210, 1206, 0805, 0603, 0402

RoHS 2 Compliant with exemption 7C-I

Halogen free



\*Contents in this sheet are subject to change without prior notice.

## FEATURE

1. High reliability and stability
2. Reduced size of final equipment
3. Lower assembly costs
4. Higher component and equipment reliability
5. RoHS 2 compliant with exemption 7C-I and Halogen free products
6. Flammability against UL94-V0

## APPLICATION

- Consumer electrical equipment
- EDP, Computer application
- Telecom application

## DESCRIPTION

The resistors are constructed in a high grade ceramic body (aluminum oxide). Internal metal electrodes are added at each end and connected by a resistive paste that is applied to the top surface of the substrate. The composition of the paste is adjusted to give the approximate resistance required and the value is trimmed to within tolerance by laser cutting of this resistive layer.

The resistive layer is covered with a protective coat. Finally, the two external end terminations are added. For ease of soldering the outer layer of these end terminations is a Tin (lead free) alloy.



Fig 1. Construction of Chip-R

## QUICK REFERENCE DATA

Item	General Specification				
	WR10	WR12	WR08	WR06	WR04
Series No.	WR10	WR12	WR08	WR06	WR04
Size code	1210(3225)	1206(3216)	0805(2012)	0603(1608)	0402(1005)
Resistance Range	1Ω~10MΩ (±5% tolerance), 1Ω~10MΩ (±1% tolerance),				
Resistance Tolerance	±1%, E96/E24 ±5%, E24				
TCR (ppm/°C) 10MΩ ≥R > 10Ω R ≤ 10Ω	≤ ± 100 -200~+400				
Max. dissipation @ T <sub>amb</sub> =70°C	1/3 W	1/4 W	1/8 W	1/10 W	1/16 W
Max. Operation Voltage	200V	200V	150V	75V	50V
Max. Overload Voltage	400V	400V	300V	150V	100V
Operation temperature	-55 ~ +155°C				

Note :

1. This is the maximum voltage that may be continuously supplied to the resistor element, see "IEC publication 60115-8"
2. Max. Operation Voltage : So called RCWV (Rated Continuous Working Voltage) is determined by

$$RCWV = \sqrt{\text{Rated Power} \times \text{Resistance Value}} \text{ or Max. RCWV listed above, whichever is lower.}$$

### For Jumper (0Ω) :

Item	General Specification					
	WR10	WR12	WR08	WR06	WR04	
Series No.	WR10	WR12	WR08	WR06	WR04	
Size code	1210(3225)	1206(3216)	0805(2012)	0603(1608)	0402(1005)	
Resistance Range	≤50mΩ for P tolerance ≤30mΩ for F tolerance					
TCR (ppm/°C)	TCR is not applicable for Jumper product					
Max. dissipation @ T <sub>amb</sub> =70°C	1/3 W	1/4 W	1/8 W	1/10 W	1/16 W	
P tolerance	Rated Current	2.5A	2A	1.6A	1A	1A
	Peak Current	6A	5A	3.2A	3A	2A
F tolerance	Rated Current	3.3A	2.9A	2A	1.8A	1A
	Peak Current	6.6A	5.8A	4A	3.6A	2A
Operation temperature	-55 ~ +155°C					

### DIMENSIONS (unit : mm)

	WR10	WR12	WR08	WR06	WR04
L	3.10 ± 0.10	3.10 ± 0.10	2.00 ± 0.10	1.60 ± 0.10	1.00 ± 0.05
W	2.60 ± 0.10	1.60 ± 0.10	1.25 ± 0.10	0.80 ± 0.10	0.50 ± 0.05
T	0.55 ± 0.10	0.55 ± 0.10	0.50 ± 0.15	0.45 ± 0.15	0.35 ± 0.05
Tb	0.50 ± 0.20	0.45 ± 0.20	0.40 ± 0.20	0.30 ± 0.15	0.25 ± 0.10
Tt	0.50 ± 0.20	0.50 ± 0.20	0.40 ± 0.20	0.30 ± 0.10	0.20 ± 0.10

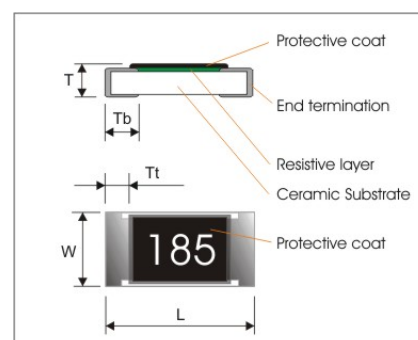

## CATALOGUE NUMBERS

The resistors have a catalogue number starting with

WR12	X	472_	J	T	L
<b>Size code</b>	<b>Type code</b>	<b>Resistance code</b>	<b>Tolerance code</b>	<b>Packaging code</b>	<b>Termination code</b>
<b>WR10</b> : 1210 <b>WR12</b> : 1206 <b>WR08</b> : 0805 <b>WR06</b> : 0603 <b>WR04</b> : 0402	<b>X</b> : Jumper ±5% tol. 1Ω ~ 10MΩ ±1% tol. 10Ω ~ 1MΩ  <b>W</b> : ±1% tol. 1Ω<R<10Ω ±1% tol. 1MΩ<R<10MΩ	±5%,E24: 2 significant digits followed by no. of zeros and a blank 4.7Ω=4R7_ 10Ω=100_ 220Ω=221_  ±1%,E24+E96: 3 significant digits followed by no. of zeros 102Ω=1020 37.4KΩ=3742 82Ω=82R0  <b>For Jumper (0Ω)</b> P tol. ≤ 50mΩ=000_ F tol. ≤ 30mΩ=0000 Remark: “_” means a blank	<b>F</b> : ±1% <b>J</b> : ±5%  <b>For Jumper (0Ω)</b> <b>P</b> : ≤ 50mΩ <b>F</b> : ≤ 30mΩ	<b>T</b> :7" Reeled taping <b>Q</b> :10" Reeled taping <b>G</b> :13" Reeled taping <b>H</b> :13" reel 50Kpcs only for 0402 <b>B</b> :Bulk <b>D</b> :7" reel 20Kpcs only for 0402 <b>A</b> :7" reel 15Kpcs only for 0402	<b>L</b> :Sn base (lead-free)

Remark:

1210, 1206, 0805, 0603:

1. 8mm width paper taping 5000pcs per 7" reel, 10kpcs per 10" reel, 20kpcs per 13" reel.
2. Bulk packaging: 5000pcs per poly-bag

0402:

1. 8mm width paper taping 10,000pcs per 7" reel, 70kpcs per 13" reel.
2. Bulk packaging: 5000pcs per poly-bag

## MARKING

Size \ Nr. Of digit of code\tolerance	±5% & Jumper (0Ω)	±1%
1210 (3225)	3 digits marking	4 digits marking
1206 (3216)	3 digits marking	4 digits marking
0805 (2012)	3 digits marking	4 digits marking
0603 (1608)	3 digits marking	3 digits marking
0402 (1005)	NO MARKING	

### 3 digits marking 【5% : 1210,1206, 0805, 0603 & Jumper (0Ω)】

Each resistor is marked with a three digits code on the protective coating to designate the nominal resistance value.

### 3 digits marking (±1% : 0603)

Nominal resistance	Description														
1.E-24 series	As 0603 WR06X ±5%.														
2.E-96 series	The 1st two digit codes are referring to the CODE on the table, the 3rd code is the index of resistance value : Y=10 <sup>-2</sup> , X=10 <sup>-1</sup> , A=10 <sup>0</sup> , B=10 <sup>1</sup> , C=10 <sup>2</sup> , D=10 <sup>3</sup> , E=10 <sup>4</sup> , F=10 <sup>5</sup> EX : 17.8Ω=25X, 178Ω=25A, 1K78 =25B 17K8=25C, 178K=25D, 1M78=25E														
3. Remark	There is no marking for the items are not under E-24 and E-96 series														
CODE	R_value	CODE	R_value	CODE	R_value	CODE	R_value	CODE	R_value	CODE	R_value	CODE	R_value	CODE	R_value
01	100	13	133	25	178	37	237	49	316	61	422	73	562	85	750
02	102	14	137	26	182	38	243	50	324	62	432	74	576	86	768
03	105	15	140	27	187	39	249	51	332	63	442	75	590	87	787
04	107	16	143	28	191	40	255	52	340	64	453	76	604	88	806
05	110	17	147	29	196	41	261	53	348	65	464	77	619	89	825
06	113	18	150	30	200	42	267	54	357	66	475	78	634	90	845
07	115	19	154	31	205	43	274	55	365	67	487	79	649	91	866
08	118	20	158	32	210	44	280	56	374	68	499	80	665	92	887
09	121	21	162	33	215	45	287	57	383	69	511	81	681	93	909
10	124	22	165	34	221	46	294	58	392	70	523	82	698	94	931
11	127	23	169	35	226	47	301	59	402	71	536	83	715	95	953
12	130	24	174	36	232	48	309	60	412	72	549	84	732	96	976

### 4 digits marking (±1% : 1210,1206,0805)

Each resistor is marked with a four digits code on the protective coating to designate the nominal resistance value.

#### Example

RESISTANCE	Jumper (0Ω)	10Ω	12Ω	100Ω	6800Ω	47000Ω
3 digits marking ( 1210, 1206, 0805, 0603 ±5% & Jumper )	000	100	120	101	682	473
4 digits marking	-	10R0	12R0	1000	6801	4702

## FUNCTIONAL DESCRIPTION

### Product characterization

Standard values of nominal resistance are taken from the E24 series for resistors with a tolerance of  $\pm 5\%$ , and E96 series for resistors with a tolerance of  $\pm 1\%$ . The values of the E24/E96 series are in accordance with "IEC publication 60063"

### Derating

The power that the resistor can dissipate depends on the operating temperature; see Fig.2



Figure 2 Maximum dissipation in percentage of rated power as a function of the ambient temperature

## MOUNTING

Due to their rectangular shapes and small tolerances, Surface Mountable Resistors are suitable for handling by automatic placement systems.

Chip placement can be on ceramic substrates and printed-circuit boards (PCBs).

Electrical connection to the circuit is by individual soldering condition.

### Storage and Handling Conditions:

1. Products are recommended to be used up within two years since operation date as ensured shelf life. Check solderability in case shelf life extension is needed.
2. To store products with following condition:
  - Temperature :5 to 40°C
  - Humidity :20 to 70% relative humidity
3. Caution:
  - a. Don't store products in a corrosive environment such as sulfide, chloride gas, or acid.
    - It may cause oxidization of electrode, which easily be resulted in poor soldering
  - b. To store products on the shelf and avoid exposure to moisture.
  - c. Don't expose products to excessive shock, vibration, direct sunlight and so on

### SOLDERING CONDITION follows J-STD-020D

The robust construction of chip resistors allows them to be completely immersed in a solder bath of 260°C for 10 seconds. Therefore, it is possible to mount Surface Mount Resistors on one side of a PCB and other discrete components on the reverse (mixed PCBs).

Surface Mount Resistors are tested for solderability at 235°C during 2 seconds. The test condition for no leaching is 260°C for 30 seconds.

Typical examples of soldering processes that provide reliable joints without any damage are given in Fig 3.



Fig 3. Recommended IR reflow soldering profile for SMT process with SnAgCu series solder paste

## TEST AND REQUIREMENTS

Essentially all tests are carried out according to the schedule of IEC publication 115-8, category **LCT/UCT/56**(rated temperature range : **Lower Category Temperature, Upper Category Temperature**; damp heat, long term, 56 days). The testing also meets the requirements specified by EIA, EIAJ and JIS.

The tests are carried out in accordance with IEC publication 68, "Recommended basic climatic and mechanical robustness testing procedure for electronic components" and under standard atmospheric conditions according to IEC 60068-1, subclause 5.3. Unless otherwise specified, the following value supplied :

Temperature: 15°C to 35°C.

Relative humidity: 45% to 75%.

Air pressure: 86kPa to 106 kPa (860 mbar to 1060 mbar).

All soldering tests are performed with mildly activated flux.

TEST	PROCEDURE / TEST METHOD	REQUIREMENT	
		Resistor	0Ω
Electrical Characteristics JISC5201-1: 1998 Clause 4.8	- DC resistance values measurement - Temperature Coefficient of Resistance (T.C.R) Natural resistance change per change in degree centigrade. $\frac{R_2 - R_1}{R_1(t_2 - t_1)} \times 10^6 \text{ (ppm/}^\circ\text{C)}$ $t_1 : 20^\circ\text{C}+5^\circ\text{C}-1^\circ\text{C}; t_2 : -55^\circ\text{C or }+155^\circ\text{C}$ $R_1$ : Resistance at reference temperature (20°C+5°C/-1°C) $R_2$ : Resistance at test temperature (-55°C or +155°C)	Within the specified tolerance Refer to "QUICK REFERENCE DATA"	<50mΩ
Resistance to soldering heat(R.S.H) JISC5201-1:1998 Clause 4.18	Un-mounted chips completely immersed for 10±1second in a SAC solder bath at 260°C±5°C	±5%:ΔR/Rmax.±(1%+0.05Ω) ±1%:ΔR/Rmax.±(0.5%+0.05Ω) no visible damage	<50mΩ
Solderability JISC5201-1:1998 Clause 4.17	Un-mounted chips completely immersed for 2±0.5 second in a SAC solder bath at 235°C±5°C	95% coverage min., good tinning and no visible damage	
Temperature cycling JISC5201-1:1998 Clause 4.19	30 minutes at -55°C±3°C, 2~3 minutes at 20°C+5°C-1°C, 30 minutes at +155°C±3°C, 2~3 minutes at 20°C+5°C-1°C, total 5 continuous cycles	±5%: ΔR/R max. ±(1%+0.05Ω) ±1%:ΔR/Rmax.±(0.5%+0.05Ω) No visible damage	<50mΩ
High Temperature Exposure MIL-STD-202 method 108	1000+48/-0 hours; without load in a temperature chamber controlled 155±3°C	±5%:ΔR/Rmax.±(2%+0.1Ω) ±1%:ΔR/Rmax.±(1%+0.1Ω) No visible damage	<50mΩ

TEST	PROCEDURE / TEST METHOD	REQUIREMENT	
		Resistor	0Ω
Bending strength JISC5201-1:1998 Clause 4.33	Resistors mounted on a 90mm glass epoxy resin PCB(FR4), bending once 3mm for 10sec, 5mm for WR04	±5%:ΔR/Rmax.±(1%+0.05Ω) ±1%:ΔR/Rmax.±(1%+0.05Ω) No visual damaged	<50mΩ
Adhesion JISC5201-1:1998 Clause 4.32	Pressurizing force: 5N, Test time: 10±1sec.	No remarkable damage or removal of the terminations	
Short Time Overload (STOL) JISC5201-1:1998 Clause 4.13	2.5 times RCWV or max. overload voltage, for 5seconds	±5%: ΔR/R max. ±(2%+0.05Ω) ±1%: ΔR/R max. ±(1%+0.05Ω) No visible damage	<50mΩ
Load life in Humidity JISC5201-1:1998 Clause 4.24	1000 +48/-0 hours, loaded with RCWV or Vmax in humidity chamber controller at 40°C±2°C and 90~95% relative humidity, 1.5hours on and 0.5 hours off	±5%: ΔR/R max. ±(2%+0.1Ω) ±1%: ΔR/R max. ±(1%+0.1Ω) No visible damage	<50mΩ
Load life (endurance) JISC5201-1:1998 Clause 4.25	1000 +48/-0 hours, loaded with RCWV or Vmax in chamber controller 70±2°C, 1.5 hours on and 0.5 hours off	±5%: ΔR/R max. ±(3%+0.1Ω) ±1%: ΔR/R max. ±(1%+0.1Ω) No visible damage	<50mΩ
Insulation Resistance JISC5201-1:1998 Clause 4.6	Apply the maximum overload voltage (DC) for 1minute	R ≥ 10GΩ	
Dielectric Withstand Voltage JISC5201-1:1998 Clause 4.7	Apply the maximum overload voltage (AC) for 1 minute	No breakdown or flashover	

## PACKAGING

### Paper Tape specifications (unit :mm)

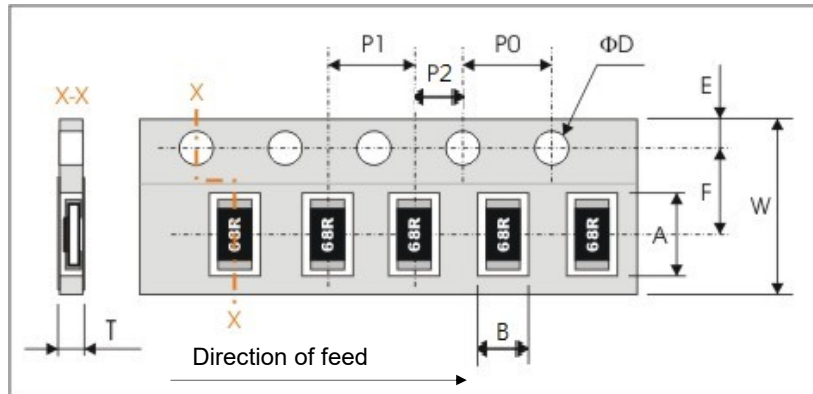

Series No.	A	B	W	F	E
WR10	3.60±0.20	3.00±0.20	8.00±0.30	3.50±0.20	1.75±0.10
WR12	3.60±0.20	2.00±0.20			
WR08	2.40±0.20	1.65±0.20			
WR06	1.90±0.20	1.10±0.20			
WR04	1.20±0.10	0.70±0.10			

Series No.	P1	P0	P2	ΦD	T
WR10/12/08	4.00±0.10	4.00±0.10	2.00±0.10	Φ1.50 <sup>+0.1</sup> <sub>-0.0</sub>	0.80±0.1
WR06					0.70±0.05
WR04	2.00±0.10	0.50±0.05			

### Reel dimensions



Symbol	A	B	C	D
7" reel	Φ178.0±2.0	Φ60.0±1.0	13.0±0.2	9.0±0.5
10" reel	Φ254.0±2.0	Φ100.0±1.0	13.0±0.2	9.0±0.5
13" reel	Φ330.0±2.0	Φ100.0±1.0	13.0±0.2	9.0±0.5

## Looking for pricing, stock, or lifecycle information?

Click below to explore more details on WIN SOURCE:

- ⊖ [View WR06X4302FTL on WIN SOURCE](#)
- ⊖ [Walsin Technology Corporation Information](#)

## Optimize Your Supply Chain with WIN SOURCE Solutions

- ✓ Global Sourcing Solution
- ✓ Obsolete Management
- ✓ Cost Control Management
- ✓ Shortage Management
- ✓ Alternative Solution
- ✓ Excess Inventory Management