



**THE DATASHEET OF
MAX14523BATA+T**



Click [here](#) for production status of specific part numbers.

MAX14523A/MAX14523AL/ MAX14523B/MAX14523C

250mA to 1.5A, Adjustable Current-Limit Switches

General Description

The MAX14523A/MAX14523AL/MAX14523B/MAX14523C programmable current-limit switches feature internal current limiting to prevent damage to host devices due to faulty load conditions. These current-limit switches feature a low 70mΩ on-resistance and operate from a +1.7V to +5.5V input voltage range. The current limit is adjustable from 250mA to 1.5A, making these devices ideal for SDIO (secure digital input/output) and other load-switching applications.

Each device in the family handles an overcurrent event differently depending on the option selected. The MAX14523A/MAX14523AL go into an autoretry mode, the MAX14523B latches off the switch, and the MAX14523C features a continuous current-limit mode. Additional safety features include thermal shutdown to prevent overheating and reverse-current blocking to prevent current from being driven back into the source.

The MAX14523A/MAX14523AL/MAX14523B/MAX14523C are available in a tiny 8-pin, 3mm x 3mm, TDFN package and operate over the -40°C to +125°C automotive temperature range.

Applications

- SDIO Ports
- USB Ports
- Notebook VGA Ports
- GPS
- Cell Phones
- MP3 Players
- UTCA/ATCA Platforms

Benefits and Features

- Accurate ($\pm 10\%$) Overload Current Limit
- Adjustable Current-Limit Threshold
- Low-Dropout Voltage (70mV at 1A Load Current)
- Short-Circuit Protection
- Thermal-Shutdown Protection
- Reverse-Current Protection
- 170μA (typ) Supply Current
- Shutdown Reverse Current, 0.6μA (max)
- +1.7V to +5.5V Supply Voltage Range
- Tiny 8-Pin, 3mm x 3mm, TDFN Package

Typical Operating Circuit

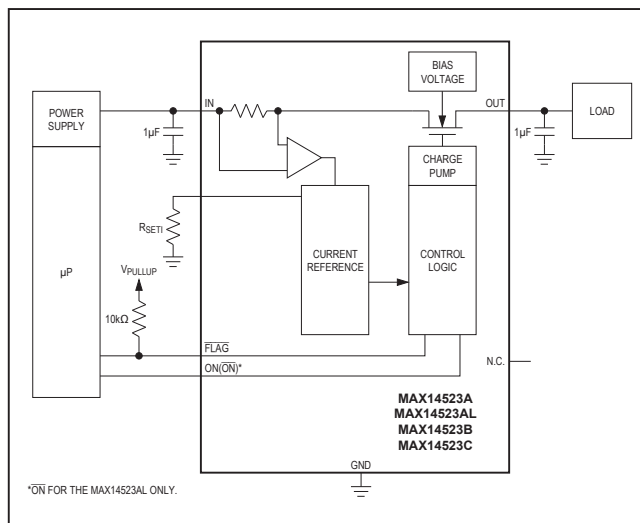

Ordering Information/Selector Guide appears at end of data sheet.

MAX14523A/MAX14523AL/
MAX14523B/MAX14523C

250mA to 1.5A, Adjustable
Current-Limit Switches

Absolute Maximum Ratings

(All voltages referenced to GND.)
 IN, ON, ON, FLAG, OUT, and SET1 to GND.....-0.3V to +6V
 Current into Any Pin (Except IN, OUT)20mA
 Out Short Circuit to GND.....Internally Limited
 Continuous Power Dissipation (T_A = +70°C) for multilayer board:
 TDFN (derate 24.4mW/°C above +70°C).....1952mW

Operating Temperature Range..... -40°C to +125°C
 Junction Temperature..... +150°C
 Storage Temperature Range..... -65°C to +150°C
 Lead Temperature (soldering, 10s)+300°C
 Soldering Temperature (reflow).....+260°C

Stresses beyond those listed under "Absolute Maximum Ratings" may cause permanent damage to the device. These are stress ratings only, and functional operation of the device at these or any other conditions beyond those indicated in the operational sections of the specifications is not implied. Exposure to absolute maximum rating conditions for extended periods may affect device reliability.

Package Information

PACKAGE TYPE: 8 TDFN	
Package Code	T833+2
Outline Number	21-0137
Land Pattern Number	90-0059
THERMAL RESISTANCE, FOUR-LAYER BOARD	
Junction to Ambient (θ _{JA})	41°C/W
Junction to Case (θ _{JC})	8°C/W

Package thermal resistances were obtained using the method described in JEDEC specification JESD51-7, using a four-layer board. For detailed information on package thermal considerations, refer to www.maximintegrated.com/thermal-tutorial.

For the latest package outline information and land patterns (footprints), go to www.maximintegrated.com/packages. Note that a "+", "#", or "-" in the package code indicates RoHS status only. Package drawings may show a different suffix character, but the drawing pertains to the package regardless of RoHS status.

Electrical Characteristics

(V_{IN} = +1.7V to +5.5V, R_{SET1} = 94.2kΩ, C_{IN} = C_{OUT} = 1μF, and T_A = T_J = -40°C to +125°C, unless otherwise noted. Typical values are at V_{IN} = +3.3V, T_A = +25°C.) (Note 1)

PARAMETER	SYMBOL	CONDITIONS	MIN	TYP	MAX	UNITS
SUPPLY OPERATION						
Operating Voltage	V _{IN}		1.7		5.5	V
Quiescent Current	I _Q	I _{OUT} = 0A, switch on, V _{IN} = 3.3V		170	300	μA
Latchoff Current	I _{LATCH}	V _{IN} = 3.3V, I _{OUT} = 0A, after an overcurrent fault (MAX14523B)		10	20	μA
Shutdown Forward Current	I _{SHDN}	V _{ON} = 0V, V _{ON} = V _{IN} , V _{IN} = 5.5V, V _{OUT} = 0V		0.5	7	μA
Shutdown Reverse Current	I _{RSHDN}	V _{ON} = 0V, V _{ON} = V _{IN} , V _{IN} = 1.7V, V _{OUT} = 5.5V (current into OUT)		0.01	0.6	μA
INTERNAL FET						
Switch-On Resistance	R _{ON}	V _{IN} = 3.3V, I _{OUT} lower than I _{LIM}		70	130	mΩ
Forward-Current Limit	I _{LIM}	R _{SET1} = 91.78kΩ, V _{IN} - V _{OUT} = 1V	1350	1500	1650	mA
		R _{SET1} = 563.12kΩ, V _{IN} - V _{OUT} = 1V	225	250	275	
(R _{SET1} + 2.48kΩ) x I _{LIM} Product		I _{LIM} = 250mA to 1500mA, V _{IN} - V _{OUT} = 1V	127.2	141.4	155.5	kV
Reverse Blocking Current		V _{OUT} > V _{IN} + 140mV, after reverse-current-limit shutdown			2	μA

Electrical Characteristics (continued)

($V_{IN} = +1.7V$ to $+5.5V$, $R_{SET1} = 94.2k\Omega$, $C_{IN} = C_{OUT} = 1\mu F$, and $T_A = T_J = -40^\circ C$ to $+125^\circ C$, unless otherwise noted. Typical values are at $V_{IN} = +3.3V$, $T_A = +25^\circ C$.) (Note 1)

PARAMETER	SYMBOL	CONDITIONS	MIN	TYP	MAX	UNITS
Reverse Blocking Threshold	$V_{OUT} - V_{IN}$	$V_{OUT} - V_{IN} = 300mV$, OUT falling until switch turns on	40	95	140	mV
FLAG Assertion Drop Voltage Threshold	V_{FA}	Increase ($V_{IN} - V_{OUT}$) drop until \overline{FLAG} asserts, I_{OUT} limiting, $V_{IN} = 3.3V$		350		mV
ON, \overline{ON} INPUT						
ON, \overline{ON} Input Leakage	I_{LEAK}	V_{ON} , $\overline{V_{ON}} = V_{IN}$ or V_{GND}	-1		+1	μA
ON, \overline{ON} Input Logic-High Voltage	V_{IH}		1.6			V
ON, \overline{ON} Input Logic-Low Voltage	V_{IL}				0.4	V
FLAG OUTPUT						
FLAG Output Logic-Low Voltage		$I_{SINK} = 1mA$			0.4	V
FLAG Output Leakage Current		$V_{IN} = V_{FLAG} = 5.5V$, \overline{FLAG} deasserted			1	μA
DYNAMIC						
Turn-On Time	t_{SS}	Time from ENABLE signal to $V_{OUT} = 90\%$ of $V_{IN} = 3.3V$, Figure 1		1		ms
Turn-Off Time	t_{OFF}	Time from DISABLE signal to $V_{OUT} = 10\%$ of $V_{IN} = 3.3V$, $R_L = 20\Omega$, Figure 1		250		μs
Current-Limit Reaction Time	t_{LIM}	$V_{IN} = 3.3V$, $R_{SET1} = 91.78k\Omega$ to $563.12k\Omega$, output high and then short-circuit applied		3		μs
Blanking Time	t_{BLANK}	(Note 3)	10	14.5	25	ms
Retry Time	t_{RETRY}	MAX14523A/MAX14523AL (Note 2)	320		875	ms
THERMAL PROTECTION						
Thermal Shutdown		Low-to-high		+170		$^\circ C$
Thermal Shutdown Hysteresis				15		$^\circ C$

Note 1: All devices are 100% tested at $125^\circ C$. Electrical limits across the full temperature range are guaranteed by design and correlation.

Note 2: Blanking time and retry time are generated by the same oscillator. Therefore, the ratio of $\frac{t_{RETRY}}{t_{BLANK}}$ is a constant value of 32. See Figures 2 and 3.

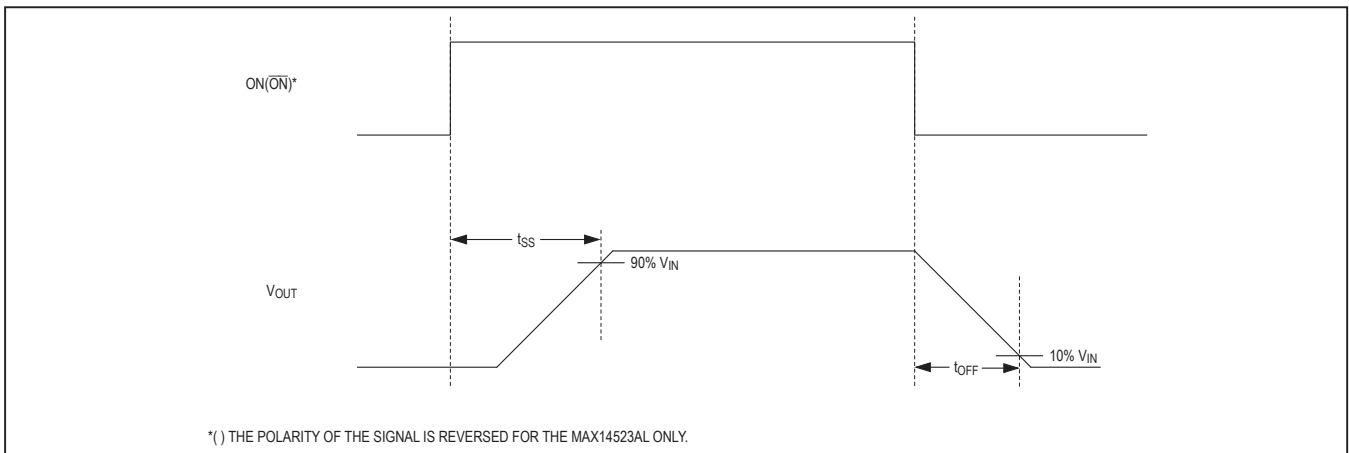

Figure 1. Timing Diagram for Measuring Turn-On Time (t_{SS}) and Turn-Off Time (t_{OFF})

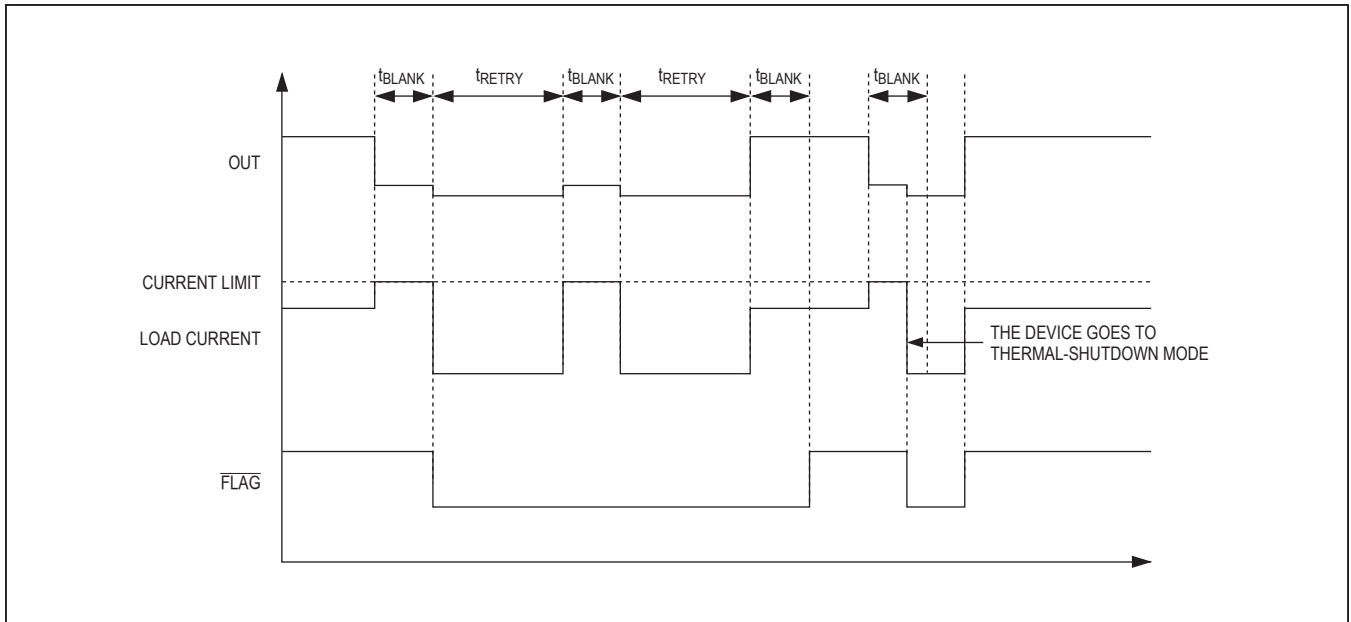

Figure 2. Autoretry Fault Diagram

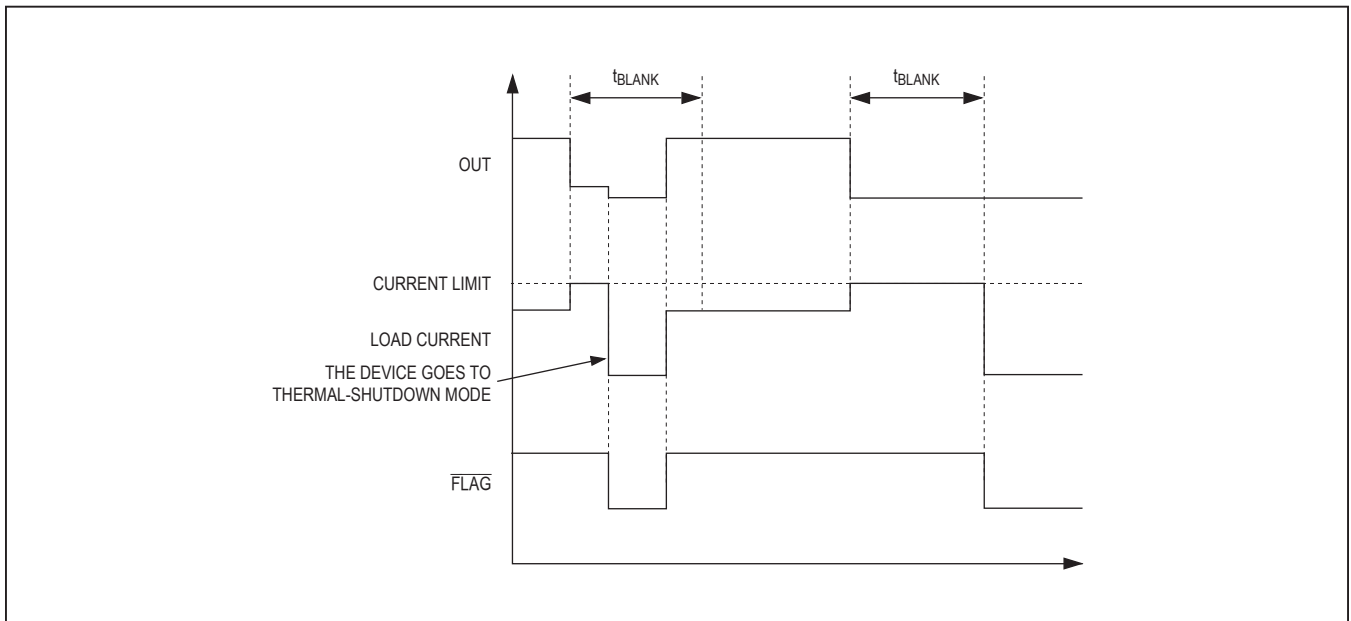
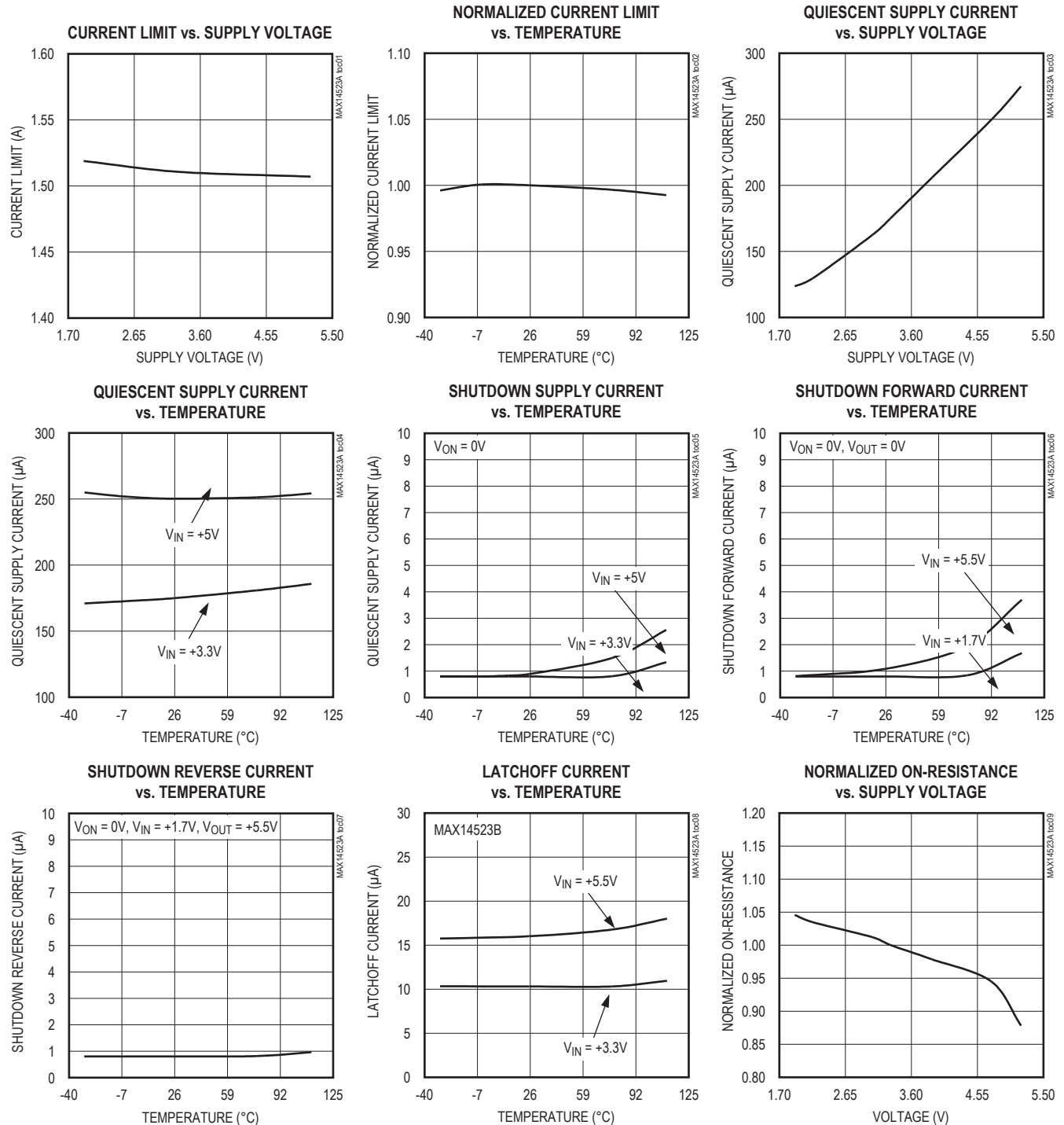

Figure 3. Latchoff Fault Diagram

Typical Operating Characteristics

($V_{IN} = +3.3V$, $C_{IN} = 1\mu F$, $C_{OUT} = 1\mu F$, $R_{SET1} = 94.2k\Omega$, $T_A = +25^\circ C$, unless otherwise noted.)



Typical Operating Characteristics (continued)

($V_{IN} = +3.3V$, $C_{IN} = 1\mu F$, $C_{OUT} = 1\mu F$, $R_{SET1} = 94.2k\Omega$, $T_A = +25^\circ C$, unless otherwise noted.)

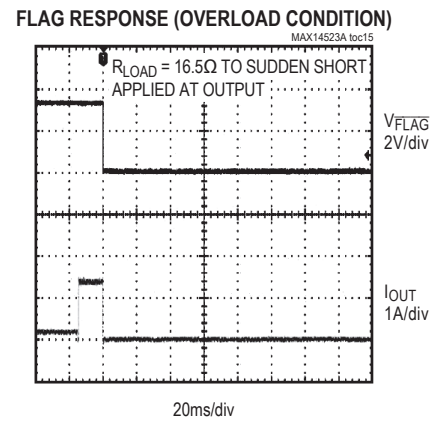
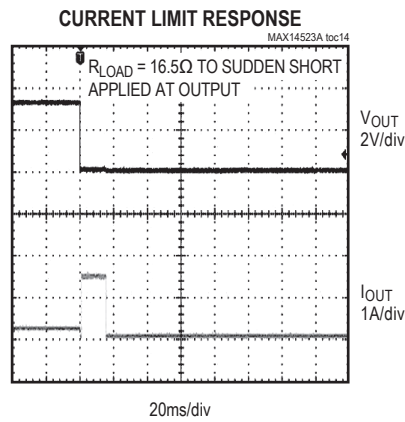
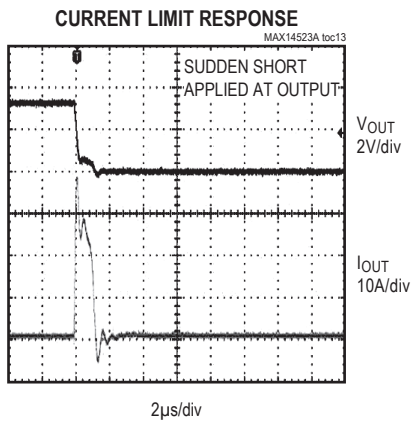
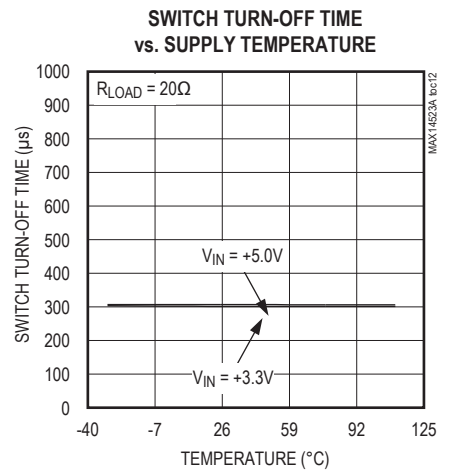
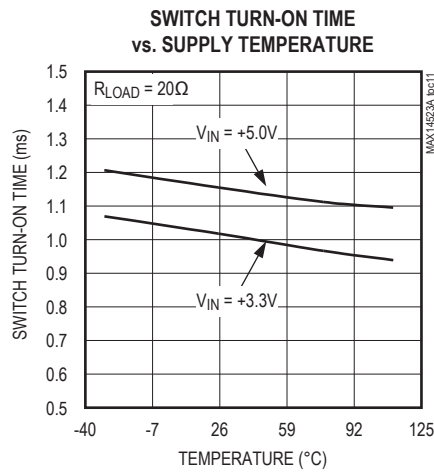
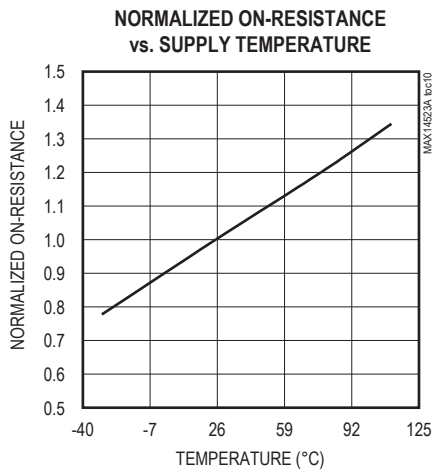

Pin Configuration

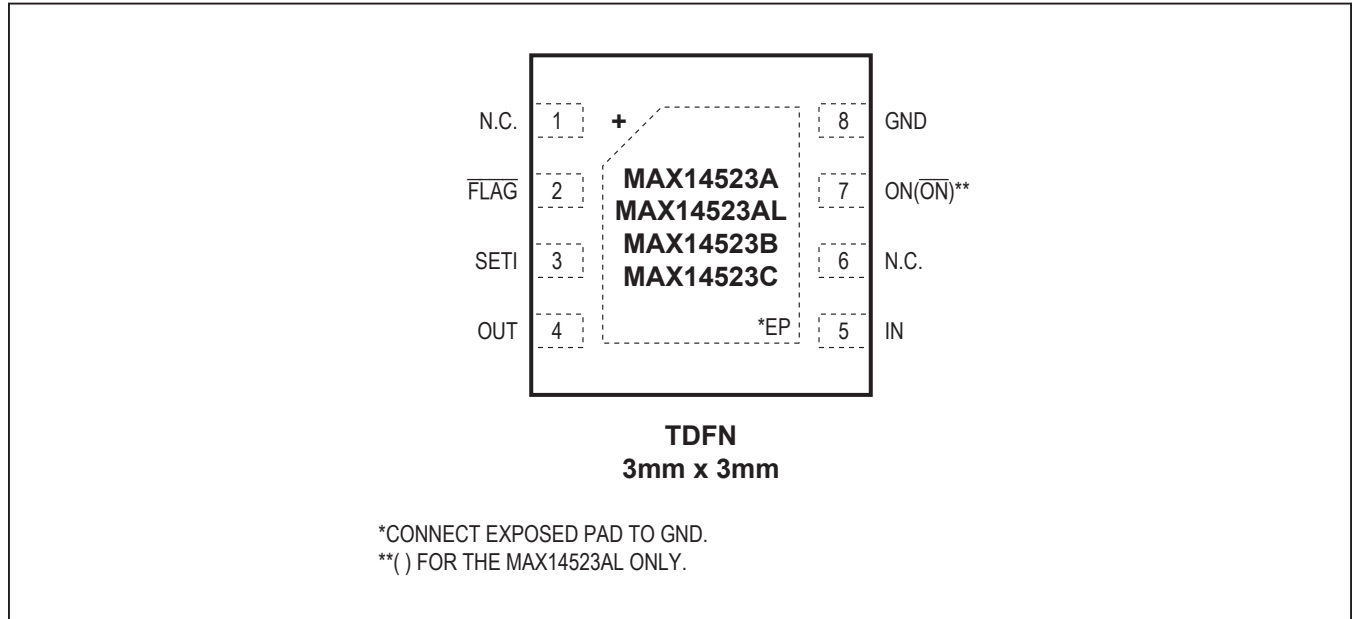

Pin Description

PIN		NAME	FUNCTION
MAX14523AL	MAX14523A MAX14523B MAX14523C		
1, 6	1, 6	N.C.	No Connection. Not internally connected. Connect N.C. to GND or leave unconnected.
2	2	FLAG	Open-Drain, Overload Indicator Output. FLAG goes low when the overload fault duration exceeds the blanking time, reverse current is detected, thermal shutdown mode is active, or SETI is connected to ground.
3	3	SETI	Overload-Current Limit Adjust. Connect a resistor from SETI to GND to program the overcurrent limit. If SETI is connected to GND the switch turns off and FLAG is asserted. If SETI is unconnected the current limit is at 0mA. Do not connect any capacitance larger than 20pF to SETI.
4	4	OUT	Switch Output. Bypass OUT with a 1µF capacitor to GND.
5	5	IN	Power Input. Bypass IN with a 1µF ceramic capacitor to GND. Use higher capacitance if necessary to prevent large load transients from pulling down the supply voltage.
7	—	ON	Active-Low, Switch-ON Input. Drive ON low to turn on the switch.
—	7	ON	Active-High, Switch-ON Input. Drive ON high to turn on the switch.
8	8	GND	Ground
—	—	EP	Exposed Pad. Internally connected to GND. For enhanced thermal dissipation, connect EP to a large copper ground plane. Do not use EP as the sole ground connection.

Functional Diagram

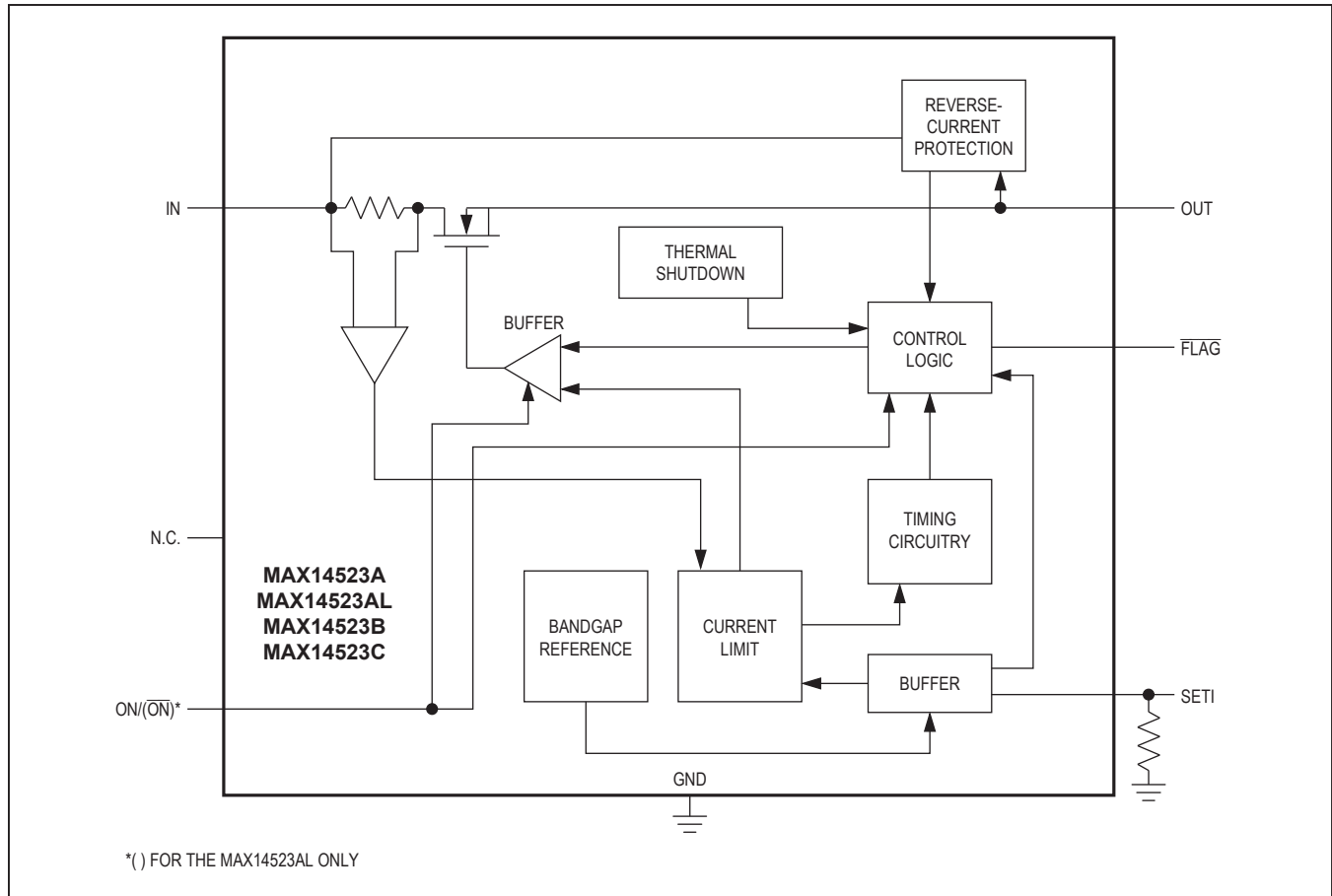

Detailed Description

The MAX14523A/MAX14523AL/MAX14523B/MAX14523C programmable current-limit switches operate from +1.7V to +5.5V and provide internal current limiting adjustable from 250mA to 1.5A. These devices feature a fixed blanking time, and a $\overline{\text{FLAG}}$ output that notifies the processor when a fault condition is present.

Programmable Current Limit/Threshold

A resistor from SET1 to GND sets the current limit/threshold for the switch (see the *Setting the Current Limit/Threshold* section). If the output current is limited at the current threshold value for a time equal to or longer than t_{BLANK} , the output flag asserts and the MAX14523A/MAX14523AL enter the autoretry mode, the MAX14523B latches off the switch, and the MAX14523C enters the continuous current-limit mode.

Autoretry (MAX14523A/MAX14523AL)

When the forward current reaches the current threshold, the t_{BLANK} timer begins counting (Figure 2). $\overline{\text{FLAG}}$ asserts if the overcurrent condition is present for t_{BLANK} or longer. The timer resets if the overcurrent condition disappears before the blanking time (t_{BLANK}) has elapsed. A retry time delay (t_{RETRY}) starts immediately after the blanking time has elapsed. During that time, the switch latches off. At the end of t_{RETRY} , the switch turns on again. If the fault still exists, the cycle repeats. If the fault has been removed, the switch stays on. During this cycle, $\overline{\text{FLAG}}$ stays low. In autoretry, if the die temperature exceeds +170°C (typ) due to self heating, the MAX14523A/MAX14523AL go into thermal shutdown until the die temperature drops by approximately 15°C (see the *Thermal Shutdown* section.)

The autoretry feature saves system power in case of an overcurrent or short-circuit condition. During t_{BLANK} time, when the switch is on, the supply current is held at the current limit. During time t_{RETRY} , when the switch is off, the current through the switch is zero. Thus, the average output current is much less than the programmed current limit. Calculate the average output current using the following equation:

$$I_{LOAD} = I_{LIM} [(t_{BLANK}) / (t_{BLANK} + t_{RETRY})]$$

With a typical $t_{BLANK} = 17.5\text{ms}$ and typical $t_{RETRY} = 560\text{ms}$, the duty cycle is 3%, resulting in a 97% power savings over the switch being on the entire time.

Latchoff (MAX14523B)

When the forward current reaches the current threshold, the t_{BLANK} timer begins counting (Figure 3). \overline{FLAG} asserts if an overcurrent condition is present for greater than t_{BLANK} time. The timer resets if the overcurrent condition disappears before t_{BLANK} has elapsed. The switch turns off if the overcurrent condition continues beyond the blanking time. Reset the switch by either toggling the control logic (ON or \overline{ON}) or cycling the input voltage. If the die temperature exceeds $+170^\circ\text{C}$ (typ) due to self heating, the MAX14523B goes into thermal shutdown until the die temperature drops by approximately 15°C (see the *Thermal Shutdown* section).

Continuous Current Limit (MAX14523C)

When the forward current reaches the forward-current threshold, the MAX14523C limits the output current to the programmed current limit. \overline{FLAG} asserts if the current limit is present for t_{BLANK} and deasserts when the overload condition is removed. In this mode, if die temperature exceeds $+170^\circ\text{C}$ (typ) due to self heating, the MAX14523C goes into thermal shutdown until the die temperature drops by approximately 15°C (see the *Thermal Shutdown* section).

Table 1. Switch Truth Table

MAX14523A MAX14523B MAX14523C	MAX14523AL	SWITCH STATUS
ON	\overline{ON}	
0	1	Off
1	0	On

Switch-On/Off Control

The ON input for the MAX14523A/MAX14523B/MAX14523C and \overline{ON} input for the MAX14523AL control the switch, see Table 1. Toggle ON for the MAX14523B to reset the fault condition once the short-circuit current is detected and the device shuts down.

Reverse-Current Protection

The MAX14523A/MAX14523AL/MAX14523B/MAX14523C feature a reverse-current protection circuit that limits the backflow current to $2\mu\text{A}$ when the reverse-current protection circuitry has tripped. The switch turns off and \overline{FLAG} asserts without waiting for t_{BLANK} to elapse. The switch turns back on and \overline{FLAG} deasserts when $V_{IN} - V_{OUT}$ drops below the reverse-current threshold by 95mV (typ).

FLAG Indicator

\overline{FLAG} is an open-drain fault indicator output and requires an external pullup resistor to a DC supply. \overline{FLAG} goes low when any of the following conditions occur:

- The blanking time has elapsed
- The reverse-current protection has tripped
- The die temperature exceeds $+170^\circ\text{C}$
- SETI is connected to ground.

Thermal Shutdown

Thermal-shutdown circuitry protects the devices from overheating. The switch turns off and \overline{FLAG} goes low immediately when the junction temperature exceeds $+170^\circ\text{C}$ (typ). The switch turns on again after the device temperature drops by approximately 15°C (typ).

Applications Information

Setting the Current Limit/Threshold

A resistor from SETI to ground programs the current limit/threshold value for the MAX14523A/MAX14523AL/MAX14523B/MAX14523C. Table 2 lists various current limit/thresholds set by different resistor values at SETI. Leaving SETI unconnected selects a 0 current limit/threshold. Connecting SETI to ground asserts \overline{FLAG} .

Use the following formula to calculate the current limit:

$$R_{SETI}(\text{k}\Omega) = \frac{141400(\text{V})}{I_{LIM}(\text{mA})} - 2.48(\text{k}\Omega)$$

Table 2. Current Limit/Threshold vs. Resistor Values

R _{SETI} (kΩ)	TYPICAL CURRENT LIMIT/THRESHOLD (mA)
91.78	1500
121	1145
221	632
301	466
422	333
563.12	250
∞ (Open)	0

Do not use an R_{SETI} value smaller than 91.78kΩ.

Note: Connecting any capacitance larger than 20pF to SETI can cause instability.

IN Bypass Capacitor

Connect a minimum of 1μF capacitor from IN to GND to limit the input voltage drop during momentary output short-circuit conditions. Larger capacitor values further reduce the voltage undershoot at the input.

OUT Bypass Capacitor

For stable operation over the full temperature range and over the full-programmable current-limit range, use a 1μF ceramic capacitor from OUT to ground.

Excessive output capacitance can cause a false over-current condition due to decreased dv/dt across the capacitor.

Calculate the maximum capacitive load (C_{MAX}) value that can be connected to OUT using the following formula:

$$C_{MAX}(\mu F) = \frac{I_{LIM}(mA) \times t_{BLANK}(MIN)(ms)}{V_{IN}(V)}$$

For example, for V_{IN} = 3.3V, t_{BLANK} = 10ms, and I_{LIM} = 300mA, C_{MAX} equals 909μF.

Layout and Thermal Dissipation

To optimize the switch response time to output shortcircuit conditions, it is very important to keep all traces as short as possible to reduce the effect of undesirable parasitic inductance. Place input and output capacitors as close as possible to the device (no more than 5mm). IN and OUT must be connected with wide short traces to the power bus. During normal operation, the power dissipation is small and the package temperature change is minimal. If the output is continuously shorted to ground at the maximum supply voltage, the operation of the switches with the autoretry option does not cause problems because the total power dissipated during the short is scaled by the duty cycle:

$$P_{(MAX)} = \frac{V_{IN(MAX)} \times I_{OUT(MAX)} \times t_{BLANK}}{t_{RETRY} + t_{BLANK}}$$

Attention must be given to the MAX14523C continuous current-limit version when the power dissipation during a fault condition can cause the device to reach the thermal shutdown threshold.

Ordering Information/Selector Guide

PART	PIN-PACKAGE	TOP MARK	ON POLARTIY	OVERCURRENT RESPONSE
MAX14523AATA+	8 TDFN-EP*	BLO	Active-High	Autoretry
MAX14523ALATA+**	8 TDFN-EP*	BLP	Active-Low	Autoretry
MAX14523BATA+	8 TDFN-EP*	BLQ	Active-High	Latch-Off
MAX14523BATA/V+T†	8 TDFN-EP*	BLQ	Active-High	Latch-Off
MAX14523CATA+	8 TDFN-EP*	BLS	Active-High	Continuous

Note: All devices are specified over the -40°C to +125°C operating temperature range.

+Denotes a lead(Pb)-free package/RoHs-compliant package.

/V denotes an automotive qualified part.

† denotes a part that is Not Recommended for New Designs.

*EP = Exposed pad.

**Future product—contact factory for availability.

Chip Information

PROCESS: BiCMOS

MAX14523A/MAX14523AL/
MAX14523B/MAX14523C

250mA to 1.5A, Adjustable
Current-Limit Switches

Revision History



REVISION NUMBER	REVISION DATE	DESCRIPTION	PAGES CHANGED
0	7/09	Initial release	—
1	1/11	Added the MAX14523BATA automotive-grade part to the <i>Ordering Information</i>	1
2	5/19	Updated MAX14523BATA/V+T as Not Recommended for New Designs	10

For pricing, delivery, and ordering information, please visit Maxim Integrated's online storefront at <https://www.maximintegrated.com/en/storefront/storefront.html>.

Maxim Integrated cannot assume responsibility for use of any circuitry other than circuitry entirely embodied in a Maxim Integrated product. No circuit patent licenses are implied. Maxim Integrated reserves the right to change the circuitry and specifications without notice at any time. The parametric values (min and max limits) shown in the Electrical Characteristics table are guaranteed. Other parametric values quoted in this data sheet are provided for guidance.

Looking for pricing, stock, or lifecycle information?

Click below to explore more details on WIN SOURCE:

-  [View MAX14523BATA+T on WIN SOURCE](#)
-  [Analog Devices Inc. Information](#)

Optimize Your Supply Chain with WIN SOURCE Solutions

-  Global Sourcing Solution
-  Obsolete Management
-  Cost Control Management
-  Shortage Management
-  Alternative Solution
-  Excess Inventory Management