



**THE DATASHEET OF  
AMMP-6220-TR2**



# AMMP-6220

## 6-20 GHz Low Noise Amplifier



### Data Sheet



#### Description

Avago's AMMP-6220 is a high gain, low-noise amplifier that operates from 6 GHz to 20 GHz. The LNA is designed to be a easy-to-use component for any surface mount PCB application. The broad and unconditionally stable performance makes this LNA ideal for primary, sub-sequential or driver low noise gain stages. Intended applications include microwave radios, 802.16, automotive radar, VSAT, and satellite receivers. Since one part can cover several bands, the AMMP-6220 can reduce part inventory and increase volume purchase options. The LNA has integrated 50 Ω I/O match, DC blocking, self-bias and choke to eliminate complex tuning and assembly processes typically required by hybrid (discrete-FET) amplifiers. The package is full SMT compatible with backside grounding and I/O to simplify assembly.

#### Features

- 5x5 mm surface mount package
- Broad Band performance 6-20 GHz
- Low 2.5 dB typical noise figure
- High 22 dB typical gain
- 50 Ω input and output match
- Single 3 V (55 mA) supply bias
- 100% RF test in package

#### Applications

- Microwave radio systems
- Satellite VSAT
- WLL and MMDS loops

#### Package Diagram

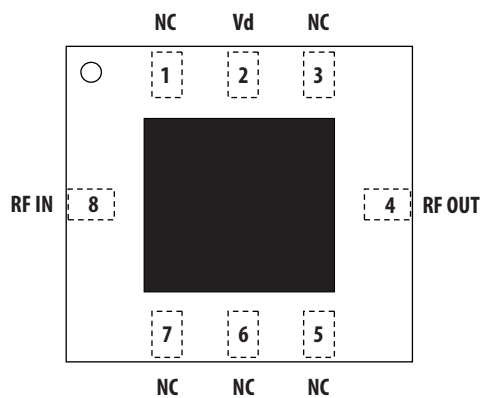

#### Functional Block Diagram

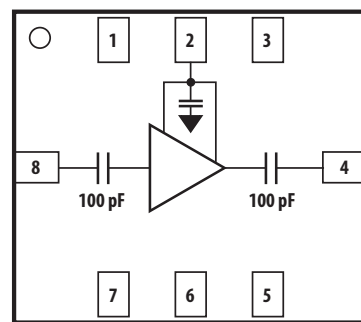

PIN	FUNCTION
1	
2	V <sub>d</sub>
3	
4	RF <sub>out</sub>
5	
6	
7	
8	RF <sub>in</sub>

PACKAGE  
BASE  
GND

#### RoHS-Exemption



Please refer to hazardous substances table on page 7.



**Attention: Observe precautions for handling electrostatic sensitive devices.**  
 ESD Machine Model (Class A) = 40V  
 ESD Human Body Model (Class 1A) = 300V  
 Refer to Avago Application Note A004R: Electrostatic Discharge, Damage and Control.

Note: MSL Rating = Level 2A

## Electrical Specifications

1. Small/Large -signal data measured in a fully de-embedded test fixture form  $T_A = 25^\circ\text{C}$ .
2. Pre-assembly into package performance verified 100% on-wafer per AMMC-6220 published specifications.
3. This final package part performance is verified by a functional test correlated to actual performance at one or more frequencies.
4. Specifications are derived from measurements in a 50 W test environment. Aspects of the amplifier performance may be improved over a more narrow bandwidth by application of additional conjugate, linearity, or low noise ( $\Gamma_{opt}$ ) matching.

**Table 1. RF Electrical Characteristics**

Parameter	Min	Typ.	Max	Sigma	Unit
Small-signal Gain, $G_a$		22		0.5	dB
Noise Figure into 50 $\Omega$ , NF		2.5		0.2	dB
Output Power at 1dB Gain Compression, P-1dB		+10		0.8	dBm
Third Order Intercept Point; $\Delta f=100\text{MHz}$ ; $P_{in}=-20\text{dBm}$ , OIP3		+20		1.1	dBm
Input Return Loss, $R_{Lin}$		-12		0.3	dB
Output Return Loss, $R_{lout}$		-16		0.7	dB
Reverse Isolation, $I_{sol}$		-45		0.5	dB

**Table 2. Recommended Operating Range**

1. Ambient operational temperature  $T_A = 25^\circ\text{C}$  unless otherwise noted.
2. Channel-to-backside Thermal Resistance ( $T_{channel}$  ( $T_c$ ) =  $34^\circ\text{C}$ ) as measured using infrared microscopy. Thermal Resistance at backside temperature ( $T_b$ ) =  $25^\circ\text{C}$  calculated from measured data.

Description	Specifications			Unit	Comments
	Min.	Typical	Max.		
Drain Supply Current, $I_d$		55	70	mA	( $V_d = 3\text{V}$ , Under any RF power drive and temperature)

**Table 3. Thermal Properties**

Parameter	Test Conditions	Value
Thermal Resistance, $\theta_{ch-b}$		$\theta_{ch-b} = 27^\circ\text{C/W}$

## Absolute Minimum and Maximum Ratings

**Table 4. Minimum and Maximum Ratings**

Description	Pin	Specifications			Comments
		Min.	Max.	Unit	
Drain Supply Voltage	$V_d$		7	V	
Drain Current	$I_d$		100	mA	
RF Input Power ( $P_{in}$ )	RFIN		15	dBm	CW
Channel Temperature			+150	$^\circ\text{C}$	
Storage Temperature		-65	+150	$^\circ\text{C}$	
Maximum Assembly Temperature			+300	$^\circ\text{C}$	60 second maximum

Notes:

1. Operation in excess of any one of these conditions may result in permanent damage to this device.

### Selected performance plots

These measurements are in 50Ω test environment at  $T_A = 25^\circ\text{C}$ ,  $V_d = 3\text{V}$ ,  $I_d = 55\text{ mA}$ . Aspects of the amplifier performance may be improved over a narrower bandwidth by application of additional conjugate, linearity or low noise ( $\Gamma_{opt}$ ) matching.

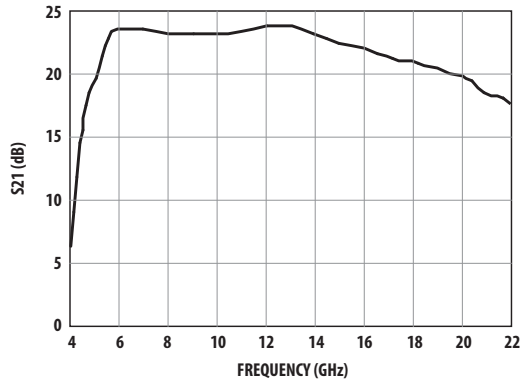

Figure 1. Gain.

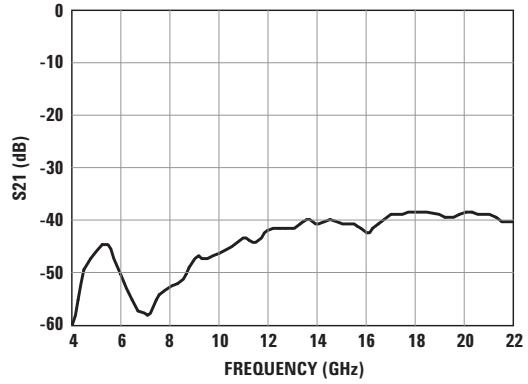

Figure 2. Isolation.

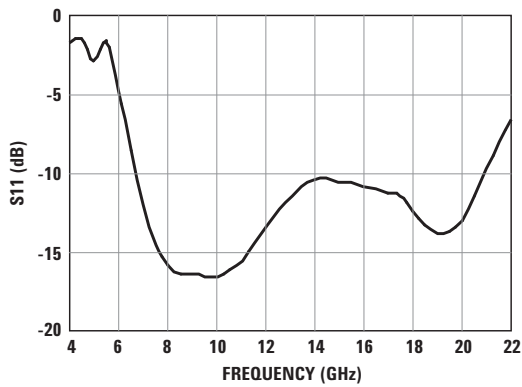

Figure 3. Input return loss.

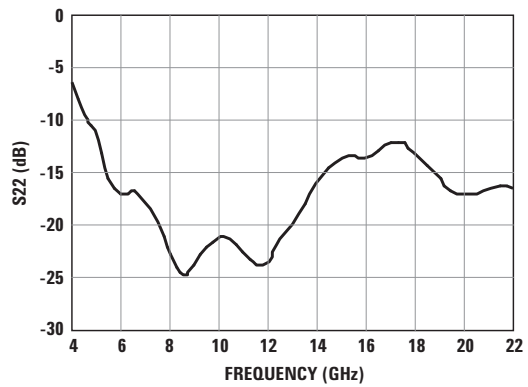

Figure 4. Output return loss.

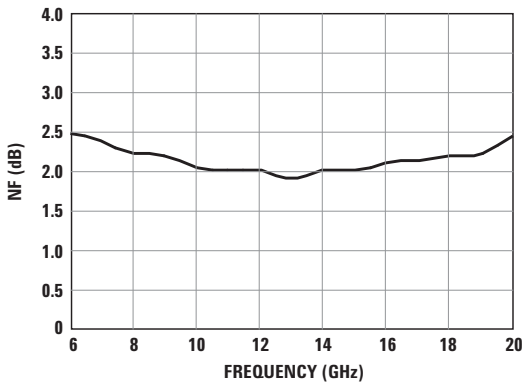

Figure 5. Noise figure.

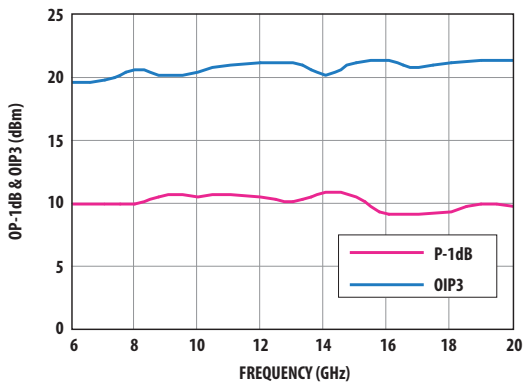

Figure 6. Typical power, OP-1dB and OIP3.

## Over Temperature Performance Plots

These measurements are in 50Ω test environment at  $T_A = 25^\circ\text{C}$ ,  $V_d = 3\text{V}$ ,  $I_d = 55\text{ mA}$ . Aspects of the amplifier performance may be improved over a narrower bandwidth by application of additional conjugate, linearity or low noise ( $\Gamma_{opt}$ ) matching.

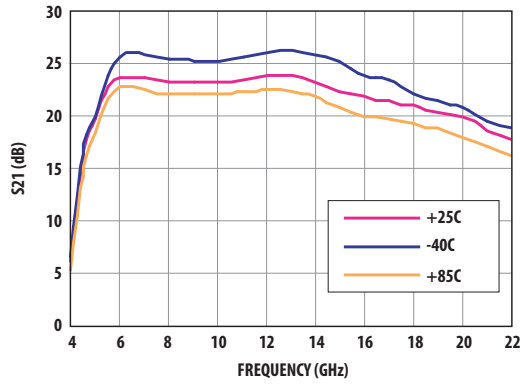

Figure 7. Gain over temperature.

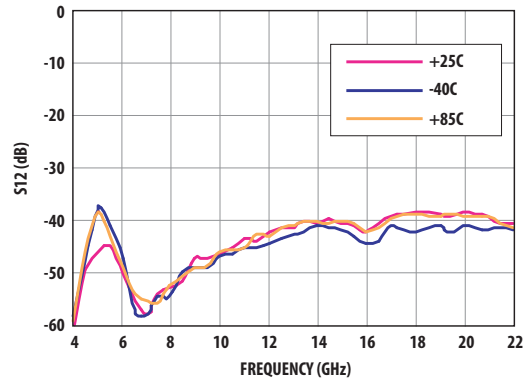

Figure 8. Isolation over temperature.

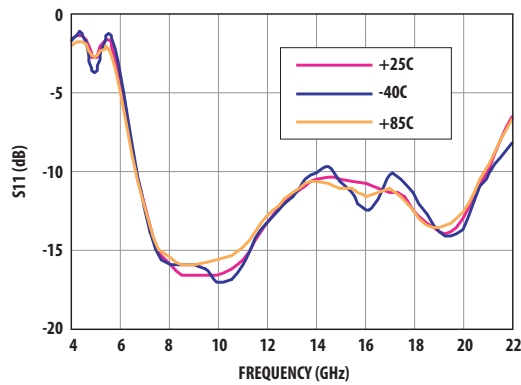

Figure 9. Input return loss over temperature.

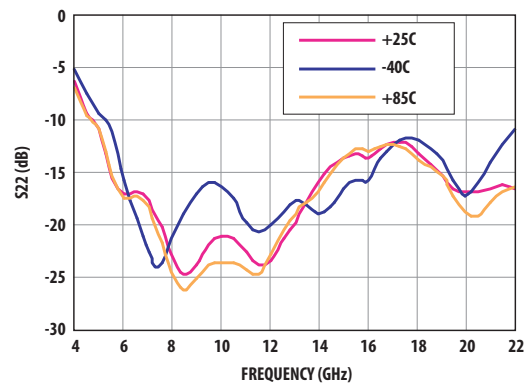

Figure 10. Output return loss over temperature.

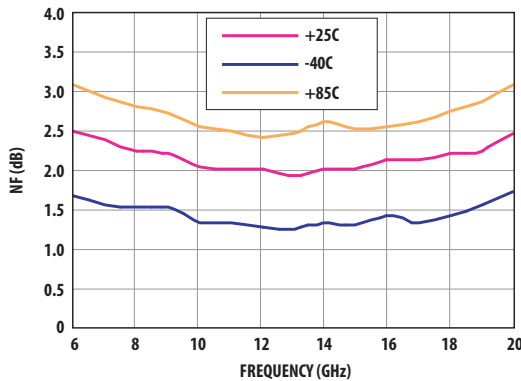

Figure 11. NF over temperature.

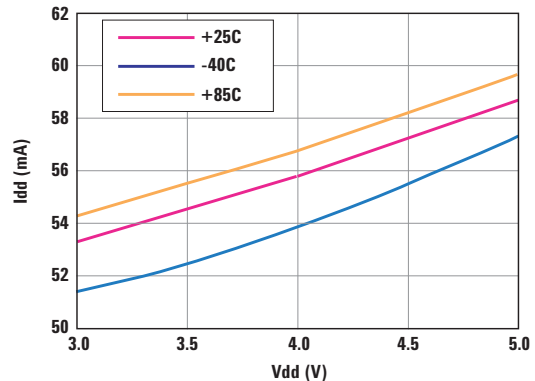

Figure 12. Bias current over temperature.

## Over Voltage plots

These measurements are in 50Ω test environment at  $T_A = 25^\circ\text{C}$ ,  $V_d = 3\text{V}$ ,  $I_d = 55\text{ mA}$ . Aspects of the amplifier performance may be improved over a narrower bandwidth by application of additional conjugate, linearity or low noise ( $\Gamma_{opt}$ ) matching.

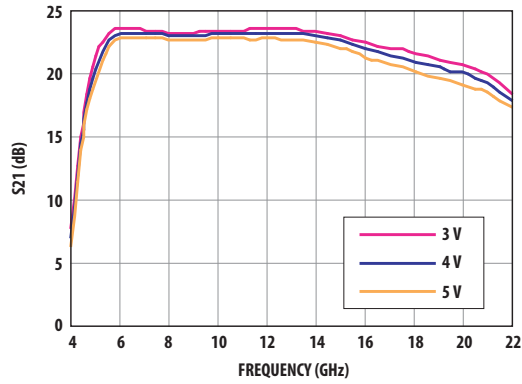

Figure 13. Gain over Vdd.

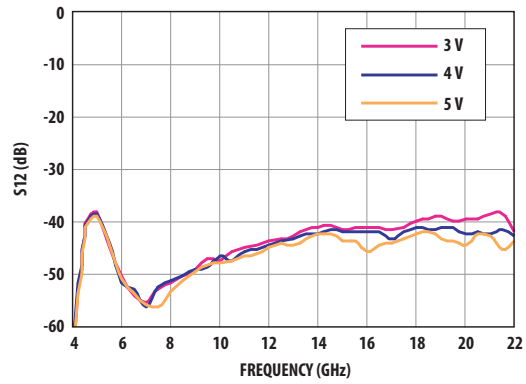

Figure 14. Isolation over Vdd.

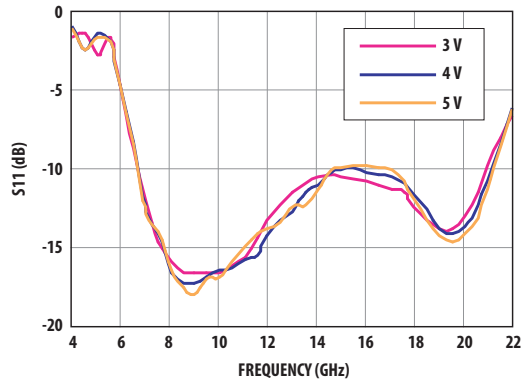

Figure 15. Input RL over Vdd.

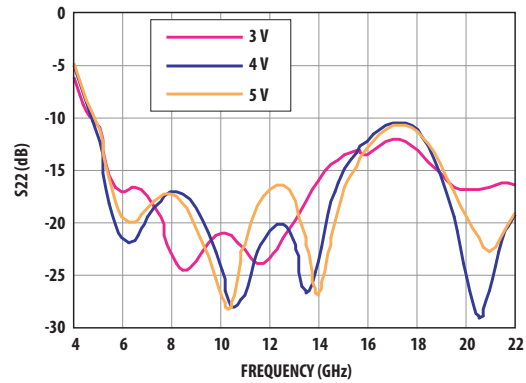

Figure 16. Output return loss over temperature.

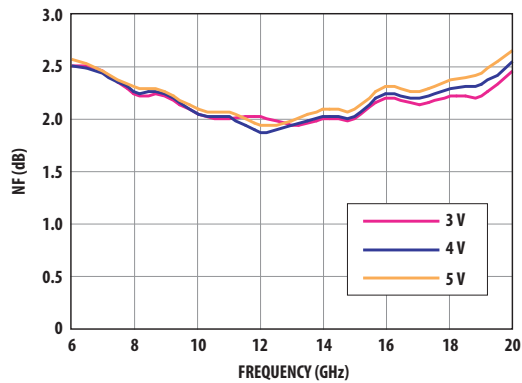

Figure 17. Noise figure over Vdd.

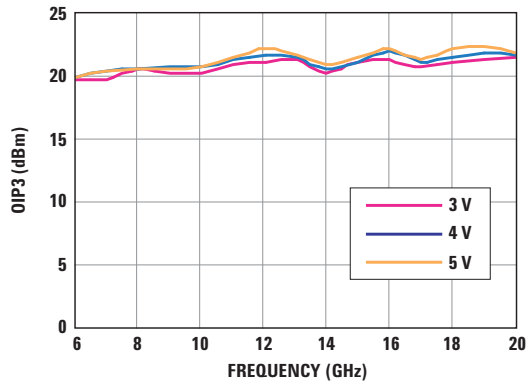

Figure 18. OIP3 over Vdd.

## Biasing and Operation

The AMMC-6220 is normally biased with a single positive drain supply connected to both  $V_D$  pin through bypass capacitors as shown in Figure 19. The recommended supply voltage is 3 V. It is important to have 0.1  $\mu\text{F}$  bypass capacitor, and the capacitor should be placed as close to the component as possible.

The AMMC-6220 does not require a negative gate voltage to bias any of the three stages. No ground wires are needed because all ground connections are made with plated through-holes to the backside of the package.

Refer the Absolute Maximum Ratings table for allowed DC and thermal conditions.

## Application Circuit

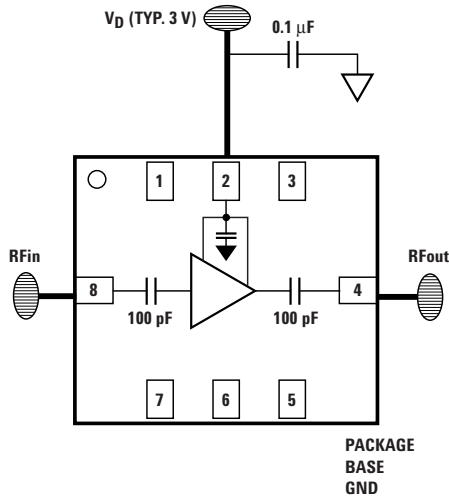

Figure 19. Typical application



Figure 21. Demonstration board (available upon request)

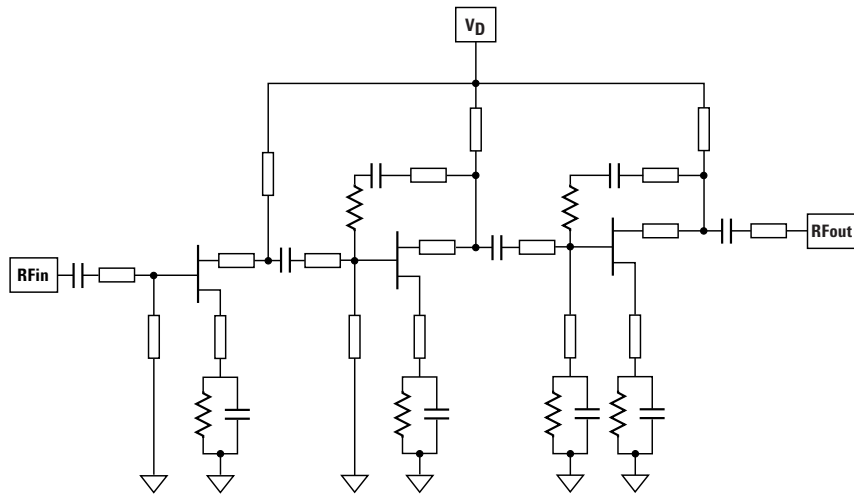

Figure 20. Simplified MMIC schematic

## Typical Scattering Parameters

Please refer to <<http://www.avagotech.com>> for typical scattering parameters data.

## Package Dimension, PCB Layout and Tape and Reel information

Please refer to Avago Technologies Application Note 5520, AMxP-xxxx production Assembly Process (Land Pattern A).

### AMMP-6220 Part Number Ordering Information

Part Number	Devices Per Container	Container
AMMP-6220-BLK	10	Antistatic bag
AMMP-6220-TR1	100	7" Reel
AMMP-6220-TR2	500	7" Reel



### Names and Contents of the Toxic and Hazardous Substances or Elements in the Products 产品中有毒有害物质或元素的名称及含量

Part Name 部件名称	Toxic and Hazardous Substances or Elements 有毒有害物质或元素					
	Lead (Pb) 铅 (Pb)	Mercury (Hg) 汞 (Hg)	Cadmium (Cd) 镉 (Cd)	Hexavalent (Cr(VI)) 六价 铬 (Cr(VI))	Polybrominated biphenyl (PBB) 多 溴联苯 (PBB)	Polybrominated diphenylether (PBDE) 多溴二苯醚 (PBDE)
100pF capacitor	x	o	o	o	o	o
<p>o: indicates that the content of the toxic and hazardous substance in all the homogeneous materials of the part is below the concentration limit requirement as described in SJ/T 11363-2006. x: indicates that the content of the toxic and hazardous substance in at least one homogeneous material of the part exceeds the concentration limit requirement as described in SJ/T 11363-2006. (The enterprise may further explain the technical reasons for the "x" indicated portion in the table in accordance with the actual situations.)</p> <p>o: 表示该有毒有害物质在该部件所有均质材料中的含量均在 SJ/T 11363-2006 标准规定的限量要求以下。 x: 表示该有毒有害物质至少在该部件的某一均质材料中的含量超出 SJ/T 11363-2006 标准规定的限量要求。 (企业可在此处, 根据实际情况对上表中打"x"的技术原因进行进一步说明。)</p>						

Note: EU RoHS compliant under exemption clause of "lead in electronic ceramic parts (e.g. piezoelectronic devices)"

For product information and a complete list of distributors, please go to our website: [www.avagotech.com](http://www.avagotech.com)

Avago, Avago Technologies, and the A logo are trademarks of Avago Technologies in the United States and other countries.  
Data subject to change. Copyright © 2005-2011 Avago Technologies. All rights reserved. Obsoletes 5989-4517EN  
AV02-0515EN - May 27, 2011



## Looking for pricing, stock, or lifecycle information?

Click below to explore more details on WIN SOURCE:

 [View AMMP-6220-TR2 on WIN SOURCE](#)

 [Broadcom Limited](#) Information

## Optimize Your Supply Chain with WIN SOURCE Solutions

-  Global Sourcing Solution
-  Obsolete Management
-  Cost Control Management
-  Shortage Management
-  Alternative Solution
-  Excess Inventory Management