

DATA SHEET

SURFACE MOUNT MULTILAYER CERAMIC CAPACITORS

Automotive grade

NP0/X7R/X7S

6.3 V TO 2000 V

0.2 pF to 680nF

RoHS compliant & Halogen Free



SCOPE

This specification describes Automotive grade chip capacitors with lead-free terminations and used for automotive equipments.

APPLICATIONS

All general purpose applications under normal operation and usage conditions for automotive equipments.

FEATURES

- AEC-Q200 qualified
- MSL class: MSL I
- AC series soldering is compliant with J-STD-020D
- High component and equipment reliability
- The capacitors are 100% performed by automatic optical inspection prior to taping.

ORDERING INFORMATION - GLOBAL PART NUMBER

All part numbers are identified by the series, size, tolerance, TC material, packing style, voltage, process code, termination and capacitance value.

GLOBAL PART NUMBER

AC XXXX X X XXX X **B** X XXX
 (1) (2) (3) (4) (5) (6) (7)

(1) SIZE – INCH BASED (METRIC)

0201 (0603) / 0402 (1005) / 0603 (1608) / 0805 (2012) / 1206 (3216) / 1210 (3225) / 1812 (4532) / 2220 (5750)

(2) TOLERANCE

NPO(< 10 pF)	NPO(≥ 10 pF)	X7R/X7S
B = ±0.1 pF	F = ±1%	J = ±5%
C = ±0.25 pF	G = ±2%	K = ±10%
D = ±0.5 pF	J = ±5%	M = ±20%

Note: Capacitance tolerance ±5% doesn't available for full X7R range, please contact local sale before order.

(3) PACKING STYLE (SEE TABLE. 12 FOR DETAIL)

- R = Paper/PE taping reel; Reel 7 inch
- K = Blister taping reel; Reel 7 inch
- P = Paper/PE taping reel; Reel 13 inch
- F = Blister taping reel; Reel 13 inch

(4) TC MATERIAL

- NPO
- X7R
- X7S

(5) RATED VOLTAGE

- | | |
|-----------|------------|
| 5 = 6.3 V | B = 500 V |
| 6 = 10 V | Z = 630 V |
| 7 = 16 V | C = 1000 V |
| 8 = 25 V | D = 2000 V |
| 9 = 50 V | |
| 0 = 100 V | |
| A = 200 V | |
| Y = 250 V | |

6) PROCESS

- N = NPO
- B = X7R/X7S

(7) CAPACITANCE VALUE

2 significant digits+number of zeros
 The 3rd digit signifies the multiplying factor, and letter R is decimal point
 Example: 121 = 12 × 10¹ = 120 pF

CONSTRUCTION

The capacitor consists of a rectangular block of ceramic dielectric in which a number of interleaved metal electrodes are contained. This structure gives rise to a high capacitance per unit volume.

The inner electrodes are connected to the two end terminations and finally covered with a layer of plated tin (Matte Sn). The terminations are lead-free. A cross section of the structure is shown in Fig.1.

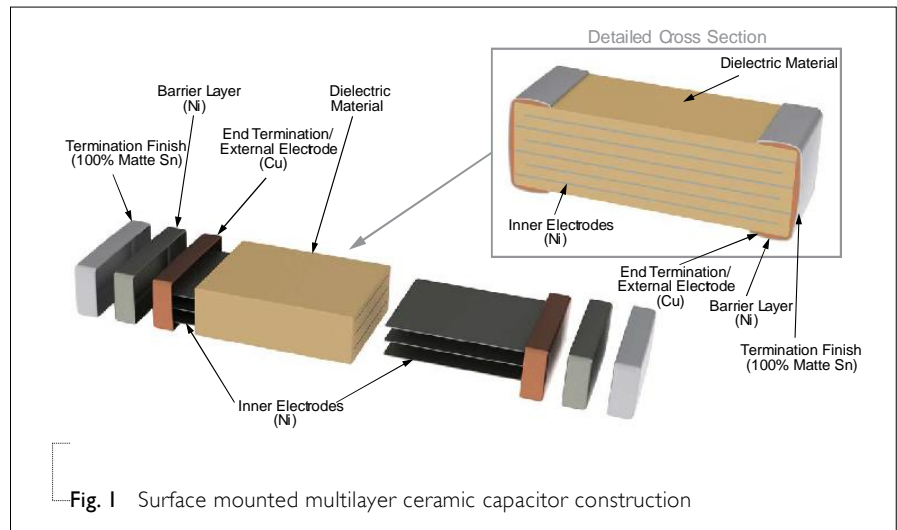

DIMENSION

Table I For outlines see fig. 2

TYPE	L ₁ (mm)	W (mm)	T (MM)	L ₂ / L ₃ (mm)		L ₄ (mm)
				min.	max.	min.
0201	0.6±0.03	0.3±0.03	0.3±0.03	0.10	0.20	0.20
0402	1.0±0.05	0.5 ±0.05	0.5±0.05	0.15	0.35	0.30
0603	1.6±0.10	0.8±0.10	0.8±0.10	0.20	0.50	0.60
0805	2.0±0.10	1.25±0.10	0.6±0.10	0.25	0.75	0.70
	2.0±0.20	1.25±0.20	0.85±0.10			
1206	3.2±0.30	1.6±0.20	0.6±0.10	0.25	0.75	1.50
			0.85±0.10			
			1.00±0.10			
			1.25±0.20			
1210	3.2±0.30	2.5±0.20	1.6±0.20	0.25	0.75	1.50
			2.0±0.20			
			2.5±0.20			
1808	4.5±0.40	2.0±0.30	1.25±0.20	0.25	0.75	2.20
			0.85±0.10			
1812	4.5±0.40	3.2±0.30	1.25±0.20	0.25	0.75	2.20
			1.60±0.20			
2220	5.7±0.40	5.0±0.30	2.0±0.20	0.25	0.75	3.40

OUTLINES

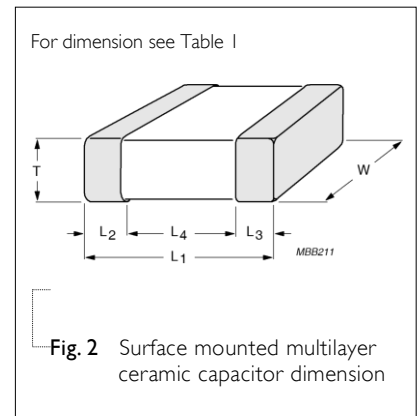

CAPACITANCE RANGE & THICKNESS FOR NPO

Table 2 Sizes from 0201 to 0805

CAP.	0201		0402		0603		0805			
	25 V / 50 V	25 V / 50 V	25 V / 50 V	100 V	200 V / 250 V	50 V	100 V	200 V / 250 V	500 V	630 V
0.2 pF	0.3±0.03									
0.47 pF	0.3±0.03	0.5±0.05	0.8±0.1	0.8±0.1	0.8±0.1	0.6±0.1	0.6±0.1	0.6±0.1		
0.56 pF	0.3±0.03	0.5±0.05	0.8±0.1	0.8±0.1	0.8±0.1	0.6±0.1	0.6±0.1	0.6±0.1		
0.68 pF	0.3±0.03	0.5±0.05	0.8±0.1	0.8±0.1	0.8±0.1	0.6±0.1	0.6±0.1	0.6±0.1		
0.82 pF	0.3±0.03	0.5±0.05	0.8±0.1	0.8±0.1	0.8±0.1	0.6±0.1	0.6±0.1	0.6±0.1		
1.0 pF	0.3±0.03	0.5±0.05	0.8±0.1	0.8±0.1	0.8±0.1	0.6±0.1	0.6±0.1	0.6±0.1		
1.2 pF	0.3±0.03	0.5±0.05	0.8±0.1	0.8±0.1	0.8±0.1	0.6±0.1	0.6±0.1	0.6±0.1		
1.5 pF	0.3±0.03	0.5±0.05	0.8±0.1	0.8±0.1	0.8±0.1	0.6±0.1	0.6±0.1	0.6±0.1		
1.8 pF	0.3±0.03	0.5±0.05	0.8±0.1	0.8±0.1	0.8±0.1	0.6±0.1	0.6±0.1	0.6±0.1		
2.2 pF	0.3±0.03	0.5±0.05	0.8±0.1	0.8±0.1	0.8±0.1	0.6±0.1	0.6±0.1	0.6±0.1		
2.7 pF	0.3±0.03	0.5±0.05	0.8±0.1	0.8±0.1	0.8±0.1	0.6±0.1	0.6±0.1	0.6±0.1		
3.3 pF	0.3±0.03	0.5±0.05	0.8±0.1	0.8±0.1	0.8±0.1	0.6±0.1	0.6±0.1	0.6±0.1		
3.9 pF	0.3±0.03	0.5±0.05	0.8±0.1	0.8±0.1	0.8±0.1	0.6±0.1	0.6±0.1	0.6±0.1		
4.7 pF	0.3±0.03	0.5±0.05	0.8±0.1	0.8±0.1	0.8±0.1	0.6±0.1	0.6±0.1	0.6±0.1		
5.6 pF	0.3±0.03	0.5±0.05	0.8±0.1	0.8±0.1	0.8±0.1	0.6±0.1	0.6±0.1	0.6±0.1		
6.8 pF	0.3±0.03	0.5±0.05	0.8±0.1	0.8±0.1	0.8±0.1	0.6±0.1	0.6±0.1	0.6±0.1		
8.2 pF	0.3±0.03	0.5±0.05	0.8±0.1	0.8±0.1	0.8±0.1	0.6±0.1	0.6±0.1	0.6±0.1		
10 pF	0.3±0.03	0.5±0.05	0.8±0.1	0.8±0.1	0.8±0.1	0.6±0.1	0.6±0.1	0.6±0.1	0.6±0.1	0.6±0.1
12 pF	0.3±0.03	0.5±0.05	0.8±0.1	0.8±0.1	0.8±0.1	0.6±0.1	0.6±0.1	0.6±0.1	0.6±0.1	0.6±0.1
15 pF	0.3±0.03	0.5±0.05	0.8±0.1	0.8±0.1	0.8±0.1	0.6±0.1	0.6±0.1	0.6±0.1	0.6±0.1	0.6±0.1
18 pF	0.3±0.03	0.5±0.05	0.8±0.1	0.8±0.1	0.8±0.1	0.6±0.1	0.6±0.1	0.6±0.1	0.6±0.1	0.6±0.1
22 pF	0.3±0.03	0.5±0.05	0.8±0.1	0.8±0.1	0.8±0.1	0.6±0.1	0.6±0.1	0.6±0.1	0.6±0.1	0.6±0.1
27 pF	0.3±0.03	0.5±0.05	0.8±0.1	0.8±0.1	0.8±0.1	0.6±0.1	0.6±0.1	0.6±0.1	0.6±0.1	0.6±0.1
33 pF	0.3±0.03	0.5±0.05	0.8±0.1	0.8±0.1	0.8±0.1	0.6±0.1	0.6±0.1	0.6±0.1	0.6±0.1	0.6±0.1
39 pF		0.5±0.05	0.8±0.1	0.8±0.1	0.8±0.1	0.6±0.1	0.6±0.1	0.6±0.1	0.6±0.1	0.6±0.1
47 pF		0.5±0.05	0.8±0.1	0.8±0.1	0.8±0.1	0.6±0.1	0.6±0.1	0.6±0.1	0.6±0.1	0.6±0.1
56 pF		0.5±0.05	0.8±0.1	0.8±0.1	0.8±0.1	0.6±0.1	0.6±0.1	0.6±0.1	0.6±0.1	0.6±0.1
68 pF		0.5±0.05	0.8±0.1	0.8±0.1	0.8±0.1	0.6±0.1	0.6±0.1	0.6±0.1	0.6±0.1	0.6±0.1
82 pF		0.5±0.05	0.8±0.1	0.8±0.1	0.8±0.1	0.6±0.1	0.6±0.1	0.6±0.1	0.6±0.1	0.6±0.1
100 pF		0.5±0.05	0.8±0.1	0.8±0.1	0.8±0.1	0.6±0.1	0.6±0.1	0.6±0.1	0.6±0.1	0.6±0.1

NOTE

1. Values in shaded cells indicate thickness class in mm
2. Capacitance value of non E-12 series is on request

CAPACITANCE RANGE & THICKNESS FOR NPO

Table 3 Sizes from 0402 to 0805 (continued)

CAP.	0402		0603		0805				
	25 V / 50 V	25 V / 50 V	100 V	200 V / 250 V	50 V	100 V	200 V / 250 V	500 V	630 V
120 pF	0.5±0.05	0.8±0.1	0.8±0.1	0.8±0.1	0.6±0.1	0.6±0.1	0.6±0.1	0.6±0.1	0.6±0.1
150 pF	0.5±0.05	0.8±0.1	0.8±0.1	0.8±0.1	0.6±0.1	0.6±0.1	0.6±0.1	0.6±0.1	0.6±0.1
180 pF	0.5±0.05	0.8±0.1	0.8±0.1	0.8±0.1	0.6±0.1	0.6±0.1	0.6±0.1	0.6±0.1	0.6±0.1
220 pF	0.5±0.05	0.8±0.1	0.8±0.1	0.8±0.1	0.6±0.1	0.6±0.1	0.85±0.1	0.85±0.1	
270 pF	0.5±0.05	0.8±0.1	0.8±0.1	0.8±0.1	0.6±0.1	0.6±0.1	0.85±0.1	0.85±0.1	
330 pF	0.5±0.05	0.8±0.1	0.8±0.1	0.8±0.1	0.6±0.1	0.6±0.1	0.85±0.1	0.85±0.1	
390 pF	0.5±0.05	0.8±0.1	0.8±0.1	0.8±0.1	0.6±0.1	0.6±0.1	0.85±0.1	0.85±0.1	
470 pF	0.5±0.05	0.8±0.1	0.8±0.1	0.8±0.1	0.6±0.1	0.6±0.1	0.85±0.1	0.85±0.1	
560 pF	0.5±0.05	0.8±0.1	0.8±0.1	0.8±0.1	0.6±0.1	0.85±0.1	0.85±0.1		
680 pF	0.5±0.05	0.8±0.1	0.8±0.1	0.8±0.1	0.6±0.1	0.85±0.1	0.85±0.1		
820 pF	0.5±0.05	0.8±0.1	0.8±0.1		0.6±0.1	0.85±0.1	0.85±0.1		
1.0 nF	0.5±0.05	0.8±0.1	0.8±0.1		0.6±0.1	0.85±0.1	0.85±0.1		
1.2 nF		0.8±0.1	0.8±0.1		0.85±0.1	0.85±0.1			
1.5 nF		0.8±0.1	0.8±0.1		0.85±0.1	0.85±0.1			
1.8 nF		0.8±0.1	0.8±0.1		0.85±0.1	0.85±0.1			
2.2 nF		0.8±0.1	0.8±0.1		1.25±0.2	1.25±0.2			
2.7 nF		0.8±0.1			1.25±0.2	1.25±0.2			
3.3 nF		0.8±0.1			1.25±0.2	1.25±0.2			
3.9 nF		0.8±0.1			1.25±0.2	1.25±0.2			
4.7 nF		0.8±0.1			1.25±0.2	1.25±0.2			
5.6 nF		0.8±0.1			1.25±0.2	1.25±0.2			
6.8 nF		0.8±0.1			1.25±0.2	1.25±0.2			
8.2 nF		0.8±0.1			1.25±0.2	1.25±0.2			
10 nF		0.8±0.1			1.25±0.2	1.25±0.2			

NOTE

1. Values in shaded cells indicate thickness class in mm
2. Capacitance value of non E-12 series is on request

CAPACITANCE RANGE & THICKNESS FOR NPO

Table 4 Sizes from 1206 to 1210

CAP.	1206							1210					
	50 V	100 V	200 V / 250 V	500 V	630 V	1000 V	2000 V	50 V	100 V	200 V / 250 V	500 V	630 V	1000 V
10 pF	0.6±0.1	0.6±0.1	0.6±0.1	0.6±0.1	1.25±0.2	1.25±0.2	1.25±0.2						
12 pF	0.6±0.1	0.6±0.1	0.6±0.1	0.6±0.1	1.25±0.2	1.25±0.2	1.25±0.2						
15 pF	0.6±0.1	0.6±0.1	0.6±0.1	0.6±0.1	1.25±0.2	1.25±0.2	1.25±0.2						
18 pF	0.6±0.1	0.6±0.1	0.6±0.1	0.6±0.1	1.25±0.2	1.25±0.2	1.25±0.2						
22 pF	0.6±0.1	0.6±0.1	0.6±0.1	0.6±0.1	1.25±0.2	1.25±0.2	1.25±0.2						
27 pF	0.6±0.1	0.6±0.1	0.6±0.1	0.6±0.1	1.25±0.2	1.25±0.2	1.25±0.2						
33 pF	0.6±0.1	0.6±0.1	0.6±0.1	0.6±0.1	1.25±0.2	1.25±0.2	1.25±0.2						
39 pF	0.6±0.1	0.6±0.1	0.6±0.1	0.6±0.1	1.25±0.2	1.25±0.2	1.25±0.2						
47 pF	0.6±0.1	0.6±0.1	0.6±0.1	0.6±0.1	1.25±0.2	1.25±0.2	1.25±0.2	1.25±0.2	1.25±0.2	1.25±0.2	1.25±0.2		
56 pF	0.6±0.1	0.6±0.1	0.6±0.1	0.6±0.1	1.25±0.2	1.25±0.2		1.25±0.2	1.25±0.2	1.25±0.2	1.25±0.2		
68 pF	0.6±0.1	0.6±0.1	0.6±0.1	0.6±0.1	1.25±0.2	1.25±0.2		1.25±0.2	1.25±0.2	1.25±0.2	1.25±0.2		
82 pF	0.6±0.1	0.6±0.1	0.6±0.1	0.6±0.1	1.25±0.2	1.25±0.2		1.25±0.2	1.25±0.2	1.25±0.2	1.25±0.2		
100 pF	0.6±0.1	0.6±0.1	0.6±0.1	0.6±0.1	1.25±0.2	1.25±0.2		1.25±0.2	1.25±0.2	1.25±0.2	1.25±0.2		
120 pF	0.6±0.1	0.6±0.1	0.6±0.1	0.6±0.1	1.25±0.2	1.25±0.2		1.25±0.2	1.25±0.2	1.25±0.2	1.25±0.2		
150 pF	0.6±0.1	0.6±0.1	0.6±0.1	0.6±0.1	1.25±0.2	1.25±0.2		1.25±0.2	1.25±0.2	1.25±0.2	1.25±0.2		
180 pF	0.6±0.1	0.6±0.1	0.6±0.1	0.6±0.1	1.25±0.2	1.25±0.2		1.25±0.2	1.25±0.2	1.25±0.2	1.25±0.2		
220 pF	0.6±0.1	0.6±0.1	0.6±0.1	0.6±0.1	1.25±0.2	1.25±0.2		1.25±0.2	1.25±0.2	1.25±0.2	1.25±0.2		
270 pF	0.6±0.1	0.6±0.1	0.6±0.1	0.6±0.1	1.25±0.2			1.25±0.2	1.25±0.2	1.25±0.2	1.25±0.2		
330 pF	0.6±0.1	0.6±0.1	0.6±0.1	0.6±0.1	1.25±0.2			1.25±0.2	1.25±0.2	1.25±0.2	1.25±0.2		
390 pF	0.6±0.1	0.6±0.1	0.6±0.1	0.6±0.1	1.25±0.2			1.25±0.2	1.25±0.2	1.25±0.2	1.25±0.2		
470 pF	0.6±0.1	0.6±0.1	0.6±0.1	0.6±0.1	1.25±0.2			1.25±0.2	1.25±0.2	1.25±0.2	1.25±0.2		
560 pF	0.6±0.1	0.6±0.1	0.6±0.1	0.6±0.1	1.25±0.2			1.25±0.2	1.25±0.2	1.25±0.2	1.25±0.2		
680 pF	0.6±0.1	0.6±0.1	0.6±0.1	0.6±0.1	1.25±0.2			1.25±0.2	1.25±0.2	1.25±0.2	1.25±0.2		
820 pF	0.6±0.1	0.6±0.1	0.85±0.1	0.85±0.1	1.25±0.2			1.25±0.2	1.25±0.2	1.25±0.2	1.25±0.2		
1.0 nF	0.6±0.1	0.6±0.1	0.85±0.1	0.85±0.1	1.25±0.2			1.25±0.2	1.25±0.2	1.25±0.2	1.25±0.2		
1.2 nF	0.6±0.1	0.6±0.1	0.85±0.1		1.25±0.2			1.25±0.2	1.25±0.2	1.25±0.2	1.25±0.2		
1.5 nF	0.6±0.1	0.6±0.1	0.85±0.1		1.25±0.2			1.25±0.2	1.25±0.2	1.25±0.2	1.25±0.2		
1.8 nF	0.6±0.1	0.6±0.1			1.25±0.2			1.25±0.2	1.25±0.2	1.25±0.2	1.25±0.2		
2.2 nF	0.6±0.1	0.6±0.1			1.25±0.2			1.25±0.2	1.25±0.2	1.25±0.2			
2.7 nF	0.6±0.1	0.6±0.1			1.25±0.2			1.25±0.2	1.25±0.2	1.25±0.2			
3.3 nF					1.25±0.2								
3.9 nF					1.25±0.2								
4.7 nF					1.25±0.2							1.60±0.2	2.0±0.2
5.6 nF					1.60±0.2							1.60±0.2	2.0±0.2
6.8 nF					1.60±0.2							1.60±0.2	2.0±0.2
8.2 nF					1.60±0.2							1.60±0.2	2.0±0.2
10 nF					1.60±0.2							1.60±0.2	2.5±0.3
22 nF												2.0±0.2	2.5±0.3
33 nF												2.5±0.3	
47 nF													

NOTE

1. Values in shaded cells indicate thickness class in mm
2. Capacitance value of non E-12 series is on request



CAPACITANCE RANGE & THICKNESS FOR X7R/X7S

Table 5 Sizes from 0201 to 0603

CAP.	0201		0402				0603					
	25V	50 V	10V	16 V	25 V	50 V	100 V	10V	16 V	25 V	50 V	100 V
100 pF	0.3±0.03	0.3±0.03	0.5±0.05	0.5±0.05	0.5±0.05	0.5±0.05		0.8±0.1	0.8±0.1	0.8±0.1	0.8±0.1	0.8±0.1
150 pF	0.3±0.03	0.3±0.03	0.5±0.05	0.5±0.05	0.5±0.05	0.5±0.05		0.8±0.1	0.8±0.1	0.8±0.1	0.8±0.1	0.8±0.1
220 pF	0.3±0.03	0.3±0.03	0.5±0.05	0.5±0.05	0.5±0.05	0.5±0.05	0.5±0.05	0.8±0.1	0.8±0.1	0.8±0.1	0.8±0.1	0.8±0.1
330 pF	0.3±0.03	0.3±0.03	0.5±0.05	0.5±0.05	0.5±0.05	0.5±0.05	0.5±0.05	0.8±0.1	0.8±0.1	0.8±0.1	0.8±0.1	0.8±0.1
470 pF	0.3±0.03	0.3±0.03	0.5±0.05	0.5±0.05	0.5±0.05	0.5±0.05	0.5±0.05	0.8±0.1	0.8±0.1	0.8±0.1	0.8±0.1	0.8±0.1
680 pF	0.3±0.03	0.3±0.03	0.5±0.05	0.5±0.05	0.5±0.05	0.5±0.05	0.5±0.05	0.8±0.1	0.8±0.1	0.8±0.1	0.8±0.1	0.8±0.1
1.0 nF	0.3±0.03	0.3±0.03	0.5±0.05	0.5±0.05	0.5±0.05	0.5±0.05	0.5±0.05	0.8±0.1	0.8±0.1	0.8±0.1	0.8±0.1	0.8±0.1
1.5 nF	0.3±0.03		0.5±0.05	0.5±0.05	0.5±0.05	0.5±0.05	0.5±0.05	0.8±0.1	0.8±0.1	0.8±0.1	0.8±0.1	0.8±0.1
2.2 nF	0.3±0.03		0.5±0.05	0.5±0.05	0.5±0.05	0.5±0.05		0.8±0.1	0.8±0.1	0.8±0.1	0.8±0.1	0.8±0.1
3.3 nF	0.3±0.03		0.5±0.05	0.5±0.05	0.5±0.05	0.5±0.05		0.8±0.1	0.8±0.1	0.8±0.1	0.8±0.1	0.8±0.1
4.7 nF	0.3±0.03		0.5±0.05	0.5±0.05	0.5±0.05	0.5±0.05		0.8±0.1	0.8±0.1	0.8±0.1	0.8±0.1	0.8±0.1
6.8 nF	0.3±0.03		0.5±0.05	0.5±0.05	0.5±0.05	0.5±0.05		0.8±0.1	0.8±0.1	0.8±0.1	0.8±0.1	0.8±0.1
10 nF	0.3±0.03		0.5±0.05	0.5±0.05	0.5±0.05	0.5±0.05		0.8±0.1	0.8±0.1	0.8±0.1	0.8±0.1	0.8±0.1
15 nF			0.5±0.05	0.5±0.05	0.5±0.05	0.5±0.05		0.8±0.1	0.8±0.1	0.8±0.1	0.8±0.1	0.8±0.1
22 nF			0.5±0.05	0.5±0.05	0.5±0.05	0.5±0.05		0.8±0.1	0.8±0.1	0.8±0.1	0.8±0.1	0.8±0.1
33 nF			0.5±0.05	0.5±0.05	0.5±0.05	0.5±0.05		0.8±0.1	0.8±0.1	0.8±0.1	0.8±0.1	0.8±0.1
47 nF			0.5±0.05	0.5±0.05	0.5±0.05	0.5±0.05		0.8±0.1	0.8±0.1	0.8±0.1	0.8±0.1	0.8±0.1
68 nF			0.5±0.05	0.5±0.05	0.5±0.05	0.5±0.05		0.8±0.1	0.8±0.1	0.8±0.1	0.8±0.1	0.8±0.1
100 nF			0.5±0.05	0.5±0.05	0.5±0.05	0.5±0.05		0.8±0.1	0.8±0.1	0.8±0.1	0.8±0.1	0.8±0.1
150 nF			0.5±0.05 (X7S)	0.5±0.05 (X7S)				0.8±0.1	0.8±0.1	0.8±0.1	0.8±0.1	
220 nF			0.5±0.05 (X7S)	0.5±0.05 (X7S)				0.8±0.1	0.8±0.1	0.8±0.1	0.8±0.1	
330 nF								0.8±0.1	0.8±0.1	0.8±0.1		
470 nF								0.8±0.1	0.8±0.1	0.8±0.1		
680 nF								0.8±0.1	0.8±0.1	0.8±0.1		

NOTE

1. Values in shaded cells indicate thickness class in mm
2. Capacitance value of non E-6 series is on request

CAPACITANCE RANGE & THICKNESS FOR X7R

Table 6 Size 0805

CAP.	0805						
	10 V	16 V	25 V	50 V	100 V	200 V / 250 V	500 V
1.0 nF	0.85±0.1	0.85±0.1	0.85±0.1	0.85±0.1	0.85±0.1	0.85±0.1	0.85±0.1
1.5 nF	0.85±0.1	0.85±0.1	0.85±0.1	0.85±0.1	0.85±0.1	0.85±0.1	0.85±0.1
2.2 nF	0.85±0.1	0.85±0.1	0.85±0.1	0.85±0.1	0.85±0.1	0.85±0.1	0.85±0.1
3.3 nF	0.85±0.1	0.85±0.1	0.85±0.1	0.85±0.1	0.85±0.1	0.85±0.1	0.85±0.1
4.7 nF	0.85±0.1	0.85±0.1	0.85±0.1	0.85±0.1	0.85±0.1	0.85±0.1	0.85±0.1
6.8 nF	0.85±0.1	0.85±0.1	0.85±0.1	0.85±0.1	0.85±0.1	1.25±0.2	
10 nF	0.85±0.1	0.85±0.1	0.85±0.1	0.85±0.1	0.85±0.1	1.25±0.2	
15 nF	0.85±0.1	0.85±0.1	0.85±0.1	0.85±0.1	0.85±0.1	1.25±0.2	
22 nF	0.85±0.1	0.85±0.1	0.85±0.1	0.85±0.1	0.85±0.1	1.25±0.2	
33 nF	0.85±0.1	0.85±0.1	0.85±0.1	0.85±0.1	1.25±0.2		
47 nF	0.85±0.1	0.85±0.1	0.85±0.1	0.85±0.1	1.25±0.2		
68 nF	0.85±0.1	0.85±0.1	0.85±0.1	0.85±0.1 1.25±0.2	1.25±0.2		
100 nF	0.85±0.1	0.85±0.1	0.85±0.1	0.85±0.1 1.25±0.2	1.25±0.2		
150 nF	0.85±0.1	0.85±0.1	0.85±0.1	1.25±0.2			
220 nF	0.85±0.1	0.85±0.1	0.85±0.1	1.25±0.2			
330 nF	1.25±0.2	1.25±0.2	1.25±0.2	1.25±0.2			
470 nF	1.25±0.2	1.25±0.2	1.25±0.2	1.25±0.2			
680 nF	1.25±0.2	1.25±0.2	1.25±0.2	1.25±0.2			

NOTE

1. Values in shaded cells indicate thickness class in mm
2. Capacitance value of non E-6 series is on request

CAPACITANCE RANGE & THICKNESS FOR X7R

Table 7 Size 1206

CAP.	1206									
	6.3 V	10V	16V	25V	50 V	100 V	200 V / 250 V	500 V	630 V	1000 V
220 pF	1.25±0.2	1.25±0.2	1.25±0.2	1.25±0.2	1.25±0.2	1.25±0.2	1.25±0.2	1.25±0.2	1.25±0.2	1.25±0.2
330 pF	1.25±0.2	1.25±0.2	1.25±0.2	1.25±0.2	1.25±0.2	1.25±0.2	1.25±0.2	1.25±0.2	1.25±0.2	1.25±0.2
470 pF	1.25±0.2	1.25±0.2	1.25±0.2	1.25±0.2	1.25±0.2	1.25±0.2	1.25±0.2	1.25±0.2	1.25±0.2	1.25±0.2
680 pF	1.25±0.2	1.25±0.2	1.25±0.2	1.25±0.2	1.25±0.2	1.25±0.2	1.25±0.2	1.25±0.2	1.25±0.2	1.25±0.2
1 nF	1.25±0.2	1.25±0.2	1.25±0.2	1.25±0.2	1.25±0.2	1.25±0.2	1.25±0.2	1.25±0.2	1.25±0.2	1.25±0.2
2.2 nF	1.25±0.2	1.25±0.2	1.25±0.2	1.25±0.2	1.25±0.2	1.25±0.2	1.25±0.2	1.25±0.2	1.25±0.2	1.25±0.2
4.7 nF	1.25±0.2	1.25±0.2	1.25±0.2	1.25±0.2	1.25±0.2	1.25±0.2	1.25±0.2	1.25±0.2	1.25±0.2	1.25±0.2
10 nF	1.25±0.2	1.25±0.2	1.25±0.2	1.25±0.2	1.25±0.2	1.25±0.2	1.25±0.2	1.25±0.2	1.25±0.2	1.25±0.2
22 nF	0.85±0.1	0.85±0.1	0.85±0.1	0.85±0.1	0.85±0.1	0.85±0.1	1.25±0.2			
33 nF	0.85±0.1	0.85±0.1	0.85±0.1	0.85±0.1	0.85±0.1	0.85±0.1	1.60±0.2			
47 nF	0.85±0.1	0.85±0.1	0.85±0.1	0.85±0.1	0.85±0.1	0.85±0.1	1.60±0.2			
68 nF	0.85±0.1	0.85±0.1	0.85±0.1	0.85±0.1	0.85±0.1	1.25±0.2	1.60±0.2			
100 nF	0.85±0.1	0.85±0.1	0.85±0.1	0.85±0.1	0.85±0.1	1.25±0.2	1.60±0.2			
150 nF	0.85±0.1	0.85±0.1	0.85±0.1	0.85±0.1	1.25±0.2	1.25±0.2				
220 nF	0.85±0.1	0.85±0.1	0.85±0.1	0.85±0.1	1.25±0.2	1.25±0.2				
330 nF	0.85±0.1	0.85±0.1	0.85±0.1	0.85±0.1	1.60±0.2	1.60±0.2				
470 nF	1.00±0.1	1.00±0.1	1.00±0.1	1.00±0.1	1.60±0.2	1.60±0.2				
680 nF	1.15±0.1	1.15±0.1	1.15±0.1	1.60±0.2	1.60±0.2	1.60±0.2				

Table 8 Size 1210

CAP.	1210							1812	
	6.3V	10 V	16 V	25 V	50V	100 V	200 V / 250 V	50V	100V
100 nF	0.85±0.1	0.85±0.1	0.85±0.1	0.85±0.1	0.85±0.1	0.85±0.1	1.25±0.2		
150 nF	0.85±0.1	0.85±0.1	0.85±0.1	0.85±0.1	1.25±0.2	1.25±0.2			
220 nF	0.85±0.1	0.85±0.1	0.85±0.1	0.85±0.1	1.25±0.2	1.25±0.2			
330 nF	0.85±0.1	0.85±0.1	0.85±0.1	0.85±0.1	1.25±0.2	2.0±0.2			
470 nF	1.25±0.2	1.25±0.2	1.25±0.2	1.25±0.2	1.25±0.2	2.0±0.2		1.60±0.2	1.60±0.2
680 nF	1.25±0.2	1.25±0.2	1.25±0.2	1.25±0.2	1.25±0.2	2.0±0.2		1.60±0.2	1.60±0.2

NOTE

1. Values in shaded cells indicate thickness class in mm
2. Capacitance value of non E-6 series is on request

ELECTRICAL CHARACTERISTICS

NP0/X7R DIELECTRIC CAPACITORS; NI/SIN TERMINATIONS

Unless otherwise specified, all test and measurements shall be made under standard atmospheric conditions for testing as given in 5.3 of IEC 60068-1:

- Temperature: 15 ° C to 35 ° C
- Relative humidity: 25% to 75%
- Air pressure: 86 kPa to 106 kPa

Before the measurements are made, the capacitor shall be stored at the measuring temperature for a time sufficient to allow the entire capacitor to reach this temperature.

The period as prescribed for recovery at the end of a test is normally sufficient for this purpose.

Table 9

DESCRIPTION								VALUE
Capacitance range								0.2 pF to 680 nF
Dissipation factor (D.F.)								
NPO		C < 30 pF						≤ 1 / (400 + 20C)
		C ≥ 30 pF						≤ 0.1 %
X7R/X7S	0201	0402	0603	0805	1206	1210	1812	
≤10V	100pF to 220nF	100pF to 680nF	1nF to 680nF	220pF to 680nF	100nF to 680nF			≤ 5%
16V	100pF to 22nF	100pF to 220nF	1nF to 470nF	220pF to 680nF	100nF to 680nF			≤ 3.5%
	27nF to 220nF	330nF to 680nF	680nF					≤ 5%
25V	100pF to 470pF	100pF to 10nF	100pF to 39nF	1nF to 180nF	220pF to 680nF	100nF to 680nF		≤ 2.5%
		12nF to 27nF	47nF to 220nF	220nF				≤ 3.5%
	560pF to 10nF	33nF to 100nF	330nF to 680nF	330nF to 680nF				≤ 5%
50V	100pF to 470pF	100pF to 10nF	100pF to 39nF	1nF to 180nF	220pF to 470nF	100nF to 680nF	470nF to 680nF	≤ 2.5%
	560pF to 1nF		47nF to 220nF	220nF to 470nF				≤ 3.5%
		12nF to 100nF		560nF to 680nF	680nF			≤ 5%
100V	220pF to 1.5nF	100pF to 10nF	1nF to 100nF	220pF to 470nF	100nF to 270nF	470nF to 680nF		≤ 2.5%
		12nF to 100nF		560nF to 680nF	330nF to 680nF			≤ 5%
200V/250V			1nF to 22nF	220pF to 100nF	100nF			≤ 2.5%
500V			1nF to 4.7nF	220pF to 10nF				≤ 2.5%
630V				220pF to 10nF				≤ 2.5%
1KV				220pF to 1nF				≤ 2.5%

Insulation resistance after 1 minute at U_r (DC)

NPO (general)

I.R. ≥ 100 GΩ or I.R. × C ≥ 1000 Ω.F. whichever is less
 1206/630V > 1nF, 1210/630V & 1KV > 1nF
 I.R. ≥ 10 GΩ or I.R. × C ≥ 500 Ω.F. whichever is less

X7R (general)

0603/25V/330nF to 470nF
 0603/10V to 25V/560nF to 680nF
 0402/10V/> 100nF
 0402/16V/> 100nF

I.R. ≥ 10 GΩ or I.R. × C ≥ 500 Ω.F. whichever is less
 I.R. × C ≥ 100 Ω.F.
 I.R. × C ≥ 100 Ω.F.
 I.R. × C ≥ 50 Ω.F.
 I.R. × C ≥ 50 Ω.F.

X7S (general)

0402/10V/> 100nF
 0402/16V/> 100nF

I.R. ≥ 1 GΩ or I.R. × C ≥ 100 Ω.F. whichever is less
 I.R. × C ≥ 50 Ω.F.
 I.R. × C ≥ 50 Ω.F.

Operating temperature range:

NP0/X7R/X7S

-55 °C to +125 °C

SOLDERING RECOMMENDATION

Table 10

SOLDERING METHOD	SIZE 0201	0402	0603	0805	1206	≥ 1210
Reflow	Reflow only	≥ 0.1 μF	≥ 1.0 μF	≥ 2.2 μF	≥ 4.7 μF	Reflow only
Reflow/Wave		< 0.1 μF	< 1.0 μF	< 2.2 μF	< 4.7 μF	---

SOLDERING CONDITIONS

The lead free MLCCs are able to stand the reflow soldering conditions as below:

- Temperature: above 220 °C
- Endurance: 95 to 120 seconds
- Cycles: 3 times

The test of "soldering heat resistance" is carried out in accordance with the schedule of "MIL-STD-202G-method 210F", "The robust construction of chip capacitors allows them to be completely immersed in a solder bath of 260 °C for 10 seconds". Therefore, it is possible to mount MLCCs on one side of a PCB and other discrete components on the reverse (mixed PCBs). Surface Mount Capacitors are tested for solderability at 245 °C during 2 seconds. The test condition for no leaching is 260°C for 30 seconds.

TESTS AND REQUIREMENTS

Table 11 Test procedures and requirements

NO	AEC-Q200 TEST	TEST METHOD	REQUIREMENTS
1	High Temperature Exposure	Unpowered ; 1000hours @ T=150 °C Measurement at 24±2 hours after test conclusion.	No visual damage
			ΔC/C NPO: Within ±2.5% or 0.25 pF, whichever is greater X7R/X7S: Within ±10%
			D.F.: within initial specified value
2	Temperature Cycling	Preconditioning: 150 +0/-10 °C for 1 hour, then keep for 24 ±1 hours at room temperature 1000 cycles with following detail: 30 minutes at lower category temperature 30 minutes at upper category temperature Recovery time 24 ±2 hours	No visual damage
			ΔC/C NPO: Within ±2.5% or 0.25 pF, whichever is greater X7R/X7S: ±10%
			D.F. meet initial specified value
			IR meet initial specified value
3	Destructive Physical Analysis	Electrical test not required.	
4	Moisture Resistance		No visual damage

NO	AEC-Q200 TEST	TEST METHOD	REQUIREMENTS
		<p>T=24 hrs/per cycle; 10 continuous cycles unpowered. Measurement at 24 ±2 hours after test condition.</p> 	<p>ΔC/C NPO: Within ±3% or 3 pF, whichever is greater X7R/X7S: ±15%</p> <p>D.F. Within initial specified value</p> <p>IR Meet initial specified value</p>
5	Biased Humidity	<ol style="list-style-type: none"> Preconditioning, class 2 only: 150 +0/-10 °C /1 hour, then keep for 24 ±1 hour at room temp Initial measure: Spec. refer to initial spec. C. D. I.R. Note: Series with 100 KΩ Test condition: 85 °C, 85% R.H. connected with 100 KΩ resistor, applied 1.5V/U_r (no more than 630V) for 1,000 hours. Recovery: NPO: 6 to 24 hours X7R/X7S: 24 ±2 hours Final measure: C. D. I.R. 	<p>No visual damage after recovery</p> <p>ΔC/C NPO: Within ±2% or 1 pF, whichever is greater X7R/X7S: ±15%</p> <p>D.F. NPO: ≤ 2 × specified value. X7R/X7S: (1) ≤ 16V: ≤ 7% or specified value whichever is greater (2) ≥ 25V: ≤ 5% or specified value whichever is greater</p> <p>I.R. The insulation resistance shall be greater than 10% of initial spec.</p>

Fig. 3 Moisture resistant

6	High Temperature Operational Life	<p>1. Preconditioning, class 2 only: 150 +0/-10 °C /1 hour, then keep for 24 ±1 hour at room temp</p> <p>2. Initial measure: Spec: refer to initial spec C, D, IR</p> <p>3. Endurance test: Temperature: 125 °C Specified stress voltage applied for 1,000 hours: Applied 2.0 × Ur for general products * High voltage series follows with below stress condition: Applied 1.5 × Ur for 200V, 250V series Applied 1.3 × Ur for 500V, 630V series Applied 1.2 × Ur for 1KV, 2KV, 3KV series</p> <p>Recovery time: 24 ±2 hours Final measure: C, D, IR</p> <p>Note: If the capacitance value is less than the minimum value permitted, then after the other measurements have been made the capacitor shall be preconditioned according to "IEC 60384 4.1" and then the requirement shall be met.</p> <p>* Applied 1.5 × Ur 0402/X7S/10V~16V/>100nF 0402/X7R/50V/>10nF 0603/X7R/25V/>220nF; 0603/X7R/50V/220nF 0603/X7R/100V/≥100nF 0805/X7R/100V/≥ 470nF</p>	No visual damage
			<p>ΔC/C NPO: Within ±2% or 1 pF, whichever is greater X7R/X7S: ±15%</p>
			<p>D.F. NPO: ≤ 2 × specified value. X7R/X7S: (1) ≤ 16V: ≤ 7% or specified value whichever is greater (2) ≥ 25V: ≤ 5% or specified value whichever is greater</p>
			<p>IR NPO: ≥ 4,000 MΩ or IR × Cr ≥ 40Ω.F. whichever is less X7R/X7S: ≥ 1,000 MΩ or IR × Cr ≥ 50Ω.F. whichever is less * * IR × Cr ≥ 5Ω.F. 0402/10V-16V/>100nF * IR × Cr ≥ 10Ω.F. 0603/25V/>220nF</p>
7	External Visual	Any applicable method using × 10 magnification	In accordance with specification
8	Physical Dimension	Verify physical dimensions to the applicable device specification.	In accordance with specification
9	Mechanical Shock	<p>Three shocks in each direction shall be applied along the three mutually perpendicular axes of the test specimen (18 shocks) Peak value: 1,500 g's Duration: 0.5 ms Velocity change: 15.4 ft/s Waveform: Half-sin</p>	<p>ΔC/C NPO: Within ±0.5% or 0.5 pF, whichever is greater X7R/X7S: ±10%</p>
			<p>D.F. Within initial specified value</p>
			<p>IR Within initial specified value</p>

10	Vibration	5 g's for 20 minutes, 12 cycles each of 3 orientations. Test from 10-2000 Hz.	$\Delta C/C$ NPO: Within $\pm 0.5\%$ or 0.5 pF, whichever is greater X7R/X7S: $\pm 10\%$
			D.F: meet initial specified value
			IR meet initial specified value
11	Resistance to Soldering Heat	Precondition: 150 ± 10 °C for 1 hour, then keep for 24 ± 1 hours at room temperature Preheating: for size ≤ 1206 : 120 °C to 150 °C for 1 minute Preheating: for size > 1206 : 100 °C to 120 °C for 1 minute and 170 °C to 200 °C for 1 minute Solder bath temperature: 260 ± 5 °C Dipping time: 10 ± 0.5 seconds Recovery time: 24 ± 2 hours	Dissolution of the end face plating shall not exceed 25% of the length of the edge concerned
			$\Delta C/C$ NPO: Within $\pm 1\%$ or 0.5 pF, whichever is greater. X7R/X7S: $\pm 10\%$
			D.F. within initial specified value
			IR within initial specified value
12	Thermal Shock	1. Preconditioning, class 2 only: 150 ± 10 °C / 1 hour, then keep for 24 ± 1 hour at room temp 2. Initial measure: Spec: refer to initial spec C, D, IR 3. Rapid change of temperature test: -55 °C to +125 °C; 300 cycles 15 minutes at -55 °C ; 15 minutes at 125 °C 4. Recovery time: NPO: 6 to 24 hours X7R/X7S 24 ± 2 hours 5. Final measure: C, D, IR	No visual damage
			$\Delta C/C$ NPO: Within $\pm 1\%$ or 1 pF, whichever is greater X7R/X7S: $\pm 15\%$
			D.F: meet initial specified value
			IR meet initial specified value

<p>13</p>	<p>ESD</p>	<p>Per AEC-Q200-002</p>	<p>A component passes a voltage level if all components stressed at that voltage level pass.</p>
<p style="text-align: right;">YNM0053-1</p> <p>Note: Classify the components according to the highest ESD voltage level survived during ESD testing.</p> <p>Fig. 4 Passive component HBM ESD test flow diagram (DC = Direct Contact Discharge, AD = Air Discharge)</p>			
<p>14</p>	<p>Solderability</p>	<ol style="list-style-type: none"> Preheat at 155°C for 4 hours. After preheating, immerse the capacitor in a solution of ethanol and rosin (25% rosin in weight proportion). Immerse in eutectic solder solution for 5+0/-0.5 seconds at 235±5°C. Should be placed into steam aging for 8 hours±15 minutes. After preheating, immerse the capacitor in a solution of ethanol and rosin (25% rosin in weight proportion). Immerse in eutectic solder solution for 5+0/-0.5 seconds at 235±5°C. Should be placed into steam aging for 8 hours±15 minutes. After preheating, immerse the capacitor in a solution of Ethanol and rosin (25% rosin in weight proportion). Immerse in eutectic solder solution for 120±5 seconds at 260±5°C. 	<p>The solder should cover over 95% of the critical area of each termination.</p>

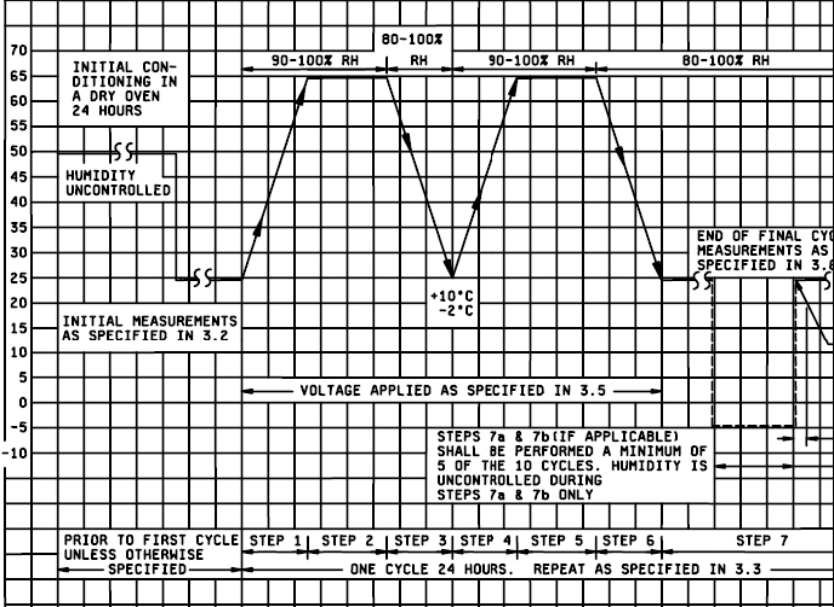
15	Electrical Characterization	Capacitance	<p>NPO: $f = 1 \text{ MHz}$ for $C \leq 1 \text{ nF}$, measuring at voltage $1 V_{\text{rms}}$ at 25°C $f = 1 \pm 0.1 \text{ KHz}$ for $C > 1 \text{ nF}$, measuring at voltage $1 \pm 0.2 V_{\text{rms}}$ at 25°C</p> <p>X7R/X7S: At 25°C, 24 hours after annealing $f = 1 \pm 0.1 \text{ KHz}$, measuring at voltage $1 \pm 0.2 V_{\text{rms}}$ at 25°C</p>	Within specified tolerance										
		Dissipation Factor (D.F.)	<p>NPO: $f = 1 \text{ MHz}$ for $C \leq 1 \text{ nF}$, measuring at voltage $1 V_{\text{rms}}$ at 25°C $f = 1 \pm 0.1 \text{ KHz}$ for $C > 1 \text{ nF}$, measuring at voltage $1 \pm 0.2 V_{\text{rms}}$ at 25°C</p> <p>X7R/X7S: At 25°C, 24 hours after annealing $f = 1 \pm 0.1 \text{ KHz}$, measuring at voltage $1 \pm 0.2 V_{\text{rms}}$ at 25°C</p>	In accordance with specification on Table 9										
		Insulation Resistance (I.R.)	At U_r (DC) for 1 minute	In accordance with specification on Table 9										
		Temperature coefficient	<p>Capacitance shall be measured by the steps shown in the following table. The capacitance change should be measured after 5 min at each specified temperature stage.</p> <table border="1" style="margin-left: 20px;"> <thead> <tr> <th>Step</th> <th>Temperature($^\circ\text{C}$)</th> </tr> </thead> <tbody> <tr> <td>a</td> <td>25 ± 2</td> </tr> <tr> <td>b</td> <td>Lower temperature $\pm 3^\circ\text{C}$</td> </tr> <tr> <td>c</td> <td>25 ± 2</td> </tr> <tr> <td>d</td> <td>Upper Temperature $\pm 2^\circ\text{C}$</td> </tr> <tr> <td>e</td> <td>25 ± 2</td> </tr> </tbody> </table> <p>(1) NPO Temperature Coefficient shall be calculated from the formula as below $\text{Temp. Coefficient} = \frac{C2 - C1}{C1 \times \Delta T} \times 10^6 \text{ [ppm/}^\circ\text{C]}$ C1: Capacitance at step c C2: Capacitance at 125°C $\Delta T: 100^\circ\text{C} (=125^\circ\text{C} - 25^\circ\text{C})$</p> <p>(2) X7R/X7S Capacitance Change shall be calculated from the formula as below $\Delta C = \frac{C2 - C1}{C1} \times 100\%$ C1: Capacitance at step c C2: Capacitance at step b or d</p>	Step	Temperature($^\circ\text{C}$)	a	25 ± 2	b	Lower temperature $\pm 3^\circ\text{C}$	c	25 ± 2	d	Upper Temperature $\pm 2^\circ\text{C}$	e
Step	Temperature($^\circ\text{C}$)													
a	25 ± 2													
b	Lower temperature $\pm 3^\circ\text{C}$													
c	25 ± 2													
d	Upper Temperature $\pm 2^\circ\text{C}$													
e	25 ± 2													
Voltage Proof	<ol style="list-style-type: none"> 1. Specified stress voltage applied for 1~5 seconds 2. $U_r \leq 100 \text{ V}$: series applied $2.5 U_r$ 3. $100 \text{ V} < U_r \leq 200 \text{ V}$ series applied $(1.5 U_r + 100)$ 4. $200 \text{ V} < U_r \leq 500 \text{ V}$ series applied $(1.3 U_r + 100)$ 5. $U_r > 500 \text{ V}$: $1.3 U_r$ 6. $U_r \geq 1000 \text{ V}$: $1.2 U_r$ Charge/Discharge current is less than 50 mA	No breakdown or flashover												

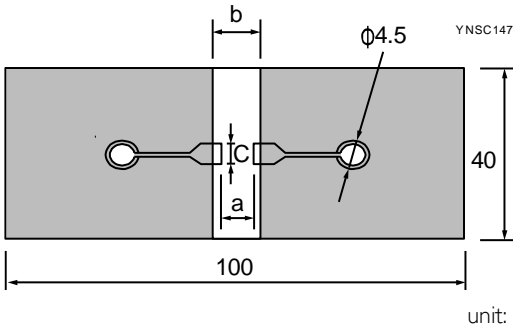
<p>16</p> <p>Board Flex</p>	<p>Part mounted on a 100mm × 40mm FR4 PCB board, which is 1.6±0.2 mm thick and has a layer-thickness 35µm±10 µm. Part should be mounted using the following soldering reflow profile.</p> <p>Conditions:</p> <p>NPO: Bending 3 mm at a rate of 1 mm/s, radius jig 340 mm</p> <p>X7R/X7S: Bending 2 mm at a rate of 1 mm/s, radius jig 340 mm</p> <p>Test Substrate:</p>	 <p style="text-align: right;">unit: mm</p>	<p>No visual damage</p> <p>ΔC/C</p> <p>NPO: Within ±1% or 0.5 pF, whichever is greater</p> <p>X7R/X7S: ±10%</p> <table border="1" data-bbox="1152 618 1437 1043"> <thead> <tr> <th rowspan="2">Type</th> <th colspan="3">Dimension(mm)</th> </tr> <tr> <th>a</th> <th>b</th> <th>c</th> </tr> </thead> <tbody> <tr> <td>0201</td> <td>0.3</td> <td>0.9</td> <td>0.3</td> </tr> <tr> <td>0402</td> <td>0.4</td> <td>1.5</td> <td>0.5</td> </tr> <tr> <td>0603</td> <td>1.0</td> <td>3.0</td> <td>1.2</td> </tr> <tr> <td>0805</td> <td>1.2</td> <td>4.0</td> <td>1.65</td> </tr> <tr> <td>1206</td> <td>2.2</td> <td>5.0</td> <td>1.65</td> </tr> <tr> <td>1210</td> <td>2.2</td> <td>5.0</td> <td>2.0</td> </tr> <tr> <td>1808</td> <td>3.5</td> <td>7.0</td> <td>3.7</td> </tr> </tbody> </table>	Type	Dimension(mm)			a	b	c	0201	0.3	0.9	0.3	0402	0.4	1.5	0.5	0603	1.0	3.0	1.2	0805	1.2	4.0	1.65	1206	2.2	5.0	1.65	1210	2.2	5.0	2.0	1808	3.5	7.0	3.7
Type	Dimension(mm)																																					
	a	b	c																																			
0201	0.3	0.9	0.3																																			
0402	0.4	1.5	0.5																																			
0603	1.0	3.0	1.2																																			
0805	1.2	4.0	1.65																																			
1206	2.2	5.0	1.65																																			
1210	2.2	5.0	2.0																																			
1808	3.5	7.0	3.7																																			
<p>17</p> <p>Terminal Strength</p>	<p>With the component mounted on a PCB obtained with the device to be tested, apply a 17.7N (1.8Kg) force to the side of a device being tested.</p> <p>This force shall be applied for 60+1 seconds.</p> <p>Also the force shall be applied gradually as not to apply a shock to the component being tested.</p> <p>* Apply 2N force for 0402 size.</p> <p>* Apply 1N force for 0201 size.</p>	<p>Magnification of 20X or greater may be employed for inspection of the mechanical integrity of the device body, terminals and body/terminal junction.</p> <p>Before, during and after the test, the device shall comply with all electrical requirements stated in this specification.</p>	<p>≤ 0805</p> <p>Thickness > 0.5mm: 20N</p> <p>Thickness ≤ 0.5mm: 8N</p> <p>≥ 1206</p> <p>Thickness ≥ 1.25 mm: 54N</p> <p>Thickness < 1.25 mm: 15N</p>																																			
<p>18</p> <p>Beam Load Test</p>	<p>Place the part in the beam load fixture. Apply a force until the part breaks or the minimum acceptable force level required in the user specification(s) is attained.</p>	<p>≤ 0805</p> <p>Thickness > 0.5mm: 20N</p> <p>Thickness ≤ 0.5mm: 8N</p> <p>≥ 1206</p> <p>Thickness ≥ 1.25 mm: 54N</p> <p>Thickness < 1.25 mm: 15N</p>	<p>≤ 0805</p> <p>Thickness > 0.5mm: 20N</p> <p>Thickness ≤ 0.5mm: 8N</p> <p>≥ 1206</p> <p>Thickness ≥ 1.25 mm: 54N</p> <p>Thickness < 1.25 mm: 15N</p>																																			

THICKNESS CLASSES AND PACKING QUANTITY

Table 12

SIZE CODE	THICKNESS CLASSIFICATION	PACKING CODE		TAPE WIDTH	QUANTITY PER REEL			
		7 INCH	13 INCH		Ø180 MM / 7 INCH		Ø330 MM / 13 INCH	
					Paper	Blister	Paper	Blister
0201	0.3 ±0.03 mm	R	P	8 mm	15,000	---	50,000	---
0402	0.5 ±0.05 mm	R	P	8 mm	10,000	---	50,000	---
0603	0.8 ±0.1 mm	R	P	8 mm	4,000	---	15,000	---
0805	0.6 ±0.1 mm	R	P	8 mm	4,000	---	20,000	---
	0.85 ±0.1 mm	R	P	8 mm	4,000	---	15,000	---
	1.25 ±0.2 mm	K	F	8 mm	---	3,000	---	10,000
1206	0.6 ±0.1 mm	R	P	8 mm	4,000	---	20,000	---
	0.85 ±0.1 mm	R	P	8 mm	4,000	---	15,000	---
	1.0/1.15 ±0.1 mm	K	F	8 mm	---	3,000	---	10,000
	1.25 ±0.2 mm	K	F	8 mm	---	3,000	---	10,000
	1.60 ±0.2 mm	K	F	8 mm	---	2,000	---	8,000
1210	0.85 ±0.1 mm	K	F	8 mm	---	4,000	---	10,000
	1.15 ±0.1 mm	K	F	8 mm	---	3,000	---	10,000
	1.25 ±0.2 mm	K	F	8 mm	---	3,000	---	10,000
	2.0 ±0.2 mm	K		8 mm	---	2,000	---	---
	2.5 ±0.2 mm	K		8 mm	---	1,000	---	---
1812	0.6 / 0.85±0.1 mm	K		12 mm	---	2,000	---	---
	1.15±0.1 mm	K		12 mm	---	1,000	---	---
	1.25±0.2 mm	K		12 mm	---	1,000	---	---
	1.6 ±0.2 mm	K		12 mm	---	2,000	---	---

PAPER/PE TAPE SPECIFICATION

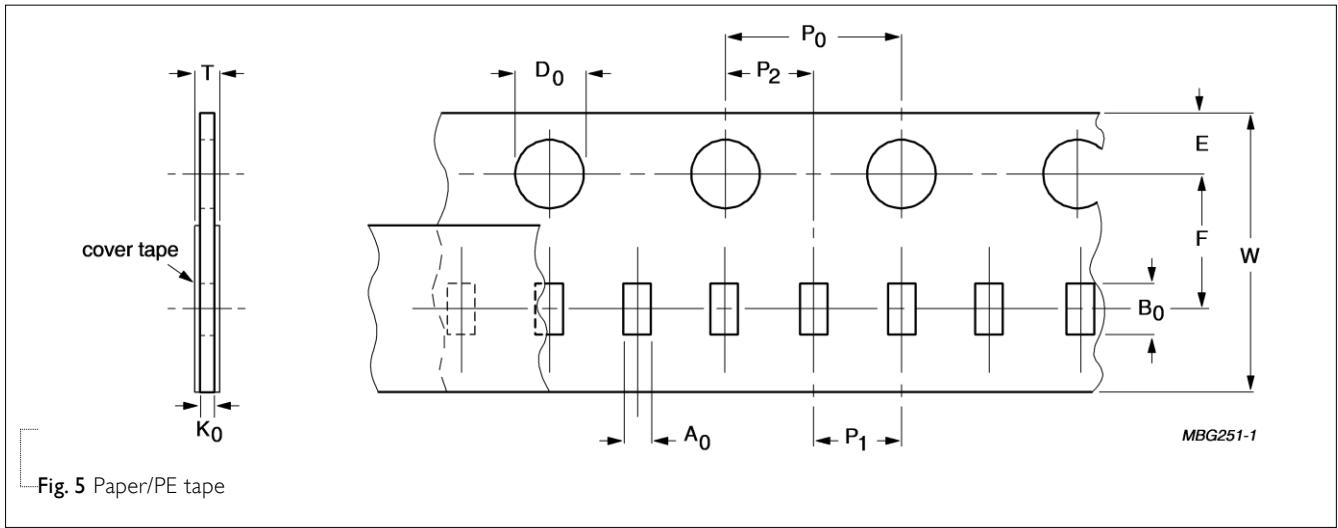

Fig. 5 Paper/PE tape

Table 13 Dimensions of paper/PE tape for relevant chip size; see Fig.5

SIZE	SYMBOL											Unit: mm
CODE	A0	B0	W	E	F	P0 (I)	P1	P2	ØD0	K0	T	
0201	0.39 ±0.06	0.70 ±0.06	8.0 ±0.20	1.75 ±0.1	3.50 ±0.05	4.0 ±0.05	2.0 ±0.05	2.0 ±0.05	1.55 ±0.03	0.38 ±0.05	(0.47/ 0.55)±0.10	
0402	0.70 ±0.15	1.21 ±0.12	8.0 ±0.20	1.75 ±0.1	3.50 ±0.05	4.0 ±0.05	2.0 ±0.05	2.0 ±0.05	1.50 +0.1 /-0	(0.75/ 0.60)±0.10	(0.85/ 0.70)±0.10	
0603	1.05 ±0.14	1.86 ±0.13	8.0 ±0.20	1.75 ±0.1	3.50 ±0.05	4.0 ±0.10	4.0 ±0.10	2.0 ±0.05	1.50 +0.1 /-0	(1.05/0.95/ 0.75)±0.10	(1.15/ 1.05/ 0.85)±0.10	
0805	1.50 ±0.15	2.26 ±0.20	8.0 ±0.20	1.75 ±0.1	3.50 ±0.05	4.0 ±0.10	4.0 ±0.10	2.0 ±0.05	1.50 +0.1 /-0	(1.05/0.95/ 0.75)±0.10	(1.15/ 1.05/ 0.85)±0.10	
1206	1.90 ±0.15	3.50 ±0.20	8.0 ±0.20	1.75 ±0.1	3.50 ±0.05	4.0 ±0.10	4.0 ±0.10	2.0 ±0.05	1.50 +0.1 /-0	(0.95/ 0.75)±0.10	(1.05/ 0.85)± 0.10	

NOTE

1. P₀ pitch tolerance over any 10 pitches is ±0.2 mm

BLISTER TAPE SPECIFICATION

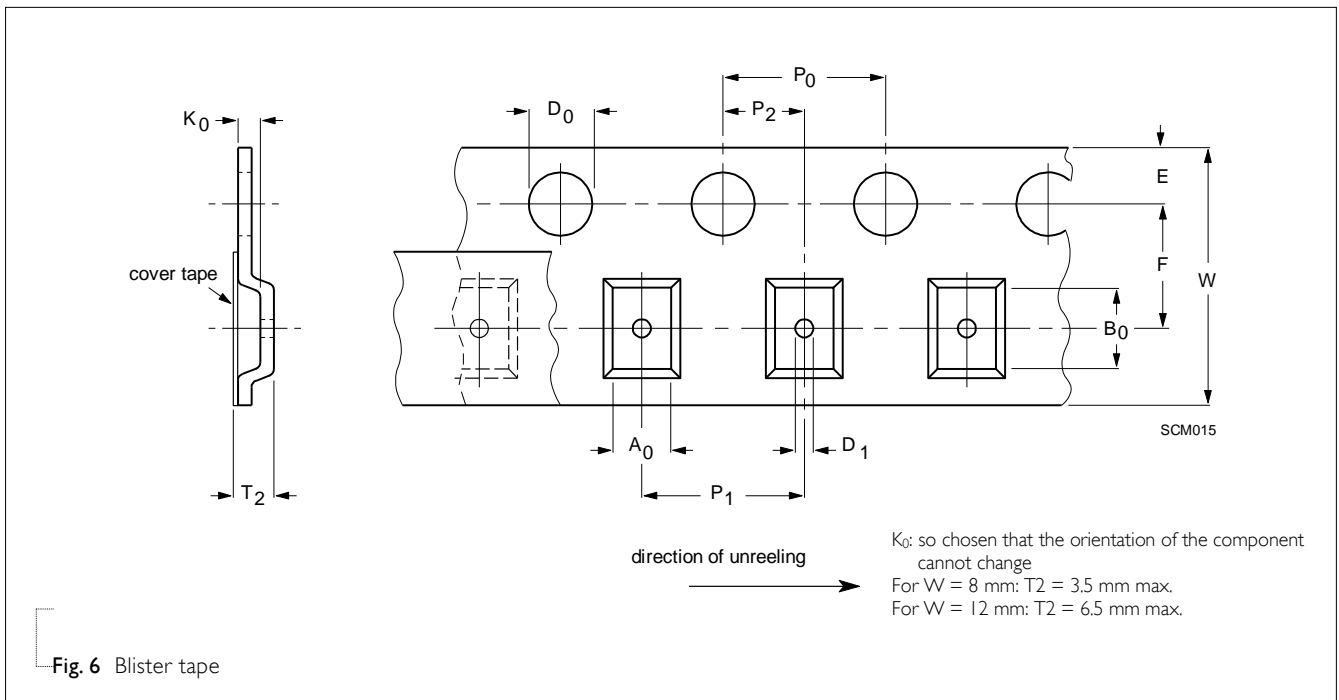

Fig. 6 Blister tape

Table 14 Dimensions of blister tape for relevant chip size; see Fig.6

SIZE CODE	SYMBOL												Unit: mm			
	A_0		B_0		K_0		W	E	F	$\varnothing D_0$	$\varnothing D_1$	$P_0^{(2)}$	P_1	P_2	T_2	
	Min.	Max.	Min.	Max.	Min.	Max.					Min.				Min.	Max.
0805	1.29	1.65	2.09	2.60	1.25	1.62	8.1 ± 0.20	1.75 ± 0.1	3.5 ± 0.05	$1.5 +0.1/-0.0$	$1.5 +0.1/-0.0$	4.0 ± 0.10	4.0 ± 0.10	2.0 ± 0.05	1.30	1.67
1206	1.65	2.12	3.30	3.75	1.22	2.15	8.1 ± 0.20	1.75 ± 0.1	3.5 ± 0.05	$1.5 +0.1/-0.0$	$1.5 +0.1/-0.0$	4.0 ± 0.10	4.0 ± 0.10	2.0 ± 0.05	1.27	2.20
1210	2.55	3.02	3.31	3.88	0.97	2.92	8.1 ± 0.20	1.75 ± 0.1	3.5 ± 0.05	$1.5 +0.1/-0.0$	$1.5 +0.1/-0.0$	4.0 ± 0.10	4.0 ± 0.10	2.0 ± 0.05	1.02	2.97
1808	2.05	2.55	4.80	5.45	1.30	2.45	12.1 ± 0.20	1.75 ± 0.1	5.5 ± 0.05	$1.5 +0.1/-0.0$	$1.5 +0.1/-0.0$	4.0 ± 0.10	4.0 ± 0.10	2.0 ± 0.05	1.35	2.50
1812	3.35	3.75	4.70	5.33	0.70	2.40	12.1 ± 0.20	1.75 ± 0.1	5.5 ± 0.05	$1.5 +0.1/-0.0$	$1.5 +0.1/-0.0$	4.0 ± 0.10	8.0 ± 0.10	2.0 ± 0.05	0.75	2.45

NOTE

1. Typical capacitor displacement in pocket
2. P_0 pitch tolerance over any 10 pitches is $\pm 0.2 \text{ mm}$

REEL SPECIFICATION

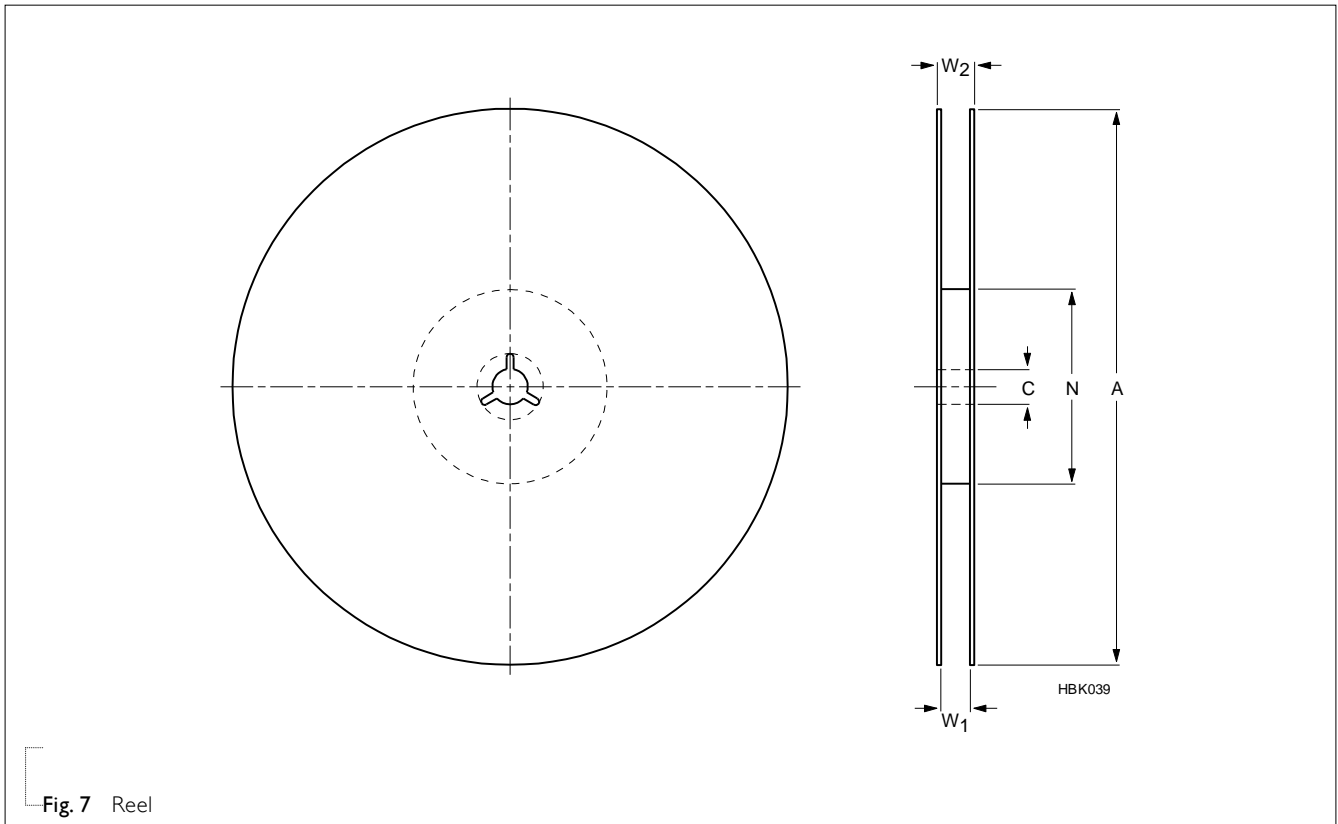

Fig. 7 Reel

Table 15 Reel dimensions; see Fig. 7

TAPE WIDTH	SYMBOL					Unit: mm
	A	N	C	W_1	W_{2max}	
8 (Ø178 mm/7")	178 ±1.0	60 ±1.0	13 +0.50/-0.20	9.4 ±1.5	14.4	
8 (Ø330 mm/13")	330 ±1.0	100 ±1.0	13 +0.50/-0.20	9.0 ±0.2	14.4	
12 (Ø178 mm/7")	178 ±1.0	60 ±1.0	13 +0.50/-0.20	13.4 ±1.5	18.4	

PROPERTIES OF REEL

Material: polystyrene

Surface resistance: $<10^{10}$ X/sq.

MOUNTING

SOLDER REPAIRS

Conventional solder repairs are carried out with a soldering iron as shown as Tab.9 . The tip of the soldering iron should not directly touch the chip component to avoid thermal shock on the interface between termination and body during mounting, repairing or de-mounting processes. Ensure the termination solder has melted before removing the chip component.

Table 16 Recommended soldering iron condition

SIZE	Temp(°C)	DURATION (SEC.)	PREHEATING TEMP(°C)	ATMOSPHERE
0201/0402/0603/0805/1206	350 max.	3 max.	150 min.	air
1210/1808/1812/2220	280 max.	3 max.	150 min.	air

SOLDERING CONDITIONS

For normal use the capacitors may be mounted on printed-circuit boards or ceramic substrates by applying wave soldering, reflow soldering or conductive adhesive in accordance with IEC 61760-1 (Standard method for the specification of surface mounting components). For advised soldering profiles see Figs 8, 9, 10.

An improper combination of soldering, substrate and chip size can lead to a damaging of the component. The risk increases with the chip size and with temperature fluctuations (>100 °C).

Therefore, it is advised to use the smallest possible size and follow the dimensional recommendations given in Tables 8, 9 and 10 for reflow and wave soldering. More detailed information is available on request.



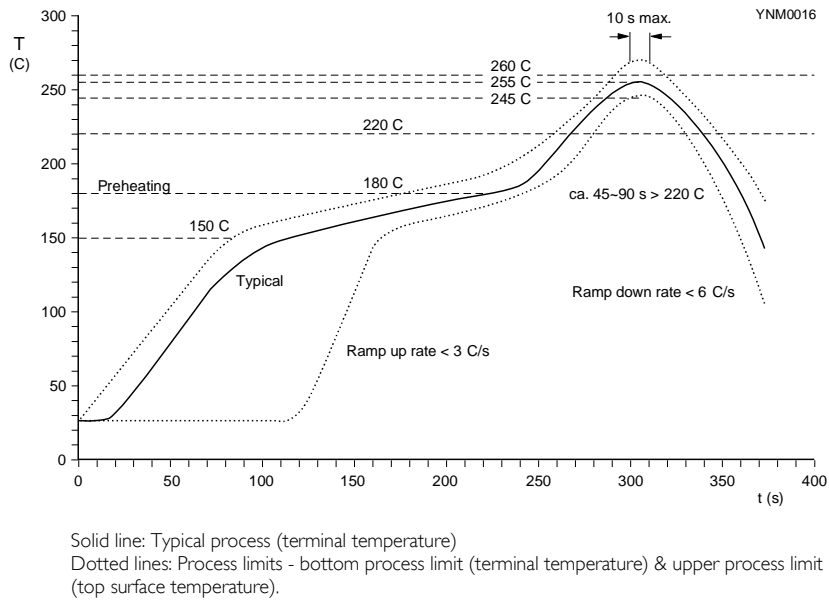

Fig. 9 Infrared soldering, forced gas convection reflow soldering - Temperature/time profile for lead-free SnAgCu solders

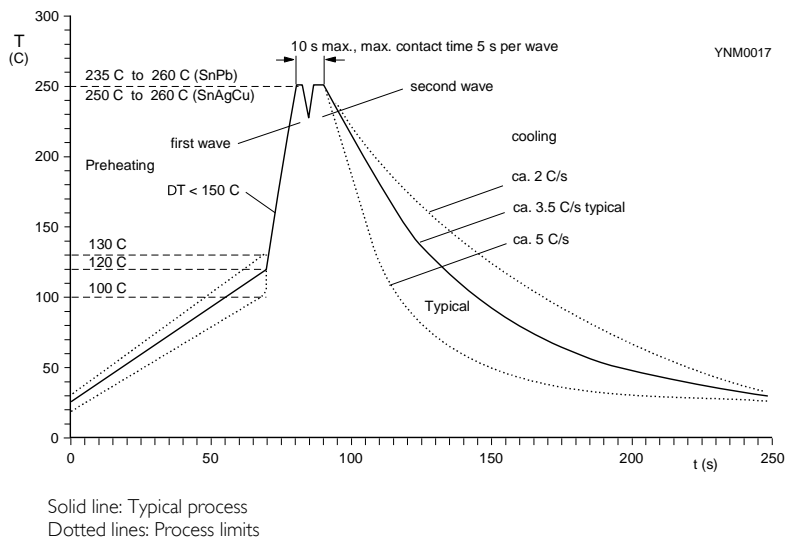

Fig. 10 Double wave soldering for SnPb and lead-free SnAgCu solder - Temperature/time profile (terminal temperature)

FOOTPRINT DIMENSIONS

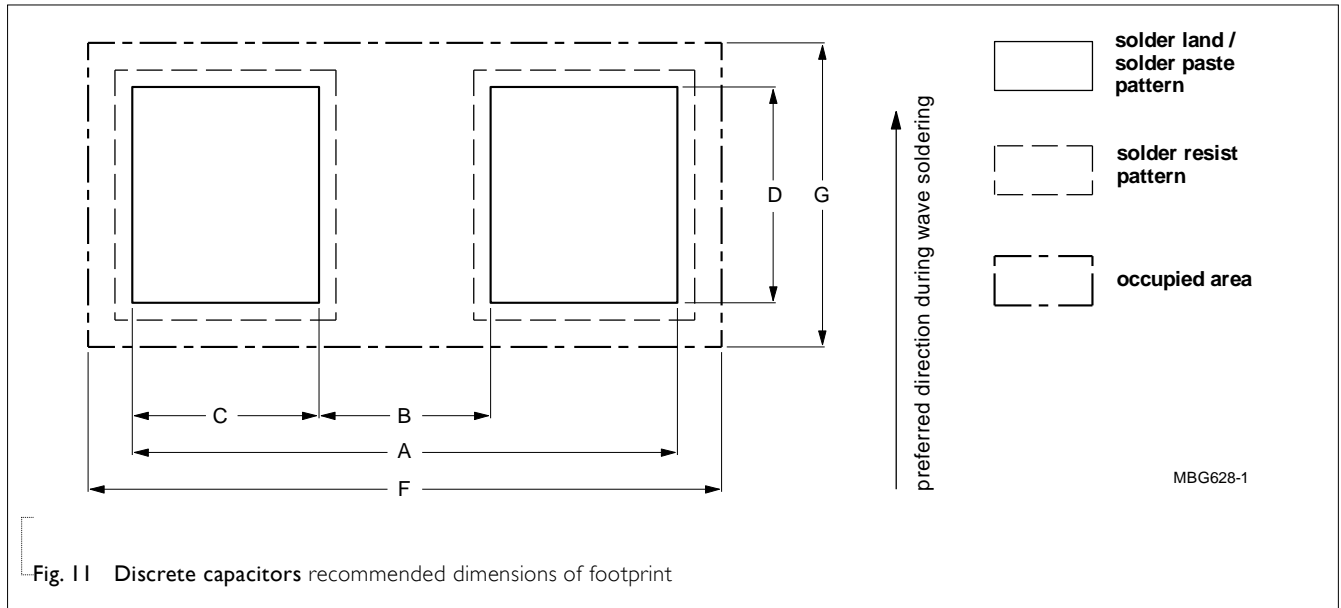

Fig. 11 Discrete capacitors recommended dimensions of footprint

Table 17 Reflow soldering; for footprint dimensions see Fig.11

SIZE CODE	FOOTPRINT DIMENSIONS						Unit: mm
	A	B	C	D	F	G	Processing remarks
0201	0.8 ±0.20	0.25 ±0.05	0.28 ±0.07	0.3 ±0.10	---	---	
0402	1.5 ±0.15	0.5 ±0.15	0.5 ±0.15	0.5 ±0.15	1.75 ±0.15	0.95 ±0.15	
0603	2.3 ±0.15	0.7 ±0.15	0.8 ±0.15	0.9 ±0.15	2.7 ±0.15	1.5 ±0.15	
0603	2.3 ±0.25	0.5 ±0.25	0.9 ±0.25	0.9 ±0.25	2.7 ±0.25	1.5 ±0.25	IR or hot plate soldering
0805	2.8 ±0.25	0.9 ±0.25	0.95 ±0.25	1.4 ±0.25	3.2 ±0.25	2.1 ±0.25	
1206	4.0 ±0.25	2.0 ±0.25	1.0 ±0.25	1.8 ±0.25	4.4 ±0.25	2.5 ±0.25	
1210	4.0 ±0.25	2.0 ±0.25	1.0 ±0.25	2.7 ±0.25	4.4 ±0.25	3.4 ±0.25	
1808	5.4 ±0.25	3.3 ±0.25	1.05 ±0.25	2.3 ±0.25	5.8 ±0.25	2.9 ±0.25	
1812	5.4 ±0.25	3.3 ±0.25	1.05 ±0.25	3.5 ±0.25	5.8 ±0.25	4.1 ±0.25	Ceramic substrate only
2220	6.6 ±0.25	4.5 ±0.25	1.05 ±0.25	5.3 ±0.25	7.0 ±0.25	5.9 ±0.25	

REVISION HISTORY

REVISION	DATE	CHANGE NOTIFICATION	DESCRIPTION
Version 21	May 21, 2024	-	- Add 1206/NPO/630V/1.2nF to 10nF; - Add 1210/630V/4.7nF to 33nF; - Add 1210/1000V/4.7nF to 22nF;
Version 20	Jan. 20, 2024	-	- Add 0402/X7R/100pF to 150pF/10V to 50V; - Add 0603/X7R/100pF to 680pF/10V to 100V; - Add 1206/X7R/220pF to 10nF/6.3V to 250V;
Version 19	Jul. 08, 2022	-	- Add 0805/NPO/500V 10pF to 470pF - Add 0805/NPO/630V 10pF to 180pF - Add 1210/NPO/50V~500V/47pF to 820pF
Version 18	Apr. 16, 2022	-	- Add 0402/X7S/10V~16V/150nF~220nF
Version 17	Jan. 14, 2022	-	- Add 1206/NPO/2000V/10pF to 47pF
Version 16	Nov. 17, 2021	-	- Add 1206/X7R/500V to 1000V/220pF to 1nF
Version 15	Oct. 12, 2021	-	- Add 0603/NPO/25V/50V/2.7nF to 10nF - I.R. for NPO change to "I.R. \geq 100 G Ω or I.R. \times C \geq 1000 Ω .F. whichever is less"
Version 14	Aug. 09, 2021	-	- Add 1206/NPO/1kV/10pF to 220pF 1206/X7R/1kV/1nF
Version 13	Jun. 08, 2021	-	- Move out "Array" and "High Cap" to individual specification Add 0603 NPO 50V/100V 1.2nF to 2.2nF 0402 X7R 50V 15nF to 100nF 0603 X7R 25V 330nF to 680nF 0603 X7R 50V 150nF to 220nF 0603 X7R 100V 68nF to 100nF
Version 12	Feb. 26, 2021	-	- Add 0201/ X7R/ 50V / 100 pF to 1nF 0603/ X7R/ 16V / 680nF to 1 μ F 0603/ X7R/ 25V / 150nF / 220nF/ 1 μ F 1210/ X7R/ 50V / 4.7 μ F
Version 11	Jun. 29, 2018	-	- Add 0201 NPO 25V/ 50V, 0.2pF to 33pF, Add 0402 NPO 50V 270pF to 1nF, Add 0805 X7R 25V 2.2uF
Version 10	May. 2, 2018	-	- Add 0603 NPO 100V 820pF to 1nF, - Add 0805 NPO 50V to 100V, 1.2nF to 10nF, - Add 0805 X7R 16V 2.2uF, 50V 680nF to 1uF, - Add 1206 X7R 100V 330nF to 2.2uF, 250V 33nF to 100nF
Version 9	Mar. 22, 2018	-	- Add 0402 X7R 100nF 25~50V
Version 8	Nov. 22, 2017	-	- Add X7R/0201/25V/100pF~10nF
Version 7	Jul. 7, 2017	-	- Add X7R/0805/330nF to 470nF/50V, X7R/1206/10uF/6.3V
Version 6	Mar. 31, 2017	-	- Add NPO/0603/1nF/50V, X7R/0603/1uF/10V, X7R/0603/470nF/16V, X7R/0603/220nF/25V
Version 5	Nov. 15, 2016	-	- Add Soldering Condition
Version 4	Jun. 14, 2016	-	- Add X7R/0805/2.2uF/10V and NPO/1206/1.2nF to 1.5nF/250V
Version 3	Jul. 21, 2015	-	- Tests and Requirements update
Version 2	Jul. 17, 2014	-	- Tests and Requirements update
Version 1	Apr. 19, 2013	-	- Capacitance range update
Version 0	Dec. 25, 2012	-	- New

LEGAL DISCLAIMER

YAGEO, its distributors and agents (collectively, "YAGEO"), hereby disclaims any and all liabilities for any errors, inaccuracies or incompleteness contained in any product related information, including but not limited to product specifications, datasheets, pictures and/or graphics. YAGEO may make changes, modifications and/or improvements to product related information at any time and without notice.



YAGEO makes no representation, warranty, and/or guarantee about the fitness of its products for any particular purpose or the continuing production of any of its products. To the maximum extent permitted by law, YAGEO disclaims (i) any and all liability arising out of the application or use of any YAGEO product, (ii) any and all liability, including without limitation special, consequential or incidental damages, and (iii) any and all implied warranties, including warranties of fitness for a particular purpose, non-infringement and merchantability.

YAGEO products are designed for general purpose applications under normal operation and usage conditions. Please contact YAGEO for the applications listed below which require especially high reliability for the prevention of defects which might directly cause damage to the third party's life, body or property: Aerospace equipment (artificial satellite, rocket, etc.), Atomic energy-related equipment, Aviation equipment, Disaster prevention equipment, crime prevention equipment, Electric heating apparatus, burning equipment, Highly public information network equipment, data-processing equipment, Medical devices, Military equipment, Power generation control equipment, Safety equipment, Traffic signal equipment, Transportation equipment and Undersea equipment, or for any other application or use in which the failure of YAGEO products could result in personal injury or death, or serious property damage.







Information provided here is intended to indicate product specifications only. YAGEO reserves all the rights for revising this content without further notification, as long as products are unchanged. Any product change will be announced by PCN.

Looking for pricing, stock, or lifecycle information?

Click below to explore more details on WIN SOURCE:

-  View [AC1206KKX7R0BB104](#) on WIN SOURCE
-  [Yageo](#) Information

Optimize Your Supply Chain with WIN SOURCE Solutions

-  Global Sourcing Solution
-  Obsolete Management
-  Cost Control Management
-  Shortage Management
-  Alternative Solution
-  Excess Inventory Management