



**THE DATASHEET OF
7V-24.000MAAV-T**



Features

- Frequency range : 8MHz to 54MHz
- Glass sealing, ceramic SMD package
- External dimensions (mm)
L : 3.2 x W : 2.5 x H : 0.8
- RoHS compliant
Contains Pb, exempted by RoHS directive

Applications

- PC, TV, Game, Camera
- Notebook, Hard disk
- Computer peripherals
- Home electronics
- Consumer products

Electrical Characteristics

Item		7V	Conditions
Frequency Range	F_0	8MHz ~ 54MHz	
Frequency Tolerance	F_{tol}	±30ppm, ±20ppm, ±10ppm	at 25°C
Frequency Stability over Operating Temperature Range (refer to 25°C)	F_{stab}	±30 ppm	-20°C ~ +70°C
		±20 ppm	
		±10 ppm	
		±10 ppm	-30°C ~ +85°C
		±50 ppm	-40°C ~ +85°C
		±30 ppm	
		±20 ppm	
±60 ppm	-40°C ~ +125°C		
Operating Temperature Range	T_{OTR}	-20°C ~ +70°C	
		-30°C ~ +85°C	
		-40°C ~ +85°C	
		-40°C ~ +125°C	
Shunt Capacitance	C_0	3pF Max.	
Drive Level	D_L	1 ~ 50μW (10μW Typ.)	
Load Capacitance	C_L	6pF, 7pF, 8pF, 9pF, 10pF 12pF, 16pF, 18pF, 20pF	
Aging	F_{aging}	±3 ppm Max.	at 25°C ± 3°C, first year
Storage Temperature Range	T_{STR}	-55°C ~ +125°C	

Motional Resistance (ESR)

Fundamental	
8 ~ 9 MHz	350Ω Max.
9 ~ 10 MHz	200Ω Max.
10 ~ 12 MHz	150Ω Max.
12 ~ 16 MHz	100Ω Max.
16 ~ 54 MHz	60Ω Max.

Dimensions

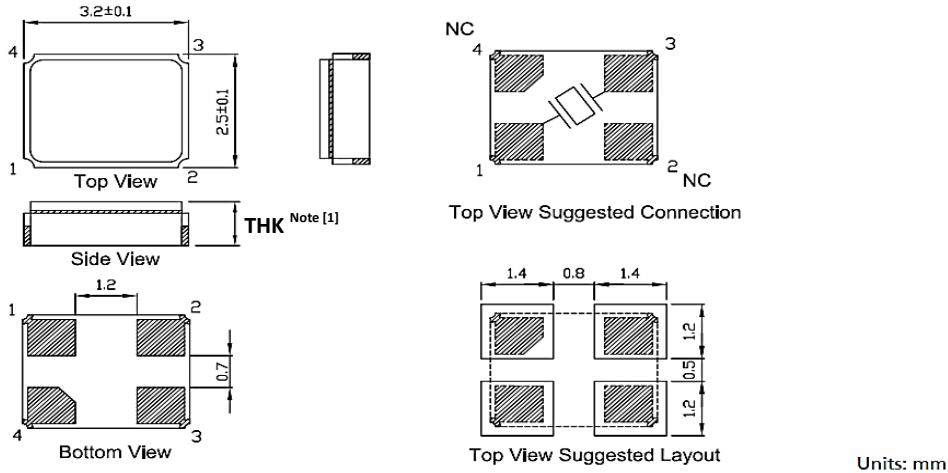

Note:

[1] THK = 0.8 ± 0.1mm except F₀ = 8MHz.
THK = 0.9 ± 0.1mm for F₀ = 8MHz.

Ordering Information

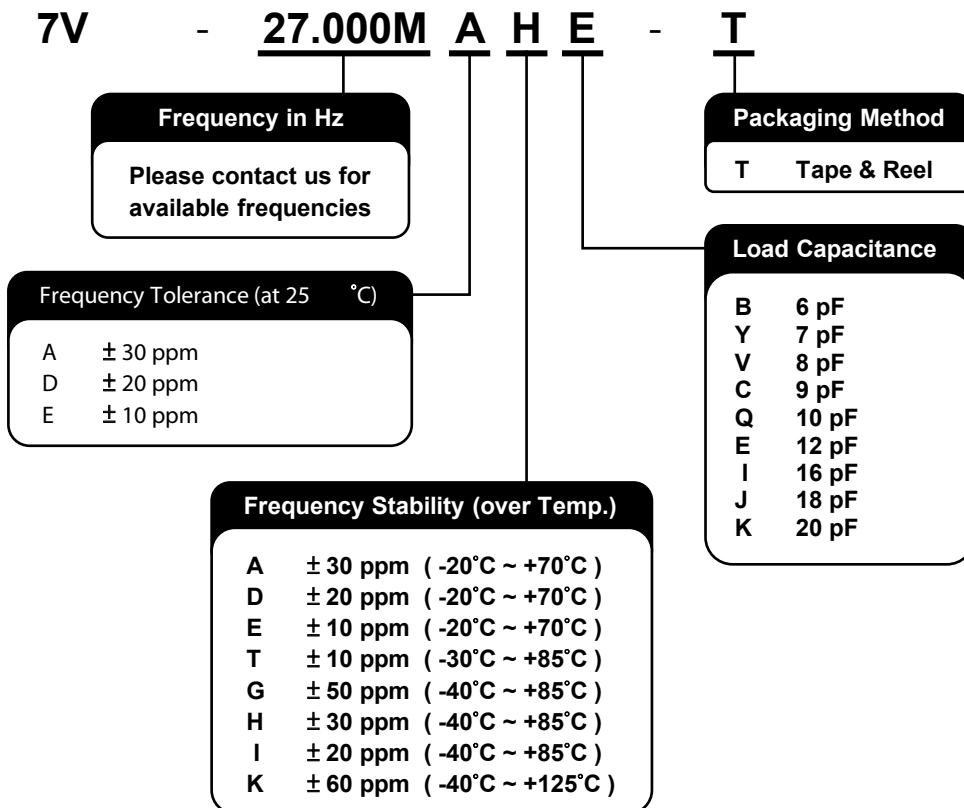

Packing

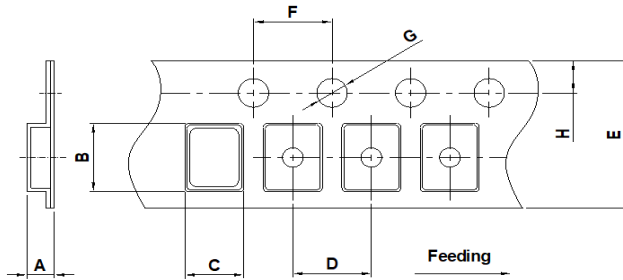

DIMENSIONS	A	B	C	D	E	F	G	H
	1.65±0.10	3.40±0.10	2.70±0.10	4.00±0.10	8.00±0.20	4.00±0.10	1.55±0.10	1.75±0.10

(Unit: mm)

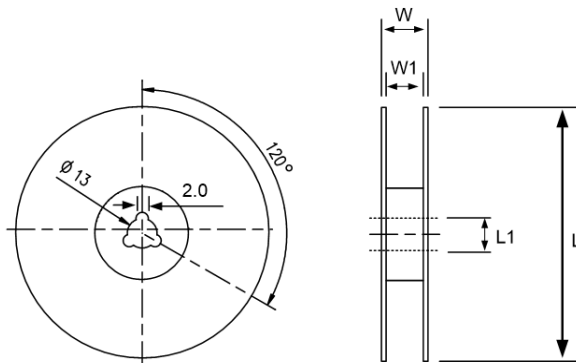

DIMENSIONS	L	L1	W	W1
	178±1.00	13±0.50	11.5±0.20	8±0.10

(Unit: mm)

Reflow Profile

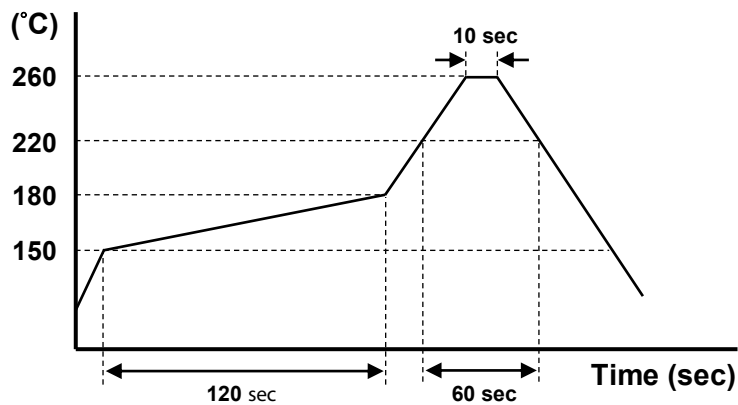

Solder melting point : 220°C ± 10°C, 60 sec. Min.

Peak temperature : 260°C ± 5°C, 10 sec. Min.



Looking for pricing, stock, or lifecycle information?

Click below to explore more details on WIN SOURCE:

-  [View 7V-24.000MAAV-T on WIN SOURCE](#)
-  [TXC CORPORATION](#) Information

Optimize Your Supply Chain with WIN SOURCE Solutions

-  Global Sourcing Solution
-  Obsolete Management
-  Cost Control Management
-  Shortage Management
-  Alternative Solution
-  Excess Inventory Management