



**THE DATASHEET OF**  
**14064**



# 14064 Datasheet

## Product Name // Insulation Boot 14064

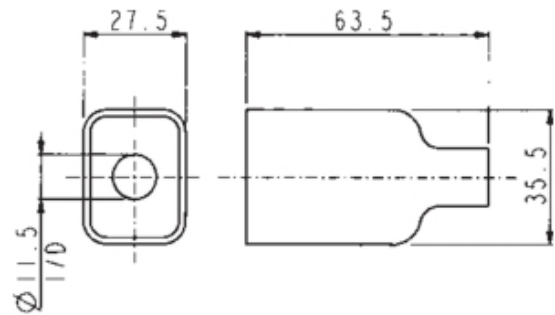
[View Product Page](#)

### // Product Description:

- ⊕ Insulation Boots
- ⊕ Protect rear of IEC Connectors
- ⊕ Protect against accidental electric shock
- ⊕ Suitable for the following connectors only:
- ⊕ 11328 for: PX0575, PX0579, PX0580, PX0590, PX0595
- ⊕ 11987 for: PF0001, PF0002, PF0006, PF0007, PF0011, PF0016 (except /PC PCB Mount versions)
- ⊕ 12075 for: PX0675, PX0695, PX0705, PX0725, PX0783, PX0793 (except /PC PCB Mount versions)
- ⊕ 14064 for C20 Inlets: PX0596, PX0598
- ⊕ 14317 for Fused Inlets: PF0030, PF0033 (except /PC PCB Mount versions)
- ⊕ 14340 for Mains Filtered Inlets: PS20, PS21, PS25, PS26

### // General Information:

Product Display Title:	Insulation Boots
Product Family:	IEC Connectors
Product Series:	IEC60320 Main Inlets and Outlets
Change Notes:	PRODUCT-MOQ-ADJUSTMENT
Body Material:	PVC
Flamability Rating:	UL94V-0
Function:	Accessory
iec Connector Mates With:	PX0596,PX0598
Max Operating Temperature:	+60°C
Min Operating Temperature:	-20°C
Rohs Compliant:	Yes

#### // Product PDF Links

[IEC Connectors product data](#)

#### // Product 3D CAD Model Links

[140643D CAD Model](#)





## Looking for pricing, stock, or lifecycle information?

Click below to explore more details on WIN SOURCE:

 [View 14064 on WIN SOURCE](#)

 [Bulgin Information](#)

## Optimize Your Supply Chain with WIN SOURCE Solutions

-  Global Sourcing Solution
-  Obsolete Management
-  Cost Control Management
-  Shortage Management
-  Alternative Solution
-  Excess Inventory Management