



**THE DATASHEET OF
C0603H470J5GAC**



High Temperature 200°C, COG Dielectric, 10 – 200 VDC (Industrial Grade)

Overview

KEMET's High Temperature surface mount COG Multilayer Ceramic Capacitors (MLCCs) are constructed of a robust and proprietary COG/NP0 base metal electrode (BME) dielectric system that offers industry-leading performance at extreme temperatures up to 200°C. These devices are specifically designed to withstand the demands of harsh industrial environments such as down-hole oil exploration and automotive/avionics engine compartment circuitry.

KEMET's High Temperature COG capacitors are temperature compensating and are well suited for resonant circuit applications or those where Q and stability of capacitance characteristics are required. They exhibit no change in capacitance with respect to time and voltage and boast a negligible change in capacitance with reference to ambient temperature. Capacitance change is limited to $\pm 30\text{ppm}/^\circ\text{C}$ from -55°C to $+200^\circ\text{C}$. In addition, these capacitors exhibit high insulation resistance with low dissipation factor at

elevated temperatures up to 200°C. They also exhibit low ESR at high frequencies and offer greater volumetric efficiency over competitive high temperature precious metal electrode (PME) and BME ceramic capacitor devices.

These devices are Lead (Pb)-Free, RoHS and REACH compliant without the need of any exemptions.



Ordering Information

| C | 1210 | H | 124 | J | 5 | G | A | C | TU |
|---------|--|------------------------------|--|---|--|------------|----------------------|---|---|
| Ceramic | Case Size (L" x W") | Specification/ Series | Capacitance Code (pF) | Capacitance Tolerance ¹ | Voltage | Dielectric | Failure Rate/ Design | Termination Finish ² | Packaging/ Grade (C-Spec) |
| | 0402 0603 0805 1206 1210 1812 2220 | H = High temperature (200°C) | Two significant digits + number of zeros. Use 9 for 1.0 – 9.9 pF Use 8 for 0.5 – 0.99 pF e.g., 2.2 pF = 229 e.g., 0.5 pF = 508 | B = ± 0.10 pF C = ± 0.25 pF D = ± 0.5 pF F = $\pm 1\%$ G = $\pm 2\%$ J = $\pm 5\%$ K = $\pm 10\%$ M = $\pm 20\%$ | 8 = 10 V 4 = 16 V 3 = 25 V 5 = 50 V 1 = 100 V 2 = 200 V | G = COG | A = N/A | C = 100% Matte Sn L = SnPb (5% Pb minimum) E = Gold (Au) 1.97 – 11.8 μin F = Gold (Au) 30 – 70 μin G = Gold (Au) 100 μin minimum | See "Packaging C-Spec Ordering Options Table" below |

¹ Additional capacitance tolerance offerings may be available. Contact KEMET for details.

² Additional termination finish options may be available. Contact KEMET for details.

Benefits

- -55°C to +200°C operating temperature range
- Lead (Pb)-free, RoHS and REACH compliant
- EIA 0402, 0603, 0805, 1206, 1210, 1812, and 2220 case sizes
- DC voltage ratings of 10 V, 16 V, 25 V, 50 V, 100 V, and 200 V
- Capacitance offerings ranging from 0.5 pF up to 470 nF
- Available capacitance tolerances of ± 0.10 pF, ± 0.25 pF, ± 0.5 pF, $\pm 1\%$, $\pm 2\%$, $\pm 5\%$, $\pm 10\%$ or $\pm 20\%$
- No piezoelectric noise
- Extremely low ESR and ESL
- High thermal stability
- High ripple current capability
- Preferred capacitance solution at line frequencies and into the MHz range
- No capacitance change with respect to applied rated DC voltage
- Negligible capacitance change with respect to temperature from -55°C to +200°C
- No capacitance decay with time
- Non-polar device, minimizing installation concerns
- 100% pure matte tin-plated termination finish allowing for excellent solderability
- Gold (Au), Tin/Lead (Sn/Pb) and 100% pure matte Tin (Sn) termination finishes available

Applications

Typical applications include critical timing, tuning, circuits requiring low loss, circuits with pulse, high current, decoupling, bypass, filtering, transient voltage suppression, blocking and energy storage for use in extreme environments such as down-hole exploration, aerospace engine compartments and geophysical probes.

Packaging C-Spec Ordering Options Table

| Termination Finish Options | Packaging Type/Options | Packaging Ordering Code (C-Spec) |
|--|-----------------------------|---|
| Standard Packaging – Unmarked³ | | |
| C = 100% Matte Sn L = SnPb (5% Pb min.) F = Gold (Au) 30 – 70 µin G = Gold (Au) 100 µin minimum | Bulk Bag | Blank ¹ |
| | Waffle Tray ² | 7292 |
| | 7" Tape & Reel | TU |
| | 13" Reel | 7411 (EIA 0603 and smaller case sizes) 7210 (EIA 0805 and larger case sizes) |
| | 7" Tape & Reel – 50 pieces | T050 |
| | 7" Tape & Reel – 100 pieces | T100 |
| | 7" Tape & Reel – 250 pieces | T250 |
| | 7" Tape & Reel – 500 pieces | T500 |
| 7" Tape & Reel – 1,000 pieces | T1K0 | |
| Moisture Sensitive Packaging⁴ – Unmarked³ | | |
| E = Gold (Au) 1.97 – 11.8 µin F = Gold (Au) 30 – 70 µin G = Gold (Au) 100 µin minimum | Waffle Tray ² | 7282 |
| | 7" Tape & Reel | 7130 |
| | 7" Tape & Reel – 50 pieces | Contact KEMET ⁵ |
| | 7" Tape & Reel – 100 pieces | |
| | 7" Tape & Reel – 250 pieces | |
| | 7" Tape & Reel – 500 pieces | |
| 7" Tape & Reel – 1,000 pieces | | |

¹ Default packaging is "Bulk Bag". An ordering code C-Spec is not required for "Bulk Bag" packaging.

¹ "Bulk Bag" packaging option is not available for Gold (Au) termination finish options and case sizes larger than 2225 (5664 Metric).

² "Waffle Tray" packaging option is not available for case sizes larger than 2225 (5664 Metric).

³ The terms "Marked" and "Unmarked" pertain to laser marking option of components. All packaging options labeled as "Unmarked" will contain capacitors that have not been laser marked. The option to laser mark is not available on these devices.

³ Reeling quantities are dependent upon chip size and thickness dimension. When ordering using the "T1K0" packaging option, 1812 through 2225 case size devices with chip thickness of ≥ 1.9 mm (nominal) may be shipped on multiple 7" reels or a single 13" reel. Additional reeling or packaging options may be available. Contact KEMET for details.

⁴ Moisture sensitive packaging is required for Gold (Au) termination option "E" (1.97 – 11.8 µin)

⁵ Additional reeling or packaging options may be available. Contact KEMET for details.

Dimensions – Millimeters (Inches)



| EIA Size Code | Metric Size Code | L Length | W Width | T Thickness | B Bandwidth | S Separation Minimum | Mounting Technique |
|---------------|------------------|-------------------------------|-------------------------------|---------------------------|-------------------------------|----------------------|------------------------------|
| 0402 | 1005 | 1.00 (0.040) ±0.05 (0.002) | 0.50 (0.020) ±0.05 (0.002) | See Table 2 for Thickness | 0.30 (0.012) ±0.10 (0.004) | 0.30 (0.012) | Solder Reflow Only |
| 0603 | 1608 | 1.60 (0.063) ±0.15 (0.006) | 0.80 (0.032) ±0.15 (0.006) | | 0.35 (0.014) ±0.15 (0.006) | 0.50 (0.020) | Solder Wave or Solder Reflow |
| 0805 | 2012 | 2.00 (0.079) ±0.20 (0.008) | 1.25 (0.049) ±0.20 (0.008) | | 0.50 (0.02) ±0.25 (0.010) | 0.70 (0.028) | |
| 1206 | 3216 | 3.20 (0.126) ±0.20 (0.008) | 1.60 (0.063) ±0.20 (0.008) | | 0.50 (0.02) ±0.25 (0.010) | 1.50 (0.060) | Solder Reflow Only |
| 1210 | 3225 | 3.20 (0.126) ±0.20 (0.008) | 2.50 (0.098) ±0.20 (0.008) | | 0.50 (0.02) ±0.25 (0.010) | 1.50 (0.060) | |
| 1812 | 4532 | 4.50 (0.177) ±0.30 (0.012) | 3.20 (0.126) ±0.30 (0.012) | | 0.60 (0.024) ±0.35 (0.014) | 2.30 (0.091) | |
| 2220 | 5650 | 5.70 (0.224) ±0.40 (0.016) | 5.00 (0.197) ±0.40 (0.016) | | 0.60 (0.024) ±0.35 (0.014) | 3.50 (0.138) | |

Qualification/Certification

High temperature (200°C) Industrial grade products meet or exceed the requirements outlined in Table 4, Performance & Reliability. Qualification packages are available for review and download on our website at www.kemet.com/hightemp

Environmental Compliance

Lead (Pb)-free, RoHS, and REACH compliant without exemptions (excluding SnPb termination finish option).

Electrical Parameters/Characteristics

| Item | Parameters/Characteristics |
|--|---|
| Operating Temperature Range | -55°C to +200°C |
| Capacitance Change with Reference to +25°C and 0 VDC Applied (TCC) | ±30 ppm/°C (up to 200°C) |
| Aging Rate (Maximum % Capacitance Loss/Decade Hour) | 0% |
| ¹ Dielectric Withstanding Voltage (DWV) | 250% of rated voltage (5±1 seconds and charge/discharge not exceeding 50 mA) |
| ² Dissipation Factor (DF) Maximum Limit at 25°C | 0.1% |
| ³ Insulation Resistance (IR) Minimum Limit at 25°C | 1,000 megohm microfarads or 100 GΩ (Rated voltage applied for 120±5 seconds at 25°C) |

¹ DWV is the voltage a capacitor can withstand (survive) for a short period of time. It exceeds the nominal and continuous working voltage of the capacitor.

² Capacitance and dissipation factor (DF) measured under the following conditions:

1 MHz ±100 kHz and 1.0 ±0.2 Vrms if capacitance ≤ 1,000 pF

1 kHz ±50 Hz and 1.0 ±0.2 Vrms if capacitance > 1,000 pF

³ To obtain IR limit, divide MQ-μF value by the capacitance and compare to GΩ limit. Select the lower of the two limits.

Note: When measuring capacitance it is important to ensure the set voltage level is held constant. The HP4284 & Agilent E4980 have a feature known as Automatic Level Control (ALC). The ALC feature should be switched to "ON."

Post Environmental Limits

| High Temperature Life, Biased Humidity, Moisture Resistance | | | | | |
|---|------------------|-------------------|--------------------------------|-------------------|-----------------------|
| Dielectric | Rated DC Voltage | Capacitance Value | Dissipation Factor (Maximum %) | Capacitance Shift | Insulation Resistance |
| COG | All | All | 0.5 | 0.3% or ±0.25 pF | 10% of Initial Limit |

Electrical Characteristics

Delta Cap vs. Temperature (Typical)

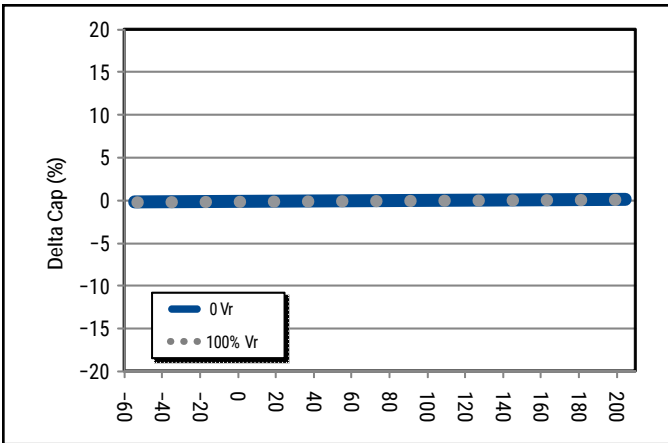

C1210H104J1GAC - Life Test IR Distribution (Lognormal)

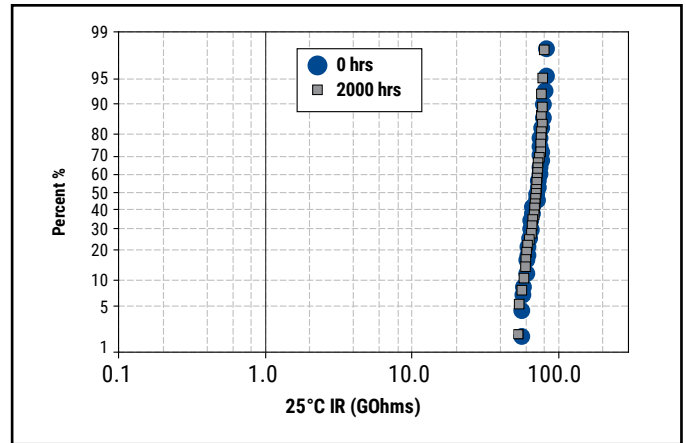

Capacitance vs. Temperature with 25 V DC Bias (Rated Voltage)

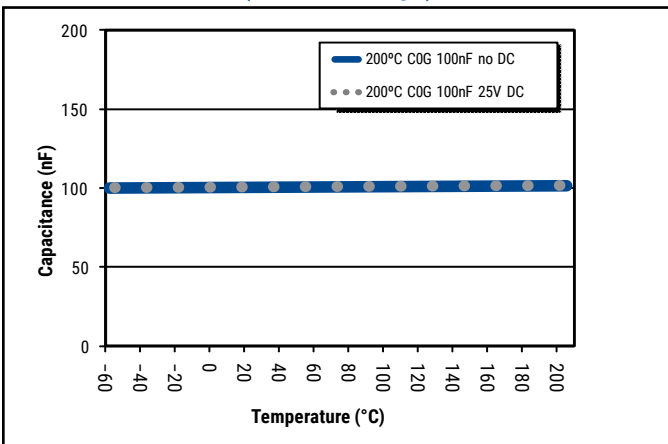

DF vs. Temperature without DC Bias.

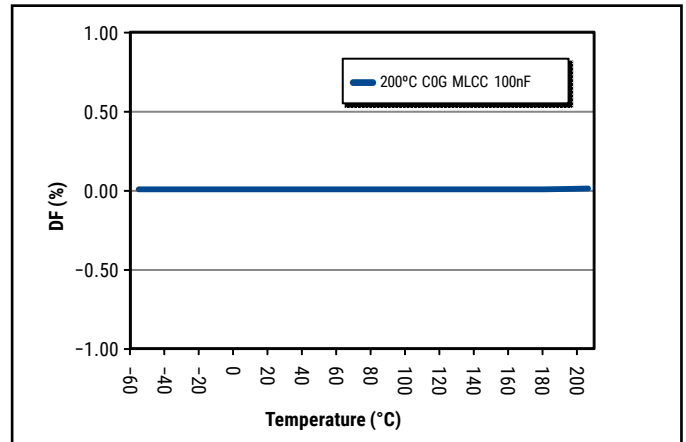

IR vs. Temperature with 25 V DC Bias (Rated Voltage)

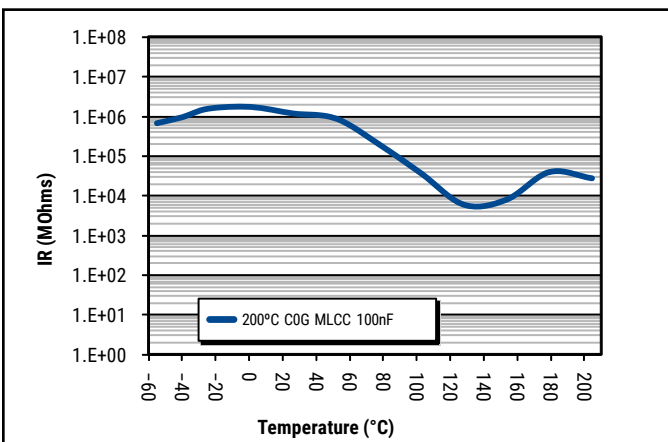

BME vs. PME/IR vs. Temperature with 25 V DC Bias (Rated Voltage)

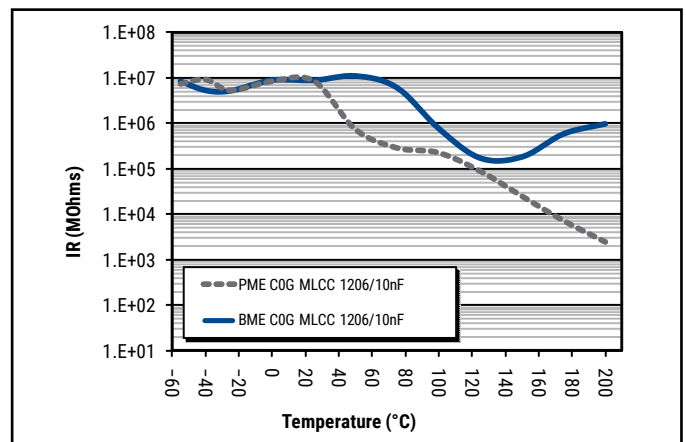

Table 1A – Capacitance Range/Selection Waterfall (0402 – 1206 Case Sizes)

| Capacitance | Cap Code | Case Size / Series | | | C0402H | | | | | C0603H | | | | | | C0805H | | | | | | C1206H | | | | | | | | | | |
|---------------|------------|-----------------------|---|---|--|----|----|----|-----|--------|----|----|----|-----|-----|--------|----|----|----|-----|-----|--------|----|----|----|-----|-----|----|----|----|----|----|
| | | Voltage Code | | | 8 | 4 | 3 | 5 | 1 | 8 | 4 | 3 | 5 | 1 | 2 | 8 | 4 | 3 | 5 | 1 | 2 | 8 | 4 | 3 | 5 | 1 | 2 | | | | | |
| | | Rated Voltage (VDC) | | | 10 | 16 | 25 | 50 | 100 | 10 | 16 | 25 | 50 | 100 | 200 | 10 | 16 | 25 | 50 | 100 | 200 | 10 | 16 | 25 | 50 | 100 | 200 | | | | | |
| | | Capacitance Tolerance | | | Product Availability and Chip Thickness Codes See Table 2 for Chip Thickness Dimensions | | | | | | | | | | | | | | | | | | | | | | | | | | | |
| 0.5 & 0.75 pF | 508 & 758 | B | C | D | | | | | | BB | BB | BB | BB | | CF | CF | CF | CF | CF | CF | DN | DN | DN | DN | DN | DN | | | | | | |
| 1.0 - 9.0 pF* | 109 - 919* | B | C | D | | | | | | BB | BB | BB | BB | | CF | CF | CF | CF | CF | CF | DN | DN | DN | DN | DN | DN | EB | EB | EB | EB | EB | EB |
| 10 - 91 pF* | 100 - 910* | | | | F | G | J | K | M | BB | BB | BB | BB | | CF | CF | CF | CF | CF | CF | DN | DN | DN | DN | DN | DN | EB | EB | EB | EB | EB | EB |
| 100 - 180 pF* | 101 - 181* | | | | F | G | J | K | M | BB | BB | BB | BB | BB | CF | CF | CF | CF | CF | CF | DN | DN | DN | DN | DN | DN | EB | EB | EB | EB | EB | EB |
| 200 - 430 pF* | 201 - 431* | | | | F | G | J | K | M | BB | BB | BB | BB | BB | CF | CF | CF | CF | CF | CF | DN | DN | DN | DN | DN | DN | EB | EB | EB | EB | EB | EB |
| 470 pF | 471 | | | | F | G | J | K | M | BB | BB | BB | BB | BB | CF | CF | CF | CF | CF | CF | DN | DN | DN | DN | DN | DN | EB | EB | EB | EB | EB | EB |
| 510 pF | 511 | | | | F | G | J | K | M | BB | BB | BB | BB | BB | CF | CF | CF | CF | CF | CF | DN | DN | DN | DN | DN | DN | EB | EB | EB | EB | EB | EB |
| 560 pF | 561 | | | | F | G | J | K | M | BB | BB | BB | BB | BB | CF | CF | CF | CF | CF | CF | DN | DN | DN | DN | DN | DN | EB | EB | EB | EB | EB | EB |
| 620 pF | 621 | | | | F | G | J | K | M | BB | BB | BB | BB | BB | CF | CF | CF | CF | CF | CF | DN | DN | DN | DN | DN | DN | EB | EB | EB | EB | EB | EB |
| 680 pF | 681 | | | | F | G | J | K | M | BB | BB | BB | BB | BB | CF | CF | CF | CF | CF | CF | DN | DN | DN | DN | DN | DN | EB | EB | EB | EB | EB | EB |
| 750 pF | 751 | | | | F | G | J | K | M | BB | BB | BB | BB | BB | CF | CF | CF | CF | CF | CF | DN | DN | DN | DN | DN | DN | EB | EB | EB | EB | EB | EB |
| 820 pF | 821 | | | | F | G | J | K | M | BB | BB | BB | BB | BB | CF | CF | CF | CF | CF | CF | DN | DN | DN | DN | DN | DN | EB | EB | EB | EB | EB | EB |
| 910 pF | 911 | | | | F | G | J | K | M | BB | BB | BB | BB | BB | CF | CF | CF | CF | CF | CF | DN | DN | DN | DN | DP | DP | EB | EB | EB | EB | EB | EB |
| 1,000 pF | 102 | | | | F | G | J | K | M | BB | BB | BB | BB | BB | CF | CF | CF | CF | CF | CF | DN | DN | DN | DN | DP | DP | EB | EB | EB | EB | EB | EE |
| 1,100 pF | 112 | | | | F | G | J | K | M | BB | BB | BB | BB | BB | CF | CF | CF | CF | CF | CF | DN | DN | DN | DN | DN | DN | EB | EB | EB | EB | EB | EB |
| 1,200 pF | 122 | | | | F | G | J | K | M | BB | BB | BB | BB | BB | CF | CF | CF | CF | CF | CF | DN | DN | DN | DN | DN | DN | EB | EB | EB | EB | EB | EB |
| 1,300 pF | 132 | | | | F | G | J | K | M | BB | BB | BB | BB | BB | CF | CF | CF | CF | CF | CF | DP | DP | DP | DP | DP | DP | EB | EB | EB | EB | EC | EC |
| 1,500 pF | 152 | | | | F | G | J | K | M | BB | BB | BB | BB | BB | CF | CF | CF | CF | CF | CF | DP | DP | DP | DP | DP | DP | EB | EB | EB | EB | ED | ED |
| 1,600 pF | 162 | | | | F | G | J | K | M | | | | | | CF | CF | CF | CF | CF | CF | DP | DP | DP | DP | DP | DP | EB | EB | EB | EB | ED | ED |
| 1,800 pF | 182 | | | | F | G | J | K | M | | | | | | CF | CF | CF | CF | CF | CF | DP | DP | DP | DP | DP | DP | EB | EB | EB | EB | ED | ED |
| 2,000 pF | 202 | | | | F | G | J | K | M | | | | | | CF | CF | CF | CF | CF | CF | DN | DN | DN | DN | DN | DN | EB | EB | EB | EB | ED | ED |
| 2,200 pF | 222 | | | | F | G | J | K | M | | | | | | CF | CF | CF | CF | CF | CF | DN | DN | DN | DN | DN | DN | EB | EB | EB | EB | EE | EE |
| 2,400 pF | 242 | | | | F | G | J | K | M | | | | | | CF | CF | CF | CF | CF | CF | DN | DN | DN | DN | DN | DN | EB | EB | EB | EB | EC | EC |
| 2,700 pF | 272 | | | | F | G | J | K | M | | | | | | CF | CF | CF | CF | CF | CF | DN | DN | DN | DN | DN | DN | EB | EB | EB | EB | EC | EC |
| 3,000 pF | 302 | | | | F | G | J | K | M | | | | | | CF | CF | CF | CF | CF | CF | DP | DP | DP | DP | DN | DN | EC | EC | EC | EC | EC | EC |
| 3,300 pF | 332 | | | | F | G | J | K | M | | | | | | CF | CF | CF | CF | CF | CF | DP | DP | DP | DP | DN | DN | EC | EC | EC | EC | EE | EE |
| 3,600 pF | 362 | | | | F | G | J | K | M | | | | | | CF | CF | CF | CF | CF | CF | DP | DP | DP | DP | DN | DN | EC | EC | EC | EC | EE | EE |
| 3,900 pF | 392 | | | | F | G | J | K | M | | | | | | CF | CF | CF | CF | CF | CF | DE | DE | DE | DE | DN | DN | EC | EC | EC | EC | EF | EF |
| 4,300 pF | 432 | | | | F | G | J | K | M | | | | | | CF | CF | CF | CF | CF | CF | DE | DE | DE | DE | DN | DN | EC | EC | EC | EC | EC | EC |
| 4,700 pF | 472 | | | | F | G | J | K | M | | | | | | CF | CF | CF | CF | CF | CF | DE | DE | DE | DE | DN | DN | EC | EC | EC | EC | EC | EC |
| 5,100 pF | 512 | | | | F | G | J | K | M | | | | | | CF | CF | CF | CF | CF | CF | DE | DE | DE | DE | DN | DN | ED | ED | ED | ED | ED | ED |
| 5,600 pF | 562 | | | | F | G | J | K | M | | | | | | CF | CF | CF | CF | CF | CF | DN | DN | DN | DN | DN | DN | ED | ED | ED | ED | ED | ED |
| 6,200 pF | 622 | | | | F | G | J | K | M | | | | | | CF | CF | CF | CF | CF | CF | DN | DN | DN | DN | DN | DN | EB | EB | EB | EB | EB | EB |
| 6,800 pF | 682 | | | | F | G | J | K | M | | | | | | CF | CF | CF | CF | CF | CF | DN | DN | DN | DN | DN | DN | EB | EB | EB | EB | EB | EB |
| 7,500 pF | 752 | | | | F | G | J | K | M | | | | | | CF | CF | CF | CF | CF | CF | DN | DN | DN | DN | DN | DN | EB | EB | EB | EB | EB | EB |
| 8,200 pF | 822 | | | | F | G | J | K | M | | | | | | CF | CF | CF | CF | CF | CF | DN | DN | DN | DN | DN | DN | EC | EC | EC | EC | EB | EB |
| 9,100 pF | 912 | | | | F | G | J | K | M | | | | | | CF | CF | CF | CF | CF | CF | DN | DN | DN | DN | DN | DN | EC | EC | EC | EC | EB | EB |
| 10,000 pF | 103 | | | | F | G | J | K | M | | | | | | CF | CF | CF | CF | CF | CF | DN | DN | DN | DN | DP | DP | ED | ED | ED | ED | EB | EB |
| 12,000 pF | 123 | | | | F | G | J | K | M | | | | | | CF | CF | CF | CF | CF | CF | DN | DN | DN | DN | DN | DN | EB | EB | EB | EB | EB | EB |
| 15,000 pF | 153 | | | | F | G | J | K | M | | | | | | CF | CF | CF | CF | CF | CF | DN | DN | DN | DN | DP | DP | EB | EB | EB | EB | EB | EB |
| 18,000 pF | 183 | | | | F | G | J | K | M | | | | | | CF | CF | CF | CF | CF | CF | DN | DN | DN | DP | DP | DP | EB | EB | EB | EB | EB | EB |
| 22,000 pF | 223 | | | | F | G | J | K | M | | | | | | CF | CF | CF | CF | CF | CF | DP | DP | DP | DF | DF | DF | EB | EB | EB | EB | EC | EC |
| 27,000 pF | 273 | | | | F | G | J | K | M | | | | | | CF | CF | CF | CF | CF | CF | DF | DF | DF | DF | DF | DF | EB | EB | EB | EB | EE | EE |
| 33,000 pF | 333 | | | | F | G | J | K | M | | | | | | CF | CF | CF | CF | CF | CF | DG | DG | DG | DG | DG | DG | EB | EB | EB | EB | EE | EE |
| 39,000 pF | 393 | | | | F | G | J | K | M | | | | | | CF | CF | CF | CF | CF | CF | DG | DG | DG | DG | DG | DG | EC | EC | EC | EE | EH | EH |
| 47,000 pF | 473 | | | | F | G | J | K | M | | | | | | CF | CF | CF | CF | CF | CF | DG | DG | DG | DG | DG | DG | EC | EC | EC | EE | EH | EH |
| 56,000 pF | 563 | | | | F | G | J | K | M | | | | | | CF | CF | CF | CF | CF | CF | | | | | | | ED | ED | ED | EF | EH | EH |
| 68,000 pF | 683 | | | | F | G | J | K | M | | | | | | CF | CF | CF | CF | CF | CF | | | | | | | EF | EF | EF | EH | EH | EH |
| 82,000 pF | 823 | | | | F | G | J | K | M | | | | | | CF | CF | CF | CF | CF | CF | | | | | | | EH | EH | EH | EH | EH | EH |
| 0.10 μF | 104 | | | | F | G | J | K | M | | | | | | CF | CF | CF | CF | CF | CF | | | | | | | EH | EH | EH | EH | EH | EH |
| Capacitance | Cap Code | Rated Voltage (VDC) | | | 10 | 16 | 25 | 50 | 100 | 10 | 16 | 25 | 50 | 100 | 200 | 10 | 16 | 25 | 50 | 100 | 200 | 10 | 16 | 25 | 50 | 100 | 200 | | | | | |
| | | Voltage Code | | | 8 | 4 | 3 | 5 | 1 | 8 | 4 | 3 | 5 | 1 | 2 | 8 | 4 | 3 | 5 | 1 | 2 | 8 | 4 | 3 | 5 | 1 | 2 | | | | | |
| | | Case Size / Series | | | C0402H | | | | | C0603H | | | | | | C0805H | | | | | | C1206H | | | | | | | | | | |

*Capacitance range Includes E24 decade values only. (i.e., 10, 11, 12, 13, 15, 16, 18, 20, 22, 24, 27, 30, 33, 36, 39, 43, 47, 51, 56, 62, 68, 75, 82, and 91)
 KEMET reserves the right to substitute product with an improved temperature characteristic, tighter capacitance tolerance and/or higher voltage capability within the same form factor (configuration and dimensions).

These products are protected under US Patents 7,172,985 and 7,670,981, other patents pending, and any foreign counterparts.

Table 2A – Chip Thickness/Tape & Reel Packaging Quantities

| Thickness Code | Case Size ¹ | Thickness ± Range (mm) | Paper Quantity | | Plastic Quantity | |
|----------------|------------------------|------------------------|-----------------------------|----------|------------------|----------|
| | | | 7" Reel | 13" Reel | 7" Reel | 13" Reel |
| BB | 0402 | 0.50±0.05 | 10,000 | 50,000 | 0 | 0 |
| CF | 0603 | 0.80±0.07 | 4,000 | 15,000 | 0 | 0 |
| DN | 0805 | 0.78±0.10 | 4,000 | 15,000 | 0 | 0 |
| DP | 0805 | 0.90±0.10 | 4,000 | 15,000 | 0 | 0 |
| DE | 0805 | 1.00±0.10 | 0 | 0 | 2,500 | 10,000 |
| DF | 0805 | 1.10±0.10 | 0 | 0 | 2,500 | 10,000 |
| DG | 0805 | 1.25±0.15 | 0 | 0 | 2,500 | 10,000 |
| EB | 1206 | 0.78±0.10 | 4,000 | 10,000 | 4,000 | 10,000 |
| EC | 1206 | 0.90±0.10 | 0 | 0 | 4,000 | 10,000 |
| ED | 1206 | 1.00±0.10 | 0 | 0 | 2,500 | 10,000 |
| EE | 1206 | 1.10±0.10 | 0 | 0 | 2,500 | 10,000 |
| EF | 1206 | 1.20±0.15 | 0 | 0 | 2,500 | 10,000 |
| EH | 1206 | 1.60±0.20 | 0 | 0 | 2,000 | 8,000 |
| FB | 1210 | 0.78±0.10 | 0 | 0 | 4,000 | 10,000 |
| FC | 1210 | 0.90±0.10 | 0 | 0 | 4,000 | 10,000 |
| FE | 1210 | 1.00±0.10 | 0 | 0 | 2,500 | 10,000 |
| FF | 1210 | 1.10±0.10 | 0 | 0 | 2,500 | 10,000 |
| FG | 1210 | 1.25±0.15 | 0 | 0 | 2,500 | 10,000 |
| FH | 1210 | 1.55±0.15 | 0 | 0 | 2,000 | 8,000 |
| FM | 1210 | 1.70±0.20 | 0 | 0 | 2,000 | 8,000 |
| GB | 1812 | 1.00±0.10 | 0 | 0 | 1,000 | 4,000 |
| GD | 1812 | 1.25±0.15 | 0 | 0 | 1,000 | 4,000 |
| GH | 1812 | 1.40±0.15 | 0 | 0 | 1,000 | 4,000 |
| GK | 1812 | 1.60±0.20 | 0 | 0 | 1,000 | 4,000 |
| GN | 1812 | 1.70±0.20 | 0 | 0 | 1,000 | 4,000 |
| JJ | 2220 | 2.20±0.15 | 0 | 0 | 500 | 2,000 |
| Thickness Code | Case Size ¹ | Thickness ± Range (mm) | 7" Reel | 13" Reel | 7" Reel | 13" Reel |
| | | | Paper Quantity ¹ | | Plastic Quantity | |

Package quantity based on finished chip thickness specifications.

Table 2B – Bulk Packaging Quantities

| Packaging Type | | Loose Packaging | | Secure Packaging | | |
|-------------------------------|-------------|------------------------|--|---|---------|---------|
| | | Bulk Bag (default) | | 2" x 2" Waffle Pack/ Tray ³ | | |
| Packaging C-Spec ¹ | | N/A ² | | 7282/7292 | | |
| Case Size | | Chip Thickness (mm) | Packaging Quantities (pieces/unit packaging) | | | |
| EIA (in) | Metric (mm) | | Minimum | Maximum | Minimum | Maximum |
| 0402 | 1005 | All | 1 | 50,000 | 1 | 368 |
| 0603 | 1608 | | | | | 368 |
| 0805 | 2012 | | | | | 100 |
| 1206 | 3216 | ≤ 1.25 (nominal) | | 126 | | |
| 1206 | 3216 | > 1.25 (nominal) | | 50 | | |
| 1210 | 3225 | All | | 20,000 | | 1 |
| 1808 | 4520 | | 50 | | | |
| 1812 | 4532 | | 42 | | | |
| 1825 | 4564 | | 20 | | | |
| 2220 | 5650 | | 20 | | | |
| 2225 | 5664 | | 20 | | | |

¹ The "Packaging C-Spec" is a 4-digit code which identifies the packaging type. When ordering, the proper code must be included in the 15th through 18th character positions of the ordering code. See "Ordering Information" section of this document for further details. Product ordered without a packaging C-Spec will default to our standard "Bulk Bag" packaging.

² A packaging C-Spec (see note 1 above) is not required For "Bulk Bag" packaging (excluding Anti-Static Bulk Bag). The 15th through 18th character positions of the ordering code should be left blank. All product ordered without a packaging C-Spec will default to our standard "Bulk Bag" packaging.

³ Also commonly referred to as "Chip Carrier" or "Molded Tray". All tray packaging options offer static protection.

Table 3 – Chip Capacitor Land Pattern Design Recommendations per IPC–7351

| EIA Size Code | Metric Size Code | Density Level A: Maximum (Most) Land Protrusion (mm) | | | | | Density Level B: Median (Nominal) Land Protrusion (mm) | | | | | Density Level C: Minimum (Least) Land Protrusion (mm) | | | | |
|-------------------|------------------|--|------|------|------|------|--|------|------|------|------|---|------|------|------|------|
| | | C | Y | X | V1 | V2 | C | Y | X | V1 | V2 | C | Y | X | V1 | V2 |
| 0402 | 1005 | 0.50 | 0.72 | 0.72 | 2.20 | 1.20 | 0.45 | 0.62 | 0.62 | 1.90 | 1.00 | 0.40 | 0.52 | 0.52 | 1.60 | 0.80 |
| 0603 | 1608 | 0.90 | 1.15 | 1.10 | 4.00 | 2.10 | 0.80 | 0.95 | 1.00 | 3.10 | 1.50 | 0.60 | 0.75 | 0.90 | 2.40 | 1.20 |
| 0805 | 2012 | 1.00 | 1.35 | 1.55 | 4.40 | 2.60 | 0.90 | 1.15 | 1.45 | 3.50 | 2.00 | 0.75 | 0.95 | 1.35 | 2.80 | 1.70 |
| 1206 | 3216 | 1.60 | 1.35 | 1.90 | 5.60 | 2.90 | 1.50 | 1.15 | 1.80 | 4.70 | 2.30 | 1.40 | 0.95 | 1.70 | 4.00 | 2.00 |
| 1210 | 3225 | 1.60 | 1.35 | 2.80 | 5.65 | 3.80 | 1.50 | 1.15 | 2.70 | 4.70 | 3.20 | 1.40 | 0.95 | 2.60 | 4.00 | 2.90 |
| 1210 ¹ | 3225 | 1.50 | 1.60 | 2.90 | 5.60 | 3.90 | 1.40 | 1.40 | 2.80 | 4.70 | 3.30 | 1.30 | 1.20 | 2.70 | 4.00 | 3.00 |
| 1812 | 4532 | 2.15 | 1.60 | 3.60 | 6.90 | 4.60 | 2.05 | 1.40 | 3.50 | 6.00 | 4.00 | 1.95 | 1.20 | 3.40 | 5.30 | 3.70 |
| 2220 | 5650 | 2.75 | 1.70 | 5.50 | 8.20 | 6.50 | 2.65 | 1.50 | 5.40 | 7.30 | 5.90 | 2.55 | 1.30 | 5.30 | 6.60 | 5.60 |

¹ Only for capacitance values $\geq 22 \mu F$

Density Level A: For low-density product applications. Recommended for wave solder applications and provides a wider process window for reflow solder processes. KEMET only recommends wave soldering of EIA 0603, 0805 and 1206 case sizes.

Density Level B: For products with a moderate level of component density. Provides a robust solder attachment condition for reflow solder processes.

Density Level C: For high component density product applications. Before adapting the minimum land pattern variations the user should perform qualification testing based on the conditions outlined in IPC Standard 7351 (IPC-7351).

Image below based on Density Level B for an EIA 1210 case size.

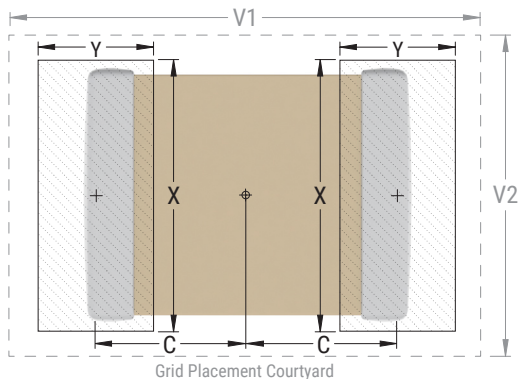

Soldering Process

Recommended Soldering Technique:

- Solder wave or solder reflow for EIA case sizes 0603, 0805 and 1206
- All other EIA case sizes are limited to solder reflow only

Recommended Reflow Soldering Profile:

KEMET’s families of surface mount multilayer ceramic capacitors (SMD MLCCs) are compatible with wave (single or dual), convection, IR or vapor phase reflow techniques. Preheating of these components is recommended to avoid extreme thermal stress. KEMET’s recommended profile conditions for convection and IR reflow reflect the profile conditions of the IPC/J-STD-020 standard for moisture sensitivity testing. These devices can safely withstand a maximum of three reflow passes at these conditions.

| Profile Feature | Termination Finish | |
|---|--------------------|--------------------|
| | SnPb | 100% Matte Sn |
| Preheat/Soak | | |
| Temperature Minimum (T_{Smin}) | 100°C | 150°C |
| Temperature Maximum (T_{Smax}) | 150°C | 200°C |
| Time (t_s) from T_{Smin} to T_{Smax} | 60 – 120 seconds | 60 – 120 seconds |
| Ramp-Up Rate (T_L to T_p) | 3°C/second maximum | 3°C/second maximum |
| Liquidous Temperature (T_L) | 183°C | 217°C |
| Time Above Liquidous (t_L) | 60 – 150 seconds | 60 – 150 seconds |
| Peak Temperature (T_p) | 235°C | 260°C |
| Time Within 5°C of Maximum Peak Temperature (t_p) | 20 seconds maximum | 30 seconds maximum |
| Ramp-Down Rate (T_p to T_L) | 6°C/second maximum | 6°C/second maximum |
| Time 25°C to Peak Temperature | 6 minutes maximum | 8 minutes maximum |

Note 1: All temperatures refer to the center of the package, measured on the capacitor body surface that is facing up during assembly reflow.

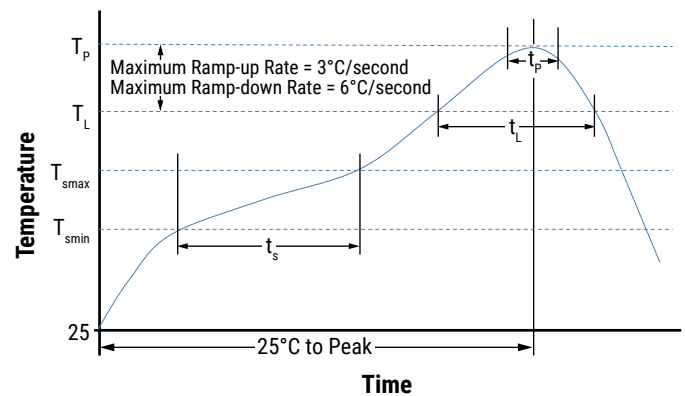

Table 4 – Performance & Reliability: Test Methods and Conditions

| Product Qualification Test Plan | |
|---|---|
| Reliability/Environmental Tests per MIL-STD-202//JESD22 | |
| High Temperature Life | 200°C rated voltage 1,000 hours |
| Load Humidity | 85°C/85%RH rated voltage 1,000 hours |
| Low Voltage Humidity | 85°C/85%RH, 1.5 V, 1,000 hours |
| Temperature Cycling | -55°C to +200°C, 50 Cycles |
| Thermal Shock | -55°C to +150°C, 20 seconds transfer, 15 minute dwell, 300 cycles |
| Moisture Resistance | Cycled Temp/RH 0 V, 10 cycles at 24 hours each |
| Physical, Mechanical & Process Tests per MIL-STD 202/JIS-C-6429 | |
| Resistance to Solvents | Include Aqueous wash chemical, OKEM Clean or equivalent |
| Mechanical Shock and Vibration | Method 213: Figure 1, Condition F Method 204: 5 gs for 20 minutes 12 cycles |
| Resistance to Soldering Heat | Condition B, no per-heat of samples, Single Wave Solder |
| Terminal Strength | Force of 1.8 kg for 60 seconds |
| Board Flex | Appendix 2, Note: 3.0 mm (minimum) |

Storage and Handling

Ceramic chip capacitors should be stored in normal working environments. While the chips themselves are quite robust in other environments, solderability will be degraded by exposure to high temperatures, high humidity, corrosive atmospheres, and long term storage. In addition, packaging materials will be degraded by high temperature—reels may soften or warp and tape peel force may increase. KEMET recommends that maximum storage temperature not exceed 40°C and maximum storage humidity not exceed 70% relative humidity. In addition, temperature fluctuations should be minimized to avoid condensation on the parts and atmospheres should be free of chlorine and sulfur bearing compounds. For optimized solderability chip stock should be used promptly, preferably within the time frame outlined in the table below:

| Termination Finish | Termination Finish Ordering Code ¹ | Storage Life |
|--|---|------------------------------------|
| 100% Matte Tin (Sn) | C | 1.5 years upon receipt |
| SnPb (5% Pb min.) | L | 1.5 years upon receipt |
| Gold (Au) 1.97 – 11.8 µin ² | E | 6 months upon receipt ² |
| Gold (Au) 30 – 70 µin | F | 1.5 years upon receipt |
| Gold (Au) 100 µin min. | G | 1.5 years upon receipt |

¹ The fourteenth (14th) character position of the KEMET part number is assigned to identify and/or define the termination finish. For more information, see “Ordering Information” section of this document.

² Gold plating option “E” devices should remain in its factory sealed moisture sensitive packaging during storage. If the factory sealed packaging is disturbed please store any remaining packaged components in a dry box container to prevent oxidation of the termination finish.

Construction

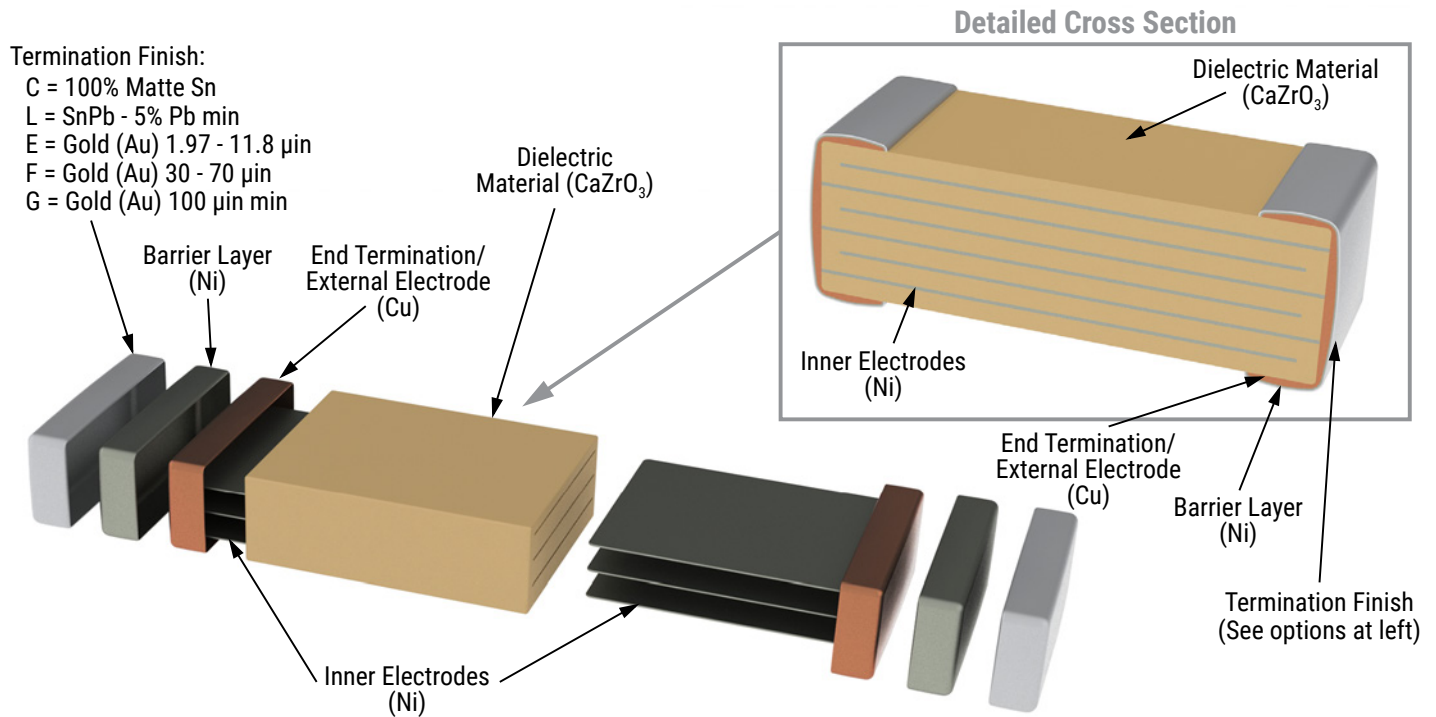

Capacitor Marking (Optional):

Laser marking option is not available on:

- COG, Ultra Stable X8R and Y5V dielectric devices
- EIA 0402 case size devices
- EIA 0603 case size devices with Flexible Termination option.
- KPS Commercial and Automotive grade stacked devices.

These capacitors are supplied unmarked only.

Tape & Reel Packaging Information

KEMET offers multilayer ceramic chip capacitors packaged in 8, 12 and 16 mm tape on 7" and 13" reels in accordance with EIA Standard 481. This packaging system is compatible with all tape-fed automatic pick and place systems. See Table 2 for details on reeling quantities for commercial chips.

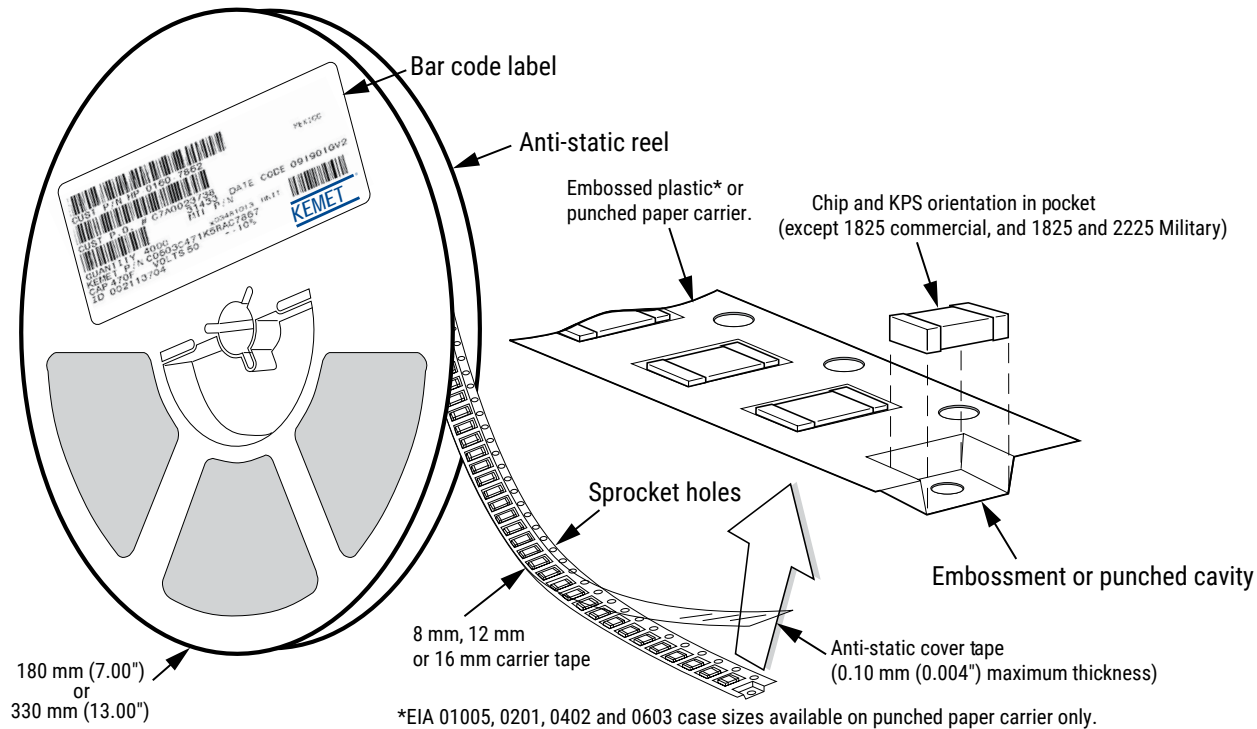

Table 5 – Carrier Tape Configuration, Embossed Plastic & Punched Paper (mm)

| EIA Case Size | Tape Size (W)* | Embossed Plastic | | Punched Paper | |
|-------------------|----------------|--------------------------|----------|--------------------------|----------|
| | | 7" Reel | 13" Reel | 7" Reel | 13" Reel |
| | | Pitch (P ₁)* | | Pitch (P ₁)* | |
| 01005 – 0402 | 8 | | | 2 | 2 |
| 0603 | 8 | | | 4 | 4 |
| 0805 | 8 | 4 | 4 | 4 | 4 |
| 1206 – 1210 | 8 | 4 | 4 | 4 | 4 |
| 1805 – 1808 | 12 | 4 | 4 | | |
| ≥ 1812 | 12 | 8 | 8 | | |
| KPS 1210 | 12 | 8 | 8 | | |
| KPS 1812 & 2220 | 16 | 12 | 12 | | |
| Array 0508 & 0612 | 8 | 4 | 4 | | |

*Refer to Figures 1 & 2 for W and P₁ carrier tape reference locations.

*Refer to Tables 6 & 7 for tolerance specifications.

Figure 1 – Embossed (Plastic) Carrier Tape Dimensions



Table 6 – Embossed (Plastic) Carrier Tape Dimensions

Metric will govern

| Constant Dimensions – Millimeters (Inches) | | | | | | | | | |
|--|-------------------------------------|----------------------------------|----------------------------|---------------------------|----------------------------|---------------------------|----------------------------------|--|---------------------------|
| Tape Size | D ₀ | D ₁ Minimum Note 1 | E ₁ | P ₀ | P ₂ | R Reference Note 2 | S ₁ Minimum Note 3 | T Maximum | T ₁ Maximum |
| 8 mm | 1.5+0.10 -0.0 (0.059+0.004 -0.0) | 1.0 (0.039) | 1.75±0.10 (0.069±0.004) | 4.0±0.10 (0.157±0.004) | 2.0±0.05 (0.079±0.002) | 25.0 (0.984) | 0.600 (0.024) | 0.600 (0.024) | 0.100 (0.004) |
| 12 mm | | 1.5 (0.059) | | | | | | | |
| 16 mm | | | | | | | | | |
| Variable Dimensions – Millimeters (Inches) | | | | | | | | | |
| Tape Size | Pitch | B ₁ Maximum Note 4 | E ₂ Minimum | F | P ₁ | T ₂ Maximum | W Maximum | A ₀ , B ₀ & K ₀ | |
| 8 mm | Single (4 mm) | 4.35 (0.171) | 6.25 (0.246) | 3.5±0.05 (0.138±0.002) | 4.0±0.10 (0.157±0.004) | 2.5 (0.098) | 8.3 (0.327) | Note 5 | |
| 12 mm | Single (4 mm) & Double (8 mm) | 8.2 (0.323) | 10.25 (0.404) | 5.5±0.05 (0.217±0.002) | 8.0±0.10 (0.315±0.004) | 4.6 (0.181) | 12.3 (0.484) | | |
| 16 mm | Triple (12 mm) | 12.1 (0.476) | 14.25 (0.561) | 7.5±0.05 (0.138±0.002) | 12.0±0.10 (0.157±0.004) | 4.6 (0.181) | 16.3 (0.642) | | |

- The embossment hole location shall be measured from the sprocket hole controlling the location of the embossment. Dimensions of embossment location and hole location shall be applied independent of each other.
- The tape with or without components shall pass around R without damage (see Figure 6).
- If S₁ < 1.0 mm, there may not be enough area for cover tape to be properly applied (see EIA Standard 481 paragraph 4.3 section b).
- B₁ dimension is a reference dimension for tape feeder clearance only.
- The cavity defined by A₀, B₀ and K₀ shall surround the component with sufficient clearance that:
 - the component does not protrude above the top surface of the carrier tape.
 - the component can be removed from the cavity in a vertical direction without mechanical restriction, after the top cover tape has been removed.
 - rotation of the component is limited to 20° maximum for 8 and 12 mm tapes and 10° maximum for 16 mm tapes (see Figure 3).
 - lateral movement of the component is restricted to 0.5 mm maximum for 8 and 12 mm wide tape and to 1.0 mm maximum for 16 mm tape (See Figure 4).
 - for KPS Series product, A₀ and B₀ are measured on a plane 0.3 mm above the bottom of the pocket.
 - see Addendum in EIA Standard 481 for standards relating to more precise taping requirements.

Figure 2 – Punched (Paper) Carrier Tape Dimensions

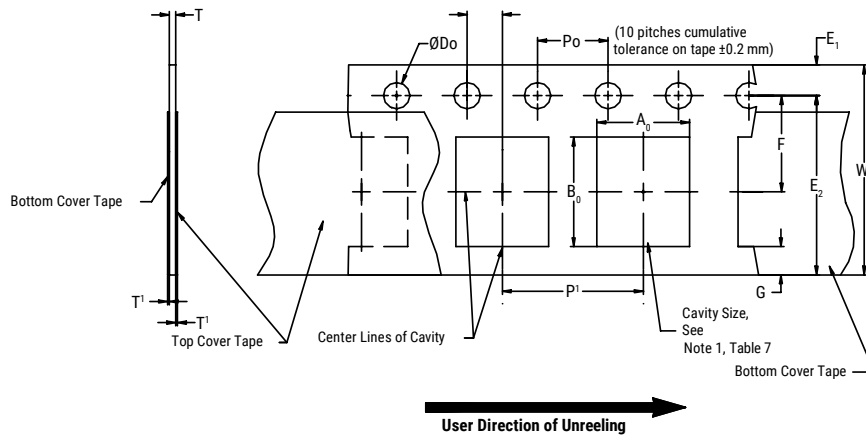

Table 7 – Punched (Paper) Carrier Tape Dimensions

Metric will govern

| Constant Dimensions – Millimeters (Inches) | | | | | | | |
|--|---|-----------------------------------|----------------------------------|----------------------------------|----------------------------|-----------------|--------------------|
| Tape Size | D_0 | E_1 | P_0 | P_2 | T_1 Maximum | G Minimum | R Reference Note 2 |
| 8 mm | $1.5 +0.10 -0.0$ (0.059 +0.004 -0.0) | 1.75 ± 0.10 (0.069 ±0.004) | 4.0 ± 0.10 (0.157 ±0.004) | 2.0 ± 0.05 (0.079 ±0.002) | 0.10 (0.004) Maximum | 0.75 (0.030) | 25 (0.984) |
| Variable Dimensions – Millimeters (Inches) | | | | | | | |
| Tape Size | Pitch | E2 Minimum | F | P_1 | T Maximum | W Maximum | $A_0 B_0$ |
| 8 mm | Half (2 mm) | 6.25 (0.246) | 3.5 ± 0.05 (0.138 ±0.002) | 2.0 ± 0.05 (0.079 ±0.002) | 1.1 (0.098) | 8.3 (0.327) | Note 1 |
| 8 mm | Single (4 mm) | | | 4.0 ± 0.10 (0.157 ±0.004) | | | |

- The cavity defined by A_0 , B_0 and T shall surround the component with sufficient clearance that:
 - the component does not protrude beyond either surface of the carrier tape.
 - the component can be removed from the cavity in a vertical direction without mechanical restriction, after the top cover tape has been removed.
 - rotation of the component is limited to 20° maximum (see Figure 3).
 - lateral movement of the component is restricted to 0.5 mm maximum (see Figure 4).
 - see Addendum in EIA Standard 481 for standards relating to more precise taping requirements.
- The tape with or without components shall pass around R without damage (see Figure 6).

Packaging Information Performance Notes

- Cover Tape Break Force:** 1.0 Kg minimum.
- Cover Tape Peel Strength:** The total peel strength of the cover tape from the carrier tape shall be:

| Tape Width | Peel Strength |
|--------------|----------------------------------|
| 8 mm | 0.1 to 1.0 Newton (10 to 100 gf) |
| 12 and 16 mm | 0.1 to 1.3 Newton (10 to 130 gf) |

The direction of the pull shall be opposite the direction of the carrier tape travel. The pull angle of the carrier tape shall be 165° to 180° from the plane of the carrier tape. During peeling, the carrier and/or cover tape shall be pulled at a velocity of 300 ±10 mm/minute.

- Labeling:** Bar code labeling (standard or custom) shall be on the side of the reel opposite the sprocket holes. Refer to EIA Standards 556 and 624.

Figure 3 – Maximum Component Rotation

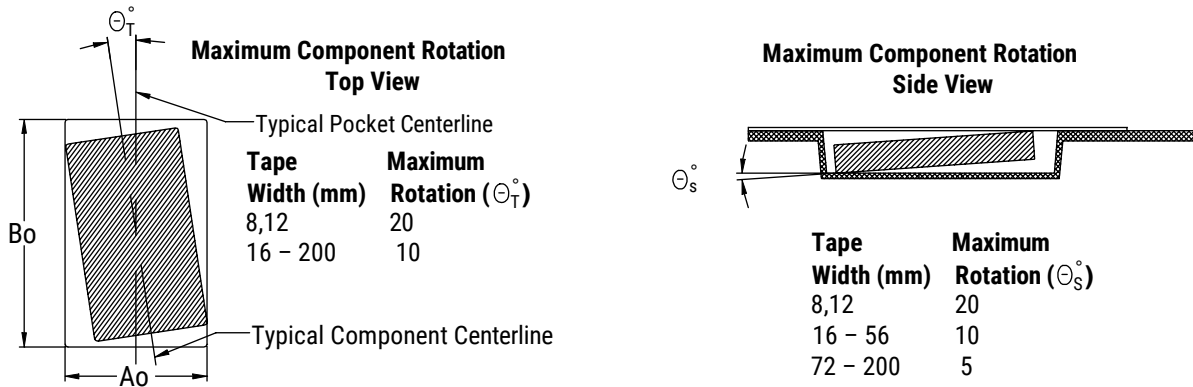

Figure 4 – Maximum Lateral Movement

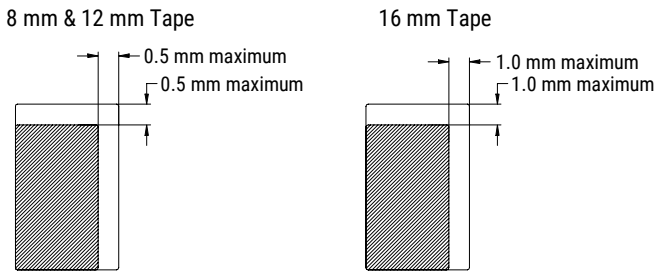

Figure 5 – Bending Radius

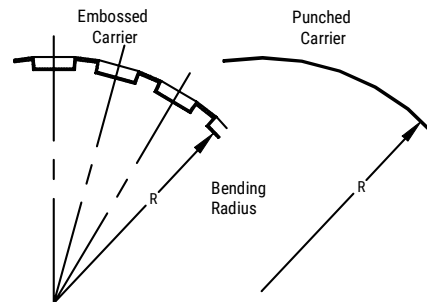

Figure 6 – Reel Dimensions



Note: Drive spokes optional; if used, dimensions B and D shall apply.

Table 8 – Reel Dimensions

Metric will govern

| Constant Dimensions – Millimeters (Inches) | | | | |
|--|---|---------------------------------------|--|---|
| Tape Size | A | B Minimum | C | D Minimum |
| 8 mm | 178 ±0.20 (7.008 ±0.008) or 330 ±0.20 (13.000 ±0.008) | 1.5 (0.059) | 13.0 +0.5/-0.2 (0.521 +0.02/-0.008) | 20.2 (0.795) |
| 12 mm | | | | |
| 16 mm | | | | |
| Variable Dimensions – Millimeters (Inches) | | | | |
| Tape Size | N Minimum | W ₁ | W ₂ Maximum | W ₃ |
| 8 mm | 50 (1.969) | 8.4 +1.5/-0.0 (0.331 +0.059/-0.0) | 14.4 (0.567) | Shall accommodate tape width without interference |
| 12 mm | | 12.4 +2.0/-0.0 (0.488 +0.078/-0.0) | 18.4 (0.724) | |
| 16 mm | | 16.4 +2.0/-0.0 (0.646 +0.078/-0.0) | 22.4 (0.882) | |

Figure 7 – Tape Leader & Trailer Dimensions



Figure 8 – Maximum Camber

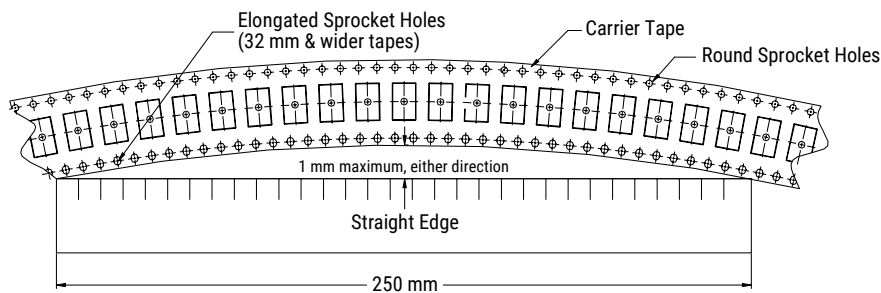

Waffle Tray Packaging Information – 2" x 2" w/ Static Protection

Figure 9 – Waffle Tray Dimensions – Inches (Millimeters)

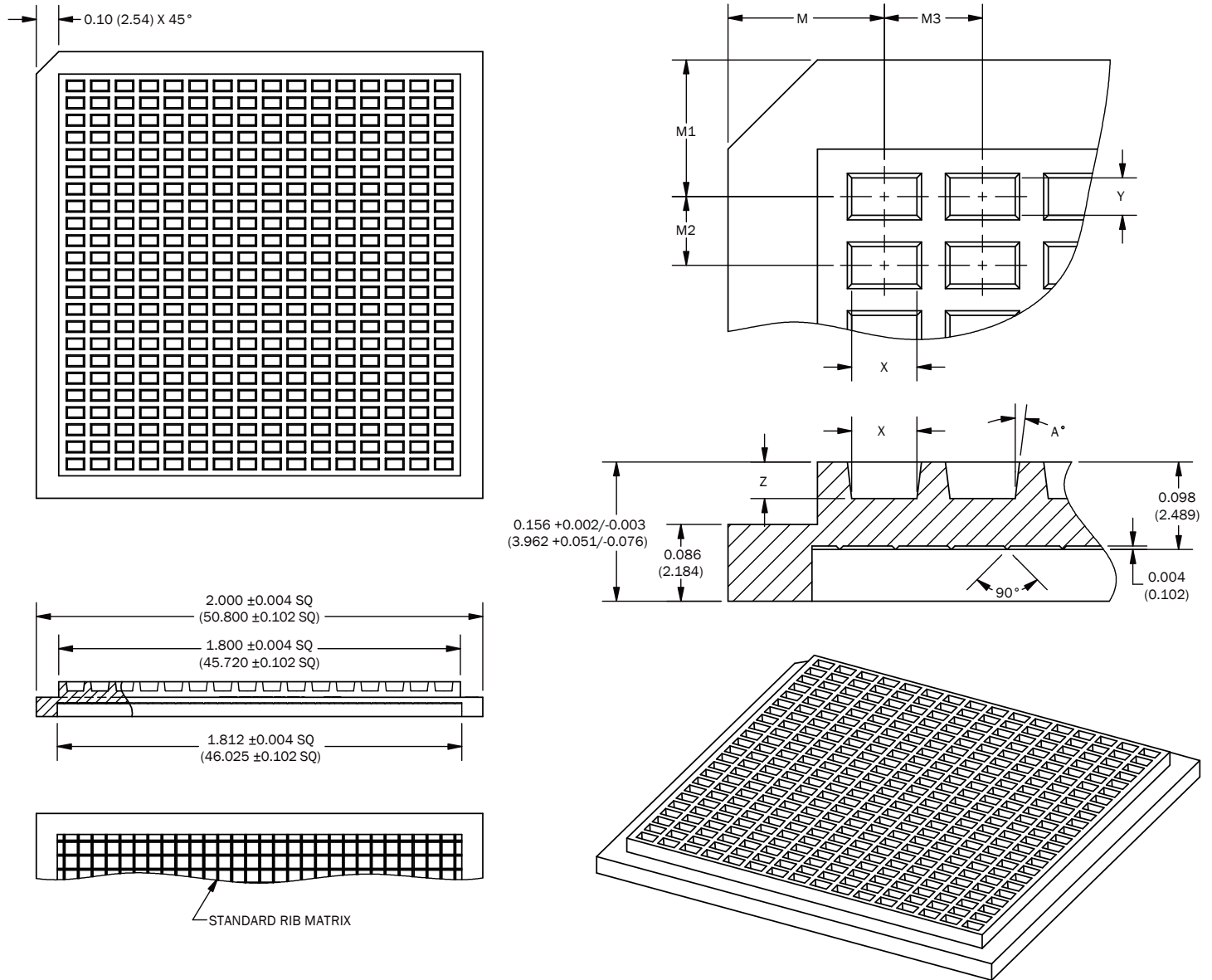

Table 9A – Waffle Tray Dimensions – Inches

| Case Size | | 2" x 2" Waffle Tray Dimensions – Inches | | | | | | | | | Packaging Quantity (pcs/unit packaging) |
|---------------------|-------------|---|--------|--------|--------|--------|--------|--------|--------|---------|---|
| | | M | M1 | M2 | M3 | X | Y | Z | A° | MATRIX | |
| EIA (in) | Metric (mm) | ±0.003 | ±0.003 | ±0.002 | ±0.002 | ±0.002 | ±0.002 | ±0.003 | ± 1/2° | (X x Y) | |
| 0402 | 1005 | 0.175 | 0.153 | 0.077 | 0.110 | 0.073 | 0.042 | 0.041 | 7 | 16 X 23 | 368 |
| 0504 | 1210 | 0.235 | 0.226 | 0.172 | 0.170 | 0.080 | 0.090 | 0.055 | 5 | 10 X 10 | 100 |
| 0603 | 1608 | 0.175 | 0.153 | 0.077 | 0.110 | 0.073 | 0.042 | 0.041 | 7 | 16 X 23 | 368 |
| 0805 | 2012 | 0.232 | 0.186 | 0.181 | 0.171 | 0.062 | 0.092 | 0.036 | 10 | 10 X 10 | 100 |
| 1005 | 2512 | 0.230 | 0.240 | 0.190 | 0.140 | 0.060 | 0.110 | 0.075 | 5 | 12 X 9 | 108 |
| 1206 ^{1,2} | 3216 | 0.194 | 0.228 | 0.193 | 0.124 | 0.067 | 0.130 | 0.065 | 5 | 14 X 9 | 126 |
| 1206 ^{1,3} | 3216 | 0.250 | 0.250 | 0.375 | 0.167 | 0.100 | 0.200 | 0.070 | 5 | 10 X 5 | 50 |
| 1210 | 3225 | 0.217 | 0.244 | 0.215 | 0.174 | 0.110 | 0.145 | 0.080 | 5 | 10 X 8 | 80 |
| 1808 | 4520 | 0.271 | 0.285 | 0.286 | 0.243 | 0.150 | 0.200 | 0.075 | 5 | 7 X 6 | 42 |
| 1812 | 4532 | 0.271 | 0.285 | 0.286 | 0.243 | 0.150 | 0.200 | 0.075 | 5 | 7 X 6 | 42 |
| 1825 | 4564 | 0.318 | 0.362 | 0.424 | 0.34 | 0.24 | 0.32 | 0.032 | 5 | 5 X 4 | 20 |
| 2220 | 5650 | 0.318 | 0.362 | 0.424 | 0.34 | 0.24 | 0.32 | 0.032 | 5 | 5 X 4 | 20 |
| 2225 | 5664 | 0.318 | 0.362 | 0.424 | 0.34 | 0.24 | 0.32 | 0.032 | 5 | 5 X 4 | 20 |

¹ Packaging of 1206 (3216 metric) case size capacitors is dependent upon the nominal chip thickness of the device. See "Capacitance Range/Selection Waterfall" and "Chip Thickness/Tape & Reel Packaging Quantities" to identify the nominal chip thickness of the capacitor.

² Assigned to 1206 (3216 metric) case size capacitors with nominal thickness of ≤ 1.25mm (0.049 inches).

³ Assigned to 1206 (3216 metric) case size capacitors with nominal thickness of > 1.25mm (0.049 inches).

Table 9B – Waffle Tray Dimensions – Millimeters

| Case Size | | 2" x 2" Waffle Tray Dimensions – Millimeters | | | | | | | | | Packaging Quantity (pcs/unit packaging) |
|---------------------|-------------|--|-------|-------|-------|-------|-------|-------|--------|---------|---|
| | | M | M1 | M2 | M3 | X | Y | Z | A° | MATRIX | |
| EIA (in) | Metric (mm) | ±0.08 | ±0.08 | ±0.05 | ±0.05 | ±0.05 | ±0.05 | ±0.08 | ± 1/2° | (X x Y) | |
| 0402 | 1005 | 4.45 | 3.89 | 1.96 | 2.79 | 1.85 | 1.07 | 1.04 | 7 | 16 X 23 | 368 |
| 0504 | 1210 | 5.97 | 5.74 | 4.37 | 4.32 | 2.03 | 2.29 | 1.40 | 5 | 10 X 10 | 100 |
| 0603 | 1608 | 4.45 | 3.89 | 1.96 | 2.79 | 1.85 | 1.07 | 1.04 | 7 | 16 X 23 | 368 |
| 0805 | 2012 | 5.89 | 4.72 | 4.60 | 4.34 | 1.57 | 2.34 | 0.91 | 10 | 10 X 10 | 100 |
| 1005 | 2512 | 5.84 | 6.10 | 4.83 | 3.56 | 1.52 | 2.79 | 1.91 | 5 | 12 X 9 | 108 |
| 1206 ^{1,2} | 3216 | 4.93 | 5.79 | 4.90 | 3.15 | 1.70 | 3.30 | 1.65 | 5 | 14 X 9 | 126 |
| 1206 ^{1,3} | 3216 | 6.35 | 6.35 | 9.53 | 4.24 | 2.54 | 5.08 | 1.78 | 5 | 10 X 5 | 50 |
| 1210 | 3225 | 5.51 | 6.20 | 5.46 | 4.42 | 2.79 | 3.68 | 2.03 | 5 | 10 X 8 | 80 |
| 1808 | 4520 | 6.88 | 7.24 | 7.26 | 6.17 | 3.81 | 5.08 | 1.91 | 5 | 7 X 6 | 42 |
| 1812 | 4532 | 6.88 | 7.24 | 7.26 | 6.17 | 3.81 | 5.08 | 1.91 | 5 | 7 X 6 | 42 |
| 1825 | 4564 | 8.08 | 9.19 | 10.77 | 8.64 | 6.10 | 8.13 | 0.81 | 5 | 5 X 4 | 20 |
| 2220 | 5650 | 8.08 | 9.19 | 10.77 | 8.64 | 6.10 | 8.13 | 0.81 | 5 | 5 X 4 | 20 |
| 2225 | 5664 | 8.08 | 9.19 | 10.77 | 8.64 | 6.10 | 8.13 | 0.81 | 5 | 5 X 4 | 20 |

¹ Packaging of 1206 (3216 metric) case size capacitors is dependent upon the nominal chip thickness of the device. See "Capacitance Range/Selection Waterfall" and "Chip Thickness/Tape & Reel Packaging Quantities" to identify the nominal chip thickness of the capacitor.

² Assigned to 1206 (3216 metric) case size capacitors with nominal thickness of ≤ 1.25mm (0.049 inches).

³ Assigned to 1206 (3216 metric) case size capacitors with nominal thickness of > 1.25mm (0.049 inches).

KEMET Electronics Corporation Sales Offices

For a complete list of our global sales offices, please visit www.kemet.com/sales.

Disclaimer

YAGEO Corporation and its affiliates do not recommend the use of commercial or automotive grade products for high reliability applications or manned space flight.

All product specifications, statements, information and data (collectively, the "Information") in this datasheet are subject to change. The customer is responsible for checking and verifying the extent to which the Information contained in this publication is applicable to an order at the time the order is placed. All Information given herein is believed to be accurate and reliable, but it is presented without guarantee, warranty, or responsibility of any kind, expressed or implied.

Statements of suitability for certain applications are based on KEMET Electronics Corporation's ("KEMET") knowledge of typical operating conditions for such applications, but are not intended to constitute – and KEMET specifically disclaims – any warranty concerning suitability for a specific customer application or use. The Information is intended for use only by customers who have the requisite experience and capability to determine the correct products for their application. Any technical advice inferred from this Information or otherwise provided by KEMET with reference to the use of KEMET's products is given gratis, and KEMET assumes no obligation or liability for the advice given or results obtained.

Although KEMET designs and manufactures its products to the most stringent quality and safety standards, given the current state of the art, isolated component failures may still occur. Accordingly, customer applications which require a high degree of reliability or safety should employ suitable designs or other safeguards (such as installation of protective circuitry or redundancies) in order to ensure that the failure of an electrical component does not result in a risk of personal injury or property damage.

Although all product-related warnings, cautions and notes must be observed, the customer should not assume that all safety measures are indicated or that other measures may not be required.

KEMET is a registered trademark of KEMET Electronics Corporation.

Looking for pricing, stock, or lifecycle information?

Click below to explore more details on WIN SOURCE:

 [View C0603H470J5GAC on WIN SOURCE](#)

 [Kemet Information](#)

Optimize Your Supply Chain with WIN SOURCE Solutions

-  Global Sourcing Solution
-  Obsolete Management
-  Cost Control Management
-  Shortage Management
-  Alternative Solution
-  Excess Inventory Management