



THE DATASHEET OF
0853.0571



Cover for Holder OGN



4W/10A

See below:
[Approvals and Compliances](#)

Description

- Cover for OGN fuseholders
- Available in different colors and materials
- Heat-resistant variant available for reflow soldering

References

Mating cover to [OGN](#); [OGN Pre-Assembled](#)

Weblinks

[pdf data sheet](#), [html datasheet](#), [General Product Information](#), [Distributor-Stock-Check](#), [Detailed request for product](#), [Microsite](#)

Technical Data

| | |
|----------------------------|---|
| Fuse-Link | 5 x 20mm |
| Rated Power Acceptance IEC | 4W / 10A @ Ta 23°C 2.5 W / 10 A with transparent cover |
| Admissible Ambient Temp. | -40°C to 85°C |
| Material: Cover | Thermoplastic UL 94V-0 |
| Storage Conditions | 0°C to 60°C, max. 70% r.h. |



Approvals and Compliances

Detailed information on product approvals, code requirements, usage instructions and detailed test conditions can be looked up in [Details about Approvals](#)

SCHURTER products are designed for use in industrial environments. They have approvals from independent testing bodies according to national and international standards. Products with specific characteristics and requirements such as required in the automotive sector according to IATF 16949, medical technology according to ISO 13485 or in the aerospace industry can be offered exclusively with customer-specific, individual agreements by SCHURTER.



Product standards

Product standards that are referenced

| Organization | Design | Standard | Description |
|---|-----------------------|----------------------|--|
|  | Designed according to | IEC 60127-6 | Miniature fuses. Part 6. Fuse-holders for miniature fuse-links |
|  | Designed according to | UL 4248-1 | Industrial Control Equipment |
|  | Designed according to | CSA C22.2 no. 4248.1 | Industrial Control Equipment |





Application standards

Application standards where the product can be used

| Organization | Design | Standard | Description |
|---|--------------------------------|----------------|--|
|  | Suitable for applications acc. | IEC/UL 62368-1 | Audio/video, information and communication technology equipment - Part 1: Safety requirements |
|  | Suitable for applications acc. | IEC 60335-1 | Safety of electrical appliances for household and similar purposes. Meets the requirements for appliances in unattended use. This includes the enhanced requirements of glow wire tests acc. to IEC 60695-2-11 or -12 & -13. |

Compliances

The product complies with following Guide Lines

| Identification | Details | Initiator | Description |
|--|----------------------------|-------------|---|
|  | RoHS | SCHURTER AG | Directive RoHS 2011/65/EU, Amendment (EU) 2015/863 |
|  | China RoHS | SCHURTER AG | The law SJ / T 11363-2006 (China RoHS) has been in force since 1 March 2007. It is similar to the EU directive RoHS. |
|  | REACH | SCHURTER AG | On 1 June 2007, Regulation (EC) No 1907/2006 on the Registration, Evaluation, Authorization and Restriction of Chemicals 1 (abbreviated as "REACH") entered into force. |
|  | White Paper Glow wire test | SCHURTER AG | Meets the requirements of IEC 60335-1 for appliances in unattended use. This includes the enhanced requirements of glow wire tests acc. to IEC 60695-2-11 or -12 & -13. |

Dimension [mm]

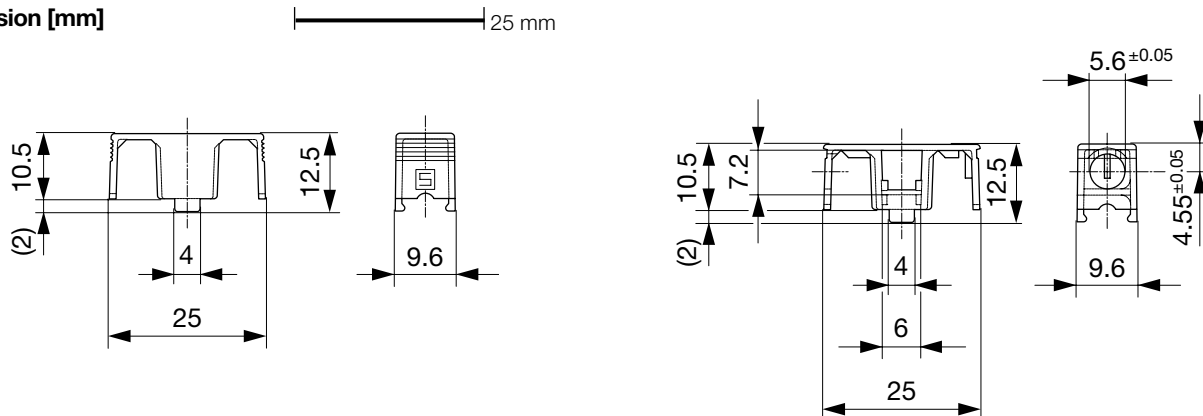

Variants 0853.0551, 0853.0571, 0853.0573 and 0853.0575

Variant 0853.0576

| Accessories | Description | Color | Order Number |
|-------------|------------------------------|-------------|--------------|
| Cover | for 245 °C Reflow | black | 0853.0571 |
| Cover | for 260 °C Reflow | black | 0853.0573 |
| Cover | black (not for reflow) | black | 0853.0575 |
| Cover | with Clamp for 245 °C Reflow | black | 0853.0576 |
| Cover | Transparent (not for reflow) | transparent | 0853.0551 |

 Most Popular.



Availability for all products can be searched real-time: <https://www.schurter.com/en/info-center/support-tools/stock-check-distributors>

Packaging Unit

Bulk (100 pcs.)

Looking for pricing, stock, or lifecycle information?

Click below to explore more details on WIN SOURCE:

-  [View 0853.0571 on WIN SOURCE](#)
-  [Schurter Inc. Information](#)

Optimize Your Supply Chain with WIN SOURCE Solutions

-  Global Sourcing Solution
-  Obsolete Management
-  Cost Control Management
-  Shortage Management
-  Alternative Solution
-  Excess Inventory Management