



**THE DATASHEET OF  
QM23240TR13**



### Product Overview

The QPC6324 is a Silicon on Insulator (SOI) single-pole, double-throw (SPDT) switch, designed for use in 4G/5G wireless infrastructure applications and other high-performance communications systems. It offers high isolation with excellent linearity and power handling capability. No blocking capacitors are necessary on the RF ports. The design is non-reflective such that the RFX ports are terminated into 50 Ω in the off state. The QPC6324 is +1.8V logic compatible.

The QPC6324 is packaged in a RoHS-compliant, compact QFN 4x4 mm surface-mount leadless package.

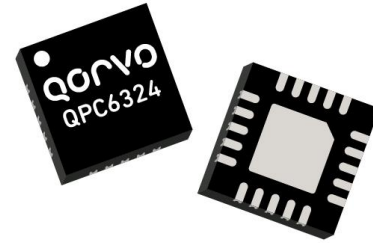

QFN 20 Pin 4 mm x 4 mm leadless SMT Package

### Functional Block Diagram

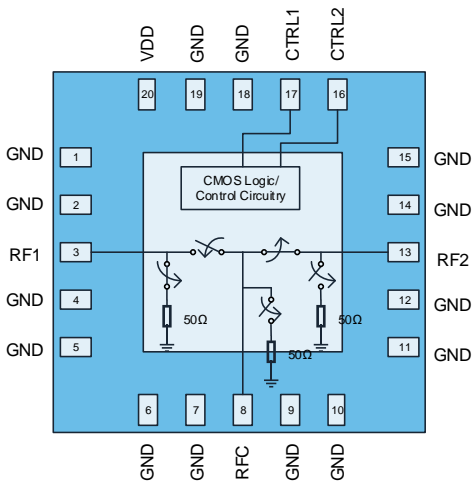

Top View

### Key Features

- 5 MHz to 6000 MHz Operation
- Non-Reflective (RFX ports)
- Terminated All-Off State mode
- No Blocking Caps needed unless voltage is on RF Line
- High Isolation: RFC-RFX: 63 dB at 2 GHz  
RFX-RFX: 63 dB at 2 GHz
- +1.8 V Logic Compatible

### Applications

- Wireless Infrastructure
- Macro or picocell base stations
- TDD-based architectures

### Ordering Information

Part No.	Description
QPC6324TR13	2500 pcs on a 13" reel
QPC6324EVB-01	Evaluation board

## Absolute Maximum Ratings

Parameter	Rating	
Storage Temperature	-50 to 150 °C	
VDD	+6 V	
V <sub>CTRL1/2</sub>	High	+6 V
	Low	-0.2 V
Pin max (RFC-RFX), CW, 50 Ω	37 dBm	
Pin max (RFX-TERM), CW, 50 Ω	31 dBm	

Operation of this device outside the parameter ranges given above may cause permanent damage.

## Recommended Operating Conditions

Parameter	Min	Typ	Max	Units
V <sub>DD</sub>	+2.7	+5	+5.5	V
T <sub>CASE</sub>	-40		+110	°C
T <sub>j</sub> at MTTF>10 <sup>6</sup> hrs			125	°C

Electrical specifications are measured at specified test conditions. Specifications are not guaranteed over all recommended operating conditions.

## Electrical Specifications

Test conditions, unless otherwise noted: Temp = 25°C, VDD = +5V.

Parameter	Conditions	Min	Typ	Max	Units
Operational Frequency Range		5		6000	MHz
Insertion Loss <sup>(1)</sup>	100 – 2000 MHz		0.9	1.15	dB
	2000 – 4000 MHz		1.0	1.25	dB
	4000 – 5000 MHz		1.05	1.3	dB
	5000 - 6000 MHz		1.1	1.35	dB
Insertion Loss Ripple	In any 400 MHz band		0.03		dB
Isolation, RFC-RFX <sup>(1)</sup>	100 - 2000 MHz	55	61.5		dB
	2000 – 4000 MHz	50	57		dB
	4000 – 5000 MHz	48	54		dB
	5000 - 6000 MHz	44	50		dB
Isolation, RFX-RFX <sup>(1)</sup>	100 - 2000 MHz	57	63		dB
	2000 – 4000 MHz	50	57		dB
	4000 – 5000 MHz	48	54		dB
	5000 - 6000 MHz	44	50		dB
Return Loss, RFC <sup>(2)</sup>	100 - 4000 MHz	14	17		dB
	4000 – 5000 MHz	13	16		dB
	5000 - 6000 MHz	14	17		dB
Return Loss, RFX <sup>(2)</sup>	100 - 4000 MHz	13	16		dB
	4000 – 5000 MHz	12	15		dB
	5000 - 6000 MHz	15	18		dB
Return Loss	RFC Terminated, 2000 MHz		22		dB
	RFC Terminated, 6000 MHz		15		dB
Return Loss	RFX Terminated, 2000 MHz		20		dB
	RFX Terminated, 6000 MHz		13		dB

Note:

1. Production screen of product is done only at 2GHz and 6GHz.
2. Guaranteed by design only. Not tested in production.

## Electrical Specifications Contd.

Test conditions, unless otherwise noted: Temp = 25°C, VDD = +5V.

Parameter	Conditions	Min	Typ	Max	Units
Input P1dB	RFC-RFX, 2600 MHz	34	37		dBm
Input IP3	RFC-RFX, 2600 MHz, 13dBm/tone, 1MHz Δf	55	60		dBm
Switching Time	Turn-on, (50% Ctrl to 90% RF)		180		ns
	Turn-off, (50% Ctrl to 10% RF)		150		ns
	Turn-on, (50% Ctrl to 99% RF)		417		ns
	Turn-off, (50% Ctrl to 1% RF)		210		ns
Supply Current, IDD	VDD = +5V		90	200	μA
Control Voltage, V <sub>CTRL1/2</sub>	VIH	1.2		VDD	V
	VIL	0		0.63	V
Control Current, I <sub>CTRL1/2</sub>			1		μA
Spur Level	Any RF ports, >100MHz		< -125		dBm
Thermal Resistance			60		°C/W

## Power Handling Specification (MTTF≥10<sup>6</sup> Hours)

Input Port	Port State	Power(dBm)	T <sub>CASE</sub>
RFC, RF1 or RF2 <sup>1,3</sup>	ON	34.2	85°C
		31.6	105°C
		30.5	110°C
		29.0	115°C
		26.0	120°C
RFC, RF1 or RF2	OFF	28.4	85°C
		25.0	105°C
		23.8	110°C
		22.0	115°C
		19.5	120°C
RFC, RF1 and RF2 simultaneous <sup>2</sup>	All OFF	27.6	85°C
		24.2	105°C
		23.0	110°C
		21.5	115°C
		18.5	120°C

Note

1. For high VSWR loads, this power reduces by 4dB
2. Power is on each input, not total
3. For < 20MHz, max power reduces by 6dB



**Performance Plots**

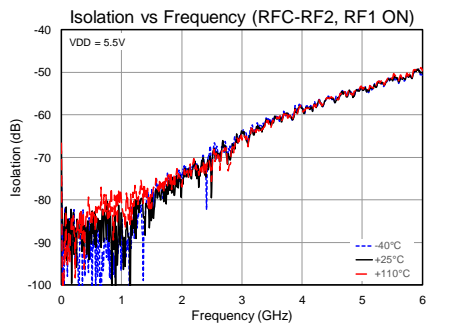
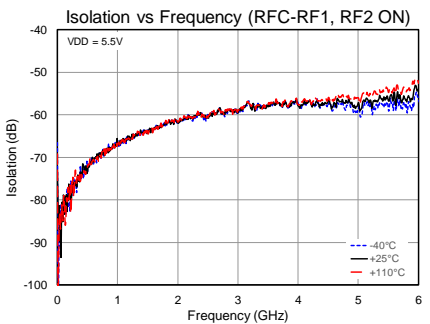
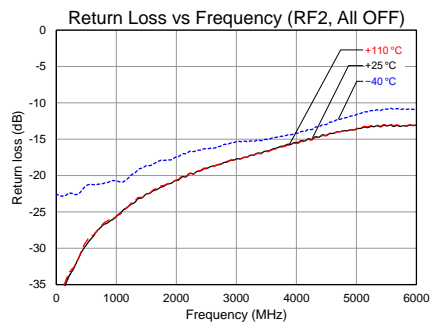
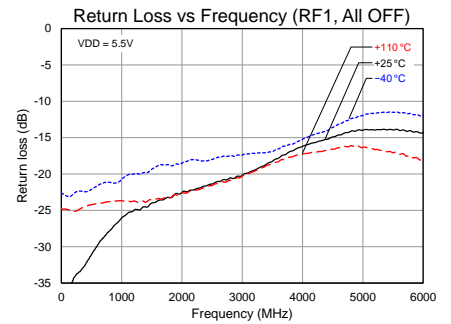
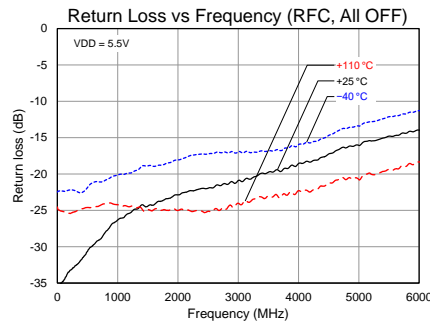
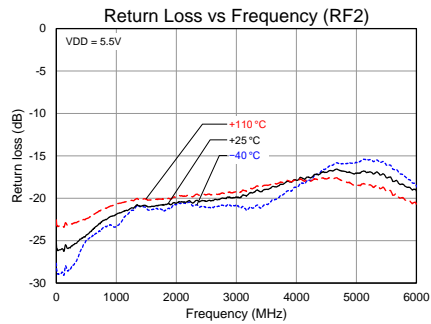
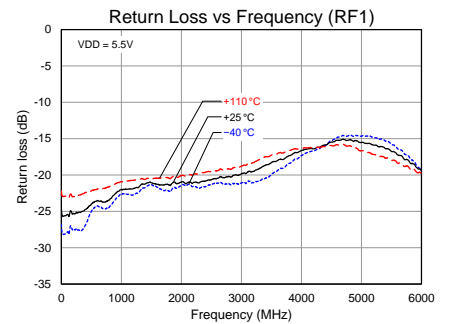
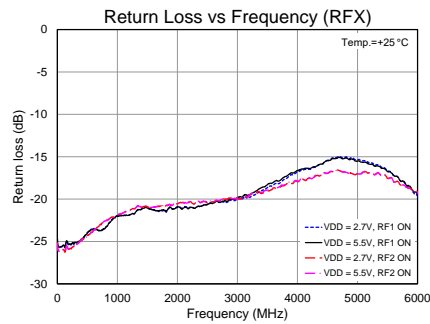
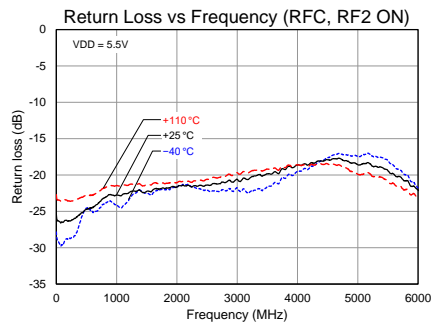
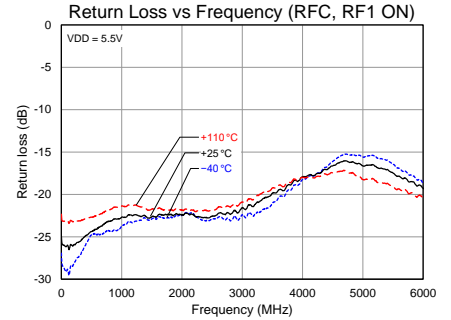
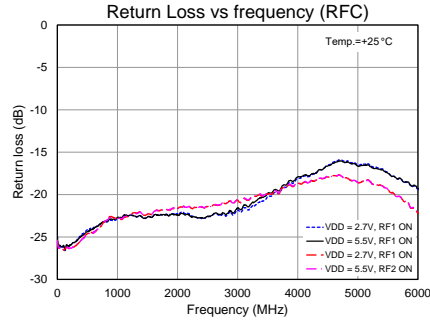
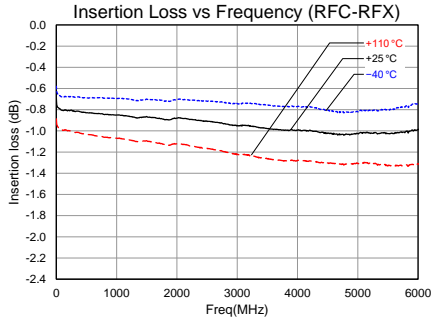

**Performance Plots Contd.**

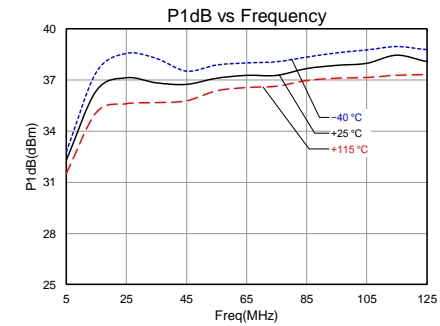
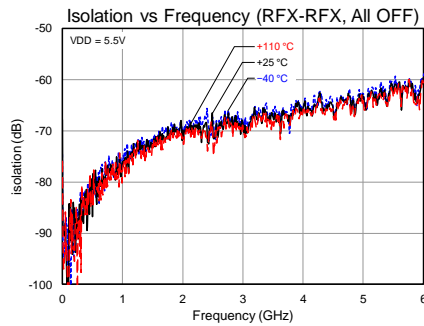
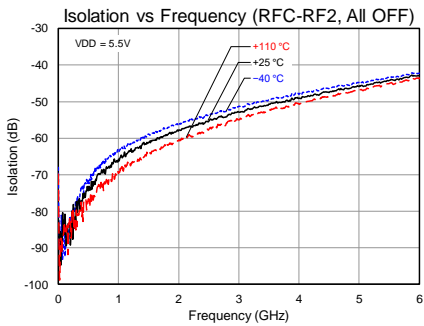
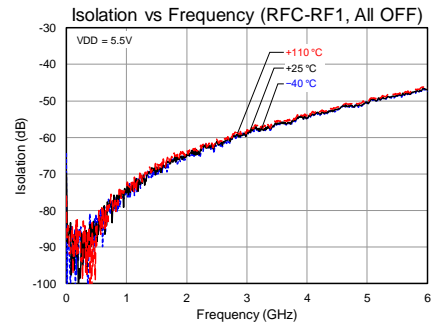
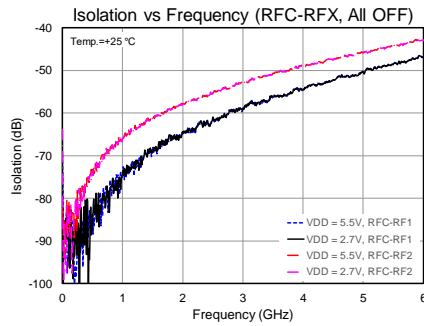
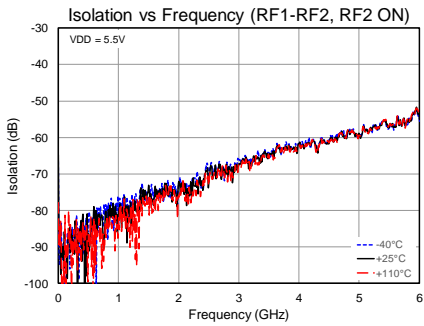
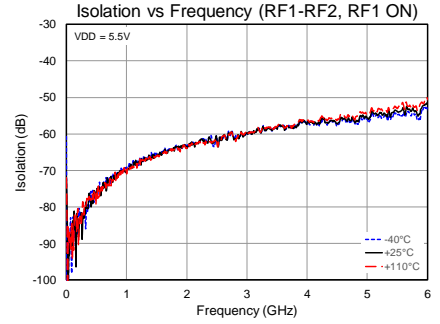
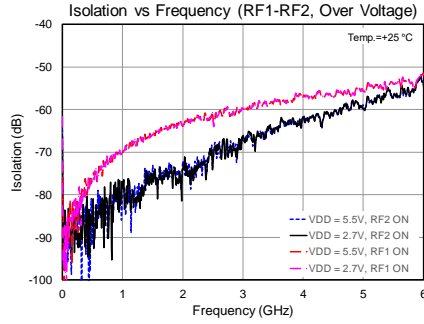
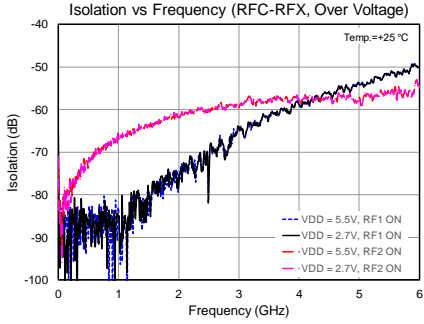

## Pin Configuration and Description

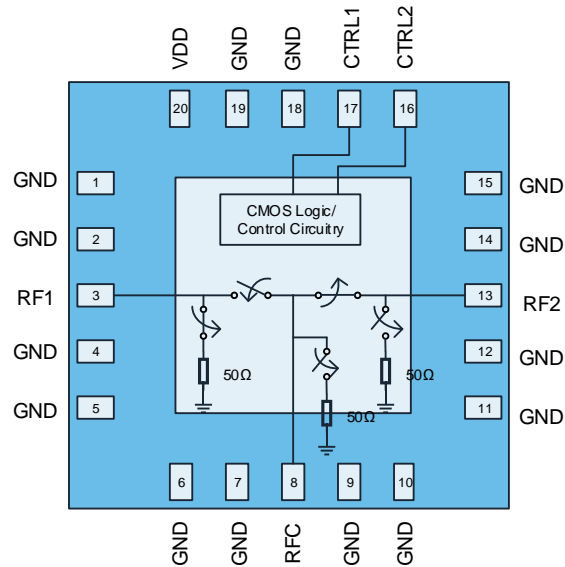

Top View

Pin No.	Label	Description
1,2,5,6,9,10,11,12,14,15	GND	No internal connection, recommend grounding on PCB board for proper mounting integrity.
4, 7, 18, 19	GND	Internally connected and must be grounded on PCB board.
3	RF1	Switch output port 1. Internally pulled to 0V (GND).
8	RFC	Switch common port. Internally pulled to 0V (GND).
13	RF2	Switch output port 2. Internally pulled to 0V (GND).
16	CTRL2	Switch control input 2
17	CTRL1	Switch control input 1
20	VDD	Supply voltage. Bypassing capacitor(s) recommended.
Backside Pad	GND	Ground connection. The back side of the package should be connected to the ground plane though as short of a connection as possible. PCB via holes under the device are required.

## Package Marking and Dimensions

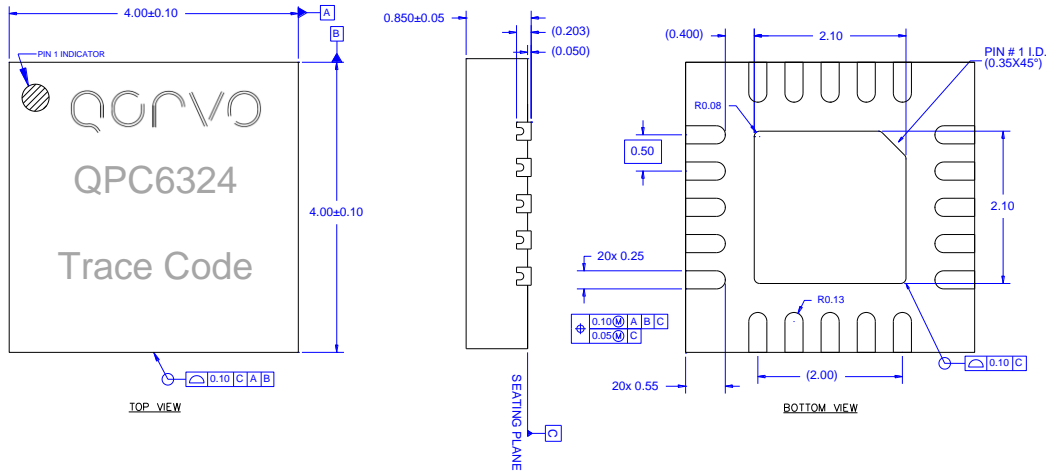

### Notes:

1. All dimensions are in millimeters. Angles are in degrees.
2. Dimension and tolerance formats conform to ASME Y14.4M-1994.
3. The terminal #1 identifier and terminal numbering conform to JESD 95-1 SPP-012.

## PCB Mounting Pattern

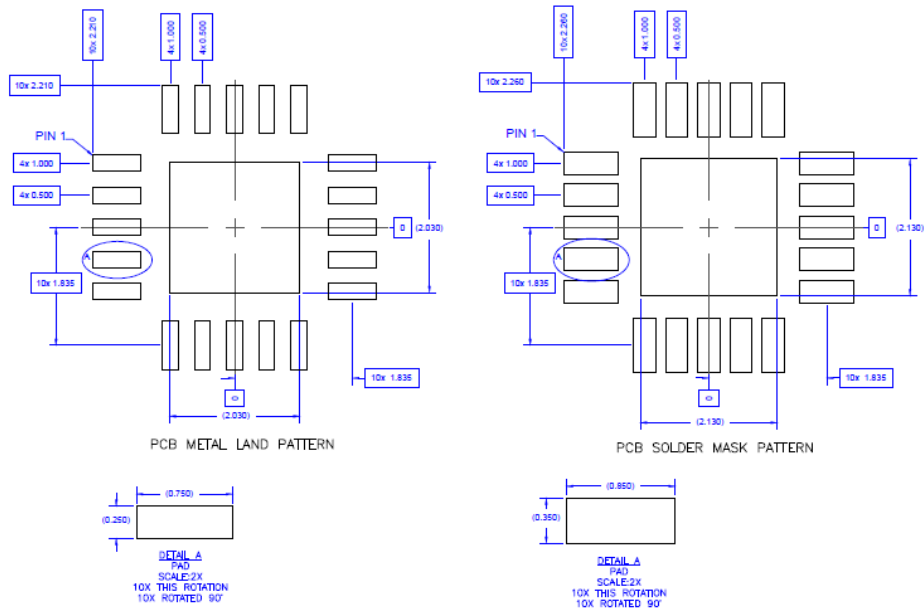

### Notes:

1. All dimensions are in millimeters. Angles are in degrees.
2. Use 1 oz. copper minimum for top and bottom layer metal.
3. Via holes are required under the backside paddle of this device for proper RF/DC grounding and thermal dissipation.
4. Do not remove or minimize via hole structure in the PCB. Thermal and RF grounding is critical.
5. We recommend a  $0.35$  mm ( $\#80/0.135$ " ) diameter bit for drilling via holes and a final plated thru diameter of  $0.25$  mm ( $0.01$ " ).
6. Ensure good package backside paddle solder attach for reliable operation and best electrical performance.

**Tape and Reel Information – Carrier and Cover Tape Dimensions**

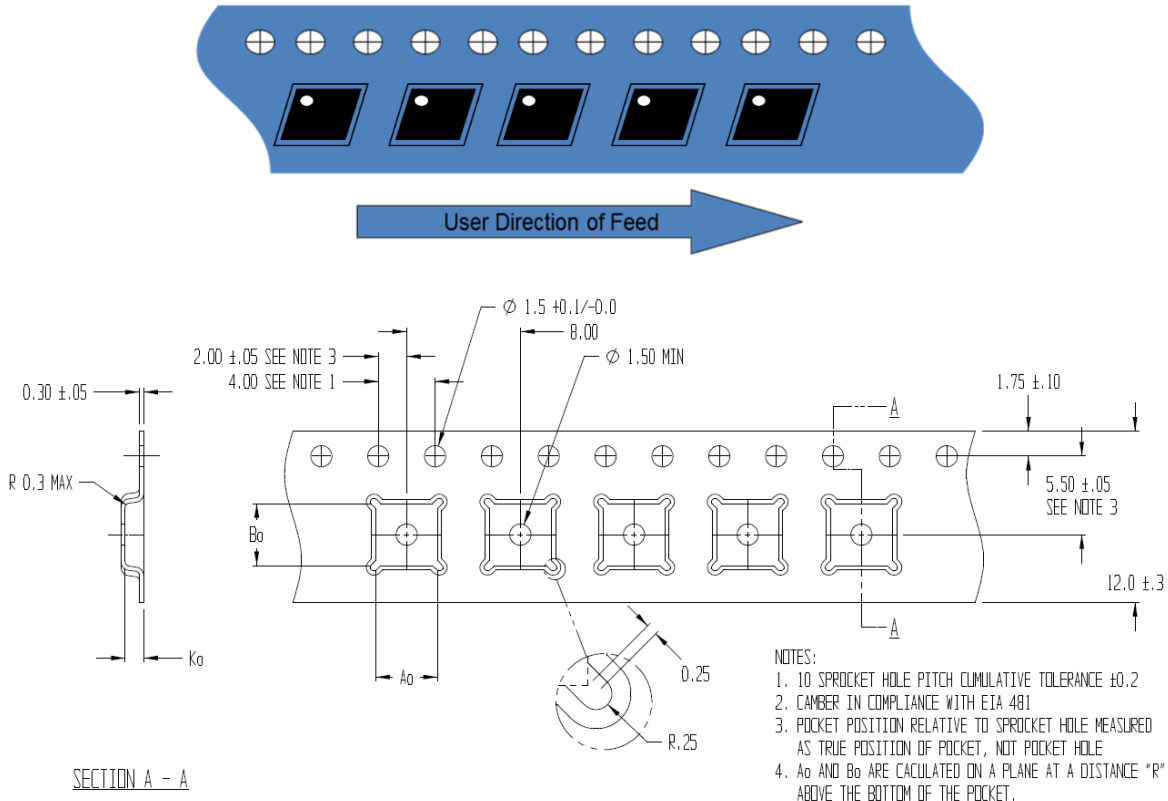

Feature	Measure	Symbol	Size (in)	Size (mm)
Cavity	Length	A0	0.171	4.35
	Width	B0	0.171	4.35
	Depth	K0	0.051	1.10
	Pitch	P1	0.315	8.00
Centerline Distance	Cavity to Perforation - Length Direction	P2	0.079	2.00
	Cavity to Perforation - Width Direction	F	0.217	5.50
Cover Tape	Width	C	0.362	9.20
Carrier Tape	Width	W	0.472	12.0

**Tape and Reel Information – Reel Dimensions (13")**

Standard T/R size = 2,500 pieces on a 13" reel.

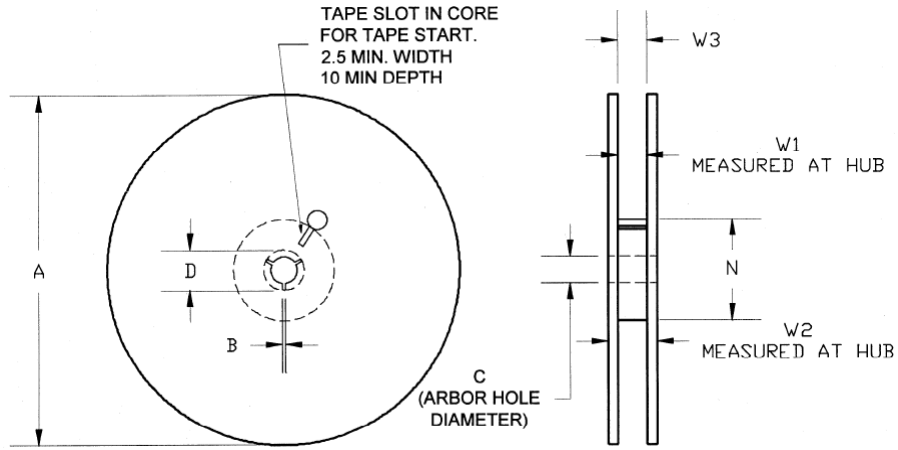

Feature	Measure	Symbol	Size (in)	Size (mm)
Flange	Diameter	A	12.992	330.0
	Thickness	W2	0.717	18.2
	Space Between Flange	W1	0.504	12.8
Hub	Outer Diameter	N	4.016	102.0
	Arbor Hole Diameter	C	0.512	13.0
	Key Slit Width	B	0.079	2.0
	Key Slit Diameter	D	0.787	20.0

**Tape and Reel Information – Tape Length and Label Placement**

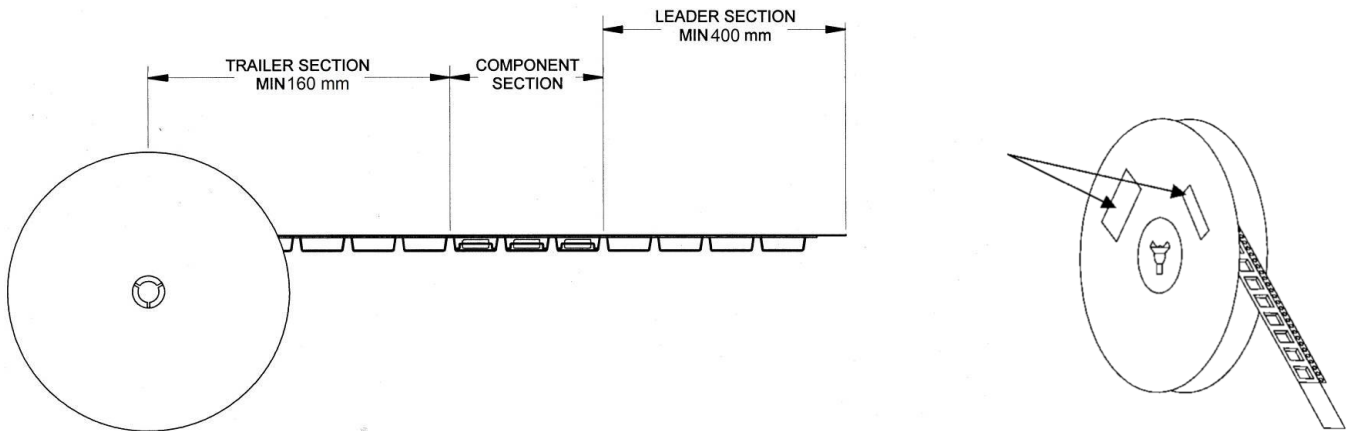

- Notes:
1. Empty part cavities at the trailing and leading ends are sealed with cover tape. See EIA 481-1-A.
  2. Labels are placed on the flange opposite the sprockets in the carrier tape.

## Handling Precautions

Parameter	Rating	Standard
ESD – Human Body Model (HBM)	Class 2	ESDA / JEDEC JS-001-2012
ESD – Charged Device Model (CDM)	Class C3	JEDEC JESD22-C101F
MSL – Moisture Sensitivity Level	Level 1	IPC/JEDEC J-STD-020



Caution!  
ESD-Sensitive Device

## Solderability

Compatible with both lead-free (260°C max. reflow temp.) and tin/lead (245°C max. reflow temp.) soldering processes. Solder profiles available upon request.

Contact plating: NiPdAu (*Plating thickness: Ni 0.5000–2.0066 μm; Pd 0.01999–0.15011 μm; Au 0.00254–0.01501 μm*)

## RoHS Compliance

This part is compliant with 2011/65/EU RoHS directive (Restrictions on the Use of Certain Hazardous Substances in Electrical and Electronic Equipment) as amended by Directive 2015/863/EU.

This product also has the following attributes:

- Lead Free
- Halogen Free (Chlorine, Bromine)
- Antimony Free
- TBBP-A (C<sub>15</sub>H<sub>12</sub>Br<sub>4</sub>O<sub>2</sub>) Free
- SVHC Free



## Contact Information

For the latest specifications, additional product information, worldwide sales and distribution locations:

**Web:** [www.qorvo.com](http://www.qorvo.com)

**Tel:** 1-844-890-8163

**Email:** [customer.support@qorvo.com](mailto:customer.support@qorvo.com)

## Important Notice

The information contained herein is believed to be reliable; however, Qorvo makes no warranties regarding the information contained herein and assumes no responsibility or liability whatsoever for the use of the information contained herein. All information contained herein is subject to change without notice. Customers should obtain and verify the latest relevant information before placing orders for Qorvo products. The information contained herein or any use of such information does not grant, explicitly or implicitly, to any party any patent rights, licenses, or any other intellectual property rights, whether with regard to such information itself or anything described by such information. **THIS INFORMATION DOES NOT CONSTITUTE A WARRANTY WITH RESPECT TO THE PRODUCTS DESCRIBED HEREIN, AND QORVO HEREBY DISCLAIMS ANY AND ALL WARRANTIES WITH RESPECT TO SUCH PRODUCTS WHETHER EXPRESS OR IMPLIED BY LAW, COURSE OF DEALING, COURSE OF PERFORMANCE, USAGE OF TRADE OR OTHERWISE, INCLUDING THE IMPLIED WARRANTIES OF MERCHANTABILITY AND FITNESS FOR A PARTICULAR PURPOSE.**

Without limiting the generality of the foregoing, Qorvo products are not warranted or authorized for use as critical components in medical, life-saving, or life-sustaining applications, or other applications where a failure would reasonably be expected to cause severe personal injury or death.

Copyright 2020 © Qorvo, Inc. | Qorvo is a registered trademark of Qorvo, Inc.

# Mouser Electronics

Authorized Distributor

Click to View Pricing, Inventory, Delivery & Lifecycle Information:

[Qorvo:](#)

[QPC6324TR13](#) [QPC6324EVB01](#) [QPC6324SR](#) [QPC6324EVB-01](#)

## Looking for pricing, stock, or lifecycle information?

Click below to explore more details on WIN SOURCE:

 [View QM23240TR13 on WIN SOURCE](#)

 [Qorvo US Inc. Information](#)

## Optimize Your Supply Chain with WIN SOURCE Solutions

-  Global Sourcing Solution
-  Obsolete Management
-  Cost Control Management
-  Shortage Management
-  Alternative Solution
-  Excess Inventory Management