



THE DATASHEET OF ERA-5+



Drop-In

Monolithic Amplifier

DC-4 GHz

Product Features

- DC-4 GHz
- Single voltage supply
- Internally matched to 50 ohms
- Unconditionally stable
- Low performance variation over temperature
- Transient protected
- Aqueous washable
- Protected by US Patent 6,943,629

Typical Applications

- Cellular/ PCS/ 3G Base Station
- CATV, Cable Modem & DBS
- Fixed Wireless & WLAN
- Microwave Radio & Test Equipment

General Description

ERA-5+ (RoHS compliant) is a wideband amplifier offering high dynamic range. It has repeatable performance from lot to lot. It is enclosed in an Micro-X package. ERA-5+ uses Darlington configuration and is fabricated using InGaP HBT technology. Expected MTTF is 940 years at 85°C case temperature.



Generic photo used for illustration purposes only

ERA-5+

CASE STYLE: VV105

+RoHS Compliant

The +Suffix identifies RoHS Compliance. See our web site for RoHS Compliance methodologies and qualifications

simplified schematic and pin description

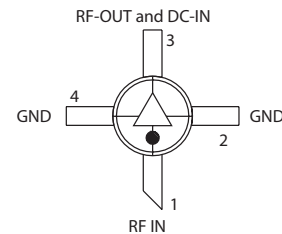
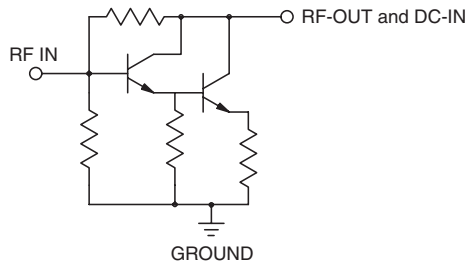

Function	Pin Number	Description
RF IN	1	RF input pin. This pin requires the use of an external DC blocking capacitor chosen for the frequency of operation.
RF-OUT and DC-IN	3	RF output and bias pin. DC voltage is present on this pin; therefore a DC blocking capacitor is necessary for proper operation. An RF choke is needed to feed DC bias without loss of RF signal due to the bias connection, as shown in "Recommended Application Circuit".
GND	2,4	Connections to ground. Use via holes as shown in "Suggested Layout for PCB Design" to reduce ground path inductance for best performance.

Notes

- A. Performance and quality attributes and conditions not expressly stated in this specification document are intended to be excluded and do not form a part of this specification document.
B. Electrical specifications and performance data contained in this specification document are based on Mini-Circuit's applicable established test performance criteria and measurement instructions.
C. The parts covered by this specification document are subject to Mini-Circuits' standard limited warranty and terms and conditions (collectively, "Standard Terms"); Purchasers of this part are entitled to the rights and benefits contained therein. For a full statement of the Standard Terms and the exclusive rights and remedies thereunder, please visit Mini-Circuits' website at www.minicircuits.com/MCLStore/terms.jsp



Electrical Specifications at 25°C and 65mA, unless noted

Parameter	Min.	Typ.	Max.	Units	Cpk	
Frequency Range*	DC		4	GHz		
Gain	f=0.1GHz f=1 GHz f=2 GHz f=3 GHz f=4 GHz	19 — 16 16 12	20.2 19.5 18.5 16.7 14.3	22 dB	≥1.5	
Magnitude of Gain Variation versus Temperature (values are negative)	f=0.1GHz f=1 GHz f=2 GHz f=3 GHz f=4 GHz		.0025 .0034 .0043 .0052 .0065	.005 .007 .0085 .0105 .013	dB/°C	
Input Return Loss	f=0.1 GHz f=2 GHz f=4 GHz		21 23 21	dB		
Output Return Loss	f=0.1 GHz f=2 GHz f=4 GHz		30 26 17	dB		
Reverse Isolation	f=2 GHz	19	22	dB		
Output Power @1 dB compression	f=0.1 GHz f=1 GHz f=2 GHz f=4 GHz	16.5 16.5 15.5	18.4 18.4 17 12.5	dBm	≥1.5	
Saturated Output Power (at 3dB compression)	f=0.1 GHz f=1 GHz f=2 GHz		19.5 18.5 18	dBm		
Output IP3	f=0.1 GHz f=1 GHz f=2 GHz f=4 GHz	30 30 26	33 33 30 26	dBm	≥1.5	
Noise Figure	f=0.1GHz f=2 GHz f=4 GHz		3.5 3.5 3.5	4.5 4.5 4.5	dB	≥1.5
Group Delay	f=2 GHz		90	psec		
Recommended Device Operating Current			65	mA		
Device Operating Voltage		4.5	4.9	5.3	V	≥1.5
Device Voltage Variation vs. Temperature at 65mA			-3.2	mV/°C		
Device Voltage Variation vs. Current at 25°C			6.9	mV/mA		
Thermal Resistance, junction-to-case ¹			128	°C/W		

*Guaranteed specification DC-4 GHz. Low frequency cut off determined by external coupling capacitors.

Absolute Maximum Ratings

Parameter	Ratings
Operating Temperature*	-45°C to 85°C
Storage Temperature	-65°C to 150°C
Operating Current	85mA
Power Dissipation	451mW
Input Power	13 dBm

Note: Permanent damage may occur if any of these limits are exceeded.

These ratings are not intended for continuous normal operation.

¹Case is defined as ground leads.

*Based on typical case temperature rise 10°C above ambient.

Notes

- A. Performance and quality attributes and conditions not expressly stated in this specification document are intended to be excluded and do not form a part of this specification document.
- B. Electrical specifications and performance data contained in this specification document are based on Mini-Circuit's applicable established test performance criteria and measurement instructions.
- C. The parts covered by this specification document are subject to Mini-Circuits standard limited warranty and terms and conditions (collectively, "Standard Terms"); Purchasers of this part are entitled to the rights and benefits contained therein. For a full statement of the Standard Terms and the exclusive rights and remedies thereunder, please visit Mini-Circuits' website at www.minicircuits.com/MCLStore/terms.jsp



Product Marking

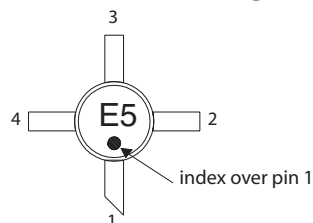

Markings in addition to model number designation may appear for internal quality control purposes.

Additional Detailed Technical Information

Additional information is available on our web site. To access this information enter the model number on our web site home page.

Performance data, graphs, s-parameter data set (.zip file)

Case Style: VV105

Plastic micro-x, .085 body diameter, lead finish: Matte-Tin

Tape & Reel: F4

7" Reels with 20, 50, 100, 200, 500, 1K devices

Suggested Layout for PCB Design: PL-261

Evaluation Board: TB-431-5+

Environmental Ratings: ENV08T2

Recommended Application Circuit

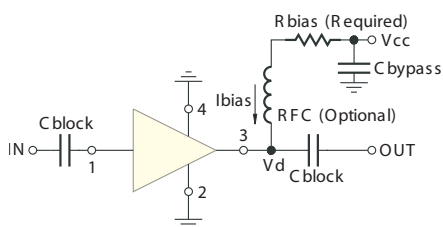

Test Board includes case, connectors, and components (in bold) soldered to PCB

R BIAS	
Vcc	"1%" Res. Values (ohms) for Optimum Biasing
7	33.2
8	48.7
9	63.4
10	78.7
11	95.3
12	110
13	124
14	140
15	158
16	174
17	187
18	205
19	221
20	232

Notes

- A. Performance and quality attributes and conditions not expressly stated in this specification document are intended to be excluded and do not form a part of this specification document.
- B. Electrical specifications and performance data contained in this specification document are based on Mini-Circuit's applicable established test performance criteria and measurement instructions.
- C. The parts covered by this specification document are subject to Mini-Circuits standard limited warranty and terms and conditions (collectively, "Standard Terms"); Purchasers of this part are entitled to the rights and benefits contained therein. For a full statement of the Standard Terms and the exclusive rights and remedies thereunder, please visit Mini-Circuits' website at www.minicircuits.com/MCLStore/terms.jsp



ESD Rating

Human Body Model (HBM): Class 1B (500 v to < 1,000 v) in accordance with ANSI/ESD STM 5.1 - 2001

Machine Model (MM): Class M1 (< 100 v) in accordance with ANSI/ESD STM 5.2 - 1999

MSL Rating

Moisture Sensitivity: MSL1 in accordance with IPC/JEDECJ-STD-020C

NO.	TEST REQUIRED	CONDITION	STANDARD	QUANTITY
1	Visual Inspection	Low Power Microscope Magnification 40x	MIP-IN-0003 (MCT spec)	45 units
2	Electrical Test	Room Temperature	SCD (MCL spec)	45 units
3	SAM Analysis	Less than 10% growth in term of delamination	J-Std-020C (Jedec Standard)	45 units
4	Moisture Sensitivity Level 1	Bake at 125°C for 24 hours Soak at 85°C/85%RH for 168 hours Reflow 3 cycles at 260°C peak	J-Std-020C (Jedec Standard)	45 units

MSL Test Flow Chart

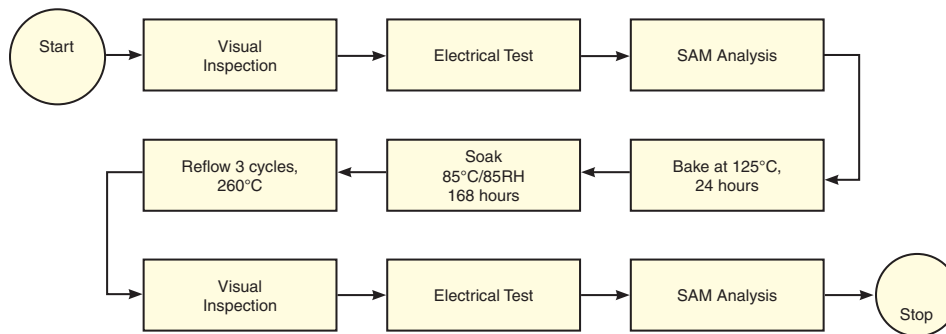



Notes

- A. Performance and quality attributes and conditions not expressly stated in this specification document are intended to be excluded and do not form a part of this specification document.
- B. Electrical specifications and performance data contained in this specification document are based on Mini-Circuit's applicable established test performance criteria and measurement instructions.
- C. The parts covered by this specification document are subject to Mini-Circuits standard limited warranty and terms and conditions (collectively, "Standard Terms"); Purchasers of this part are entitled to the rights and benefits contained therein. For a full statement of the Standard Terms and the exclusive rights and remedies thereunder, please visit Mini-Circuits' website at www.minicircuits.com/MCLStore/terms.jsp



Looking for pricing, stock, or lifecycle information?

Click below to explore more details on WIN SOURCE:

-  [View ERA-5+ on WIN SOURCE](#)
-  [Mini-Circuits Information](#)

Optimize Your Supply Chain with WIN SOURCE Solutions

-  Global Sourcing Solution
-  Obsolete Management
-  Cost Control Management
-  Shortage Management
-  Alternative Solution
-  Excess Inventory Management