



**THE DATASHEET OF
LZ1-00CW02-0055**



OSRAM LZ1-00CW02

Datasheet

Published by **ams-OSRAM AG**

Tobelbader Strasse 30, 8141 Premstaetten, Austria

Phone +43 3136 500-0

ams-osram.com

© All rights reserved



LED ENGIN LuxiGen®

LZ1-00CW02

Industry's most robust high power ceramic package with glass lens for high performance over life.

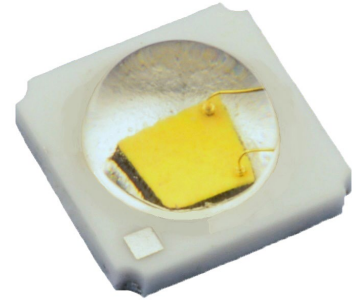

Applications

- Agriculture & Horticulture
- Appliances & Tools
- Entertainment
- Factory Automation
- Home & Building Automation
- Indoor Lighting
- Medical Lighting
- Outdoor & Industrial Lighting
- Projection & Display
- Robotics

Features

- Package: Ceramic package with integrated glass lens
- Chip technology: UX:3
- Typ. Radiation: 90°
- Color: Cx = 0.33, Cy = 0.33 acc. to CIE 1931 (● white)
- Color temperature: 5500K - 6500K
- CRI: 75 (typ.)

Ordering Information

Type	Color temperature	Luminous Flux ¹⁾ $I_F = 1000 \text{ mA}$ Φ_V	Ordering Code
LZ1-00CW02-0055	5500 K	228 ... 445 lm	Q65113A1992
LZ1-00CW02-0065	6500 K	228 ... 445 lm	Q65113A1991

Maximum Ratings

Parameter	Symbol		Values
Operating Temperature	T_{op}	min. max.	-40 °C 150 °C
Storage Temperature	T_{stg}	min. max.	-40 °C 150 °C
Junction Temperature ²⁾	T_j	max.	150 °C
Forward Current ²⁾	I_F	max.	1200 mA
Forward Current pulsed $t \leq 10 \text{ ms}$; $D \leq 0.1$; $T_C = 25 \text{ °C}$	$I_{F \text{ pulse}}$	max.	2000 mA
ESD withstand voltage acc. ANSI/ESDA/JEDEC JS-001 (HBM, Class 0)	V_{ESD}		ESD sensitive device
Reverse voltage ³⁾	V_R		Not designed for reverse operation

Characteristics

$I_F = 1000 \text{ mA}$; $T_C = 25 \text{ }^\circ\text{C}$

Parameter	Symbol		Values
Chromaticity Coordinate ⁴⁾	C_x	typ.	0.33
	C_y	typ.	0.33
Luminous Flux ⁵⁾	Φ_V	typ.	315 lm
Photosynthetic Photon Flux (PPF) ⁵⁾ $\lambda = 400 - 700 \text{ nm}$	Φ_P	typ.	4.8 $\mu\text{mol/s}$
Viewing angle at 50% I_V	2ϕ	typ.	95 °
Forward Voltage ⁶⁾⁵⁾ $I_F = 1000 \text{ mA}$	V_F	min.	2.80 V
		typ.	3.60 V
		max.	3.80 V
Reverse current ³⁾	I_R		Not designed for reverse operation
Color Rendering Index ⁷⁾	R_a	typ.	75
Electrical thermal resistance junction/case	$R_{thJC \text{ elec.}}$	typ.	6.0 K / W

Brightness Groups

Group	Luminous Flux ¹⁾ $I_F = 1000 \text{ mA}$ min. Φ_V	Luminous Flux ¹⁾ $I_F = 1000 \text{ mA}$ max. Φ_V
Q	228 lm	285 lm
R	285 lm	356 lm
S	356 lm	445 lm

Chromaticity Coordinate Groups

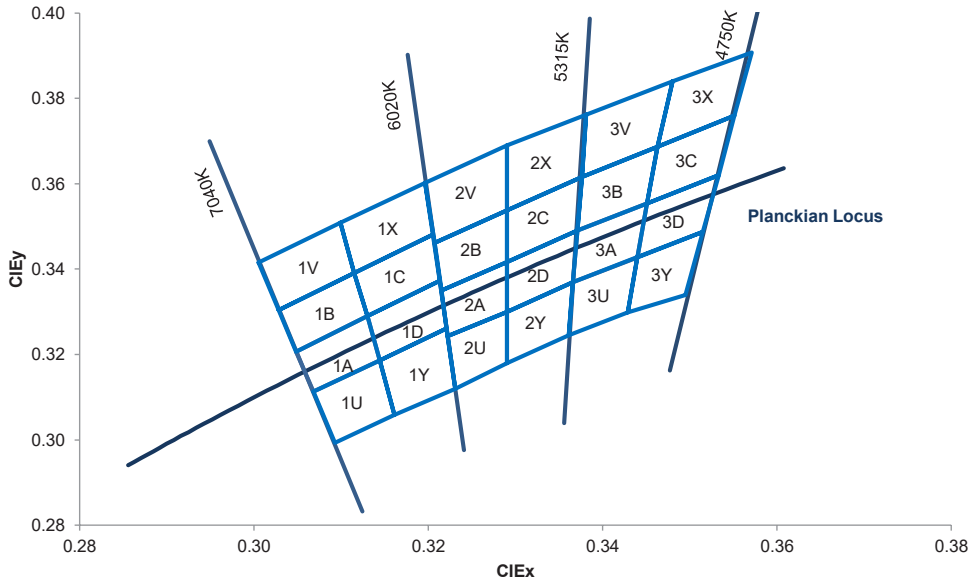

Chromaticity Coordinate Groups ⁴⁾

Group	C _x	C _y	CCT	Group	C _x	C _y	CCT	Group	C _x	C _y	CCT
2A	0.3214	0.3350	5500	2U	0.3222	0.3243	5500	3A	0.3366	0.3369	5500
	0.3290	0.3417	5500		0.3290	0.3300	5500		0.3371	0.3490	5500
	0.3290	0.3300	5500		0.3290	0.3180	5500		0.3451	0.3554	5500
	0.3222	0.3243	5500		0.3231	0.3120	5500		0.3440	0.3427	5500
2B	0.3206	0.3462	5500	2V	0.3196	0.3602	5500	3B	0.3371	0.3490	5500
	0.3290	0.3538	5500		0.3290	0.3690	5500		0.3376	0.3616	5500
	0.3290	0.3417	5500		0.3290	0.3538	5500		0.3463	0.3687	5500
	0.3214	0.3350	5500		0.3206	0.3462	5500		0.3451	0.3554	5500
2C	0.3290	0.3417	5500	2X	0.3290	0.3538	5500	3U	0.3361	0.3245	5500
	0.3290	0.3538	5500		0.3290	0.3690	5500		0.3366	0.3369	5500
	0.3376	0.3616	5500		0.3381	0.3762	5500		0.3440	0.3428	5500
	0.3371	0.3490	5500		0.3376	0.3616	5500		0.3429	0.3299	5500
2D	0.3290	0.3300	5500	2Y	0.3290	0.3180	5500	3V	0.3376	0.3616	5500
	0.3290	0.3417	5500		0.3290	0.3300	5500		0.3381	0.3762	5500
	0.3371	0.3490	5500		0.3366	0.3369	5500		0.3480	0.3840	5500
	0.3366	0.3369	5500		0.3361	0.3245	5500		0.3463	0.3687	5500

Group	Cx	Cy	CCT	Group	Cx	Cy	CCT	Group	Cx	Cy	CCT
1A	0.3048	0.3207	6500	1D	0.3130	0.3290	6500	1X	0.3099	0.3509	6500
	0.3130	0.3290	6500		0.3213	0.3373	6500		0.3196	0.3602	6500
	0.3144	0.3186	6500		0.3221	0.3261	6500		0.3205	0.3481	6500
	0.3068	0.3113	6500		0.3144	0.3186	6500		0.3115	0.3391	6500
1B	0.3028	0.3304	6500	1U	0.3068	0.3113	6500	1Y	0.3144	0.3186	6500
	0.3115	0.3391	6500		0.3144	0.3186	6500		0.3221	0.3261	6500
	0.3130	0.3290	6500		0.3161	0.3059	6500		0.3231	0.3120	6500
	0.3048	0.3207	6500		0.3093	0.2993	6500		0.3161	0.3059	6500
1C	0.3115	0.3391	6500	1V	0.3005	0.3415	6500				
	0.3205	0.3481	6500		0.3099	0.3509	6500				
	0.3213	0.3373	6500		0.3115	0.3391	6500				
	0.3130	0.3290	6500		0.3028	0.3304	6500				

Group Name on Label

Example: Q-1A

Brightness

Color Chromaticity

Q	1A
---	----

Relative Spectral Emission ⁵⁾

$I_{rel} = f(\lambda)$; $I_F = 1000 \text{ mA}$; $T_C = 25 \text{ }^\circ\text{C}$

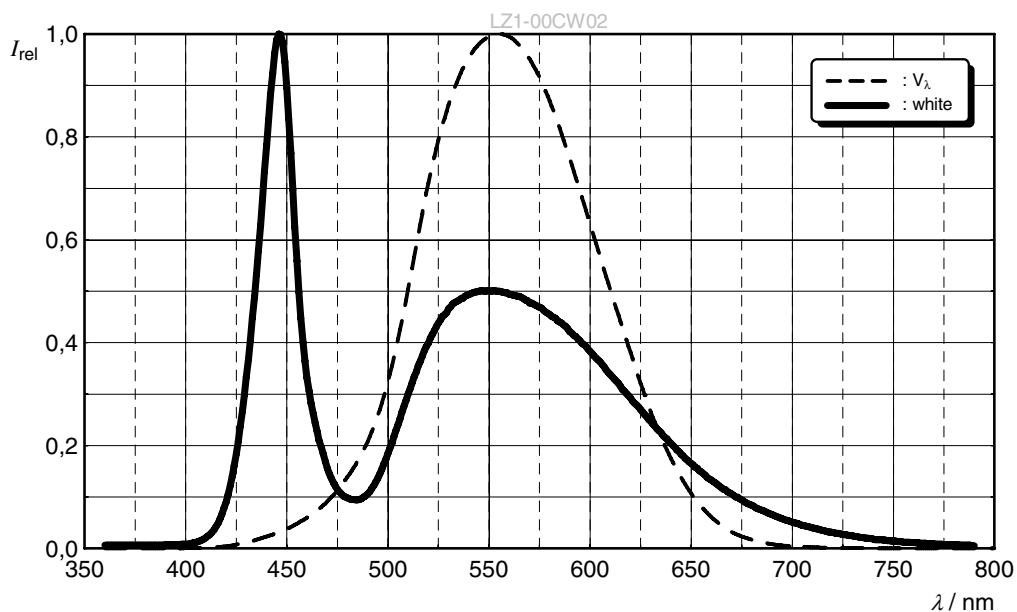

Radiation Characteristics ⁵⁾

$I_{rel} = f(\phi)$; $T_C = 25 \text{ }^\circ\text{C}$

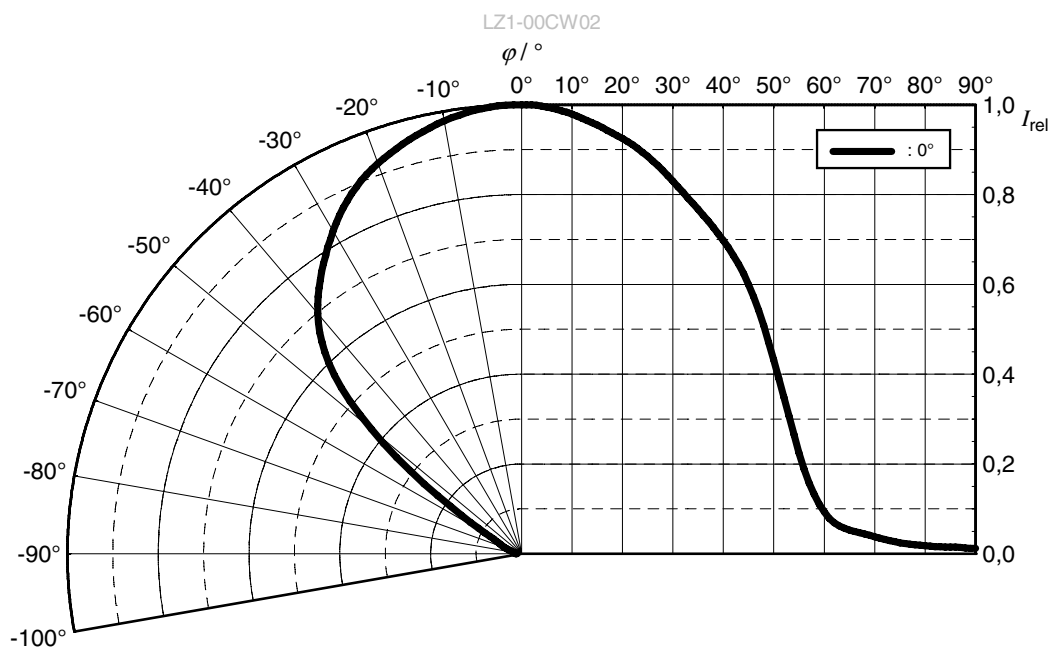

Forward current ⁵⁾

$$I_F = f(V_F); T_C = 25\text{ °C}$$

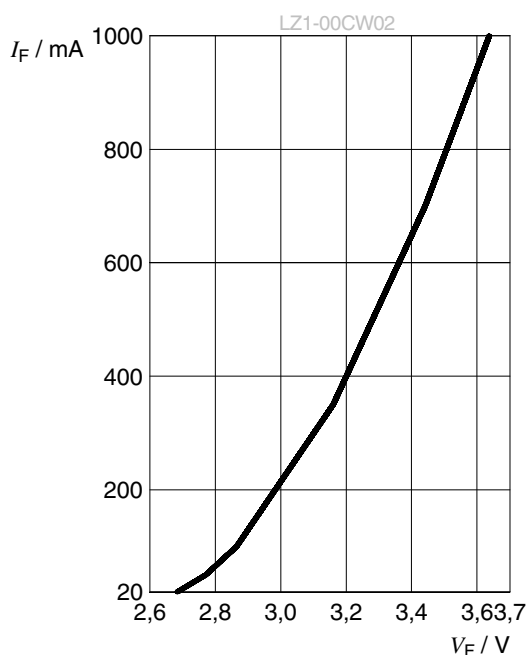

Relative Luminous Flux ^{5), 8)}

$$\Phi_V / \Phi_V(1000\text{ mA}) = f(I_F); T_C = 25\text{ °C}$$

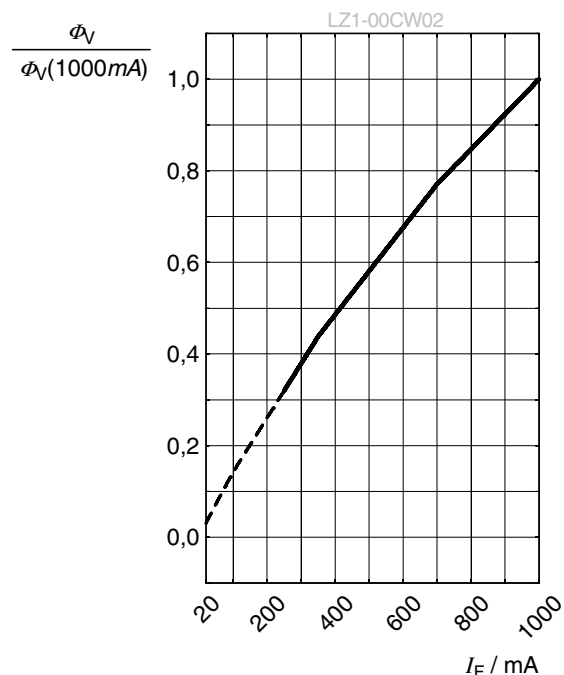

Chromaticity Coordinate Shift ⁵⁾

$$\Delta C_x, \Delta C_y = f(I_F); T_C = 25\text{ °C}$$

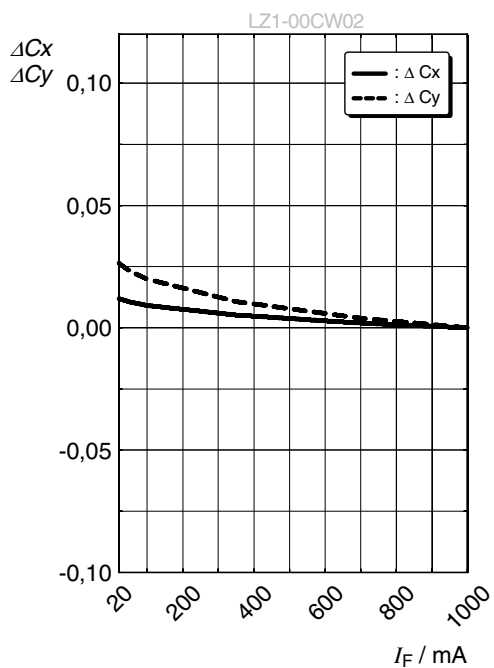

Forward Voltage ⁵⁾

$$\Delta V_F = V_F - V_F(25\text{ °C}) = f(T_j); I_F = 1000\text{ mA}$$

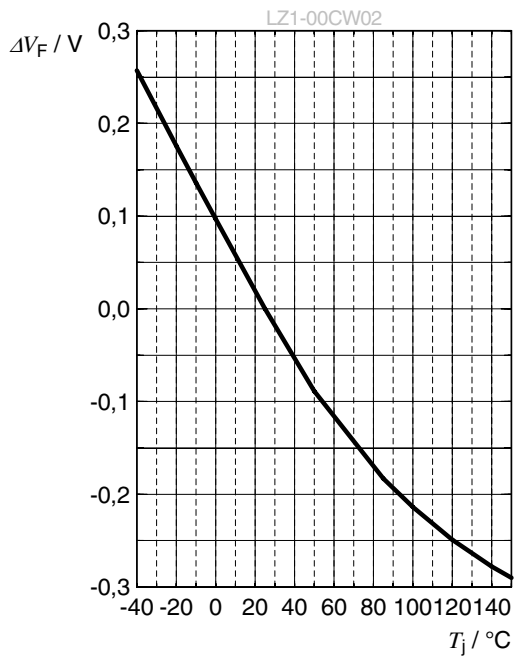

Relative Luminous Flux ⁵⁾

$$\Phi_V / \Phi_V(25\text{ °C}) = f(T_j); I_F = 1000\text{ mA}$$

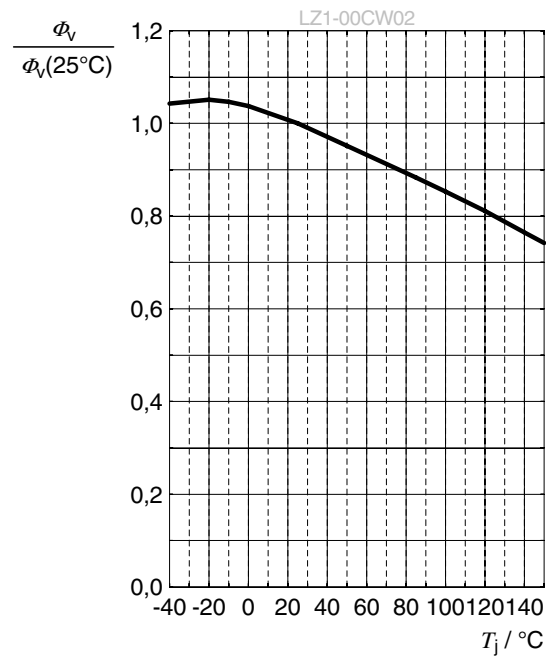

Chromaticity Coordinate Shift ⁵⁾

$$\Delta C_x, \Delta C_y = f(T_j); I_F = 1000\text{ mA}$$

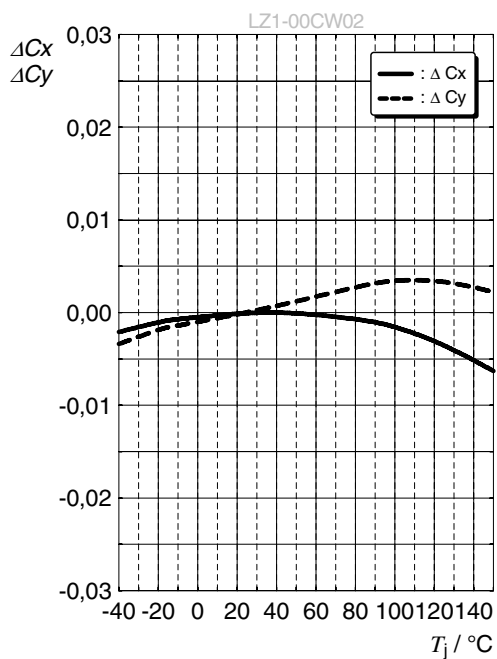

Max. Permissible Forward Current ⁹⁾

$$I_F = f(T)$$

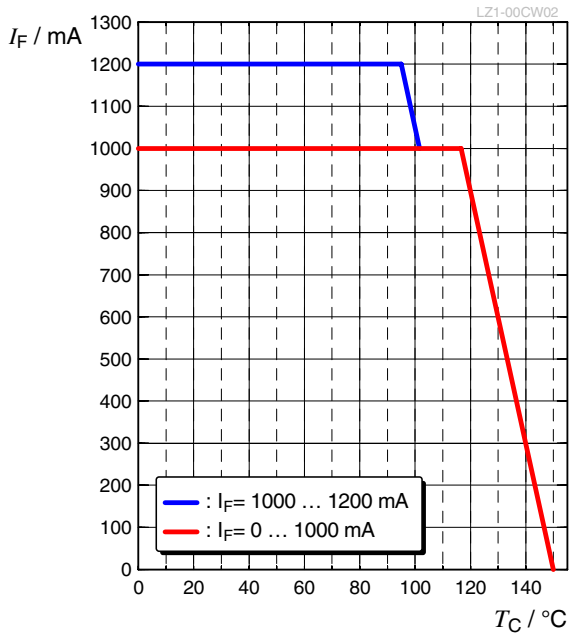

Dimensional Drawing ¹⁰⁾

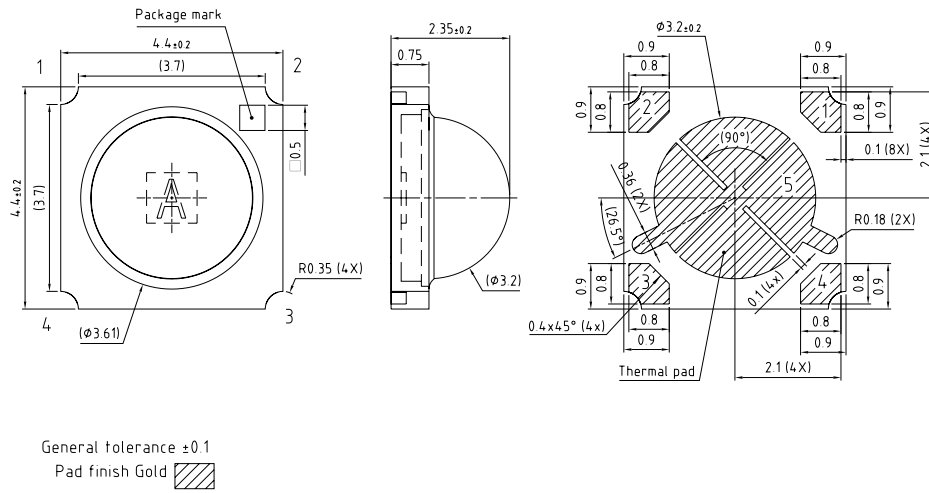

C67062-A0370-A1.-03

Further Information:

Approximate Weight: 93.9 mg

Electrical Internal Circuit

Pin Out	
Pad	Function
1	Anode
2	Cathode
3	Cathode
4	Anode
5	Thermal

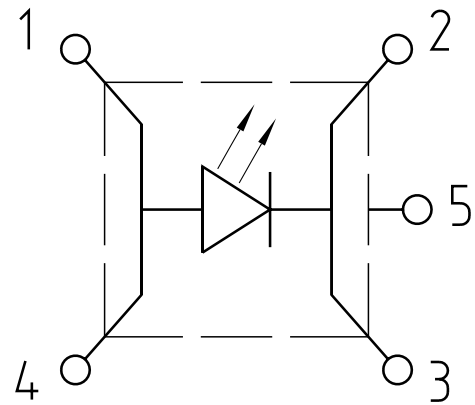

Recommended Solder Pad ¹⁰⁾

Non-pedestal MCPCB Design

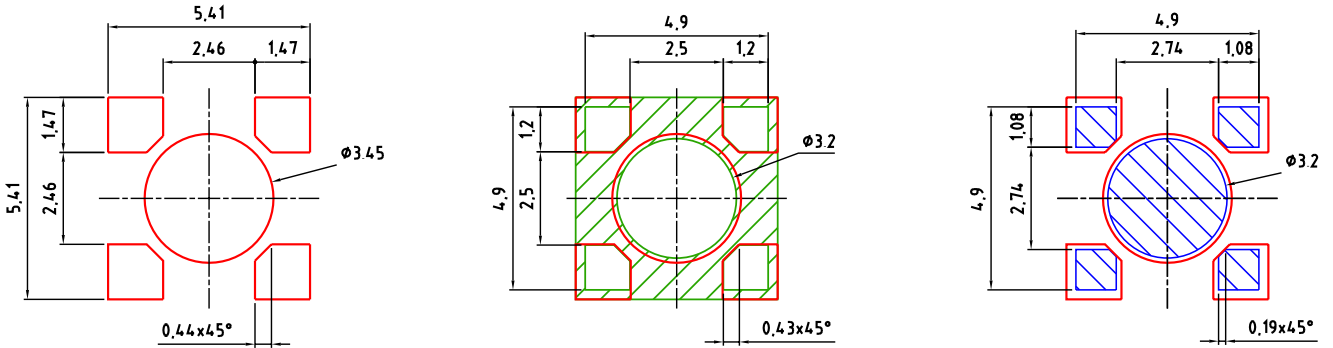

Pedestal MCPCB Design

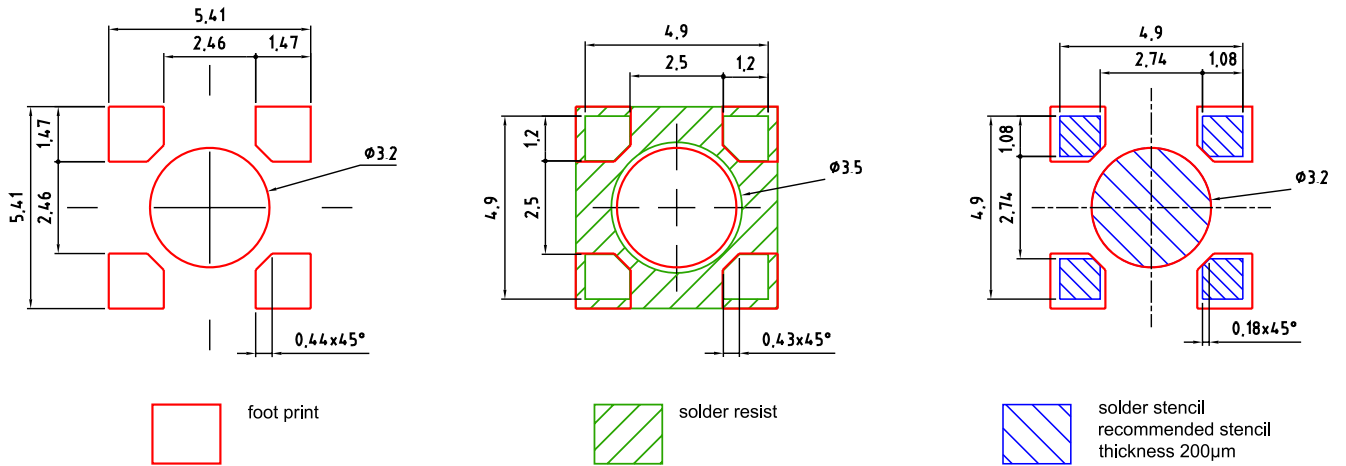

Component Location on Pad

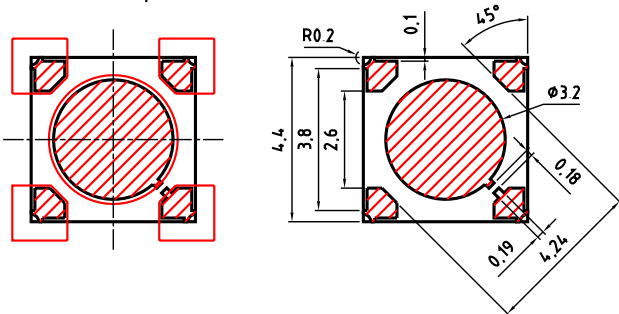

E062.3010.296-01

1. For superior solder joint connectivity results we recommend soldering under standard nitrogen atmosphere.
2. Package not suitable for ultra sonic cleaning.
3. Pedestal MCPCB allows the emitter thermal slug to be soldered directly to the metal core of the MCPCB. Such MCPCB eliminate the high thermal resistance dielectric layer that standard MCPCB technologies use in between the emitter thermal slug and the metal core of the MCPCB, thus lowering the overall system thermal resistance.
4. X-ray sample monitoring for solder voids underneath the emitter thermal slug is recommended. The total area covered by solder voids should be less than 20% of the total emitter thermal slug area. Excessive solder voids will increase the emitter to MCPCB thermal resistance and may lead to higher failure rates due to thermal over stress.

Reflow Soldering Profile

Product complies to MSL Level 1 acc. to JEDEC J-STD-020E

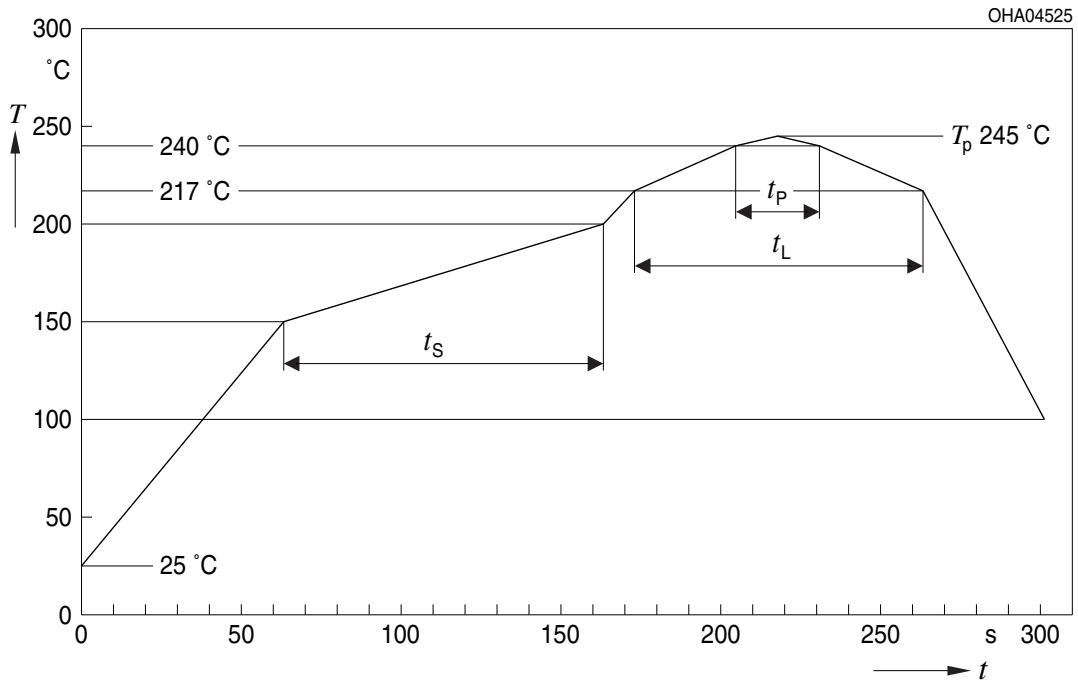

Profile Feature	Symbol	Pb-Free (SnAgCu) Assembly			Unit
		Minimum	Recommendation	Maximum	
Ramp-up rate to preheat ^{*)} 25 °C to 150 °C			2	3	K/s
Time t_s T_{Smin} to T_{Smax}	t_s	60	100	120	s
Ramp-up rate to peak ^{*)} T_{Smax} to T_p			2	3	K/s
Liquidus temperature	T_L		217		°C
Time above liquidus temperature	t_L		80	100	s
Peak temperature	T_p		245	260	°C
Time within 5 °C of the specified peak temperature $T_p - 5$ K	t_p	10	20	30	s
Ramp-down rate* T_p to 100 °C			3	6	K/s
Time 25 °C to T_p				480	s

All temperatures refer to the center of the package, measured on the top of the component
^{*)} slope calculation DT/Dt : Dt max. 5 s; fulfillment for the whole T-range

Taping ¹⁰⁾

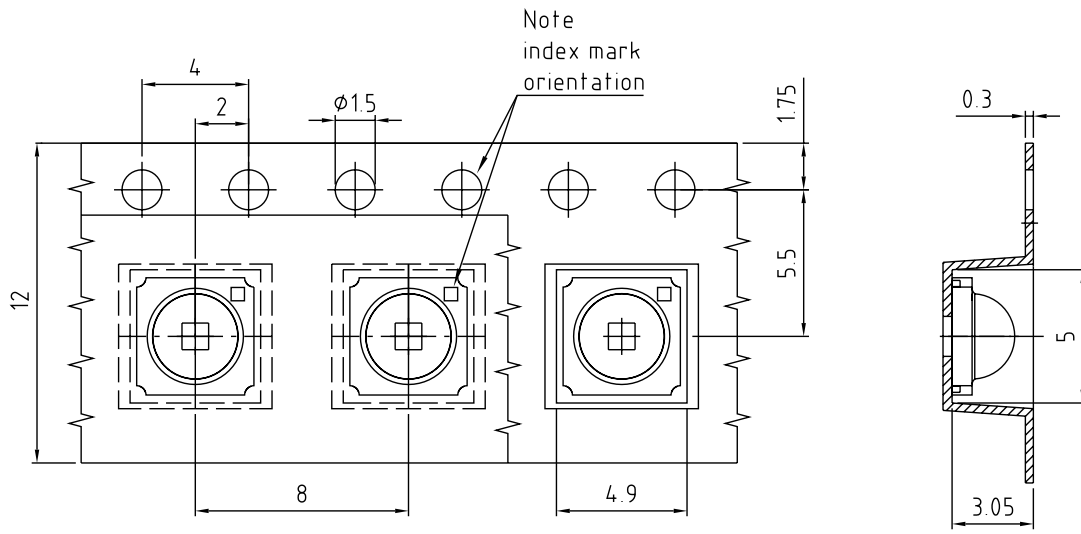

C67062-A0370-B1-01

Tape and Reel ¹¹⁾

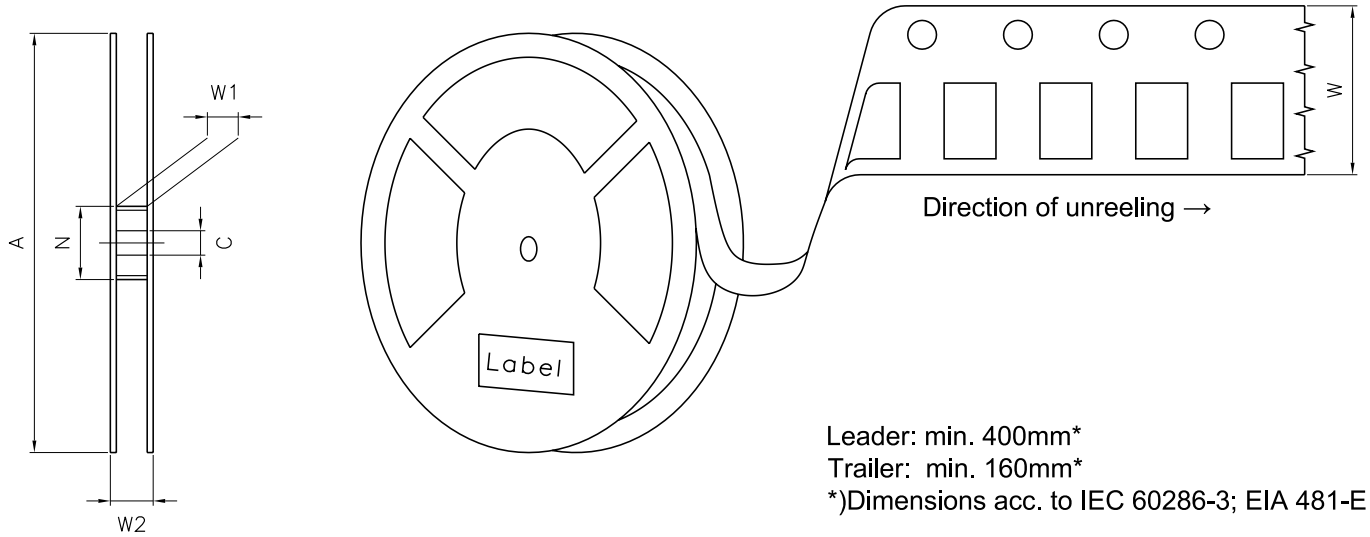

Reel Dimensions

A	W	N _{min}	W ₁	W _{2max}	Pieces per PU
180 mm	12 + 0.3 / - 0.1 mm	60 mm	12.4 + 2 mm	18.4 mm	500

Barcode-Product-Label (BPL)

OSRAM
Opto Semiconductors
Our Brand 
LED ENGINE



(6P) Batch No: 1234567890
(1T) Lot No: 1234567890
(X) Prod No: 12345678
(9D) D/C : 1234
(Q) Qty: 9999
CoO: XX

LXX-XXXXX
XxxXxx
RoHS Compliant

BIN1: XXX-X-X-XXX
BIN2: XXX-X-X-XXX
BIN3: XX-X-X-XXX
BIN4: XXX-XXX-X-XXX
BIN5: X-XX-X-XXX
BIN6: X-XX-X-XXX

ML TEMP ST
X XXX° X

Pack: RXX
B_X123_12345.1234
001



Notes

The evaluation of eye safety occurs according to the standard IEC 62471:2006 (photo biological safety of lamps and lamp systems). Within the risk grouping system of this IEC standard, the device specified in this data sheet fall into the class **moderate risk (exposure time 0.25 s)**. Under real circumstances (for exposure time, conditions of the eye pupils, observation distance), it is assumed that no endangerment to the eye exists from these devices. As a matter of principle, however, it should be mentioned that intense light sources have a high secondary exposure potential due to their blinding effect. When looking at bright light sources (e.g. headlights), temporary reduction in visual acuity and afterimages can occur, leading to irritation, annoyance, visual impairment, and even accidents, depending on the situation.

Subcomponents of this device contain, in addition to other substances, metal filled materials including silver. Metal filled materials can be affected by environments that contain traces of aggressive substances. Therefore, we recommend that customers minimize device exposure to aggressive substances during storage, production, and use. Devices that showed visible discoloration when tested using the described tests above did show no performance deviations within failure limits during the stated test duration. Respective failure limits are described in the IEC60810.

Tapes and reels are shipped in airtight bags in order to reduce the onset of silver tarnish. We recommend bags only be opened when ready to use emitters. Partially used reels or trays should be stored in airtight bags or in storage purged with nitrogen.

Based on very short life cycle times in chip technology this component is subject to frequent adaption to the latest chip technology.

Changes to the content of this datasheet may occur without further notification. JEDEC 46C constitutes the guideline of the change management for the device specified in this document.

For further application related information please visit <https://ams-osram.com/support/application-notes>

Disclaimer

Attention please!

The information describes the type of component and shall not be considered as assured characteristics. Terms of delivery and rights to change design reserved. Due to technical requirements components may contain dangerous substances.

For information on the types in question please contact our Sales Organization.

If printed or downloaded, please find the latest version on our website.

Packing

Please use the recycling operators known to you. We can also help you – get in touch with your nearest sales office. By agreement we will take packing material back, if it is sorted. You must bear the costs of transport. For packing material that is returned to us unsorted or which we are not obliged to accept, we shall have to invoice you for any costs incurred.

Product and functional safety devices/applications or medical devices/applications

Our components are not developed, constructed or tested for the application as safety relevant component or for the application in medical devices.

Our products are not qualified at module and system level for such application.

In case buyer – or customer supplied by buyer – considers using our components in product safety devices/ applications or medical devices/applications, buyer and/or customer has to inform our local sales partner immediately and we and buyer and /or customer will analyze and coordinate the customer-specific request between us and buyer and/or customer.

Glossary

- 1) **Brightness:** Brightness groups are tested at a current pulse duration of 10 ms and a tolerance of $\pm 10\%$.
- 2) **Operating Conditions:** Operating conditions according DC-derating (Max. Permissible Forward Current)
- 3) **Reverse Operation:** Not designed for reverse operation. Continuous reverse operation can cause migration and damage of the device.
- 4) **Chromaticity coordinate groups:** Chromaticity coordinate groups are tested at a current pulse duration of 10 ms and a tolerance of ± 0.01 .
- 5) **Typical Values:** Due to the special conditions of the manufacturing processes of semiconductor devices, the typical data or calculated correlations of technical parameters can only reflect statistical figures. These do not necessarily correspond to the actual parameters of each single product, which could differ from the typical data and calculated correlations or the typical characteristic line. If requested, e.g. because of technical improvements, these typ. data will be changed without any further notice.
- 6) **Forward Voltage:** Forward voltages are tested at a current pulse duration of 10 ms and a tolerance of ± 0.1 V.
- 7) **Color reproduction index:** Color reproduction index values (CRI-RA) are measured during a current pulse of typically 25 ms, with an internal reproducibility of ± 2 and an expanded uncertainty of ± 3 (acc. to GUM with a coverage factor of $k = 3$).
- 8) **Characteristic curve:** In the range where the line of the graph is broken, you must expect higher differences between single devices within one packing unit.
- 9) **Thermal Resistance:** $R_{th\ max}$ is based on statistic values (6σ) used for Derating.
- 10) **Tolerance of Measure:** Unless otherwise noted in drawing, tolerances are specified with ± 0.1 and dimensions are specified in mm.
- 11) **Tape and Reel:** All dimensions and tolerances are specified acc. IEC 60286-3 and specified in mm.

Revision History

Version	Date	Change
1.6	2021-04-30	New Layout
1.7	2023-11-07	New Layout Applications Dimensional Drawing



EU RoHS and China RoHS compliant product

此产品符合欧盟 RoHS 指令的要求；
按照中国的相关法规和标准，
不含有毒有害物质或元素。

Published by ams-OSRAM AG

Tobelbader Strasse 30, 8141 Premstaetten, Austria

Phone +43 3136 500-0

ams-osram.com

© All rights reserved

am 

OSRAM

Mouser Electronics

Authorized Distributor

Click to View Pricing, Inventory, Delivery & Lifecycle Information:

[ams OSRAM:](#)





[LZ1-00CW02-0055](#) [LZ1-00CW02-0065](#)

Looking for pricing, stock, or lifecycle information?

Click below to explore more details on WIN SOURCE:

-  [View LZ1-00CW02-0055 on WIN SOURCE](#)
-  [OSRAM Opto Semiconductors Inc. Information](#)

Optimize Your Supply Chain with WIN SOURCE Solutions

-  Global Sourcing Solution
-  Obsolete Management
-  Cost Control Management
-  Shortage Management
-  Alternative Solution
-  Excess Inventory Management