



## Overview

**KO-CAP** Polymer Capacitors

The KEMET Organic Capacitor (KO-CAP) is a solid electrolytic capacitor with a conductive polymer cathode capable of delivering very low ESR and improved capacitance retention at high frequencies. KO-CAP combines the low ESR of multilayer ceramic, the high capacitance of aluminum electrolytic, and the volumetric efficiency of tantalum into a single surface mount package. Unlike liquid electrolyte-based capacitors, KO-CAP has a very long operational life and high ripple current capabilities.

The T52X/T530 provides the widest range of voltages, capacitance and case size options in the KO-CAP family and is suitable for general purpose DC applications for up to 48 VDC voltage rails.

## Benefits

- ESR values down to 4 mΩ
- Stable capacitance across temperature and voltage
- No aging effects
- High ripple handling
- Volumetrically efficient
- High frequency capacitance retention
- 100% accelerated steady state aging
- 100% surge current tested

## Applications

Typical applications include DC/DC converters, audio/sound circuits (mobile phone and base stations, smart phones, MP3 players), power supply inputs, portable electronics (notebook PCs, displays, SSDs, HDDs and USBs, digital cameras, GPS navigation systems, WiFi modules), telecommunications, consumer electronics (analytical and test equipment, high speed servers), high voltage applications such as 12 V to 48 V power input rails, densely populated circuits with space restrictions, microprocessor decoupling, and high ripple current applications.

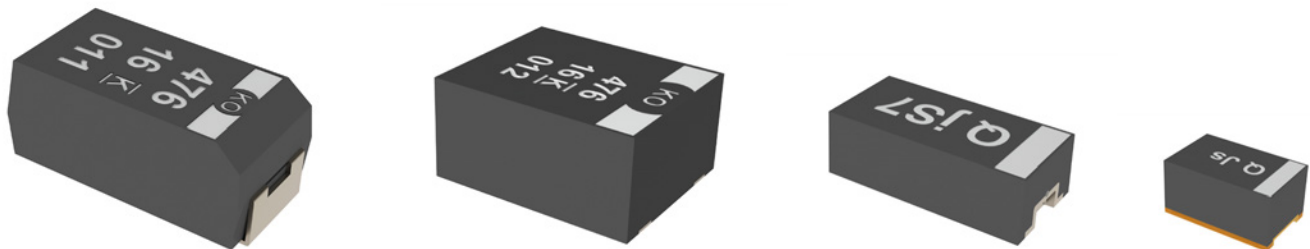

## Environmental Compliance

- RoHS compliant when ordered with 100% Sn, Ni-Pd-Au or non-magnetic 100% Sn solder
- Halogen-free
- Epoxy compliant with UL94 V-0\*<sup>1</sup>

\*<sup>1</sup>: Except part numbers in the T529 series, please refer to the Table 1

## K-SIM

For a detailed analysis of specific part numbers, please visit <https://ksim.kemet.com/capacitor-simulation> to access KEMET's K-SIM software. KEMET K-SIM is designed to simulate behavior of components with respect to frequency, ambient temperature, and DC bias levels.

## Series Reference Selection

Series		Voltage Range		Maximum Operating Temperature			Special Features		
		< 1 V to 9 V Applications	12 V to 48 V Applications	85°C Rated	105°C Rated	125°C Rated	Miniature Size	Low ESL	Low DC Leakage
T520	Standard	X	*	X**	X				
T521	High Voltage		X		X	X			X
T523	Facedown Terminal	X	X**	X	X**			X	
T525	High Temperature	X	*			X			
T527	Small Size	X	X		X		X		
T529	Miniature	X	X		X		X		
T530	High Cap/ Low ESR	X	X			X			
TF08	Ultrathin-Facedown	X	*		X		X		

\* Not recommended for new design.

\*\* Selected values.

## Ordering Information

### T52X/T530

T	520	V	157	M	006	A	T	E045	
Capacitor Class	Series	Case Size <sup>1</sup>	Capacitance Code (pF)	Capacitance Tolerance	Rated Voltage (VDC)	Failure Rate/Design	Termination Finish	ESR & DC Leakage Code	Packaging (C-Spec)
T = Tantalum	520 = Polymer 521 = High voltage 523 = Facedown terminal 525 = 125°C rated 527 = Facedown terminal 529 = Substrate terminal 530 = 125°C High capacitance	A B C D H I J K L M P Q S T U V W X Y	First two digits represent significant figures. Third digit specifies number of zeros.	K = ±10% M = ±20%	002 = 2 2R5 = 2.5 003 = 3 004 = 4 006 = 6.3 008 = 8 010 = 10 011 = 11 12R = 12.5 016 = 16 020 = 20 025 = 25 035 = 35 050 = 50 063 = 63 075 = 75	A = N/A	T = 100% Matte tin (Sn)-plated H*** = Tin/lead (SnPb) solder coated (5% Pb minimum) P* = Ni-Pd-Au-plated A** = Ni-Au	E = ESR last three digits specify ESR in mΩ. (045 = 45 mΩ). DC Leakage max 0.1 CV  K = ESR last three digits specify ESR in mΩ. DC Leakage max 0.05 CV  I = ESR last three digits specify ESR in mΩ. DC Leakage max 0.03 CV	Blank = 7" reel 7280**** = 13" reel

Gold termination available upon request

Non-magnetic terminations available for customized solutions. For availability and technical information, please contact your KEMET sales representative.

\* P termination only available on select part numbers

\*\* A termination only available on T529 part numbers

\*\*\* H termination not available for T527/T529 part numbers

\*\*\*\* 13" reel not available for T520A case and some other part numbers

## Ordering Information cont.

### TF08

T	F	08A	226	M	016	A	P	E200
Capacitor Class	Series	Case Size	Capacitance Code (pF)	Capacitance Tolerance	Rated Voltage (VDC)	Failure Rate/Design	Termination Finish	ESR Code
T = Tantalum	F= Ultrathin polymer solution-Facedown construction	08A = 3216/0.8 max height	First two digits represent significant figures. Third digit specifies number of zeros.	M = ±20%	006 = 6.3 016 = 16	A = N/A	P = Ni-Pd-Au-plated	E = ESR Last three digits specify ESR in mΩ (200 = 200mΩ)

## Performance Characteristics

Item	Performance Characteristics
Operating Temperature	-55°C to 85°C/105°C/125°C (refer to part number for maximum temperature rating)
Rated Capacitance Range	0.68 – 1,500 µF at 120 Hz/25°C *
Capacitance Tolerance	K tolerance (10%), M tolerance (20%)
Rated Voltage Range	2 – 75 V
DF (120 Hz)	Refer to Part Number Electrical Specification Table*
ESR (100 kHz)	Refer to Part Number Electrical Specification Table**
Leakage Current	Refer to Part Number Electrical Specification Table

\* For parts identified with ^ symbol in the part numbers table, apply 1.5 V DC for measurement

\*\* For PN T520B477M2R5ATE014 the ESR measurement should be taken at 300 to 500kHz

## Qualification

Test	Condition	Characteristics	
Endurance	Temperature: 85°C, 105°C <sup>*2</sup> Voltage: 1.0 Rated Voltage Time: 2,000 Hours <sup>*5</sup>	Δ C/C	Within -20%/+10% of initial value or ±20 <sup>*1</sup>
		DF	Within initial limits or 1.5 x initial limit <sup>*1</sup>
		DCL	Within 1.25 x initial limit for T ≤ 105°C Within 2.0 x initial limit for > 105°C Within initial limit <sup>*1</sup> TF08A: Within 1.5 x initial limit
		ESR	Within 2.0 x initial limit or N/A <sup>*1</sup>
Endurance	Temperature: 125°C <sup>*2</sup> Voltage: 2/3 rated voltage 0.8 rated voltage (for parts with derate category 7) Time: 2,000 hours	Δ C/C	Within -20/+10 of initial value
		DF	Within initial limit
		DCL	Within 2.0 x initial limit
		ESR	Within 2.0 x initial limit
Storage Life	Temperature: 105°C, 125°C <sup>*2</sup> Voltage: 0 Voltage Time: 2,000 Hours (This test is N/A for <sup>*1</sup> )	Δ C/C	Within -20%/+10% of initial value
		DF	Within initial limits
		DCL	Within 1.25 x initial limit T521: 1.25 x IL at 105°C, 2x IL at 125°C T525/T530: Within 2.0 x initial limit
		ESR	Within 2.0 x initial limit

<sup>\*1</sup> For case code 3528-21 and lower identified with ^ at the part number table (except the T520A, T527T226M025ATE100)

<sup>\*2</sup> Please refer to part number specifications for individual temperature classification.

<sup>\*3</sup> IL = Initial limit

<sup>\*4</sup> For T527/T529 > 20 V test temperature is at + 15 to +35°C, test voltage at 1.16 x V<sub>R</sub> (except T527T226M025ATE100 test temperature is +105°C)

For T527/T529/TF, 6 V test voltage is 1.27 x rated voltage

For TFA08226M016 test voltage is 1.15 x rated voltage

<sup>\*5</sup> Test time is 1,000 hours for the below:

Parts with case code 3528-21 and lower identified with ^ at the part number table (except the T520A part numbers T527T156M025ATE100, T527T226M025ATE100 and T521B156M025ATE090)

<sup>\*6</sup> +85°C measurement is applicable to: T527T226M025ATE100

<sup>\*7</sup> Delta cap condition of +50/ 0% is applicable to: T527T226M025APE100

<sup>\*8</sup> DF at 1.5 X IL is applicable to: T527T226M025APE100

## Qualification cont.

Humidity	Temperature: 60°C Voltage: No Load Humidity: 90% RH Time: 500 Hours, 1,000 Hours (T525, T530)	Δ C/C	Within -5%/+35% of initial value or -20%, +30% of initial DC/C limit <sup>*1</sup> T520B477M2R5ATE014: -20% to +50% of initial DC/C limit			
		DF	Within initial limits T527/T529/TF08A: Within 1.5 x initial limits <sup>*3</sup>			
		DCL	Within 5.0 x initial limit T521/T525/T529/T530: Within 3.0 x initial limit <sup>*3</sup> T527/TF08A: Within initial limits			
		ESR	Within 2.0 x initial limit T525/T527/T529/T530/TF08A: N/A <sup>*3</sup>			
Temperature Stability	Extreme temperature exposure at a succession of continuous steps at +25°C, -55°C, +25°C, +85°C, +105°/125°C <sup>*2</sup> , +25°C		+25°C	-55°C	+85°C (N/A T527/T529/ TF08A) <sup>*6</sup>	+105°C
		Δ C/C	IL <sup>*3</sup>	±20% 0% to -20% of DC/C <sup>*1</sup>	±20% +50% to 0% of DC/C <sup>*7</sup>	±30% +50% to 0% of DC/C <sup>*1*7</sup>
		DF	IL	IL	1.2 x IL 1.5 x IL <sup>*8</sup>	1.5 x IL
		DCL	IL	N/A	10 x IL	10 x IL
Surge Voltage	Temperature: 105°C, 85°C <sup>*1,*2,*4</sup> Voltage: 1.32 x Rated voltage <sup>*4</sup> 1.0 x Rated voltage <sup>*1</sup> Time: 1,000 cycles	Δ C/C	Within -20%/+10% of initial value or ±20% <sup>*1</sup>			
		DF	Within initial limits			
		DCL	Within initial limits			
		ESR	Within initial limits or N/A <sup>*1</sup>			
Mechanical Shock/Vibration	MIL-STD-202, Method 213, Condition I, 100 G Peak.  MIL-STD-202, Method 204, Condition D, 10 Hz to 2,000 Hz, 20 G peak	Δ C/C	Within ±10% of initial value or initial DC/C limits <sup>*1</sup>			
		DF	Within initial limits			
		DCL	Within initial limits			

<sup>\*1</sup> For case code 3528-21 and lower identified with ^ at the part number table (except the T520A, T527T226M025ATE100)

<sup>\*2</sup> Please refer to part number specifications for individual temperature classification.

<sup>\*3</sup> IL = Initial limit

<sup>\*4</sup> For T527/T529 > 20 V test temperature is at + 15 to +35°C, test voltage at 1.16 x V<sub>R</sub> (except T527T226M025ATE100 test temperature is +105°C)

For T527/T529/TF, 6 V test voltage is 1.27 x rated voltage

For TFA08226M016 test voltage is 1.15 x rated voltage

<sup>\*5</sup> Test time is 1,000 hours for the below:

Parts with case code 3528-21 and lower identified with ^ at the part number table (except the T520A part numbers T527T156M025ATE100, T527T226M025ATE100 and T521B156M025ATE090)

<sup>\*6</sup> +85°C measurement is applicable to: T527T226M025ATE100

<sup>\*7</sup> Delta cap condition of +50/ 0% is applicable to: T527T226M025APE100

<sup>\*8</sup> DF at 1.5 X IL is applicable to: T527T226M025APE100

## Reliability

KO-CAP capacitors have an average failure rate of 0.5 %/1,000 hours at category voltage,  $U_C$ , and category temperature,  $T_C$ . These capacitors are qualified using industry test standards at  $U_C$  and  $T_C$ . The minimum test time (1,000 hours or 2,000 hours) is dependent on the product.

The actual life expectancy of KO-CAP capacitors increases when application voltage,  $U_A$ , and application temperature,  $T_A$ , are lower than  $U_C$  and  $T_C$ . As a general guideline, when  $U_A < 0.9 * U_C$  and  $T_A < 85^\circ\text{C}$ , the life expectancy will typically exceed the useful lifetime of most hardware (> 10 years).

The lifetime of a KO-CAP capacitor at a specific application voltage and temperature can be modeled using the equations below. A failure is defined as passing enough current to blow a 1-amp fuse. The calculation is an estimation based on empirical results and is not a guarantee.

$$VAF = \left(\frac{U_C}{U_A}\right)^n$$

where:  
 VAF = acceleration factor due to voltage, unitless  
 $U_C$  = category voltage, volt  
 $U_A$  = application voltage, volt  
 n = exponent, 16

$$TAF = e^{\left[\frac{E_a}{k} \left(\frac{1}{273+T_A} - \frac{1}{273+T_C}\right)\right]}$$

where:  
 TAF = acceleration factor due to temperature, unitless  
 $E_a$  = activation energy, 1.4 eV  
 k = Boltzmann's constant, 8.617E-5 eV/K  
 $T_A$  = application temperature, °C  
 $T_C$  = category temperature, °C

$$AF = VAF * TAF$$

where:  
 AF = acceleration factor, unitless  
 TAF = acceleration factor due to temperature, unitless  
 VAF = acceleration factor due to voltage, unitless

$$Life_{U_A, T_A} = Life_{U_C, T_C} * AF$$

where:  
 $Life_{U_A, T_A}$  = estimated life application voltage and temperature, years  
 $Life_{U_C, T_C}$  = guaranteed life category voltage and temperature, years  
 AF = acceleration factor, unitless

**Terms:**

Category voltage,  $U_C$ : maximum recommended peak DC operating voltage for continuous operation at the category temperature,  $T_C$   
 Rated voltage,  $U_R$ : maximum recommended peak DC operating voltage for continuous operation up to the rated temperature,  $T_R$   
 Category temperature,  $T_C$ : maximum recommended operating temperature. Voltage derating may be required at  $T_C$   
 Rated temperature,  $T_R$ : maximum recommended operating temperature without voltage derating.  $T_R$  is equal to or lower than  $T_C$

Reliability Table 1 – Common temperature range classifications														
85°C ( $T_R$ ) / 85°C ( $T_C$ )	Rated Voltage ( $U_R$ )	2.5	4.0	6.3	8.0	10.0	12.5	16.0	20.0	25.0	35.0	50.0	63.0	75.0
	Category Voltage ( $U_C$ )	2.5	4.0	6.3	8.0	10.0	12.5	16.0	20.0	25.0	35.0	50.0	63.0	75.0
105°C ( $T_R$ ) / 105°C ( $T_C$ )	Rated Voltage ( $U_R$ )	2.5	4.0	6.3	8.0	10.0	12.5	16.0	20.0	25.0	35.0	50.0	63.0	75.0
	Category Voltage ( $U_C$ )	2.5	4.0	6.3	8.0	10.0	12.5	16.0	20.0	25.0	35.0	50.0	63.0	75.0
105°C ( $T_R$ ) / 125°C ( $T_C$ )	Rated Voltage ( $U_R$ )	2.5	4.0	6.3	8.0	10.0	12.5	16.0	20.0	25.0	35.0	50.0	63.0	75.0
	Category Voltage ( $U_C$ )	1.7	2.7	4.2	5.4	6.7	8.4	10.7	13.4	16.8	23.5	33.5	42.2	50.3

## Electrical Characteristics

### T520 Standard (2 V – 10 V)

ESR vs. Frequency

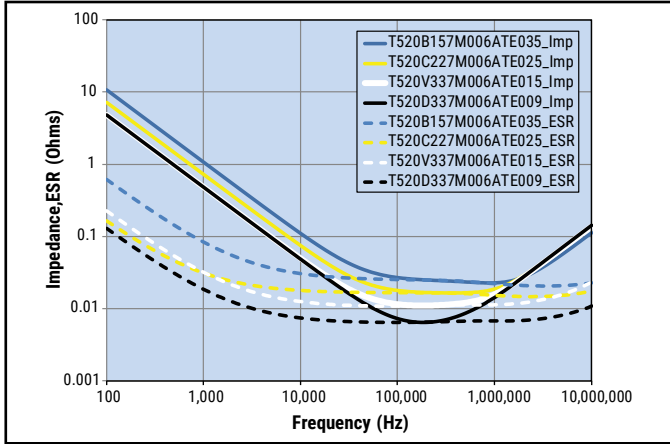

Capacitance vs. Frequency

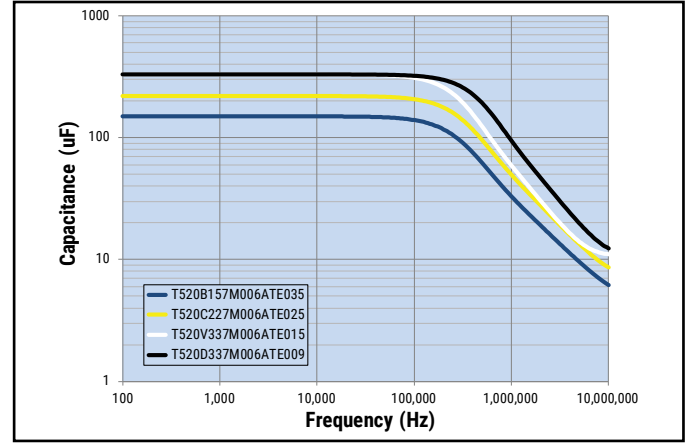

### T521 High Voltage (12 V – 75 V)

ESR vs. Frequency

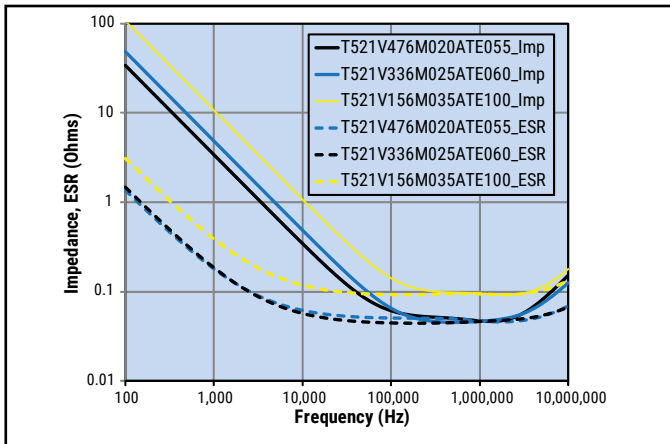

Capacitance vs. Frequency

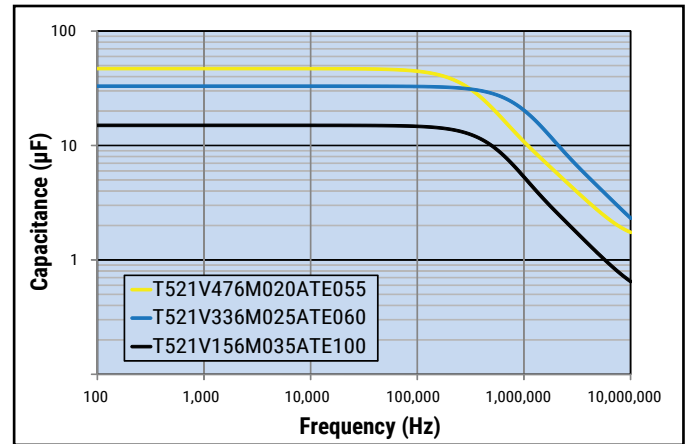

### T530 High Cap/Low ESR (2 V – 10 V)

ESR vs. Frequency

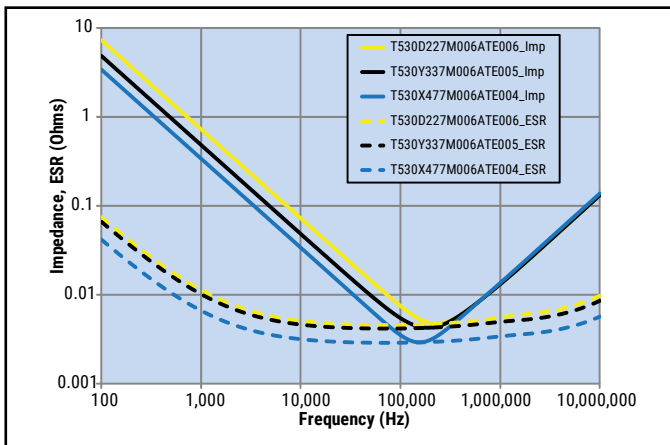

Capacitance vs. Frequency

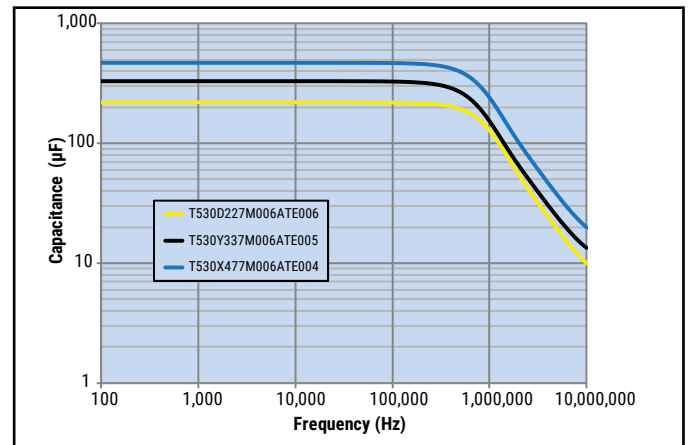

## Dimensions – Millimeters (Inches)

Metric will govern

### T520 / T521 / T525 / T530

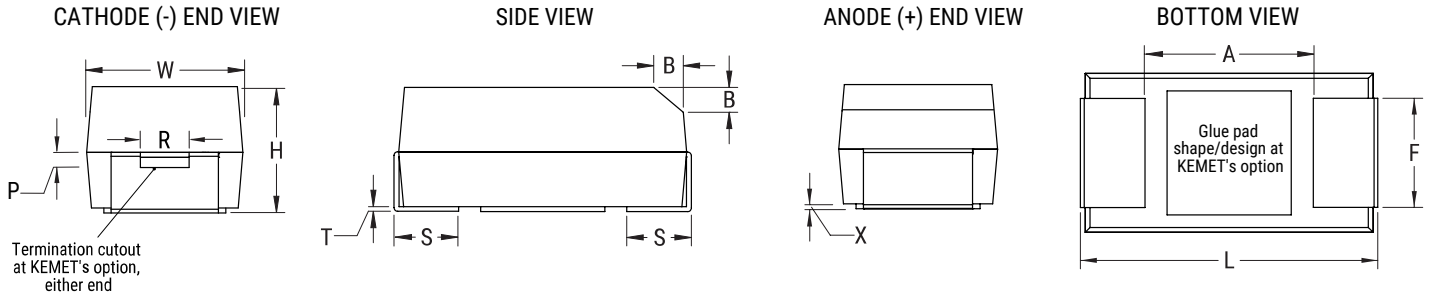

Case Size		Component Dimensions											Typical Weight (mg)
KEMET	EIA	L	W	H	F ±0.1 ±(0.004)	S ±0.3 ±(0.012) S1 ±0.4 (0.0157) S2 ±0.2 (0.00)	B ±0.15 (Ref) ±0.006	X (Ref)	P (Ref)	R (Ref)	T (Ref)	A (Min)	
A	3216-18	3.2 ±0.2 (0.126 ±0.008)	1.6 ±0.2 (0.063 ±0.008)	1.6 ±0.2 (0.063 ±0.008)	1.2 (0.047)	0.8 (0.032)	N/A	0.10 ±0.10 (0.004 ±0.004)	0.4 (0.016)	0.4 (0.016)	0.13 (0.005)	1.2 (0.047)	53
B	3528-21	3.5 ±0.2 (0.138 ±0.008)	2.8 ±0.2 (0.110 ±0.008)	1.9 ±0.1 <sup>*3</sup> (0.075 ±0.004)	2.2 (0.087)	0.8 (0.032) S1 = 0.8 (0.032) <sup>*2</sup> S2 = 0.8 (0.032) <sup>*2</sup>	0.4 (0.016)	0.10 ±0.10 (0.004 ±0.004)	0.5 (0.020)	1.0 (0.039)	0.13 (0.005)	1.9 (0.075)	95
C	6032-28	6.0 ±0.3 (0.236 ±0.012)	3.2 ±0.2 (0.126 ±0.008)	2.5 ±0.3 (0.098 ±0.012)	2.2 (0.087)	1.30 (0.051)	0.5 (0.020)	0.10 ±0.10 (0.004 ±0.004)	0.9 (0.035)	1.0 (0.039)	0.13 (0.005)	2.9 (0.114)	184
D	7343-31	7.3 ±0.3 (0.287 ±0.012)	4.3 ±0.3 (0.169 ±0.012)	2.8 ±0.3 (0.110 ±0.012)	2.4 (0.094)	1.30 (0.051)	0.5 (0.020)	0.10 ±0.10 (0.004 ±0.004)	0.9 (0.035)	1.0 (0.039)	0.13 (0.005)	3.8 (0.150)	435
H	7360-20	7.3 ±0.3 (0.287 ±0.012)	6.0 ±0.3 (0.236 ±0.012)	1.9 ±0.1 (0.075 ±0.004)	4.1 (0.161)	1.3 (0.051)	N/A	0.10 ±0.10 (0.004 ±0.004)	N/A	N/A	0.13 (0.005)	3.3 (0.130)	385
J	7360-15	7.3 ±0.3 (0.287 ±0.012)	6.0 ±0.3 (0.236 ±0.012)	1.5 (0.059) Maximum	4.1 (0.161)	1.3 (0.051)	N/A	0.10 ±0.10 (0.004 ±0.004)	N/A	N/A	N/A	3.3 (0.130)	263
L	6032-19	6.0 ±0.3 (0.236 ±0.012)	3.2 ±0.2 (0.126 ±0.008)	1.8 ±0.1 (0.071 ±0.004)	2.2 (0.087)	1.3 (0.051)	N/A	0.05 (0.002)	N/A	N/A	0.13 (0.005)	2.5 (0.098)	187
M	3528-15	3.5 ±0.2 (0.138 ±0.008)	2.8 ±0.2 (0.110 ±0.008)	1.4 ±0.1 (0.055 ±0.004)	2.2 (0.087)	0.8 (0.031)	N/A	0.05 (0.002)	N/A	N/A	0.13 (0.005)	1.1 (0.043)	98
Q	7343-12	7.3 ±0.3 (0.287 ±0.012)	4.3 ±0.3 (0.169 ±0.012)	1.1 ±0.1 (0.043 ±0.004)	2.4 (0.094)	1.3 (0.051)	N/A	0.05 (0.002)	N/A	N/A	0.13 (0.005)	3.8 (0.150)	170
T	3528-12	3.5 ±0.2 (0.138 ±0.008)	2.8 ±0.2 (0.110 ±0.008)	1.1 ±0.1 (0.043 ±0.004)	2.2 (0.087)	0.8 (0.031)	N/A	0.05 (0.002)	N/A	N/A	0.13 (0.005)	1.9 (0.075)	55
U	6032-15	6.0 ±0.3 (0.236 ±0.012)	3.2 ±0.2 (0.126 ±0.008)	1.4 ±0.1 (0.055 ±0.004)	2.2 (0.087)	1.3 (0.051)	N/A	0.05 (0.002)	N/A	N/A	0.13 (0.005)	2.9 (0.114)	117
V	7343-19	7.3 ±0.3 (0.287 ±0.012)	4.3 ±0.3 (0.169 ±0.012)	1.8 ±0.1 <sup>*1</sup> (0.071 ±0.004)	2.4 (0.094)	1.3 (0.051)	N/A	0.05 (0.002)	N/A	N/A	0.13 (0.005)	3.8 (0.150)	274
W	7343-15	7.3 ±0.3 (0.287 ±0.012)	4.3 ±0.3 (0.169 ±0.012)	1.4 ±0.1 (0.055 ±0.004)	2.4 (0.094) 2.8 ±0.2 (0.110 ±0.008) <sup>*2</sup>	1.30 (0.051) S1 = 5.0 (0.197) <sup>*2</sup> S2 = 1.3 (0.051) <sup>*2</sup>	N/A	0.05 (0.002)	N/A	N/A	0.13 (0.005)	3.8 (0.150)	223
X	7343-43	7.3 ±0.3 (0.287 ±0.012)	4.3 ±0.3 (0.169 ±0.012)	4.0 ±0.3 (0.157 ±0.012)	2.4 (0.094)	1.3 (0.051)	0.5 (0.020)	0.10 ±0.10 (0.004 ±0.004)	1.7 (0.067)	1.0 (0.039)	0.13 (0.005)	3.8 (0.150)	554
Y	7343-40	7.3 ±0.3 (0.287 ±0.012)	4.3 ±0.3 (0.169 ±0.012)	3.8 ±0.2 (0.150 ±0.008)	2.4 (0.094)	1.3 (0.051)	0.5 (0.020)	0.10 ±0.10 (0.004 ±0.004)	1.7 (0.067)	1.0 (0.039)	0.13 (0.005)	3.8 (0.150)	494

\*1 Height tolerance is ±0.2 for V case T521 only

\*2 S1 and S2 is for T528 series only

\*3 Height tolerance is ±0.2 for: T520B with M & N terminations

## Dimensions – Millimeters cont.

### T523

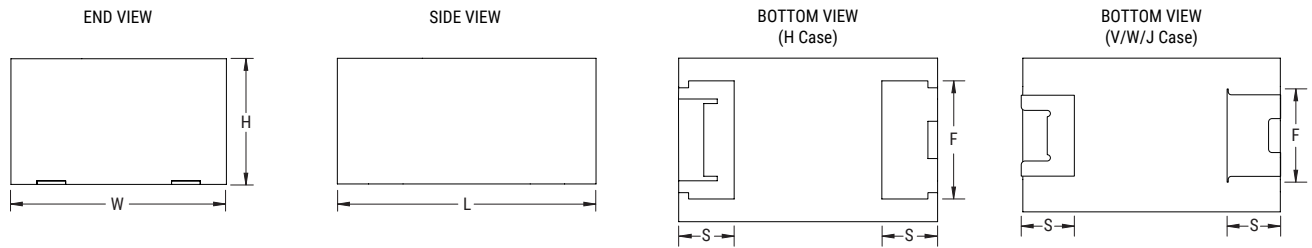

KEMET	EIA	L	W	H	F ±0.1 (±0.004)	S ±0.3 (±0.012)	Typical Weight (mg)
W	7343-15	7.3±0.3 (0.287±0.012)	4.3±0.3 (0.169±0.012)	1.4±0.1 (0.055±0.004)	2.4 (0.094)	1.3 (0.051)	223
J	7360-15	7.3±0.3 (0.287±0.012)	6.0±0.3 (0.236±0.012)	1.4±0.1 (0.055±0.004)	4.45 (0.175)	1.6 (0.063)	263
V	7343-20	7.3±0.3 (0.287±0.012)	4.3±0.3 (0.169±0.012)	1.9±0.1 (0.075±0.004)	2.4 (0.094)	1.3 (0.051)	274
H	7360-20	7.3±0.3 (0.287±0.012)	6.0±0.3 (0.236±0.012)	1.9±0.1 (0.075±0.004)	4.45 (0.175)	1.6 (0.063)	385

### T527/TF

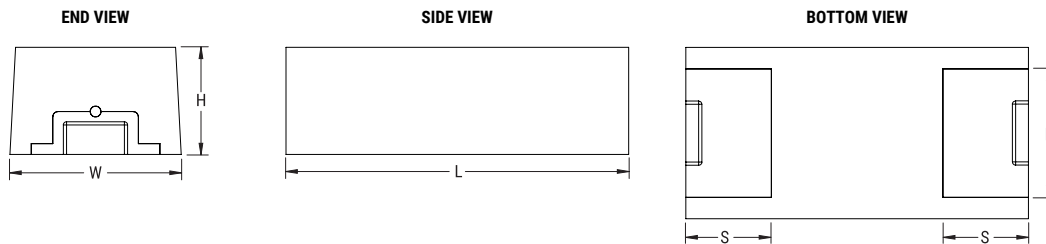

### T527 B-Case/T-Case

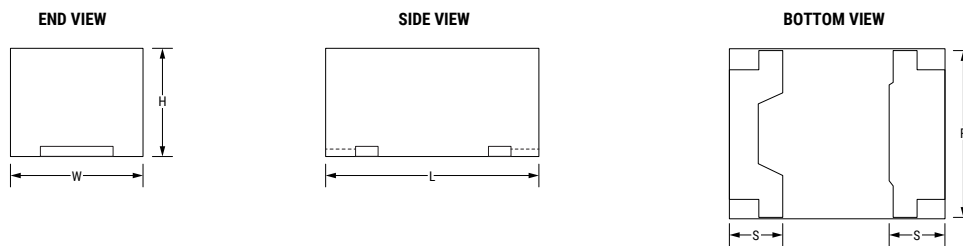

Case Size		Component Dimensions					Typical Weight
KEMET	EIA	L	W	H	F	S	(mg)
I	3216-10	3.2 ±0.2	1.6 ±0.2	0.9 ±0.1	1.2 ±0.1	0.8 ±0.2	70
08A	3216-08	3.2 ±0.2	1.6 ±0.2	0.8 Maximum	1.2 ±0.1	0.8 ±0.2	-
K	3528-10	3.2 ±0.2	2.8 ±0.2	1.0 Maximum	2.2 ±0.1	0.7 ±0.2	70
T	3528-12	3.5 ±0.2	2.8 ±0.2	1.1 ±0.1	2.2 ±0.1	0.7 ±0.2	55
S	3216-12	3.2 ±0.2	1.6 ±0.2	1.1 ±0.1	1.2 ±0.1	0.8 ±0.2	26.2

## Dimensions – Millimeters cont.

### T529

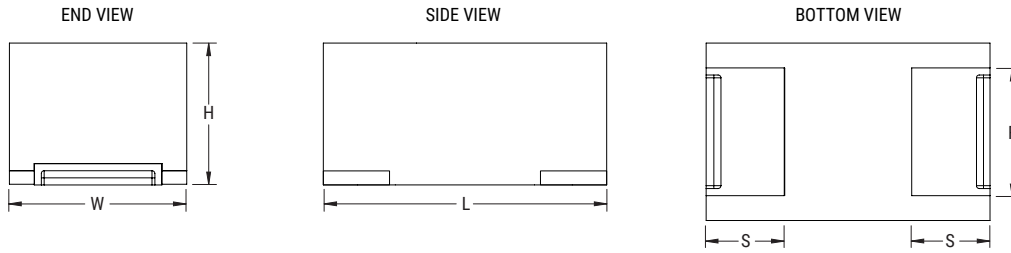

Case Size		Component Dimensions					Typical Weight
KEMET	EIA	L	W	H	F	S	(mg)
P	2012-10	2.0±0.1	1.25±0.1	1.0 maximum	0.9±0.1	0.55±0.1	11.4
I	3216-10	3.2±0.2	1.6±0.2	1.0 maximum	1.2±0.1	0.8±0.1	70

**Table 1 – Ratings & Part Number Reference**

Rated Voltage VDC at 105°C	Rated Capacitance	Case Code/Case Size	KEMET Part Number	DC Leakage	DF	ESR	Maximum Allowable Ripple Current	Endurance	MSL	Maximum Operating Temperature	Derating Category
Not all parts are 105°C rated	µF	KEMET/EIA	(See below for part options)	µA at 25°C Maximum/ 5 Minutes	% at 25°C 120 Hz Maximum	mΩ at 25°C 100 kHz Maximum	(rms) mA at +45°C 100 kHz	(Hours)	Reflow Temp ≤ 260°C	°C	
2	470	V/7343-19	T520V477M002A(3)E040	94	10	40	2,200	2,000	3	105	3
2.5	47	A/3216-18	T520A476M2R5ATE090 ^	11.75	8 *	90	1,100	2,000	3	105	3
2.5	68	A/3216-18	T520A686M2R5ATE070 ^	17	8 *	70	1,300	2,000	3	105	3
2.5	68	A/3216-18	T520A686M2R5ATE080 ^	17	8 *	80	1,200	2,000	3	105	3
2.5	100	T/3528-12	T520T107M2R5A(3)E040	25	8	40	1,600	2,000	3	105	3
2.5	100	T/3528-12	T520T107M2R5A(3)E070	25	8	70	1,220	2,000	3	105	3
2.5	100	T/3528-12	T525T107M2R5A(3)E080	25	10	80	1,100	2,000	3	125	5
2.5	100	B/3528-21	T520B107M2R5A(3)E025	25	8	25	2,300	2,000	3	105	3
2.5	100	B/3528-21	T520B107M2R5A(3)E035	25	8	35	1,900	2,000	3	105	3
2.5	100	B/3528-21	T520B107M2R5A(3)E040	25	8	40	1,800	2,000	3	105	3
2.5	100	B/3528-21	T520B107M2R5A(3)E070	25	8	70	1,350	2,000	3	105	3
2.5	150	U/6032-15	T520U157M2R5A(3)E055	37.5	8	55	1,600	2,000	3	105	3
2.5	220	A/3216-18	T520A227M2R5ATE025 ^	55	8 *	25	1,732	2,000	3	105	3
2.5	220	A/3216-18	T520A227M2R5ATE035 ^	55	8 *	35	1,500	2,000	3	105	3
2.5	220	B/3528-21	T520B227M2R5A(3)E015	55	8	15	2,900	2,000	3	105	3
2.5	220	B/3528-21	T520B227M2R5A(3)E018	55	8	18	2,700	2,000	3	105	3
2.5	220	B/3528-21	T520B227M2R5A(3)E021	55	8	21	2,500	2,000	3	105	3
2.5	220	B/3528-21	T520B227M2R5A(3)E025	55	8	25	2,300	2,000	3	105	3
2.5	220	B/3528-21	T520B227M2R5A(3)E030	55	8	30	2,100	2,000	3	105	3
2.5	220	B/3528-21	T520B227M2R5A(3)E035	55	8	35	1,900	2,000	3	105	3
2.5	220	B/3528-21	T520B227M2R5A(3)E055	55	8	55	1,500	2,000	3	105	3
2.5	220	B/3528-21	T520B227M2R5A(3)E070	55	8	70	1,350	2,000	3	105	3
2.5	220	T/3528-12	T520T227M2R5ATE070 ^	55	10 *	70	1,200	2,000	3	105	3
2.5	220	T/3528-12	T520T227M2R5ATE035 ^	55	8 *	35	1,464	2,000	3	105	3
2.5	220	T/3528-12	T520T227M2R5ATE030 ^	55	10 *	30	1,580	2,000	3	105	3
2.5	220	U/6032-15	T520U227M2R5A(3)E055	55	8	55	1,600	2,000	3	105	3
2.5	220	C/6032-28	T520C227M2R5A(3)E025	55	8	25	2,600	2,000	3	105	3
2.5	220	C/6032-28	T520C227M2R5A(3)E045	55	8	45	1,900	2,000	3	105	3
2.5	220	W/7343-15	T520W227M2R5A(3)E025	55	10	25	2,700	2,000	3	105	3
2.5	220	V/7343-19	T520V227M2R5A(3)E006	55	10	6	5,600	2,000	3	105	3
2.5	220	V/7343-19	T520V227M2R5A(3)E007	55	10	7	5,200	2,000	3	105	3
2.5	220	V/7343-19	T520V227M2R5A(3)E009	55	10	9	4,600	2,000	3	105	3
2.5	220	V/7343-19	T520V227M2R5A(3)E012	55	10	12	3,900	2,000	3	105	3
2.5	220	V/7343-19	T520V227M2R5A(3)E015	55	10	15	3,500	2,000	3	105	3
2.5	220	V/7343-19	T520V227M2R5A(3)E025	55	10	25	2,700	2,000	3	105	3
2.5	220	V/7343-19	T520V227M2R5A(3)E045	55	10	45	2,000	2,000	3	105	3
2.5	220	D/7343-31	T520D227M2R5A(3)E007	55	10	7	5,700	2,000	3	105	3
2.5	220	D/7343-31	T520D227M2R5A(3)E040	55	10	40	2,400	2,000	3	105	3
2.5	330	B/3528-21	T520B337M2R5ATE009 ^	82.5	8 *	9	3,073	1,000	3	105	3
2.5	330	B/3528-21	T520B337M2R5NTE009 ^	82.5	8 *	9	3,073	2,000	3	105	3
2.5	330	B/3528-21	T520B337M2R5ATE012 ^	83	8 *	12	2,700	2,000	3	105	3
VDC at 105°C	µF	KEMET/EIA	(See below for part options)	µA at 25°C Maximum/ 5 Minutes	% at 25°C 120 Hz Maximum	mΩ at 25°C 100 kHz Maximum	mA at +45°C 100 kHz	(Hours)	Reflow Temp ≤ 260°C	°C	
Rated Voltage	Rated Capacitance	Case Code/Case Size	KEMET Part Number	DC Leakage	DF	ESR	Maximum Allowable Ripple Current	Endurance	MSL	Maximum Operating Temp	Derating Category

(2) To complete KEMET part number, insert M for ±20% or K for ±10%. Designates Capacitance tolerance.

(3) To complete KEMET part number, insert T = 100% Matte Tin (Sn)-plated or H = Standard Solder coated (SnPb 5% Pb minimum). Refer to Ordering Information for additional detail.

Higher voltage ratings and tighter ESR may be substituted within the same size at KEMET's option. Voltage substitutions will be marked with the higher voltage rating. Substitutions can include better than series.

Part numbers marked in blue font are not recommended for new designs. Please use the T521 series instead.

^ Denotes the large reel (13") is not available.

\* DF measurement condition is 120 Hz/0.5 V<sub>rms</sub>/1.5 V DC Bias  
Refer to Ordering Information for additional detail.

**Table 1 – Ratings & Part Number Reference cont.**

Rated Voltage VDC at 105°C	Rated Capacitance	Case Code/ Case Size	KEMET Part Number	DC Leakage	DF	ESR	Maximum Allowable Ripple Current	Endurance	MSL	Maximum Operating Temperature	Derating Category
Not all parts are 105°C rated	µF	KEMET/EIA	(See below for part options)	µA at 25°C Maximum/ 5 Minutes	% at 25°C 120 Hz Maximum	mΩ at 25°C 100 kHz Maximum	(rms) mA at +45°C 100 kHz	(Hours)	Reflow Temp ≤ 260°C	°C	
2.5	330	B/3528-21	T520B337M2R5A(3)E015	82.5	8	15	2,900	2,000	3	105	3
2.5	330	B/3528-21	T520B337M2R5A(3)E018	82.5	8	18	2,700	2,000	3	105	3
2.5	330	B/3528-21	T520B337M2R5A(3)E035	82.5	8	35	1,900	2,000	3	105	3
2.5	330	B/3528-21	T520B337M2R5A(3)E045	82.5	8	45	1,700	2,000	3	105	3
2.5	330	B/3528-21	T520B337M2R5A(3)E070	82.5	8	70	1,350	2,000	3	105	3
2.5	330	C/6032-28	T520C337M2R5A(3)E015	82.5	8	15	3,300	2,000	3	105	3
2.5	330	C/6032-28	T520C337M2R5A(3)E018	82.5	8	18	3,000	2,000	3	105	3
2.5	330	C/6032-28	T520C337M2R5A(3)E025	82.5	8	25	2,600	2,000	3	105	3
2.5	330	C/6032-28	T520C337M2R5A(3)E045	82.5	8	45	1,900	2,000	3	105	3
2.5	330	L/6032-19	T520L337M2R5A(3)E015	82.5	8	9	4,100	2,000	3	105	3
2.5	330	L/6032-19	T520L337M2R5A(3)E012	82.5	8	12	3,500	2,000	3	105	3
2.5	330	L/6032-19	T520L337M2R5A(3)E025	82.5	8	25	2,400	2,000	3	105	3
2.5	330	W/7343-15	T520W337M2R5A(3)E015	82.5	10	15	3,500	2,000	3	105	3
2.5	330	W/7343-15	T520W337M2R5A(3)E025	82.5	10	25	2,700	2,000	3	105	3
2.5	330	W/7343-15	T520W337M2R5A(3)E040	82.5	10	40	2,100	2,000	3	105	3
2.5	330	V/7343-19	T520V337M2R5A(3)E006	82.5	10	6	5,600	2,000	3	105	3
2.5	330	V/7343-19	T520V337M2R5A(3)E007	82.5	10	7	5,200	2,000	3	105	3
2.5	330	V/7343-19	T520V337M2R5A(3)E009	82.5	10	9	4,600	2,000	3	105	3
2.5	330	V/7343-19	T520V337M2R5A(3)E012	82.5	10	12	3,900	2,000	3	105	3
2.5	330	V/7343-19	T520V337M2R5A(3)E015	82.5	10	15	3,500	2,000	3	105	3
2.5	330	V/7343-19	T520V337M2R5A(3)E018	82.5	10	18	3,200	2,000	3	105	3
2.5	330	V/7343-19	T520V337M2R5A(3)E025	82.5	10	25	2,700	2,000	3	105	3
2.5	330	V/7343-19	T520V337M2R5A(3)E040	82.5	10	40	2,200	2,000	3	105	3
2.5	330	D/7343-31	T520D337M2R5A(3)E006	82.5	10	6	6,100	2,000	3	105	3
2.5	330	D/7343-31	T520D337M2R5A(3)E007	82.5	10	7	5,700	2,000	3	105	3
2.5	330	D/7343-31	T525D337M2R5A(3)E025	82.5	10	25	3,000	2,000	3	125	5
2.5	470	B/3528-21	T520B477M2R5ATE014 ^	188	8 *	14	3,000	1,000	3	85	1
2.5	470	V/7343-19	T520V477M2R5A(3)E006	117.5	10	6	5,600	2,000	3	105	3
2.5	470	V/7343-19	T520V477M2R5A(3)E007	117.5	10	7	5,200	2,000	3	105	3
2.5	470	V/7343-19	T520V477M2R5A(3)E009	117.5	10	9	4,600	2,000	3	105	3
2.5	470	V/7343-19	T520V477M2R5A(3)E012	117.5	10	12	3,900	2,000	3	105	3
2.5	470	V/7343-19	T520V477M2R5A(3)E015	117.5	10	15	3,500	2,000	3	105	3
2.5	470	V/7343-19	T520V477M2R5A(3)E018	117.5	10	18	3,200	2,000	3	105	3
2.5	470	C/6032-28	T520C477M2R5A(3)E025	117.5	8	25	2,600	2,000	3	105	3
2.5	470	C/6032-28	T520C477M2R5A(3)E045	117.5	8	45	1,900	2,000	3	105	3
2.5	470	D/7343-31	T530D477M2R5A(3)E005	117.5	8	5	7,100	2,000	3	125	5
2.5	470	D/7343-31	T520D477M2R5A(3)E006	117.5	10	6	6,100	2,000	3	105	3
2.5	470	D/7343-31	T530D477M2R5A(3)E006	117.5	8	6	6,500	2,000	3	125	5
2.5	470	D/7343-31	T520D477M2R5A(3)E007	117.5	10	7	5,700	2,000	3	105	3
2.5	470	D/7343-31	T520D477M2R5A(3)E009	117.5	10	9	5,000	2,000	3	105	3
2.5	470	D/7343-31	T530D477M2R5A(3)E010	117.5	8	10	5,000	2,000	3	125	5
VDC at 105°C	µF	KEMET/EIA	(See below for part options)	µA at 25°C Maximum/ 5 Minutes	% at 25°C 120 Hz Maximum	mΩ at 25°C 100 kHz Maximum	mA at +45°C 100 kHz	(Hours)	Reflow Temp ≤ 260°C	°C	
Rated Voltage	Rated Capacitance	Case Code/ Case Size	KEMET Part Number	DC Leakage	DF	ESR	Maximum Allowable Ripple Current	Endurance	MSL	Maximum Operating Temp	Derating Category

(2) To complete KEMET part number, insert M for ±20% or K for ±10%. Designates Capacitance tolerance.

(3) To complete KEMET part number, insert T = 100% Matte Tin (Sn)-plated or H = Standard Solder coated (SnPb 5% Pb minimum). Refer to Ordering Information for additional detail.

Higher voltage ratings and tighter ESR may be substituted within the same size at KEMET's option. Voltage substitutions will be marked with the higher voltage rating. Substitutions can include better than series.

**Part numbers marked in blue font are not recommended for new designs. Please use the T521 series instead.**

^ Denotes the large reel (13") is not available.

\* DF measurement condition is 120 Hz/0.5 V<sub>rms</sub>/1.5 V DC Bias  
Refer to Ordering Information for additional detail.

**Table 1 – Ratings & Part Number Reference cont.**

Rated Voltage VDC at 105°C	Rated Capacitance	Case Code/Case Size	KEMET Part Number	DC Leakage	DF	ESR	Maximum Allowable Ripple Current	Endurance	MSL	Maximum Operating Temperature	Derating Category
Not all parts are 105°C rated	µF	KEMET/EIA	(See below for part options)	µA at 25°C Maximum/ 5 Minutes	% at 25°C 120 Hz Maximum	mΩ at 25°C 100 kHz Maximum	(rms) mA at +45°C 100 kHz	(Hours)	Reflow Temp ≤ 260°C	°C	
2.5	470	D/7343-31	T525D477M2R5A(3)E025	117.5	10	25	3,000	2,000	3	125	5
2.5	560	D/7343-31	T530D567M2R5A(3)E005	140	8	5	7,100	2,000	3	125	5
2.5	680	D/7343-31	T530D687M2R5A(3)E006	170	8	6	6,500	2,000	3	125	5
2.5	680	D/7343-31	T530D687M2R5A(3)E007	170	8	7	6,000	2,000	3	125	5
2.5	680	D/7343-31	T520D687M2R5A(3)E010	170	10	10	4,700	2,000	3	105	3
2.5	680	D/7343-31	T530D687M2R5A(3)E010	170	8	10	5,000	2,000	3	125	5
2.5	680	D/7343-31	T520D687M2R5A(3)E015	170	10	15	3,900	2,000	3	105	3
2.5	680	D/7343-31	T525D687M2R5A(3)E025	170	10	25	3,000	2,000	3	125	5
2.5	680	D/7343-31	T520D687M2R5A(3)E040	170	10	40	2,400	2,000	3	105	3
2.5	680	Y/7343-40	T530Y687M2R5A(3)E005	170	8	5	7,300	2,000	3	125	5
2.5	680	Y/7343-40	T530Y687M2R5A(3)E006	170	8	6	6,600	2,000	3	125	5
2.5	680	Y/7343-40	T530Y687M2R5A(3)E007	170	8	7	6,100	2,000	3	125	5
2.5	680	Y/7343-40	T520Y687M2R5A(3)E015	170	10	15	4,000	2,000	3	105	3
2.5	680	Y/7343-40	T520Y687M2R5A(3)E025	170	10	25	3,100	2,000	3	105	3
2.5	680	X/7343-43	T530X687M2R5A(3)E006	170	8	6	6,700	2,000	3	125	5
2.5	1000	D/7343-31	T520D108M2R5A(3)E006	250	10	6	6,100	2,000	3	105	3
2.5	1000	D/7343-31	T520D108M2R5A(3)E007	250	10	7	5,700	2,000	3	105	3
2.5	1000	D/7343-31	T520D108M2R5A(3)E009	250	10	9	5,000	2,000	3	105	3
2.5	1000	D/7343-31	T520D108M2R5A(3)E010	250	10	10	4,700	2,000	3	105	3
2.5	1000	D/7343-31	T520D108M2R5A(3)E015	250	10	15	3,900	2,000	3	105	3
2.5	1000	D/7343-31	T520D108M2R5A(3)E030	250	10	30	2,700	2,000	3	105	3
2.5	1000	Y/7343-40	T530Y108M2R5A(3)E005	250	8	5	7,300	2,000	3	125	5
2.5	1000	Y/7343-40	T530Y108M2R5A(3)E006	250	8	6	6,600	2,000	3	125	5
2.5	1000	Y/7343-40	T520Y108M2R5A(3)E010	250	10	10	4,900	2,000	3	105	3
2.5	1000	Y/7343-40	T520Y108M2R5A(3)E015	250	10	15	4,000	2,000	3	105	3
2.5	1000	Y/7343-40	T520Y108M2R5A(3)E025	250	10	25	3,100	2,000	3	105	3
2.5	1000	X/7343-43	T530X108M2R5A(3)E004	250	8	4	8,200	2,000	3	125	5
2.5	1000	X/7343-43	T530X108M2R5A(3)E005	250	8	5	7,300	2,000	3	125	5
2.5	1000	X/7343-43	T530X108M2R5A(3)E006	250	8	6	6,700	2,000	3	125	5
2.5	1000	X/7343-43	T520X108M2R5A(3)E010	250	10	10	5,000	2,000	3	105	3
2.5	1500	Y/7343-40	T520Y158M2R5A(3)E015	375	10	15	4,000	2,000	3	105	3
2.5	1500	X/7343-43	T530X158M2R5A(3)E005	375	8	5	7,300	2,000	3	125	5
2.5	1500	X/7343-43	T520X158M2R5A(3)E015	375	10	15	4,100	2,000	3	105	3
3	100	B/3528-21	T525B107M003A(3)E080	30	8	80	1,300	2,000	3	125	5
3	100	B/3528-21	T520B107M003A(3)E025	30	8	25	2,300	2,000	3	105	3
3	100	B/3528-21	T520B107M003A(3)E035	30	8	35	1,900	2,000	3	105	3
3	100	B/3528-21	T520B107M003A(3)E040	30	8	40	1,800	2,000	3	105	3
3	100	B/3528-21	T520B107M003A(3)E070	30	8	70	1,350	2,000	3	105	3
3	150	B/3528-21	T520B157M003A(3)E025	45	8	25	2,300	2,000	3	105	3
3	150	B/3528-21	T520B157M003A(3)E035	45	8	35	1,900	2,000	3	105	3
3	150	B/3528-21	T520B157M003A(3)E040	45	8	40	1,800	2,000	3	105	3
VDC at 105°C	µF	KEMET/EIA	(See below for part options)	µA at 25°C Maximum/ 5 Minutes	% at 25°C 120 Hz Maximum	mΩ at 25°C 100 kHz Maximum	mA at +45°C 100 kHz	(Hours)	Reflow Temp ≤ 260°C	°C	
Rated Voltage	Rated Capacitance	Case Code/Case Size	KEMET Part Number	DC Leakage	DF	ESR	Maximum Allowable Ripple Current	Endurance	MSL	Maximum Operating Temp	Derating Category

(2) To complete KEMET part number, insert M for ±20% or K for ±10%. Designates Capacitance tolerance.

(3) To complete KEMET part number, insert T = 100% Matte Tin (Sn)-plated or H = Standard Solder coated (SnPb 5% Pb minimum). Refer to Ordering Information for additional detail.

Higher voltage ratings and tighter ESR may be substituted within the same size at KEMET's option. Voltage substitutions will be marked with the higher voltage rating. Substitutions can include better than series.

**Part numbers marked in blue font are not recommended for new designs. Please use the T521 series instead.**

^ Denotes the large reel (13") is not available.

\* DF measurement condition is 120 Hz/0.5 V<sub>rms</sub>/1.5 V DC Bias  
Refer to Ordering Information for additional detail.

**Table 1 – Ratings & Part Number Reference cont.**

Rated Voltage VDC at 105°C	Rated Capacitance	Case Code/Case Size	KEMET Part Number	DC Leakage	DF	ESR	Maximum Allowable Ripple Current	Endurance	MSL	Maximum Operating Temperature	Derating Category
Not all parts are 105°C rated	µF	KEMET/EIA	(See below for part options)	µA at 25°C Maximum/ 5 Minutes	% at 25°C 120 Hz Maximum	mΩ at 25°C 100 kHz Maximum	(rms) mA at +45°C 100 kHz	(Hours)	Reflow Temp ≤ 260°C	°C	
3	150	B/3528-21	T520B157M003A(3)E070	45	8	70	1,350	2,000	3	105	3
3	150	B/3528-21	T525B157M003A(3)E080	45	8	80	1,300	2,000	3	125	5
3	330	V/7343-19	T520V337M003A(3)E009	99	10	9	4,600	2,000	3	105	3
3	330	V/7343-19	T520V337M003A(3)E012	99	10	12	3,900	2,000	3	105	3
3	330	V/7343-19	T520V337M003A(3)E015	99	10	15	3,500	2,000	3	105	3
3	330	V/7343-19	T520V337M003A(3)E025	99	10	25	2,700	2,000	3	105	3
3	330	D/7343-31	T525D337M003A(3)E025	99	10	25	3,000	2,000	3	125	5
3	470	D/7343-31	T530D477M003A(3)E010	141	8	10	5,000	2,000	3	125	5
3	470	D/7343-31	T525D477M003A(3)E025	141	10	25	3,000	2,000	3	125	5
3	680	D/7343-31	T530D687M003A(3)E010	204	8	10	5,000	2,000	3	125	5
3	680	D/7343-31	T520D687M003A(3)E015	204	10	15	3,900	2,000	3	105	3
3	680	D/7343-31	T525D687M003A(3)E025	204	10	25	3,000	2,000	3	125	5
3	680	D/7343-31	T520D687M003A(3)E040	204	10	40	2,400	2,000	3	105	3
3	1000	X/7343-43	T530X108M003A(3)E010	300	8	10	5,200	2,000	3	125	5
3	1000	X/7343-43	T520X108M003A(3)E015	300	10	15	4,100	2,000	3	105	3
3	1000	X/7343-43	T520X108M003A(3)E030	300	10	30	2,900	2,000	3	105	3
3	1500	X/7343-43	T530X158M003A(3)E008	450	8	8	5,800	2,000	3	125	5
4	15	T/3528-12	T520T156M004A(3)E100	6	8	100	1,000	2,000	3	105	3
4	33	A/3216-18	T520A336M004ATE070 ^	13.2	8*	70	1,300	2,000	3	105	3
4	33	A/3216-18	T520A336M004ATE080 ^	13.2	8*	80	1,200	2,000	3	105	3
4	47	A/3216-18	T520A476M004ATE070 ^	18.8	8*	70	1,300	2,000	3	105	3
4	47	A/3216-18	T520A476M004ATE080 ^	18.8	8*	80	1,200	2,000	3	105	3
4	47	T/3528-12	T520T476M004A(3)E070	18.8	8	70	1,220	2,000	3	105	3
4	68	A/3216-18	T520A686M004ATE180 ^	27	8*	180	800	2,000	3	105	3
4	68	T/3528-12	T520T686M004A(3)E070	27.2	8	70	1,220	2,000	3	105	3
4	68	B/3528-21	T520B686M004A(3)E025	27.2	8	25	2,300	2,000	3	105	3
4	68	B/3528-21	T520B686M004A(3)E035	27.2	8	35	1,900	2,000	3	105	3
4	68	B/3528-21	T520B686M004A(3)E040	27.2	8	40	1,800	2,000	3	105	3
4	68	B/3528-21	T520B686M004A(3)E070	27.2	8	70	1,350	2,000	3	105	3
4	68	B/3528-21	T525B686M004A(3)E080	27.2	8	80	1,300	2,000	3	125	5
4	68	U/6032-15	T520U686M004A(3)E055	27.2	8	55	1,600	2,000	3	105	3
4	100	I/3216-10	T527I107M004ATE200 ^	40	8*	200	775	1,000	3	105	3
4	100	A/3216-18	T520A107M004ATE150 ^	40	8*	150	900	2,000	3	105	3
4	100	A/3216-18	T520A107M004ATE200 ^	40	8*	200	700	2,000	3	105	3
4	100	T/3528-12	T520T107M004A(3)E070	40	8	70	1,220	2,000	3	105	3
4	100	T/3528-12	T520T107M004A(3)E150	40	8	150	800	2,000	3	105	3
4	100	B/3528-21	T520B107M004A(3)E025	40	8	25	2,300	2,000	3	105	3
4	100	B/3528-21	T520B107M004A(3)E035	40	8	35	1,900	2,000	3	105	3
4	100	B/3528-21	T520B107M004A(3)E040	40	8	40	1,800	2,000	3	105	3
4	100	B/3528-21	T520B107M004A(3)E070	40	8	70	1,350	2,000	3	105	3
4	100	B/3528-21	T525B107M004A(3)E080	40	8	80	1,300	2,000	3	125	5
VDC at 105°C	µF	KEMET/EIA	(See below for part options)	µA at 25°C Maximum/ 5 Minutes	% at 25°C 120 Hz Maximum	mΩ at 25°C 100 kHz Maximum	mA at +45°C 100 kHz	(Hours)	Reflow Temp ≤ 260°C	°C	
Rated Voltage	Rated Capacitance	Case Code/Case Size	KEMET Part Number	DC Leakage	DF	ESR	Maximum Allowable Ripple Current	Endurance	MSL	Maximum Operating Temp	Derating Category

(2) To complete KEMET part number, insert M for ±20% or K for ±10%. Designates Capacitance tolerance.

(3) To complete KEMET part number, insert T = 100% Matte Tin (Sn)-plated or H = Standard Solder coated (SnPb 5% Pb minimum). Refer to Ordering Information for additional detail.

Higher voltage ratings and tighter ESR may be substituted within the same size at KEMET's option. Voltage substitutions will be marked with the higher voltage rating. Substitutions can include better than series.

**Part numbers marked in blue font are not recommended for new designs. Please use the T521 series instead.**

^ Denotes the large reel (13") is not available.

\* DF measurement condition is 120 Hz/0.5 V<sub>rms</sub>/1.5 V DC Bias  
Refer to Ordering Information for additional detail.

**Table 1 – Ratings & Part Number Reference cont.**

Rated Voltage VDC at 105°C	Rated Capacitance	Case Code/Case Size	KEMET Part Number	DC Leakage	DF	ESR	Maximum Allowable Ripple Current	Endurance	MSL	Maximum Operating Temperature	Derating Category
Not all parts are 105°C rated	µF	KEMET/EIA	(See below for part options)	µA at 25°C Maximum/ 5 Minutes	% at 25°C 120 Hz Maximum	mΩ at 25°C 100 kHz Maximum	(rms) mA at +45°C 100 kHz	(Hours)	Reflow Temp ≤ 260°C	°C	
4	100	U/6032-15	T520U107M004A(3)E055	40	8	55	1,600	2,000	3	105	3
4	150	B/3528-21	T520B157M004A(3)E015	60	8	15	2,900	2,000	3	105	3
4	150	B/3528-21	T520B157M004A(3)E018	60	8	18	2,700	2,000	3	105	3
4	150	B/3528-21	T520B157M004A(3)E025	60	8	25	2,300	2,000	3	105	3
4	150	B/3528-21	T520B157M004A(3)E030	60	8	30	2,100	2,000	3	105	3
4	150	B/3528-21	T520B157M004A(3)E035	60	8	35	1,900	2,000	3	105	3
4	150	B/3528-21	T520B157M004A(3)E040	60	8	40	1,800	2,000	3	105	3
4	150	B/3528-21	T520B157M004A(3)E070	60	8	70	1,350	2,000	3	105	3
4	150	U/6032-15	T520U157M004A(3)E055	60	8	55	1,600	2,000	3	105	3
4	150	C/6032-28	T520C157M004A(3)E015	60	8	15	3,300	2,000	3	105	3
4	150	C/6032-28	T520C157M004A(3)E025	60	8	25	2,600	2,000	3	105	3
4	150	C/6032-28	T520C157M004A(3)E045	60	8	45	1,900	2,000	3	105	3
4	150	C/6032-28	T520C157M004A(3)E100	60	8	100	1,300	2,000	3	105	3
4	150	V/7343-19	T520V157M004A(3)E007	60	10	7	5,200	2,000	3	105	3
4	150	V/7343-19	T520V157M004A(3)E009	60	10	9	4,600	2,000	3	105	3
4	150	V/7343-19	T520V157M004A(3)E012	60	10	12	3,900	2,000	3	105	3
4	150	V/7343-19	T520V157M004A(3)E015	60	10	15	3,500	2,000	3	105	3
4	150	V/7343-19	T520V157M004A(3)E025	60	10	25	2,700	2,000	3	105	3
4	150	D/7343-31	T520D157M004A(3)E007	60	10	7	5,700	2,000	3	105	3
4	220	K/3528-10	T527K227M004APE025 ^	88	10 *	25	1,732	1,000	3	105	3
4	220	K/3528-10	T527K227M004APE030 ^	88	10 *	30	1,581	1,000	3	105	3
4	220	T/3528-12	T520T227M004ATE025 ^	176	10 *	25	2,050	2,000	3	105	3
4	220	T/3528-12	T520T227M004ATE030 ^	176	10 *	30	1,870	2,000	3	105	3
4	220	T/3528-12	T520T227M004ATE035 ^	176	10 *	35	1,463	2,000	3	105	3
4	220	B/3528-21	T520B227M004A(3)E035	88	8	35	1,900	2,000	3	105	3
4	220	B/3528-21	T520B227M004A(3)E045	88	8	45	1,700	2,000	3	105	3
4	220	B/3528-21	T520B227M004A(3)E070	88	8	70	1,350	2,000	3	105	3
4	220	C/6032-28	T520C227M004A(3)E015	88	8	15	3,300	2,000	3	105	3
4	220	C/6032-28	T520C227M004A(3)E018	88	8	18	3,000	2,000	3	105	3
4	220	C/6032-28	T520C227M004A(3)E025	88	8	25	2,600	2,000	3	105	3
4	220	C/6032-28	T520C227M004A(3)E045	88	8	45	1,900	2,000	3	105	3
4	220	C/6032-28	T520C227M004A(3)E055	88	8	55	1,700	2,000	3	105	3
4	220	L/6032-19	T520L227M004A(3)E012	88	8	12	3,500	2,000	3	105	3
4	220	L/6032-19	T520L227M004A(3)E025	88	8	25	2,400	2,000	3	105	3
4	220	W/7343-15	T520W227M004A(3)E025	88	10	25	2,700	2,000	3	105	3
4	220	W/7343-15	T520W227M004A(3)E040	88	10	40	2,100	2,000	3	105	3
4	220	V/7343-19	T520V227M004A(3)E006	88	10	6	5,600	2,000	3	105	3
4	220	V/7343-19	T520V227M004A(3)E007	88	10	7	5,200	2,000	3	105	3
4	220	V/7343-19	T520V227M004A(3)E009	88	10	9	4,600	2,000	3	105	3
4	220	V/7343-19	T520V227M004A(3)E012	88	10	12	3,900	2,000	3	105	3
4	220	V/7343-19	T520V227M004A(3)E015	88	10	15	3,500	2,000	3	105	3
VDC at 105°C	µF	KEMET/EIA	(See below for part options)	µA at 25°C Maximum/ 5 Minutes	% at 25°C 120 Hz Maximum	mΩ at 25°C 100 kHz Maximum	mA at +45°C 100 kHz	(Hours)	Reflow Temp ≤ 260°C	°C	
Rated Voltage	Rated Capacitance	Case Code/Case Size	KEMET Part Number	DC Leakage	DF	ESR	Maximum Allowable Ripple Current	Endurance	MSL	Maximum Operating Temp	Derating Category

(2) To complete KEMET part number, insert M for ±20% or K for ±10%. Designates Capacitance tolerance.

(3) To complete KEMET part number, insert T = 100% Matte Tin (Sn)-plated or H = Standard Solder coated (SnPb 5% Pb minimum). Refer to Ordering Information for additional detail.

Higher voltage ratings and tighter ESR may be substituted within the same size at KEMET's option. Voltage substitutions will be marked with the higher voltage rating. Substitutions can include better than series.

**Part numbers marked in blue font are not recommended for new designs. Please use the T521 series instead.**

^ Denotes the large reel (13") is not available.

\* DF measurement condition is 120 Hz/0.5 V<sub>rms</sub>/1.5 V DC Bias  
Refer to Ordering Information for additional detail.

**Table 1 – Ratings & Part Number Reference cont.**

Rated Voltage VDC at 105°C	Rated Capacitance	Case Code/Case Size	KEMET Part Number	DC Leakage	DF	ESR	Maximum Allowable Ripple Current	Endurance	MSL	Maximum Operating Temperature	Derating Category
Not all parts are 105°C rated	µF	KEMET/EIA	(See below for part options)	µA at 25°C Maximum/ 5 Minutes	% at 25°C 120 Hz Maximum	mΩ at 25°C 100 kHz Maximum	(rms) mA at +45°C 100 kHz	(Hours)	Reflow Temp ≤ 260°C	°C	
4	220	V/7343-19	T520V227M004A(3)E018	88	10	18	3,200	2,000	3	105	3
4	220	V/7343-19	T520V227M004A(3)E025	88	10	25	2,700	2,000	3	105	3
4	220	V/7343-19	T520V227M004A(3)E040	88	10	40	2,200	2,000	3	105	3
4	220	V/7343-19	T520V227M004A(3)E045	88	10	45	2,000	2,000	3	105	3
4	220	D/7343-31	T520D227M004A(3)E006	88	10	6	6,100	2,000	3	105	3
4	220	D/7343-31	T520D227M004A(3)E007	88	10	7	5,700	2,000	3	105	3
4	220	D/7343-31	T520D227M004A(3)E012	88	10	12	4,300	2,000	3	105	3
4	220	D/7343-31	T525D227M004A(3)E025	88	10	25	3,000	2,000	3	125	5
4	220	D/7343-31	T520D227M004A(3)E065	88	10	65	1,900	2,000	3	105	3
4	330	C/6032-28	T520C337M004A(3)E025	132	8	25	2,600	2,000	3	105	3
4	330	C/6032-28	T520C337M004A(3)E045	132	8	45	1,900	2,000	3	105	3
4	330	V/7343-19	T520V337M004A(3)E007	132	10	7	5,200	2,000	3	105	3
4	330	V/7343-19	T520V337M004A(3)E009	132	10	9	4,600	2,000	3	105	3
4	330	V/7343-19	T520V337M004A(3)E012	132	10	12	3,900	2,000	3	105	3
4	330	V/7343-19	T520V337M004A(3)E018	132	10	18	3,200	2,000	3	105	3
4	330	V/7343-19	T520V337M004A(3)E025	132	10	25	2,700	2,000	3	105	3
4	330	V/7343-19	T520V337M004A(3)E040	132	10	40	2,200	2,000	3	105	3
4	330	D/7343-31	T530D337M004A(3)E005	132	8	5	7,100	2,000	3	125	5
4	330	D/7343-31	T520D337M004A(3)E006	132	10	6	6,100	2,000	3	105	3
4	330	D/7343-31	T530D337M004A(3)E006	132	8	6	6,500	2,000	3	125	5
4	330	D/7343-31	T520D337M004A(3)E007	132	10	7	5,700	2,000	3	105	3
4	330	D/7343-31	T520D337M004A(3)E009	132	10	9	5,000	2,000	3	105	3
4	330	D/7343-31	T520D337M004A(3)E012	132	10	12	4,300	2,000	3	105	3
4	330	D/7343-31	T520D337M004A(3)E015	132	10	15	3,900	2,000	3	105	3
4	330	D/7343-31	T525D337M004A(3)E025	132	10	25	3,000	2,000	3	125	5
4	330	D/7343-31	T520D337M004A(3)E040	132	10	40	2,400	2,000	3	105	3
4	330	D/7343-31	T520D337M004A(3)E045	132	10	45	2,200	2,000	3	105	3
4	470	D/7343-31	T530D477M004A(3)E006	188	8	6	6,500	2,000	3	125	5
4	470	D/7343-31	T520D477M004A(3)E010	188	10	10	4,700	2,000	3	105	3
4	470	D/7343-31	T530D477M004A(3)E010	188	8	10	5,000	2,000	3	125	5
4	470	D/7343-31	T520D477M004A(3)E012	188	10	12	4,300	2,000	3	105	3
4	470	D/7343-31	T520D477M004A(3)E015	188	10	15	3,900	2,000	3	105	3
4	470	D/7343-31	T520D477M004A(3)E018	188	10	18	3,500	2,000	3	105	3
4	470	D/7343-31	T520D477M004A(3)E025	188	10	25	3,000	2,000	3	105	3
4	470	D/7343-31	T525D477M004A(3)E025	188	10	25	3,000	2,000	3	125	5
4	470	D/7343-31	T520D477M004A(3)E040	188	10	40	2,400	2,000	3	105	3
4	470	D/7343-31	T525D477M004A(3)E040	188	10	40	2,400	2,000	3	125	5
4	470	Y/7343-40	T530Y477M004A(3)E005	188	8	5	7,300	2,000	3	125	5
4	470	Y/7343-40	T530Y477M004A(3)E006	188	8	6	6,600	2,000	3	125	5
4	680	D/7343-31	T520D687M004A(3)E012	272	10	12	4,300	2,000	3	105	3
4	680	D/7343-31	T520D687M004A(3)E015	272	10	15	3,900	2,000	3	105	3
VDC at 105°C	µF	KEMET/EIA	(See below for part options)	µA at 25°C Maximum/ 5 Minutes	% at 25°C 120 Hz Maximum	mΩ at 25°C 100 kHz Maximum	mA at +45°C 100 kHz	(Hours)	Reflow Temp ≤ 260°C	°C	
Rated Voltage	Rated Capacitance	Case Code/Case Size	KEMET Part Number	DC Leakage	DF	ESR	Maximum Allowable Ripple Current	Endurance	MSL	Maximum Operating Temp	Derating Category

(2) To complete KEMET part number, insert M for ±20% or K for ±10%. Designates Capacitance tolerance.

(3) To complete KEMET part number, insert T = 100% Matte Tin (Sn)-plated or H = Standard Solder coated (SnPb 5% Pb minimum). Refer to Ordering Information for additional detail.

Higher voltage ratings and tighter ESR may be substituted within the same size at KEMET's option. Voltage substitutions will be marked with the higher voltage rating. Substitutions can include better than series.

**Part numbers marked in blue font are not recommended for new designs. Please use the T521 series instead.**

^ Denotes the large reel (13") is not available.

\* DF measurement condition is 120 Hz/0.5 V<sub>rms</sub>/1.5 V DC Bias  
Refer to Ordering Information for additional detail.

**Table 1 – Ratings & Part Number Reference cont.**

Rated Voltage VDC at 105°C	Rated Capacitance	Case Code/Case Size	KEMET Part Number	DC Leakage	DF	ESR	Maximum Allowable Ripple Current	Endurance	MSL	Maximum Operating Temperature	Derating Category
Not all parts are 105°C rated	µF	KEMET/EIA	(See below for part options)	µA at 25°C Maximum/ 5 Minutes	% at 25°C 120 Hz Maximum	mΩ at 25°C 100 kHz Maximum	(rms) mA at +45°C 100 kHz	(Hours)	Reflow Temp ≤ 260°C	°C	
4	680	D/7343-31	T520D687M004A(3)E025	272	10	25	3,000	2,000	3	105	3
4	680	Y/7343-40	T530Y687M004A(3)E005	272	8	5	7,300	2,000	3	125	5
4	680	Y/7343-40	T520Y687M004A(3)E010	272	10	10	4,900	2,000	3	105	3
4	680	Y/7343-40	T520Y687M004A(3)E015	272	10	15	4,000	2,000	3	105	3
4	680	Y/7343-40	T520Y687M004A(3)E025	272	10	25	3,100	2,000	3	105	3
4	680	X/7343-43	T530X687M004A(3)E004	272	8	4	8,200	2,000	3	125	5
4	680	X/7343-43	T530X687M004A(3)E005	272	8	5	7,300	2,000	3	125	5
4	680	X/7343-43	T530X687M004A(3)E006	272	8	6	6,700	2,000	3	125	5
4	680	X/7343-43	T520X687M004A(3)E010	272	10	10	5,000	2,000	3	105	3
4	680	X/7343-43	T530X687M004A(3)E010	272	8	10	5,200	2,000	3	125	5
4	680	X/7343-43	T520X687M004A(3)E015	272	10	15	4,100	2,000	3	105	3
4	680	X/7343-43	T520X687M004A(3)E035	272	10	35	2,700	2,000	3	105	3
4	1000	X/7343-43	T530X108M004A(3)E006	400	8	6	6,700	2,000	3	125	5
6.3	15	T/3528-12	T520T156M006A(3)E100	9.45	8	100	1,000	2,000	3	105	3
6.3	10	P/2012-10	T529P106M006AAE200 ^	18.9	6 *	200	354	1,000	3	105	3
6.3	22	P/2012-10	T529P226M006AAE150 ^	22	6 *	150	408	1,000	3	105	3
6.3	22	P/2012-10	T529P226M006AAE200 ^	22	6 *	200	354	1,000	3	105	3
6.3	22	A/3216-18	T520A226M006ATE090 ^	13.86	8 *	90	1,100	2,000	3	105	3
6.3	22	A/3216-18	T520A226M006ATE100 ^	13.86	8 *	100	1,100	2,000	3	105	3
6.3	22	T/3528-12	T520T226M006A(3)E100	13.86	8	100	1,000	2,000	3	105	3
6.3	33	A/3216-18	T520A336M006A(3)E070 ^	20.79	8 *	70	1,300	2,000	3	105	3
6.3	33	A/3216-18	T520A336M006A(3)E080 ^	20.79	8 *	80	1,200	2,000	3	105	3
6.3	33	A/3216-18	T520A336M006A(3)E120 ^	20.79	8 *	120	1,000	2,000	3	105	3
6.3	33	T/3528-12	T520T336M006A(3)E070	20.79	8	70	1,220	2,000	3	105	3
6.3	33	B/3528-21	T520B336M006A(3)E025	20.79	8	25	2,300	2,000	3	105	3
6.3	33	B/3528-21	T520B336M006A(3)E035	20.79	8	35	1,900	2,000	3	105	3
6.3	33	B/3528-21	T520B336M006A(3)E040	20.79	8	40	1,800	2,000	3	105	3
6.3	33	B/3528-21	T520B336M006A(3)E070	20.79	8	70	1,350	2,000	3	105	3
6.3	33	B/3528-21	T525B336M006A(3)E080	20.79	8	80	1,300	2,000	3	125	5
6.3	33	C/6032-28	T520C336M006A(3)E100	20.79	8	100	1,300	2,000	3	105	3
6.3	47	P/2012-10	T529P476M006AAE200 ^	29.61	6 *	200	354	1,000	3	105	4
6.3	47	P/2012-10	T529P476M006AAE150 ^	29.6	6 *	150	408	1,000	3	105	4
6.3	47	3216-08	TF08A476M006APE150 ^	29.6	10 *	150	632	1,000	3	105	3
6.3	47	I/3216-10	T527I476M006ATE200 ^	29.6	6 *	200	548	1,000	3	105	3
6.3	47	A/3216-18	T520A476M006ATE150 ^	29.61	8 *	150	900	2,000	3	105	3
6.3	47	T/3528-12	T520T476M006A(3)E040	29.61	8	40	1,600	2,000	3	105	3
6.3	47	T/3528-12	T520T476M006A(3)E070	29.61	8	70	1,220	2,000	3	105	3
6.3	47	T/3528-12	T525T476M006A(3)E080	29.61	8	80	1,100	2,000	3	125	5
6.3	47	B/3528-21	T520B476M006A(3)E025	29.61	8	25	2,300	2,000	3	105	3
6.3	47	B/3528-21	T520B476M006A(3)E035	29.61	8	35	1,900	2,000	3	105	3
6.3	47	B/3528-21	T520B476M006A(3)E040	29.61	8	40	1,800	2,000	3	105	3
VDC at 105°C	µF	KEMET/EIA	(See below for part options)	µA at 25°C Maximum/ 5 Minutes	% at 25°C 120 Hz Maximum	mΩ at 25°C 100 kHz Maximum	mA at +45°C 100 kHz	(Hours)	Reflow Temp ≤ 260°C	°C	
Rated Voltage	Rated Capacitance	Case Code/Case Size	KEMET Part Number	DC Leakage	DF	ESR	Maximum Allowable Ripple Current	Endurance	MSL	Maximum Operating Temp	Derating Category

(2) To complete KEMET part number, insert M for ±20% or K for ±10%. Designates Capacitance tolerance.

(3) To complete KEMET part number, insert T = 100% Matte Tin (Sn)-plated or H = Standard Solder coated (SnPb 5% Pb minimum). Refer to Ordering Information for additional detail.

Higher voltage ratings and tighter ESR may be substituted within the same size at KEMET's option. Voltage substitutions will be marked with the higher voltage rating. Substitutions can include better than series.

**Part numbers marked in blue font are not recommended for new designs. Please use the T521 series instead.**

^ Denotes the large reel (13") is not available.

\* DF measurement condition is 120 Hz/0.5 V<sub>rms</sub>/1.5 V DC Bias  
Refer to Ordering Information for additional detail.

**Table 1 – Ratings & Part Number Reference cont.**

Rated Voltage VDC at 105°C	Rated Capacitance	Case Code/Case Size	KEMET Part Number	DC Leakage	DF	ESR	Maximum Allowable Ripple Current	Endurance	MSL	Maximum Operating Temperature	Derating Category
Not all parts are 105°C rated	µF	KEMET/EIA	(See below for part options)	µA at 25°C Maximum/ 5 Minutes	% at 25°C 120 Hz Maximum	mΩ at 25°C 100 kHz Maximum	(rms) mA at +45°C 100 kHz	(Hours)	Reflow Temp ≤ 260°C	°C	
6.3	47	B/3528-21	T520B476M006A(3)E070	29.61	8	70	1,350	2,000	3	105	3
6.3	47	B/3528-21	T525B476M006A(3)E070	29.61	8	70	1,300	2,000	3	125	5
6.3	47	B/3528-21	T525B476M006A(3)E080	29.61	8	80	1,300	2,000	3	125	5
6.3	68	A/3216-18	T520A686M006ATE150 ^	42.84	8 *	150	900	2,000	3	105	3
6.3	68	T/3528-12	T520T686M006A(3)E070	42.84	8	70	1,220	2,000	3	105	3
6.3	68	T/3528-12	T520T686M006A(3)E150	42.84	8	150	800	2,000	3	105	3
6.3	68	B/3528-21	T520B686M006A(3)E025	42.84	8	25	2,300	2,000	3	105	3
6.3	68	B/3528-21	T520B686M006A(3)E035	42.84	8	35	1,900	2,000	3	105	3
6.3	68	B/3528-21	T520B686M006A(3)E040	42.84	8	40	1,800	2,000	3	105	3
6.3	68	B/3528-21	T520B686M006A(3)E070	42.84	8	70	1,350	2,000	3	105	3
6.3	68	B/3528-21	T525B686M006A(3)E080	42.84	8	80	1,300	2,000	3	125	5
6.3	68	U/6032-15	T520U686M006A(3)E055	42.84	8	55	1,600	2,000	3	105	3
6.3	68	U/6032-15	T520U686M006A(3)E070	42.84	8	70	1,400	2,000	3	105	3
6.3	68	C/6032-28	T520C686M006A(3)E100	42.84	8	100	1,300	2,000	3	105	3
6.3	100	I/3216-10	T527I107M006ATE200 ^	63.0	8 *	200	775	1,000	3	105	3
6.3	100	I/3216-10	T527I107M006ATE100 ^	63.0	8 *	100	775	1,000	3	105	3
6.3	100	I/3216-10	T527I107M006ATE070 ^	63.0	8 *	70	1,134	1,000	3	105	3
6.3	100	I/3216-10	T527I107M006ATE055 ^	63.0	8 *	55	1,044	1,000	3	105	3
6.3	100	A/3216-18	T520A107M006ATE070 ^	63.0	8 *	70	1,035	2,000	3	105	3
6.3	100	A/3216-18	T520A107M006ATE045 ^	63.0	8 *	45	1,600	2,000	3	105	3
6.3	100	A/3216-18	T520A107M006ATE035 ^	63.0	8 *	35	1,500	2,000	3	105	3
6.3	100	A/3216-18	T520A107M006ATE025 ^	63.0	8 *	25	1,732	2,000	3	105	3
6.3	100	T/3528-12	T520T107M006APE070	63.0	8	70	1,220	2,000	3	105	3
6.3	100	T/3528-12	T520T107M006APE055	63.0	8	55	1,200	2,000	3	105	3
6.3	100	B/3528-21	T520B107M006A(3)E015	63.0	8	15	2,900	2,000	3	105	3
6.3	100	B/3528-21	T520B107M006A(3)E018	63.0	8	18	2,700	2,000	3	105	3
6.3	100	B/3528-21	T520B107M006A(3)E025	63.0	8	25	2,300	2,000	3	105	3
6.3	100	B/3528-21	T520B107M006A(3)E035	63.0	8	35	1,900	2,000	3	105	3
6.3	100	B/3528-21	T520B107M006A(3)E040	63.0	8	40	1,800	2,000	3	105	3
6.3	100	B/3528-21	T520B107M006A(3)E045	63.0	8	45	1,700	2,000	3	105	3
6.3	100	B/3528-21	T520B107M006A(3)E070	63.0	8	70	1,350	2,000	3	105	3
6.3	100	U/6032-15	T520U107M006A(3)E055	63.0	8	55	1,600	2,000	3	105	3
6.3	100	W/7343-15	T520W107M006A(3)E040	63.0	10	40	2,100	2,000	3	105	3
6.3	100	V/7343-19	T520V107M006A(3)E007	63.0	10	7	5,170	2,000	3	105	3
6.3	100	V/7343-19	T520V107M006A(3)E009	63.0	10	9	4,600	2,000	3	105	3
6.3	100	V/7343-19	T520V107M006A(3)E012	63.0	10	12	3,900	2,000	3	105	3
6.3	100	V/7343-19	T520V107M006A(3)E015	63.0	10	15	3,500	2,000	3	105	3
6.3	100	V/7343-19	T520V107M006A(3)E045	63.0	10	45	2,000	2,000	3	105	3
6.3	100	C/6032-28	T520C107M006A(3)E025	63.0	8	25	2,600	2,000	3	105	3
6.3	100	C/6032-28	T520C107M006A(3)E045	63.0	8	45	1,900	2,000	3	105	3
6.3	120	B/3528-21	T520B127M006A(3)E035	75.6	8	35	1,900	2,000	3	105	3
VDC at 105°C	µF	KEMET/EIA	(See below for part options)	µA at 25°C Maximum/ 5 Minutes	% at 25°C 120 Hz Maximum	mΩ at 25°C 100 kHz Maximum	mA at +45°C 100 kHz	(Hours)	Reflow Temp ≤ 260°C	°C	
Rated Voltage	Rated Capacitance	Case Code/Case Size	KEMET Part Number	DC Leakage	DF	ESR	Maximum Allowable Ripple Current	Endurance	MSL	Maximum Operating Temp	Derating Category

(2) To complete KEMET part number, insert M for ±20% or K for ±10%. Designates Capacitance tolerance.

(3) To complete KEMET part number, insert T = 100% Matte Tin (Sn)-plated or H = Standard Solder coated (SnPb 5% Pb minimum). Refer to Ordering Information for additional detail.

Higher voltage ratings and tighter ESR may be substituted within the same size at KEMET's option. Voltage substitutions will be marked with the higher voltage rating. Substitutions can include better than series.

**Part numbers marked in blue font are not recommended for new designs. Please use the T521 series instead.**

^ Denotes the large reel (13") is not available.

\* DF measurement condition is 120 Hz/0.5 V<sub>rms</sub>/1.5 V DC Bias  
Refer to Ordering Information for additional detail.

**Table 1 – Ratings & Part Number Reference cont.**

Rated Voltage VDC at 105°C	Rated Capacitance	Case Code/ Case Size	KEMET Part Number	DC Leakage	DF	ESR	Maximum Allowable Ripple Current	Endurance	MSL	Maximum Operating Temperature	Derating Category
Not all parts are 105°C rated	µF	KEMET/EIA	(See below for part options)	µA at 25°C Maximum/ 5 Minutes	% at 25°C 120 Hz Maximum	mΩ at 25°C 100 kHz Maximum	(rms) mA at +45°C 100 kHz	(Hours)	Reflow Temp ≤ 260°C	°C	
6.3	150	M/3528-15	T520M157M006A(3)E035	94.5	8	35	1,900	2,000	3	105	3
6.3	150	M/3528-15	T520M157M006A(3)E070	94.5	8	70	1,310	2,000	3	105	3
6.3	150	M/3528-15	T520M157M006A(3)E150	94.5	8	150	900	2,000	3	105	3
6.3	150	M/3528-15	T520M157M006A(3)E200	94.5	8	200	800	2,000	3	105	3
6.3	150	B/3528-21	T520B157M006A(3)E018	94.5	9	18	2,700	2,000	3	105	3
6.3	150	B/3528-21	T520B157M006A(3)E025	94.5	8	25	2,300	2,000	3	105	3
6.3	150	B/3528-21	T520B157M006A(3)E035	94.5	8	35	1,900	2,000	3	105	3
6.3	150	B/3528-21	T520B157M006A(3)E045	94.5	8	45	1,700	2,000	3	105	3
6.3	150	B/3528-21	T520B157M006A(3)E070	94.5	8	70	1,300	2,000	3	105	3
6.3	150	T/3528-12	T523T157M006APE030	94.5	8	30	1,870	2,000	3	105	3
6.3	150	T/3528-12	T520T157M006ATE035 ^	94.5	8 *	35	1,700	2,000	3	105	3
6.3	150	C/6032-28	T520C157M006A(3)E015	94.5	8	15	3,300	2,000	3	105	3
6.3	150	C/6032-28	T520C157M006A(3)E025	94.5	8	25	2,600	2,000	3	105	3
6.3	150	C/6032-28	T520C157M006A(3)E045	94.5	8	45	1,900	2,000	3	105	3
6.3	150	C/6032-28	T520C157M006A(3)E055	94.5	8	55	1,700	2,000	3	105	3
6.3	150	U/6032-15	T520U157M006A(3)E045	94.5	8	45	1,700	2,000	3	105	3
6.3	150	U/6032-15	T520U157M006A(3)E055	94.5	8	55	1,600	2,000	3	105	3
6.3	150	L/6032-19	T520L157M006A(3)E012	94.5	8	12	3,500	2,000	3	105	3
6.3	150	L/6032-19	T520L157M006A(3)E025	94.5	8	25	2,400	2,000	3	105	3
6.3	150	W/7343-15	T520W157M006A(3)E025	94.5	10	25	2,700	2,000	3	105	3
6.3	150	W/7343-15	T520W157M006A(3)E040	94.5	10	40	2,100	2,000	3	105	3
6.3	150	V/7343-19	T520V157M006A(3)E006	94.5	10	6	5,600	2,000	3	105	3
6.3	150	V/7343-19	T520V157M006A(3)E007	94.5	10	7	5,200	2,000	3	105	3
6.3	150	V/7343-19	T520V157M006A(3)E009	94.5	10	9	4,600	2,000	3	105	3
6.3	150	V/7343-19	T520V157M006A(3)E012	94.5	10	12	3,900	2,000	3	105	3
6.3	150	V/7343-19	T520V157M006A(3)E015	94.5	10	15	3,500	2,000	3	105	3
6.3	150	V/7343-19	T520V157M006A(3)E018	94.5	10	18	3,200	2,000	3	105	3
6.3	150	V/7343-19	T520V157M006A(3)E025	94.5	10	25	2,700	2,000	3	105	3
6.3	150	V/7343-19	T520V157M006A(3)E040	94.5	10	40	2,200	2,000	3	105	3
6.3	150	V/7343-19	T520V157M006A(3)E045	94.5	10	45	2,000	2,000	3	105	3
6.3	150	D/7343-31	T520D157M006A(3)E006	94.5	10	6	6,100	2,000	3	105	3
6.3	150	D/7343-31	T520D157M006A(3)E007	94.5	10	7	5,700	2,000	3	105	3
6.3	150	D/7343-31	T520D157M006A(3)E015	94.5	10	15	3,900	2,000	3	105	3
6.3	150	D/7343-31	T520D157M006A(3)E025	94.5	10	25	3,000	2,000	3	105	3
6.3	150	D/7343-31	T525D157M006A(3)E025	94.5	10	25	3,000	2,000	3	125	5
6.3	150	D/7343-31	T520D157M006A(3)E055	94.5	10	55	2,000	2,000	3	105	3
6.3	220	M/3528-15	T520M227M006ATE035 ^	138.6	10 *	35	1,512	2,000	3	105	3
6.3	220	B/3528-21	T520B227M006A(3)E025	138.6	8	25	2,300	2,000	3	105	3
6.3	220	B/3528-21	T520B227M006A(3)E035	138.6	8	35	1,900	2,000	3	105	3
6.3	220	B/3528-21	T520B227M006A(3)E045	138.6	8	45	1,700	2,000	3	105	3
6.3	220	B/3528-21	T520B227M006A(3)E070	138.6	8	70	1,300	2,000	3	105	3
VDC at 105°C	µF	KEMET/EIA	(See below for part options)	µA at 25°C Maximum/ 5 Minutes	% at 25°C 120 Hz Maximum	mΩ at 25°C 100 kHz Maximum	mA at +45°C 100 kHz	(Hours)	Reflow Temp ≤ 260°C	°C	
Rated Voltage	Rated Capacitance	Case Code/ Case Size	KEMET Part Number	DC Leakage	DF	ESR	Maximum Allowable Ripple Current	Endurance	MSL	Maximum Operating Temp	Derating Category

(2) To complete KEMET part number, insert M for ±20% or K for ±10%. Designates Capacitance tolerance.

(3) To complete KEMET part number, insert T = 100% Matte Tin (Sn)-plated or H = Standard Solder coated (SnPb 5% Pb minimum). Refer to Ordering Information for additional detail.

Higher voltage ratings and tighter ESR may be substituted within the same size at KEMET's option. Voltage substitutions will be marked with the higher voltage rating. Substitutions can include better than series.

**Part numbers marked in blue font are not recommended for new designs. Please use the T521 series instead.**

^ Denotes the large reel (13") is not available.

\* DF measurement condition is 120 Hz/0.5 V<sub>rms</sub>/1.5 V DC Bias  
Refer to Ordering Information for additional detail.

**Table 1 – Ratings & Part Number Reference cont.**

Rated Voltage VDC at 105°C	Rated Capacitance	Case Code/Case Size	KEMET Part Number	DC Leakage	DF	ESR	Maximum Allowable Ripple Current	Endurance	MSL	Maximum Operating Temperature	Derating Category
Not all parts are 105°C rated	µF	KEMET/EIA	(See below for part options)	µA at 25°C Maximum/ 5 Minutes	% at 25°C 120 Hz Maximum	mΩ at 25°C 100 kHz Maximum	(rms) mA at +45°C 100 kHz	(Hours)	Reflow Temp ≤ 260°C	°C	
6.3	220	C/6032-28	T520C227M006A(3)E015	138.6	8	15	3,300	2,000	3	105	3
6.3	220	C/6032-28	T520C227M006A(3)E018	138.6	8	18	3,000	2,000	3	105	3
6.3	220	C/6032-28	T520C227M006A(3)E025	138.6	8	25	2,600	2,000	3	105	3
6.3	220	C/6032-28	T520C227M006A(3)E045	138.6	8	45	1,900	2,000	3	105	3
6.3	220	V/7343-19	T520V227M006A(3)E007	138.6	10	7	5,200	2,000	3	105	3
6.3	220	V/7343-19	T520V227M006A(3)E009	138.6	10	9	4,600	2,000	3	105	3
6.3	220	V/7343-19	T520V227M006A(3)E012	138.6	10	12	3,900	2,000	3	105	3
6.3	220	V/7343-19	T520V227M006A(3)E015	138.6	10	15	3,500	2,000	3	105	3
6.3	220	V/7343-19	T520V227M006A(3)E018	138.6	10	18	3,200	2,000	3	105	3
6.3	220	V/7343-19	T520V227M006A(3)E025	138.6	10	25	2,700	2,000	3	105	3
6.3	220	V/7343-19	T520V227M006A(3)E040	138.6	10	40	2,200	2,000	3	105	3
6.3	220	D/7343-31	T530D227M006A(3)E005	138.6	8	5	7,100	2,000	3	125	5
6.3	220	D/7343-31	T520D227M006A(3)E006	138.6	10	6	6,100	2,000	3	105	3
6.3	220	D/7343-31	T530D227M006A(3)E006	138.6	8	6	6,500	2,000	3	125	5
6.3	220	D/7343-31	T520D227M006A(3)E007	138.6	10	7	5,700	2,000	3	105	3
6.3	220	D/7343-31	T520D227M006A(3)E009	138.6	10	9	5,000	2,000	3	105	3
6.3	220	D/7343-31	T520D227M006A(3)E015	138.6	10	15	3,900	2,000	3	105	3
6.3	220	D/7343-31	T520D227M006A(3)E018	138.6	10	18	3,500	2,000	3	105	3
6.3	220	D/7343-31	T520D227M006A(3)E025	138.6	10	25	3,000	2,000	3	105	3
6.3	220	D/7343-31	T525D227M006A(3)E025	138.6	10	25	3,000	2,000	3	125	5
6.3	220	D/7343-31	T520D227M006A(3)E040	138.6	10	40	2,400	2,000	3	105	3
6.3	220	D/7343-31	T520D227M006A(3)E050	138.6	10	50	2,100	2,000	3	105	3
6.3	330	B/3528-21	T520B337M006A(3)E040	207.9	8	40	1,800	2,000	3	105	3
6.3	330	B/3528-21	T520B337M006ATE045 ^	415.8	10 *	45	1,374	2,000	3	85	1
6.3	330	B/3528-21	T520B337M006A(3)E070	207.9	8	70	1,350	2,000	3	105	3
6.3	330	V/7343-19	T520V337M006A(3)E015	207.9	10	15	3,500	2,000	3	105	3
6.3	330	V/7343-19	T520V337M006A(3)E018	207.9	10	18	3,200	2,000	3	105	3
6.3	330	V/7343-19	T520V337M006A(3)E025	207.9	10	25	2,700	2,000	3	105	3
6.3	330	V/7343-19	T520V337M006A(3)E040	207.9	10	40	2,200	2,000	3	105	3
6.3	330	V/7343-19	T520V337M006A(3)E045	207.9	10	45	2,000	2,000	3	105	3
6.3	330	D/7343-31	T530D337M006A(3)E006	207.9	8	6	6,500	2,000	3	125	5
6.3	330	D/7343-31	T520D337M006A(3)E009	207.9	10	9	5,000	2,000	3	105	3
6.3	330	D/7343-31	T520D337M006A(3)E010	207.9	10	10	4,700	2,000	3	105	3
6.3	330	D/7343-31	T530D337M006A(3)E010	207.9	8	10	5,000	2,000	3	125	5
6.3	330	D/7343-31	T520D337M006A(3)E015	207.9	10	15	3,900	2,000	3	105	3
6.3	330	D/7343-31	T520D337M006A(3)E018	207.9	10	18	3,500	2,000	3	105	3
6.3	330	D/7343-31	T520D337M006A(3)E025	207.9	10	25	3,000	2,000	3	105	3
6.3	330	D/7343-31	T525D337M006A(3)E025	207.9	10	25	3,000	2,000	3	125	5
6.3	330	D/7343-31	T520D337M006A(3)E040	207.9	10	40	2,400	2,000	3	105	3
6.3	330	D/7343-31	T525D337M006A(3)E040	207.9	10	40	2,400	2,000	3	125	5
6.3	330	D/7343-31	T520D337M006A(3)E045	207.9	10	45	2,200	2,000	3	105	3
VDC at 105°C	µF	KEMET/EIA	(See below for part options)	µA at 25°C Maximum/ 5 Minutes	% at 25°C 120 Hz Maximum	mΩ at 25°C 100 kHz Maximum	mA at +45°C 100 kHz	(Hours)	Reflow Temp ≤ 260°C	°C	
Rated Voltage	Rated Capacitance	Case Code/Case Size	KEMET Part Number	DC Leakage	DF	ESR	Maximum Allowable Ripple Current	Endurance	MSL	Maximum Operating Temp	Derating Category

(2) To complete KEMET part number, insert M for ±20% or K for ±10%. Designates Capacitance tolerance.

(3) To complete KEMET part number, insert T = 100% Matte Tin (Sn)-plated or H = Standard Solder coated (SnPb 5% Pb minimum). Refer to Ordering Information for additional detail.

Higher voltage ratings and tighter ESR may be substituted within the same size at KEMET's option. Voltage substitutions will be marked with the higher voltage rating. Substitutions can include better than series.

**Part numbers marked in blue font are not recommended for new designs. Please use the T521 series instead.**

^ Denotes the large reel (13") is not available.

\* DF measurement condition is 120 Hz/0.5 V<sub>rms</sub>/1.5 V DC Bias  
Refer to Ordering Information for additional detail.

**Table 1 – Ratings & Part Number Reference cont.**

Rated Voltage VDC at 105°C	Rated Capacitance	Case Code/Case Size	KEMET Part Number	DC Leakage	DF	ESR	Maximum Allowable Ripple Current	Endurance	MSL	Maximum Operating Temperature	Derating Category
Not all parts are 105°C rated	µF	KEMET/EIA	(See below for part options)	µA at 25°C Maximum/ 5 Minutes	% at 25°C 120 Hz Maximum	mΩ at 25°C 100 kHz Maximum	(rms) mA at +45°C 100 kHz	(Hours)	Reflow Temp ≤ 260°C	°C	
6.3	330	Y/7343-40	T530Y337M006A(3)E005	207.9	8	5	7,300	2,000	3	125	5
6.3	330	Y/7343-40	T530Y337M006A(3)E006	207.9	8	6	6,600	2,000	3	125	5
6.3	330	Y/7343-40	T520Y337M006A(3)E010	207.9	10	10	4,900	2,000	3	105	3
6.3	330	Y/7343-40	T530Y337M006A(3)E010	207.9	8	10	5,100	2,000	3	125	5
6.3	330	Y/7343-40	T520Y337M006A(3)E015	207.9	10	15	4,000	2,000	3	105	3
6.3	330	Y/7343-40	T520Y337M006A(3)E025	207.9	10	25	3,100	2,000	3	105	3
6.3	330	Y/7343-40	T520Y337M006A(3)E040	207.9	10	40	2,500	2,000	3	105	3
6.3	470	W/7343-15	T520W477M006A(3)E055	296.1	10	55	1,800	2,000	3	85	1
6.3	470	W/7343-15	T520W477M006A(3)E035	296.1	9	35	2,300	2,000	3	85	1
6.3	470	V/7343-19	T520V477M006A(3)E055	296.1	10	55	1,800	2,000	3	105	3
6.3	470	V/7343-19	T520V477M006A(3)E035	296.1	10	35	2,300	2,000	3	105	3
6.3	470	Y/7343-40	T530Y477M006A(3)E005	296.1	8	5	7,300	2,000	3	125	5
6.3	470	Y/7343-40	T520Y477M006A(3)E010	296.1	10	10	4,900	2,000	3	105	3
6.3	470	Y/7343-40	T520Y477M006A(3)E015	296.1	10	15	4,000	2,000	3	105	3
6.3	470	Y/7343-40	T520Y477M006A(3)E018	296.1	10	18	3,700	2,000	3	105	3
6.3	470	Y/7343-40	T520Y477M006A(3)E025	296.1	10	25	3,100	2,000	3	105	3
6.3	470	Y/7343-40	T520Y477M006A(3)E035	296.1	10	35	2,600	2,000	3	105	3
6.3	470	Y/7343-40	T525Y477M006A(3)E035	296.1	10	35	2,600	2,000	3	125	5
6.3	470	D/7343-31	T520D477M006A(3)E015	296.1	10	15	3,900	2,000	3	105	3
6.3	470	D/7343-31	T520D477(2)006A(3)E025	296.1	10	25	3,000	2,000	3	105	3
6.3	470	D/7343-31	T520D477M006A(3)E030	296.1	10	30	2,700	2,000	3	105	3
6.3	470	X/7343-43	T530X477M006A(3)E004	296.1	8	4	8,200	2,000	3	125	5
6.3	470	X/7343-43	T530X477M006A(3)E005	296.1	8	5	7,300	2,000	3	125	5
6.3	470	X/7343-43	T530X477M006A(3)E006	296.1	8	6	6,700	2,000	3	125	5
6.3	470	X/7343-43	T520X477M006A(3)E010	296.1	10	10	5,000	2,000	3	105	3
6.3	470	X/7343-43	T530X477M006A(3)E010	296.1	8	10	5,200	2,000	3	125	5
6.3	470	X/7343-43	T520X477M006A(3)E018	296.1	10	18	3,700	2,000	3	105	3
6.3	470	X/7343-43	T520X477M006A(3)E035	296.1	10	35	2,700	2,000	3	105	3
6.3	470	X/7343-43	T520X477M006A(3)E040	296.1	10	40	2,500	2,000	3	105	3
6.3	680	V/7343-19	T520V687M006A(3)E025	428.4	10	25	3,100	2,000	3	105	3
6.3	680	V/7343-19	T520V687M006A(3)E035	428.4	10	35	2,300	2,000	3	105	3
6.3	680	Y/7343-40	T520Y687M006A(3)E018	428.4	10	18	3,700	2,000	3	105	3
6.3	680	Y/7343-40	T520Y687M006A(3)E025	428.4	10	25	3,100	2,000	3	105	3
6.3	680	X/7343-43	T530X687M006A(3)E010	428.4	8	10	5,200	2,000	3	125	5
6.3	680	X/7343-43	T530X687M006A(3)E018	428.4	8	18	3,900	2,000	3	125	5
6.3	680	X/7343-43	T520X687M006A(3)E025	428.4	10	25	3,100	2,000	3	105	3
6.3	680	X/7343-43	T520X687M006A(3)E018	428.0	10	18	3,700	2,000	3	105	3
6.3	680	J/7360-15	T523J687M006APE070	428.0	10	70	2,510	2,000	3	85	1
6.3	1000	H/7360-20	T520H108M006A(3)E055	630.0	20	55	1,800	2,000	3	85	1
6.3	1200	H/7360-20	T520H128M006A(3)E070	756.0	20	70	1,200	2,000	3	85	1
6.3	1500	H/7360-20	T520H158M006A(3)E055	945.0	20	55	1,800	2,000	3	85	1
VDC at 105°C	µF	KEMET/EIA	(See below for part options)	µA at 25°C Maximum/ 5 Minutes	% at 25°C 120 Hz Maximum	mΩ at 25°C 100 kHz Maximum	mA at +45°C 100 kHz	(Hours)	Reflow Temp ≤ 260°C	°C	
Rated Voltage	Rated Capacitance	Case Code/Case Size	KEMET Part Number	DC Leakage	DF	ESR	Maximum Allowable Ripple Current	Endurance	MSL	Maximum Operating Temp	Derating Category

(2) To complete KEMET part number, insert M for ±20% or K for ±10%. Designates Capacitance tolerance.

(3) To complete KEMET part number, insert T = 100% Matte Tin (Sn)-plated or H = Standard Solder coated (SnPb 5% Pb minimum). Refer to Ordering Information for additional detail.

Higher voltage ratings and tighter ESR may be substituted within the same size at KEMET's option. Voltage substitutions will be marked with the higher voltage rating. Substitutions can include better than series.

**Part numbers marked in blue font are not recommended for new designs. Please use the T521 series instead.**

^ Denotes the large reel (13") is not available.

\* DF measurement condition is 120 Hz/0.5 V<sub>rms</sub>/1.5 V DC Bias  
Refer to Ordering Information for additional detail.

**Table 1 – Ratings & Part Number Reference cont.**

Rated Voltage VDC at 105°C	Rated Capacitance	Case Code/Case Size	KEMET Part Number	DC Leakage	DF	ESR	Maximum Allowable Ripple Current	Endurance	MSL	Maximum Operating Temperature	Derating Category
Not all parts are 105°C rated	µF	KEMET/EIA	(See below for part options)	µA at 25°C Maximum/ 5 Minutes	% at 25°C 120 Hz Maximum	mΩ at 25°C 100 kHz Maximum	(rms) mA at +45°C 100 kHz	(Hours)	Reflow Temp ≤ 260°C	°C	
8	22	T/3528-12	T520T226M008A(3)E070	17.6	8	70	1,220	2,000	3	105	3
8	33	T/3528-12	T520T336M008A(3)E070	26.4	8	70	1,220	2,000	3	105	3
8	33	T/3528-12	T520T336M008A(3)E080	26.4	8	80	1,100	2,000	3	105	3
8	33	T/3528-12	T525T336M008A(3)E080	26.4	8	80	1,100	2,000	3	125	5
8	33	B/3528-21	T520B336M008A(3)E025	26.4	8	25	2,300	2,000	3	105	3
8	33	B/3528-21	T520B336M008A(3)E035	26.4	8	35	1,900	2,000	3	105	3
8	33	B/3528-21	T520B336M008A(3)E040	26.4	8	40	1,800	2,000	3	105	3
8	33	B/3528-21	T520B336M008A(3)E070	26.4	8	70	1,350	2,000	3	105	3
8	33	U/6032-15	T520U336M008A(3)E070	26.4	8	70	1,400	2,000	3	105	3
8	47	B/3528-21	T520B476M008A(3)E035	37.6	8	35	1,900	2,000	3	105	3
8	47	B/3528-21	T520B476M008A(3)E070	37.6	8	70	1,350	2,000	3	105	3
8	82	C/6032-28	T520C826M008A(3)E025	65.6	8	25	2,600	2,000	3	105	3
8	82	C/6032-28	T520C826M008A(3)E045	65.6	8	45	1,900	2,000	3	105	3
8	150	D/7343-31	T520D157M008A(3)E025	120	10	25	3,000	2,000	3	105	3
8	150	D/7343-31	T520D157M008A(3)E040	120	10	40	2,400	2,000	3	105	3
8	150	D/7343-31	T520D157M008A(3)E055	120	10	55	2,000	2,000	3	105	3
8	150	V/7343-19	T520V157M008A(3)E040	120	10	40	2,200	2,000	3	105	3
10	10	P/2012-10	T529P106M010AAE200 ^	30	6 *	200	354	1,000	3	105	3
10	10	A/3216-18	T520A106M010ATE080 ^	10	8 *	80	1,200	2,000	3	105	3
10	10	A/3216-18	T525A106M010A(3)E080	10	8	80	1,200	2,000	3	125	5
10	15	A/3216-18	T520A156M010ATE080 ^	15	8 *	80	1,200	2,000	3	105	3
10	22	P/2012-10	T529P226M010AAE150 ^	66	6 *	150	408	1,000	3	105	3
10	22	P/2012-10	T529P226M010AAE200 ^	66	6 *	200	354	1,000	3	105	3
10	22	I/3216-10	T527I226M010ATE200 ^	22	8 *	200	548	1,000	3	105	3
10	22	A/3216-18	T520A226M010A(3)E080 ^	22	8 *	80	1,200	2,000	3	105	3
10	22	B/3528-21	T525B226M010A(3)E080	22	8	80	1,300	2,000	3	125	5
10	33	I/3216-10	T527I336M010ATE200 ^	33	6 *	200	548	1,000	3	105	3
10	33	T/3528-12	T520T336M010A(3)E040	33	8	40	1,600	2,000	3	105	3
10	33	T/3528-12	T520T336M010A(3)E070	33	8	70	1,220	2,000	3	105	3
10	33	T/3528-12	T520T336M010A(3)E080	33	8	80	1,100	2,000	3	105	3
10	33	T/3528-12	T525T336M010A(3)E080	33	8	80	1,100	2,000	3	125	5
10	33	B/3528-21	T520B336M010A(3)E025	33	8	25	2,300	2,000	3	105	3
10	33	B/3528-21	T520B336M010A(3)E035	33	8	35	1,900	2,000	3	105	3
10	33	B/3528-21	T520B336M010A(3)E040	33	8	40	1,800	2,000	3	105	3
10	33	B/3528-21	T520B336M010A(3)E070	33	8	70	1,350	2,000	3	105	3
10	33	B/3528-21	T525B336M010A(3)E080	33	8	80	1,300	2,000	3	125	5
10	33	U/6032-15	T520U336M010A(3)E070	33	8	70	1,400	2,000	3	105	3
10	47	I/3216-10	T527I476M010ATE200 ^	47	6 *	200	548	1,000	3	105	3
10	47	A/3216-18	T520A476M010ATE045 ^	47	8 *	45	1,291	2,000	3	105	3
10	47	B/3528-21	T520B476M010A(3)E035	47	8	35	1,900	2,000	3	105	3
10	47	B/3528-21	T520B476M010A(3)E070	47	8	70	1,350	2,000	3	105	3
VDC at 105°C	µF	KEMET/EIA	(See below for part options)	µA at 25°C Maximum/ 5 Minutes	% at 25°C 120 Hz Maximum	mΩ at 25°C 100 kHz Maximum	mA at +45°C 100 kHz	(Hours)	Reflow Temp ≤ 260°C	°C	
Rated Voltage	Rated Capacitance	Case Code/Case Size	KEMET Part Number	DC Leakage	DF	ESR	Maximum Allowable Ripple Current	Endurance	MSL	Maximum Operating Temp	Derating Category

(2) To complete KEMET part number, insert M for ±20% or K for ±10%. Designates Capacitance tolerance.

(3) To complete KEMET part number, insert T = 100% Matte Tin (Sn)-plated or H = Standard Solder coated (SnPb 5% Pb minimum). Refer to Ordering Information for additional detail.

Higher voltage ratings and tighter ESR may be substituted within the same size at KEMET's option. Voltage substitutions will be marked with the higher voltage rating. Substitutions can include better than series.

**Part numbers marked in blue font are not recommended for new designs. Please use the T521 series instead.**

^ Denotes the large reel (13") is not available.

\* DF measurement condition is 120 Hz/0.5 V<sub>rms</sub>/1.5 V DC Bias  
Refer to Ordering Information for additional detail.

**Table 1 – Ratings & Part Number Reference cont.**

Rated Voltage VDC at 105°C	Rated Capacitance	Case Code/ Case Size	KEMET Part Number	DC Leakage	DF	ESR	Maximum Allowable Ripple Current	Endurance	MSL	Maximum Operating Temperature	Derating Category
Not all parts are 105°C rated	µF	KEMET/EIA	(See below for part options)	µA at 25°C Maximum/ 5 Minutes	% at 25°C 120 Hz Maximum	mΩ at 25°C 100 kHz Maximum	(rms) mA at +45°C 100 kHz	(Hours)	Reflow Temp ≤ 260°C	°C	
10	47	U/6032-15	T520U476M010A(3)E055	47	8	55	1,600	2,000	3	105	3
10	47	C/6032-28	T520C476M010A(3)E100	47	8	100	1,300	2,000	3	105	3
10	68	U/6032-15	T520U686M010A(3)E055	68	8	55	1,600	2,000	3	105	3
10	68	W/7343-15	T520W686M010A(3)E025	68	10	25	2,700	2,000	3	105	3
10	68	W/7343-15	T520W686M010A(3)E040	68	10	40	2,100	2,000	3	105	3
10	68	C/6032-28	T520C686M010A(3)E045	68	8	45	1,900	2,000	3	105	3
10	68	V/7343-19	T520V686M010A(3)E025	68	10	25	2,700	2,000	3	105	3
10	68	V/7343-19	T520V686M010A(3)E040	68	10	40	2,200	2,000	3	105	3
10	68	V/7343-19	T520V686M010A(3)E045	68	10	45	2,000	2,000	3	105	3
10	68	V/7343-19	T520V686M010A(3)E060	68	10	60	1,800	2,000	3	105	3
10	68	V/7343-19	T520V686M010A(3)E100	68	10	100	1,400	2,000	3	105	3
10	68	D/7343-31	T520D686M010A(3)E100	68	10	100	1,500	2,000	3	105	3
10	100	B/3528-21	T520B107M010ATE070 ^	100	8 *	70	1,300	2,000	3	105	3
10	100	C/6032-28	T520C107M010A(3)E025	100	8	25	2,600	2,000	3	105	3
10	100	C/6032-28	T520C107M010A(3)E045	100	8	45	1,900	2,000	3	105	3
10	100	L/6032-19	T520L107M010A(3)E025	100	8	25	2,400	2,000	3	105	3
10	100	W/7343-15	T520W107M010A(3)E040	100	10	40	2,100	2,000	3	105	3
10	100	V/7343-19	T520V107M010A(3)E018	100	10	18	3,200	2,000	3	105	3
10	100	V/7343-19	T520V107M010A(3)E025	100	10	25	2,700	2,000	3	105	3
10	100	V/7343-19	T520V107M010A(3)E045	100	10	45	2,000	2,000	3	105	3
10	100	V/7343-19	T520V107M010A(3)E050	100	10	50	1,900	2,000	3	105	3
10	100	V/7343-19	T520V107M010A(3)E055	100	10	55	1,800	2,000	3	105	3
10	100	D/7343-31	T520D107M010A(3)E018	100	10	18	3,500	2,000	3	105	3
10	100	D/7343-31	T525D107M010A(3)E025	100	10	25	3,000	2,000	3	125	5
10	100	D/7343-31	T520D107M010A(3)E055	100	10	55	2,000	2,000	3	105	3
10	100	D/7343-31	T525D107M010A(3)E055	100	10	55	2,000	2,000	3	125	5
10	100	D/7343-31	T520D107M010A(3)E080	100	10	80	1,700	2,000	3	105	3
10	150	C/6032-28	T520C157M010A(3)E055	150	8	55	1,700	2,000	3	105	3
10	150	V/7343-19	T520V157M010A(3)E018	150	10	18	3,200	2,000	3	105	3
10	150	V/7343-19	T520V157M010A(3)E025	150	10	25	2,700	2,000	3	105	3
10	150	V/7343-19	T520V157M010A(3)E040	150	10	40	2,200	2,000	3	105	3
10	150	D/7343-31	T530D157M010A(3)E005	150	8	5	7,100	2,000	3	125	5
10	150	D/7343-31	T530D157M010A(3)E006	150	8	6	6,500	2,000	3	125	5
10	150	D/7343-31	T530D157M010A(3)E010	150	8	10	5,000	2,000	3	125	5
10	150	D/7343-31	T520D157M010A(3)E015	150	10	15	3,900	2,000	3	105	3
10	150	D/7343-31	T520D157M010A(3)E018	150	10	18	3,500	2,000	3	105	3
10	150	D/7343-31	T520D157M010A(3)E025	150	10	25	3,000	2,000	3	105	3
10	150	D/7343-31	T525D157M010A(3)E025	150	10	25	3,000	2,000	3	125	5
10	150	D/7343-31	T520D157M010A(3)E040	150	10	40	2,400	2,000	3	105	3
10	150	D/7343-31	T520D157M010A(3)E055	150	10	55	2,000	2,000	3	105	3
10	150	D/7343-31	T525D157M010A(3)E055	150	10	55	2,000	2,000	3	125	5
VDC at 105°C	µF	KEMET/EIA	(See below for part options)	µA at 25°C Maximum/ 5 Minutes	% at 25°C 120 Hz Maximum	mΩ at 25°C 100 kHz Maximum	mA at +45°C 100 kHz	(Hours)	Reflow Temp ≤ 260°C	°C	
Rated Voltage	Rated Capacitance	Case Code/ Case Size	KEMET Part Number	DC Leakage	DF	ESR	Maximum Allowable Ripple Current	Endurance	MSL	Maximum Operating Temp	Derating Category

(2) To complete KEMET part number, insert M for ±20% or K for ±10%. Designates Capacitance tolerance.

(3) To complete KEMET part number, insert T = 100% Matte Tin (Sn)-plated or H = Standard Solder coated (SnPb 5% Pb minimum). Refer to Ordering Information for additional detail.

Higher voltage ratings and tighter ESR may be substituted within the same size at KEMET's option. Voltage substitutions will be marked with the higher voltage rating. Substitutions can include better than series.

**Part numbers marked in blue font are not recommended for new designs. Please use the T521 series instead.**

^ Denotes the large reel (13") is not available.

\* DF measurement condition is 120 Hz/0.5 V<sub>rms</sub>/1.5 V DC Bias  
Refer to Ordering Information for additional detail.

**Table 1 – Ratings & Part Number Reference cont.**

Rated Voltage VDC at 105°C	Rated Capacitance	Case Code/Case Size	KEMET Part Number	DC Leakage	DF	ESR	Maximum Allowable Ripple Current	Endurance	MSL	Maximum Operating Temperature	Derating Category
Not all parts are 105°C rated	µF	KEMET/EIA	(See below for part options)	µA at 25°C Maximum/ 5 Minutes	% at 25°C 120 Hz Maximum	mΩ at 25°C 100 kHz Maximum	(rms) mA at +45°C 100 kHz	(Hours)	Reflow Temp ≤ 260°C	°C	
10	150	Y/7343-40	T520Y157M010A(3)E015	150	10	15	4,000	2,000	3	105	3
10	150	Y/7343-40	T520Y157M010A(3)E018	150	10	18	3,700	2,000	3	105	3
10	150	Y/7343-40	T520Y157M010A(3)E025	150	10	25	3,100	2,000	3	105	3
10	220	V/7343-19	T520V227M010A(3)E040	220	10	40	2,200	2,000	3	105	3
10	220	V/7343-19	T520V227M010A(3)E045	220	10	45	2,000	2,000	3	105	3
10	220	V/7343-19	T520V227M010A(3)E025	220	10	25	2,700	2,000	3	105	3
10	220	D/7343-31	T530D227M010A(3)E006	220	8	6	6,500	2,000	3	125	5
10	220	D/7343-31	T530D227M010A(3)E010	220	8	10	5,000	2,000	3	125	5
10	220	D/7343-31	T520D227M010A(3)E018	220	10	18	3,500	2,000	3	105	3
10	220	D/7343-31	T520D227M010A(3)E025	220	10	25	3,000	2,000	3	105	3
10	220	D/7343-31	T525D227M010A(3)E025	220	10	25	3,000	2,000	3	125	5
10	220	D/7343-31	T520D227M010A(3)E040	220	10	40	2,400	2,000	3	105	3
10	220	Y/7343-40	T530Y227M010A(3)E006	220	8	6	6,600	2,000	3	125	5
10	220	Y/7343-40	T520Y227M010A(3)E040	220	10	40	2,500	2,000	3	105	3
10	330	Y/7343-40	T520Y337M010A(3)E015	330	10	15	4,000	2,000	3	105	3
10	330	Y/7343-40	T520Y337M010A(3)E025	330	10	25	3,100	2,000	3	105	3
10	330	Y/7343-40	T520Y337M010A(3)E035	330	10	35	2,600	2,000	3	105	3
10	330	Y/7343-40	T525Y337M010A(3)E025	330	10	25	3,100	2,000	3	125	5
10	330	Y/7343-40	T525Y337M010A(3)E035	330	10	35	2,600	2,000	3	125	5
10	330	X/7343-43	T530X337M010A(3)E004	330	8	4	8,200	2,000	3	125	5
10	330	X/7343-43	T530X337M010A(3)E005	330	8	5	7,300	2,000	3	125	5
10	330	X/7343-43	T530X337M010A(3)E006	330	8	6	6,700	2,000	3	125	5
10	330	X/7343-43	T520X337M010A(3)E010	330	10	10	5,000	2,000	3	105	3
10	330	X/7343-43	T530X337M010A(3)E010	330	8	10	5,200	2,000	3	125	5
10	330	X/7343-43	T520X337M010A(3)E025	330	10	25	3,100	2,000	3	105	3
10	330	X/7343-43	T520X337M010A(3)E035	330	10	35	2,700	2,000	3	105	3
10	330	J/7360-15	T523J337M010APE070	330	10	70	2,510	2,000	3	85	1
10	470	X/7343-43	T530X477M010A(3)E020	470	10	20	3,670	2,000	3	125	5
10	470	J/7360-15	T523J477M010APE070	470	10	70	2,510	2,000	3	85	1
10	820	H/7360-20	T520H827M010A(3)E070	820	20	70	1,200	2,000	3	85	1
10	330	X/7343-43	T520X337M010A(3)E040	330	10	40	2,500	2,000	3	105	3
11	47	Q/7343-12	T520Q476M011A(3)E040	52	10	40	4,500	2,000	3	105	4
12.5	10	T/3528-12	T520T106M12RA(3)E080	12.5	8	80	1,100	2,000	3	105	4
12.5	10	T/3528-12	T520T106M12RA(3)E150	12.5	8	150	800	2,000	3	105	4
12.5	15	T/3528-12	T520T156M12RA(3)E080	18.75	8	80	1,100	2,000	3	105	4
12.5	47	T/3528-12	T521T476M12RA(3)E090	58.8	8	90	1,330	2,000	3	105	4
16	10	P/2012-10	T529P106M016AAE150 ^	80	6 *	150	408	1,000	3	105	4
16	10	A/3216-18	T521A106M016ATE200 ^	16	8 *	200	612	2,000	3	105	4
16	10	B/3528-21	T520B106M016A(3)E100**	16	8	100	1,100	2,000	3	105	4
16	10	B/3528-21	T521B106M016A(3)E100	16	8	100	1,410	2,000	3	125	5
16	15	B/3528-21	T521B156M016A(3)E090	24	8	90	1,490	2,000	3	105	4
VDC at 105°C	µF	KEMET/EIA	(See below for part options)	µA at 25°C Maximum/ 5 Minutes	% at 25°C 120 Hz Maximum	mΩ at 25°C 100 kHz Maximum	mA at +45°C 100 kHz	(Hours)	Reflow Temp ≤ 260°C	°C	
Rated Voltage	Rated Capacitance	Case Code/Case Size	KEMET Part Number	DC Leakage	DF	ESR	Maximum Allowable Ripple Current	Endurance	MSL	Maximum Operating Temp	Derating Category

(2) To complete KEMET part number, insert M for ±20% or K for ±10%. Designates Capacitance tolerance.

(3) To complete KEMET part number, insert T = 100% Matte Tin (Sn)-plated or H = Standard Solder coated (SnPb 5% Pb minimum). Refer to Ordering Information for additional detail.

Higher voltage ratings and tighter ESR may be substituted within the same size at KEMET's option. Voltage substitutions will be marked with the higher voltage rating. Substitutions can include better than series.

Part numbers marked in blue font are not recommended for new designs. Please use the T521 series instead.

^ Denotes the large reel (13") is not available.

\* DF measurement condition is 120 Hz/0.5 V<sub>rms</sub>/1.5 V DC Bias  
Refer to Ordering Information for additional detail.

**Table 1 – Ratings & Part Number Reference cont.**

Rated Voltage VDC at 105°C	Rated Capacitance	Case Code/Case Size	KEMET Part Number	DC Leakage	DF	ESR	Maximum Allowable Ripple Current	Endurance	MSL	Maximum Operating Temperature	Derating Category
Not all parts are 105°C rated	µF	KEMET/EIA	(See below for part options)	µA at 25°C Maximum/ 5 Minutes	% at 25°C 120 Hz Maximum	mΩ at 25°C 100 kHz Maximum	(rms) mA at +45°C 100 kHz	(Hours)	Reflow Temp ≤ 260°C	°C	
16	22	3216-08	TF08A226M016APE200 ^	70.4	10 *	200	548	1,000	4	105	4
16	22	B/3528-21	T521B226M016A(3)E090	35.2	8	90	1,490	2,000	3	105	4
16	22	C/6032-28	T520C226M016A(3)E080	35.2	8	80	1,400	2,000	3	105	4
16	33	S/3216-12	T527S336M016ATE200 ^	54	10 *	200	548	1,000	4	105	4
16	33	T/3528-12	T521T336M016A(3)E045	52.8	8	45	1,890	2,000	3	105	4
16	33	T/3528-12	T521T336M016A(3)E050	52.8	10	50	1,790	2,000	3	105	4
16	33	B/3528-21	T521B336M016A(3)E070	52.8	8	70	1,690	2,000	3	105	4
16	33	B/3528-21	T521B336M016A(3)E090	52.8	8	90	1,490	2,000	3	105	4
16	33	B/3528-21	T525B336M016A(3)E070	52.8	8	70	1,300	2,000	3	125	6
16	33	B/3528-21	T525B336M016A(3)E090	52.8	8	90	1,200	2,000	3	125	6
16	33	Q/7343-12	T521Q336M016A(3)E040	52.8	10	40	2,500	2,000	3	105	4
16	33	W/7343-15	T520W336M016A(3)E045	52.8	10	45	2,000	2,000	3	105	4
16	33	V/7343-19	T520V336M016A(3)E045	52.8	10	45	2,000	2,000	3	105	4
16	33	V/7343-19	T520V336M016A(3)E060	52.8	10	60	1,800	2,000	3	105	4
16	33	V/7343-19	T520V336M016A(3)E070	52.8	10	70	1,600	2,000	3	105	4
16	47	T/3528-12	T523T476M016APE090	75.2	10	90	1,080	2,000	4	85	2
16	47	B/3528-21	T521B476M016A(3)E055	75.2	10	55	1,900	2,000	3	125	5
16	47	B/3528-21	T521B476M016A(3)E090	75.2	10	90	1,490	2,000	3	125	5
16	47	W/7343-15	T521W476M016A(3)E040	75.2	10	40	2,530	2,000	3	105	4
16	47	W/7343-15	T520W476M016A(3)E045**	75.2	10	45	2,000	2,000	3	105	4
16	47	W/7343-15	T521W476M016A(3)E045	75.2	10	45	2,380	2,000	3	105	4
16	47	V/7343-19	T521V476M016A(3)E040	75.2	10	40	2,560	2,000	3	125	8
16	47	V/7343-19	T520V476M016A(3)E045	75.2	10	45	2,000	2,000	3	105	4
16	47	V/7343-19	T521V476M016A(3)E055	75.2	10	55	2,220	2,000	3	125	8
16	47	V/7343-19	T520V476M016A(3)E070**	75.2	10	70	1,600	2,000	3	105	4
16	47	V/7343-19	T521V476M016A(3)E070	75.2	10	70	1,960	2,000	3	125	8
16	47	V/7343-19	T521V476M016A(3)E080	75.2	10	80	1,840	2,000	3	125	8
16	47	D/7343-31	T520D476M016A(3)E035	75.2	10	35	2,500	2,000	3	105	4
16	47	D/7343-31	T525D476M016A(3)E035	75.2	10	35	2,500	2,000	3	125	8
16	47	D/7343-31	T521D476M016A(3)E040	75.2	10	40	2,810	2,000	3	125	8
16	47	D/7343-31	T521D476M016A(3)E045	75.2	10	45	2,650	2,000	3	125	8
16	47	D/7343-31	T521D476M016A(3)E055	75.2	10	55	2,390	2,000	3	125	5
16	47	D/7343-31	T525D476M016A(3)E065	75.2	10	65	1,900	2,000	3	125	7
16	47	D/7343-31	T520D476M016A(3)E070**	75.2	10	70	1,800	2,000	3	105	4
16	47	D/7343-31	T521D476M016A(3)E070	75.2	10	70	2,120	2,000	3	125	8
16	47	D/7343-31	T521D476M016A(3)E090	75.2	10	90	1,870	2,000	3	125	8
16	68	W/7343-15	T523W686M016APE050	108.8	10	50	2,820	2,000	3	105	4
16	68	W/7343-15	T523W686M016APE070	108.8	10	70	2,376	2,000	3	105	4
16	68	W/7343-15	T523W686M016APE100	108.8	10	100	1,988	2,000	3	105	4
16	68	V/7343-19	T521V686M016A(3)E040	108.8	10	40	2,600	2,000	3	125	8
16	68	V/7343-19	T521V686M016A(3)E050	108.8	10	50	2,320	2,000	3	125	8
VDC at 105°C	µF	KEMET/EIA	(See below for part options)	µA at 25°C Maximum/ 5 Minutes	% at 25°C 120 Hz Maximum	mΩ at 25°C 100 kHz Maximum	mA at +45°C 100 kHz	(Hours)	Reflow Temp ≤ 260°C	°C	
Rated Voltage	Rated Capacitance	Case Code/Case Size	KEMET Part Number	DC Leakage	DF	ESR	Maximum Allowable Ripple Current	Endurance	MSL	Maximum Operating Temp	Derating Category

(2) To complete KEMET part number, insert M for ±20% or K for ±10%. Designates Capacitance tolerance.

(3) To complete KEMET part number, insert T = 100% Matte Tin (Sn)-plated or H = Standard Solder coated (SnPb 5% Pb minimum). Refer to Ordering Information for additional detail.

Higher voltage ratings and tighter ESR may be substituted within the same size at KEMET's option. Voltage substitutions will be marked with the higher voltage rating. Substitutions can include better than series.

Part numbers marked in blue font are not recommended for new designs. Please use the T521 series instead.

^ Denotes the large reel (13") is not available.

\* DF measurement condition is 120 Hz/0.5 V<sub>rms</sub>/1.5 V DC Bias  
Refer to Ordering Information for additional detail.

**Table 1 – Ratings & Part Number Reference cont.**

Rated Voltage VDC at 105°C	Rated Capacitance	Case Code/ Case Size	KEMET Part Number	DC Leakage	DF	ESR	Maximum Allowable Ripple Current	Endurance	MSL	Maximum Operating Temperature	Derating Category
Not all parts are 105°C rated	µF	KEMET/EIA	(See below for part options)	µA at 25°C Maximum/ 5 Minutes	% at 25°C 120 Hz Maximum	mΩ at 25°C 100 kHz Maximum	(rms) mA at +45°C 100 kHz	(Hours)	Reflow Temp ≤ 260°C	°C	
16	68	V/7343-19	T521V686M016A(3)E090	108.8	10	90	1,730	2,000	3	125	8
16	68	D/7343-31	T520D686M016A(3)E050	108.8	10	50	2,100	2,000	3	105	4
16	100	W/7343-15	T523W107M016APE050	160	10	50	2,820	2,000	3	105	4
16	100	W/7343-15	T523W107M016APE070	160	10	70	2,376	2,000	3	105	4
16	100	W/7343-15	T523W107M016APE100	160	10	100	1,988	2,000	3	105	4
16	100	V/7343-19	T521V107M016A(3)E040	160	10	40	2,600	2,000	3	125	8
16	100	V/7343-19	T521V107M016A(3)E050	160	10	50	2,320	2,000	3	125	8
16	100	V/7343-20	T521V107M016ATK050	80	10	50	2,320	2,000	3	125	5
16	100	V/7343-20	T521V107M016ATI050	48	10	50	2,320	2,000	3	125	5
16	100	D/7343-31	T521D107M016A(3)E050	160	10	50	2,510	2,000	3	105	4
16	150	W/7343-15	T523W157M016APE050	240	10	50	2,820	2,000	3	105	4
16	150	W/7343-15	T523W157M016APE070	240	10	70	2,376	2,000	3	105	4
16	150	W/7343-15	T523W157M016APE100	240	10	100	1,988	2,000	3	105	4
16	150	V/7343-20	T521V157M016ATE040	240	10	40	2,600	2,000	3	105	4
16	150	V/7343-20	T521V157M016ATE050	240	10	50	2,320	2,000	3	105	4
16	150	V/7343-20	T521V157M016ATK050	120	10	50	2,320	2,000	3	105	4
16	150	V/7343-20	T521V157M016ATE070	240	10	70	1,960	2,000	3	105	4
16	150	V/7343-20	T521V157M016ATK070	120	10	70	1,960	2,000	3	105	4
16	150	V/7343-20	T521V157M016ATE100	240	10	100	1,640	2,000	3	105	4
16	150	V/7343-20	T521V157M016ATK100	120	10	100	1,640	2,000	3	105	4
16	150	D/7343-31	T521D157M016A(3)E050	240	10	50	2,510	2,000	3	105	4
16	150	D/7343-31	T521D157M016A(3)E040	240	10	40	2,810	2,000	3	105	4
16	150	X/7343-43	T530X157M016A(3)E015	240	8	15	4,200	2,000	3	125	6
16	150	X/7343-43	T530X157M016A(3)E025	240	8	25	3,300	2,000	3	125	6
16	150	X/7343-43	T520X157M016A(3)E040	240	10	40	2,500	2,000	3	105	4
16	150	X/7343-43	T530X157M016A(3)E040	240	8	40	2,600	2,000	3	125	6
16	150	X/7343-43	T521X157M016A(3)E080	240	10	80	2,240	2,000	3	105	4
16	220	D/7343-31	T521D227M016A(3)E025	352	10	25	3,550	2,000	3	125	8
16	220	D/7343-31	T521D227M016A(3)E035	352	10	35	3,000	2,000	3	125	8
16	220	D/7343-31	T521D227M016A(3)E050	352	10	50	2,510	2,000	3	125	8
16	220	X/7343-43	T521X227M016A(3)E035	352	10	35	3,380	2,000	3	125	5
16	220	X/7343-43	T521X227M016A(3)E050	352	10	50	2,830	2,000	3	125	5
16	220	H/7360-20	T523H227M016APE070	352	10	70	2,510	2,000	3	85	2
16	220	J/7360-15	T523J227M016APE070	352	10	70	2,510	2,000	3	85	2
16	330	X/7343-43	T521X337M016A(3)E015	528	10	15	5,160	2,000	3	125	5
16	330	X/7343-43	T521X337M016A(3)E025	528	10	25	4,000	2,000	3	125	5
16	330	X/7343-43	T521X337M016A(3)K025	264	10	25	4,000	2,000	3	125	5
16	330	X/7343-43	T521X337M016A(3)E050	528	10	50	2,830	2,000	3	125	5
16	330	X/7343-43	T521X337M016A(3)K050	264	10	50	2,830	2,000	3	125	5
16	330	H/7360-20	T523H337M016APE070	528	10	70	2,510	2,000	3	85	2
16	470	X/7343-43	T521X477M016A(3)E020	752	10	20	4,470	2,000	3	125	5
VDC at 105°C	µF	KEMET/EIA	(See below for part options)	µA at 25°C Maximum/ 5 Minutes	% at 25°C 120 Hz Maximum	mΩ at 25°C 100 kHz Maximum	mA at +45°C 100 kHz	(Hours)	Reflow Temp ≤ 260°C	°C	
Rated Voltage	Rated Capacitance	Case Code/ Case Size	KEMET Part Number	DC Leakage	DF	ESR	Maximum Allowable Ripple Current	Endurance	MSL	Maximum Operating Temp	Derating Category

(2) To complete KEMET part number, insert M for ±20% or K for ±10%. Designates Capacitance tolerance.

(3) To complete KEMET part number, insert T = 100% Matte Tin (Sn)-plated or H = Standard Solder coated (SnPb 5% Pb minimum). Refer to Ordering Information for additional detail.

Higher voltage ratings and tighter ESR may be substituted within the same size at KEMET's option. Voltage substitutions will be marked with the higher voltage rating. Substitutions can include better than series.

**Part numbers marked in blue font are not recommended for new designs. Please use the T521 series instead.**

^ Denotes the large reel (13") is not available.

\* DF measurement condition is 120 Hz/0.5 V<sub>rms</sub>/1.5 V DC Bias  
Refer to Ordering Information for additional detail.

**Table 1 – Ratings & Part Number Reference cont.**

Rated Voltage VDC at 105°C	Rated Capacitance	Case Code/ Case Size	KEMET Part Number	DC Leakage	DF	ESR	Maximum Allowable Ripple Current	Endurance	MSL	Maximum Operating Temperature	Derating Category
Not all parts are 105°C rated	µF	KEMET/EIA	(See below for part options)	µA at 25°C Maximum/ 5 Minutes	% at 25°C 120 Hz Maximum	mΩ at 25°C 100 kHz Maximum	(rms) mA at +45°C 100 kHz	(Hours)	Reflow Temp ≤ 260°C	°C	
16	470	X/7343-43	T521X477M016A(3)K020	376	10	20	4,470	2,000	3	125	5
16	470	X/7343-43	T521X477M016A(3)I020	226	10	20	4,470	2,000	3	125	5
20	10	B/3528-21	T521B106M020A(3)E100	20	8	100	1,410	2,000	3	125	5
20	15	B/3528-21	T521B156M020A(3)E090	30	10	90	1,490	2,000	3	105	4
20	22	B/3528-21	T521B226M020A(3)E090	44	8	90	1,490	2,000	3	105	4
20	22	W/7343-15	T521W226(2)020A(3)E040	44	10	40	2,530	2,000	3	105	4
20	22	W/7343-15	T521W226(2)020A(3)E055	44	10	55	2,150	2,000	3	105	4
20	22	W/7343-15	T521W226(2)020A(3)E070	44	10	70	1,910	2,000	3	105	4
20	22	V/7343-19	T520V226M020A(3)E040	44	10	40	2,200	2,000	3	105	4
20	22	V/7343-19	T520V226M020A(3)E045	44	10	45	2,000	2,000	3	105	4
20	22	V/7343-19	T520V226M020A(3)E090**	44	10	90	1,400	2,000	3	105	4
20	22	V/7343-19	T521V226M020A(3)E090	44	10	90	1,730	2,000	3	125	8
20	33	B/3528-21	T521B336M020ATE090 ^	132	10 *	90	972	2,000	3	105	4
20	47	W/7343-15	T521W476M020A(3)E040	94	9	40	2,530	2,000	3	105	4
20	47	W/7343-15	T521W476K020A(3)E045	94	9	45	2,380	2,000	3	105	4
20	47	V/7343-19	T521V476M020A(3)E090	94	10	90	1,730	2,000	3	125	5
20	47	V/7343-19	T521V476M020A(3)E080	94	10	80	1,840	2,000	3	125	5
20	47	V/7343-19	T521V476M020A(3)E055	94	10	55	2,220	2,000	3	125	5
20	47	D/7343-31	T521D476M020A(3)E055	94	10	55	2,390	2,000	3	125	5
20	47	D/7343-31	T521D476M020A(3)E040	94	10	40	2,810	2,000	3	125	5
20	68	V/7343-19	T521V686M020A(3)E050	136	10	50	2,320	2,000	3	105	4
20	68	V/7343-20	T523V686M020APE100	136	10	100	1,400	2,000	3	105	4
20	100	W/7343-15	T523W107M020APE050	200	10	50	2,820	2,000	3	105	4
20	100	W/7343-15	T523W107M020APE070	200	10	70	2,376	2,000	3	105	4
20	100	W/7343-15	T523W107M020APE100	200	10	100	1,988	2,000	3	105	4
20	100	V/7343-19	T521V107M020A(3)E055	200	10	55	2,220	2,000	3	125	5
20	100	D/7343-31	T521D107(2)020A(3)E055	200	10	55	2,390	2,000	3	125	7
20	150	V/7343-20	T523V157M020APE050	300	10	50	2,870	2,000	3	105	4
20	150	V/7343-20	T523V157M020APE070	300	10	70	2,420	2,000	3	105	4
20	150	V/7343-20	T523V157M020APE100	300	10	100	2,030	2,000	3	105	4
20	150	D/7343-31	T521D157M020A(3)E065	300	10	65	2,200	2,000	3	105	4
20	150	D/7343-31	T521D157M020A(3)E050	300	10	50	2,510	2,000	3	105	4
25	4.7	P/2012-10	T529P475M025AAE300 ^	35.3	10 *	300	289	1,000	3	105	4
25	6.8	T/3528-12	T521T685M025ATE100 ^	34	8 *	100	866	2,000	3	105	4
25	10	S/3216-12	T527S106M025ATE150 ^	50	10 *	150	632	1,000	3	105	4
25	10	A/3216-18	T521A106M025ATE150 ^	25	6 *	150	707	2,000	3	105	4a
25	10	M/3528-15	T521M106M025ATE100 ^	50	10 *	100	922	2,000	3	105	4
25	10	B/3528-21	T521B106M025A(3)E100	25	8	100	1,410	2,000	3	125	5
25	10	T/3528-12	T521T106M025A(3)E100	25	8	100	1,270	2,000	3	125	5
25	10	T/3528-12	T521T106M025A(3)E060	25	8	60	1,630	2,000	3	125	5
25	15	B/3528-21	T521B156M025ATE090 ^	112.5	10 *	90	972	2,000	3	125	6
VDC at 105°C	µF	KEMET/EIA	(See below for part options)	µA at 25°C Maximum/ 5 Minutes	% at 25°C 120 Hz Maximum	mΩ at 25°C 100 kHz Maximum	mA at +45°C 100 kHz	(Hours)	Reflow Temp ≤ 260°C	°C	
Rated Voltage	Rated Capacitance	Case Code/ Case Size	KEMET Part Number	DC Leakage	DF	ESR	Maximum Allowable Ripple Current	Endurance	MSL	Maximum Operating Temp	Derating Category

(2) To complete KEMET part number, insert M for ±20% or K for ±10%. Designates Capacitance tolerance.

(3) To complete KEMET part number, insert T = 100% Matte Tin (Sn)-plated or H = Standard Solder coated (SnPb 5% Pb minimum). Refer to Ordering Information for additional detail.

Higher voltage ratings and tighter ESR may be substituted within the same size at KEMET's option. Voltage substitutions will be marked with the higher voltage rating. Substitutions can include better than series.

Part numbers marked in blue font are not recommended for new designs. Please use the T521 series instead.

^ Denotes the large reel (13") is not available.

\* DF measurement condition is 120 Hz/0.5 V<sub>rms</sub>/1.5 V DC Bias  
Refer to Ordering Information for additional detail.

**Table 1 – Ratings & Part Number Reference cont.**

Rated Voltage VDC at 105°C	Rated Capacitance	Case Code/Case Size	KEMET Part Number	DC Leakage	DF	ESR	Maximum Allowable Ripple Current	Endurance	MSL	Maximum Operating Temperature	Derating Category
Not all parts are 105°C rated	µF	KEMET/EIA	(See below for part options)	µA at 25°C Maximum/ 5 Minutes	% at 25°C 120 Hz Maximum	mΩ at 25°C 100 kHz Maximum	(rms) mA at +45°C 100 kHz	(Hours)	Reflow Temp ≤ 260°C	°C	
25	15	B/3528-21	T521B156M025A(3)E100	37.5	8	100	1,410	2,000	3	105	4
25	15	T/3528-12	T527T156M025ATE100 ^	112.5	10 *	100	866	2,000	3	105	4
25	15	K/3528-10	T527K156M025ATE150 ^	75.0	10 *	150	633	1,000	3	105	4
25	15	V/7343-19	T520V156M025A(1)E090**	37.5	10	90	1,400	2,000	3	105	4
25	15	V/7343-19	T521V156M025A(3)E090	37.5	10	90	1,730	2,000	3	105	4
25	15	V/7343-19	T521V156M025A(3)E040	37.5	10	40	2,560	2,000	3	105	4
25	15	D/7343-31	T520D156M025A(3)E060	37.5	10	60	1,900	2,000	3	105	4
25	15	D/7343-31	T520D156M025A(3)E080	37.5	10	80	1,700	2,000	3	105	4
25	22	T/3528-12	T527T226M025ATE100 ^	165	10 *	100	886	2,000	3	105	4
25	22	B/3528-21	T521B226M025A(3)E100	55	8	100	1,410	2,000	3	125	8
25	22	W/7343-15	T521W226M025A(3)E040	55	10	40	2,530	2,000	3	105	4
25	22	W/7343-15	T521W226M025A(3)E070	55	10	70	1,910	2,000	3	105	4
25	22	V/7343-19	T521V226M025A(3)E040	55	10	40	2,560	2,000	3	125	7
25	22	V/7343-19	T521V226M025A(3)E045	55	10	45	2,450	2,000	3	125	7
25	22	V/7343-19	T521V226M025A(3)E060	55	10	60	2,120	2,000	3	125	7
25	22	V/7343-19	T521V226M025A(3)E090	55	10	90	1,730	2,000	3	125	7
25	33	W/7343-15	T523W336M025APE100	82.5	10	100	1,988	2,000	4	105	4
25	33	V/7343-19	T521V336M025A(3)E025	82.5	10	25	3,290	2,000	3	125	7
25	33	V/7343-19	T521V336M025A(3)E060	82.5	10	60	2,120	2,000	3	125	7
25	33	V/7343-19	T521V336M025A(3)E040	82.5	10	40	2,560	2,000	3	125	7
25	33	D/7343-31	T521D336M025A(3)E040	82.5	10	40	2,810	2,000	3	125	8
25	33	D/7343-31	T521D336M025A(3)E060	82.5	10	60	2,290	2,000	3	125	8
25	47	V/7343-20	T523V476M025APE100	117.5	10	100	1,400	2,000	3	105	4
25	47	D/7343-31	T521D476M025A(3)E065	117.5	10	65	2,200	2,000	3	125	8
25	47	W/7343-15	T523W476M025APE050	117.5	10	50	2,820	2,000	3	105	4
25	47	W/7343-15	T523W476M025APE070	117.5	10	70	2,376	2,000	3	105	4
25	47	W/7343-15	T523W476M025APE100	117.5	10	100	1,988	2,000	3	105	4
25	68	W/7343-15	T523W686M025APE050	170	10	50	2,820	2,000	3	105	4
25	68	W/7343-15	T523W686M025APE070	170	10	70	2,376	2,000	3	105	4
25	68	W/7343-15	T523W686M025APE100	170	10	100	1,988	2,000	3	105	4
25	68	D/7343-31	T521D686M025A(3)E070	170	10	70	2,120	2,000	3	125	8
25	100	D/7343-31	T521D107M025A(3)E040	250	10	40	2,810	2,000	3	125	8
25	100	D/7343-31	T521D107M025A(3)E050	250	10	50	2,510	2,000	3	125	8
25	100	D/7343-31	T521D107M025A(3)E060	250	10	60	2,290	2,000	3	125	8
25	100	X/7343-43	T521X107M025A(3)E030	250	10	30	3,650	2,000	3	125	7
25	100	X/7343-43	T521X107M025A(3)E060	250	10	60	2,580	2,000	3	125	7
25	150	D/7343-31	T521D157M025ATE040	375	10	40	2,810	2,000	3	125	7
25	150	D/7343-31	T521D157M025ATE050	375	10	50	2,510	2,000	3	125	7
35	3.3	B/3528-21	T521B335M035A(3)E150	11.6	8	150	1,160	2,000	3	105	4
35	3.3	B/3528-21	T521B335M035A(3)E200	11.6	8	200	1,000	2,000	3	105	4
35	4.7	B/3528-21	T521B475M035A(3)E150	16.5	8	150	1,160	2,000	3	105	4
VDC at 105°C	µF	KEMET/EIA	(See below for part options)	µA at 25°C Maximum/ 5 Minutes	% at 25°C 120 Hz Maximum	mΩ at 25°C 100 kHz Maximum	mA at +45°C 100 kHz	(Hours)	Reflow Temp ≤ 260°C	°C	
Rated Voltage	Rated Capacitance	Case Code/Case Size	KEMET Part Number	DC Leakage	DF	ESR	Maximum Allowable Ripple Current	Endurance	MSL	Maximum Operating Temp	Derating Category

(2) To complete KEMET part number, insert M for ±20% or K for ±10%. Designates Capacitance tolerance.

(3) To complete KEMET part number, insert T = 100% Matte Tin (Sn)-plated or H = Standard Solder coated (SnPb 5% Pb minimum). Refer to Ordering Information for additional detail.

Higher voltage ratings and tighter ESR may be substituted within the same size at KEMET's option. Voltage substitutions will be marked with the higher voltage rating. Substitutions can include better than series.

Part numbers marked in blue font are not recommended for new designs. Please use the T521 series instead.

^ Denotes the large reel (13") is not available.

\* DF measurement condition is 120 Hz/0.5 V<sub>rms</sub>/1.5 V DC Bias  
Refer to Ordering Information for additional detail.

**Table 1 – Ratings & Part Number Reference cont.**

Rated Voltage VDC at 105°C	Rated Capacitance	Case Code/Case Size	KEMET Part Number	DC Leakage	DF	ESR	Maximum Allowable Ripple Current	Endurance	MSL	Maximum Operating Temperature	Derating Category
Not all parts are 105°C rated	µF	KEMET/EIA	(See below for part options)	µA at 25°C Maximum/ 5 Minutes	% at 25°C 120 Hz Maximum	mΩ at 25°C 100 kHz Maximum	(rms) mA at +45°C 100 kHz	(Hours)	Reflow Temp ≤ 260°C	°C	
35	4.7	B/3528-21	T521B475M035A(3)E200	16.5	8	200	1,000	2,000	3	105	4
35	6.8	T/3528-12	T521T685M035APE090	23.8	10	90	1,330	2,000	3	125	5
35	6.8	B/3528-21	T521B685M035A(3)E150	23.8	8	150	1,160	2,000	3	105	4
35	6.8	B/3528-21	T521B685M035A(3)E200	23.8	8	200	1,000	2,000	3	105	4
35	10	B/3528-21	T521B106M035A(3)E150	35	8	150	1,160	2,000	3	105	4
35	10	B/3528-21	T521B106M035A(3)E200	35	8	200	1,000	2,000	3	105	4
35	10	V/7343-19	T521V106M035A(3)E120	35	10	120	1,500	2,000	3	125	5
35	15	V/7343-19	T521V156M035A(3)E100	52.5	10	100	1,640	2,000	3	125	5
35	15	V/7343-19	T521V156M035A(3)E125	52.5	10	125	1,470	2,000	3	125	5
35	22	W/7343-15	T523W226M035APE100	77	10	100	1,988	2,000	3	105	4
35	22	D/7343-31	T521D226M035A(3)E040	77	10	40	2,810	2,000	3	125	5
35	22	D/7343-31	T521D226M035A(3)E060	77	10	60	2,290	2,000	3	125	5
35	33	V/7343-20	T523V336M035APE100	115.5	10	100	1,400	2,000	3	105	4
35	33	D/7343-31	T521D336M035A(3)E065	115.5	10	65	2,200	2,000	3	125	5
35	47	V/7343-20	T523V476M035APE100	164.5	10	100	1,400	2,000	3	105	4
35	47	X/7343-43	T521X476M035A(3)E030	164.5	10	30	3,650	2,000	3	125	5
35	47	X/7343-43	T521X476M035A(3)E070	164.5	10	70	2,390	2,000	3	125	5
35	47	W/7343-15	T523W476M035APE090	164.5	10	90	2,100	2,000	3	105	4
35	47	W/7343-15	T523W476M035APE100	164.5	10	100	1,988	2,000	3	105	4
35	56	W/7343-15	T523W566M035APE070	196	10	70	2,376	2,000	3	105	4
35	56	W/7343-15	T523W566M035APE100	196	10	100	1,988	2,000	3	105	4
35	68	X/7343-43	T521X686M035A(3)E050	238	10	50	2,830	2,000	3	125	5
50	0.68	B/3528-21	T521B684M050A(3)E200	3.4	8	200	1,000	2,000	3	105	4
50	1	B/3528-21	T521B105M050A(3)E200	5	8	200	1,000	2,000	3	105	4
50	1.5	B/3528-21	T521B155M050A(3)E200	7.5	8	200	1,000	2,000	3	105	4
50	2.2	B/3528-21	T521B225M050A(3)E200	11	8	200	1,000	2,000	3	105	4
50	3.3	B/3528-21	T521B335M050A(3)E200	16.5	8	200	1,000	2,000	3	105	4
50	5.6	D/7343-31	T521D565M050A(3)E070	28	10	70	2,120	2,000	3	125	5
50	5.6	D/7343-31	T521D565M050A(3)E090	28	10	90	1,870	2,000	3	125	5
50	5.6	V/7343-19	T521V565M050A(3)E070	28	10	70	1,960	2,000	3	125	5
50	5.6	V/7343-19	T521V565M050A(3)E090	28	10	90	1,730	2,000	3	125	5
50	6.8	D/7343-31	T521D685M050A(3)E070	34	10	70	2,120	2,000	3	125	5
50	6.8	D/7343-31	T521D685M050A(3)E090	34	10	90	1,870	2,000	3	125	5
50	6.8	V/7343-19	T521V685M050A(3)E070	34	10	70	1,960	2,000	3	125	5
50	6.8	V/7343-19	T521V685M050A(3)E090	34	10	90	1,730	2,000	3	125	5
50	10	D/7343-31	T521D106M050A(3)E090	50	10	90	1,870	2,000	3	125	5
50	10	D/7343-31	T521D106M050A(3)E120	50	10	120	1,620	2,000	3	125	5
50	10	V/7343-19	T521V106M050A(3)E090	50	10	90	1,730	2,000	3	125	5
50	18	D/7343-31	T521D186M050A(3)E090	90	10	90	1,870	2,000	3	125	5
50	18	X/7343-43	T521X186M050A(3)E070	90	10	70	2,390	2,000	3	125	5
50	18	X/7343-43	T521X186M050A(3)E050	90	10	50	2,830	2,000	3	125	5
VDC at 105°C	µF	KEMET/EIA	(See below for part options)	µA at 25°C Maximum/ 5 Minutes	% at 25°C 120 Hz Maximum	mΩ at 25°C 100 kHz Maximum	mA at +45°C 100 kHz	(Hours)	Reflow Temp ≤ 260°C	°C	
Rated Voltage	Rated Capacitance	Case Code/Case Size	KEMET Part Number	DC Leakage	DF	ESR	Maximum Allowable Ripple Current	Endurance	MSL	Maximum Operating Temp	Derating Category

(2) To complete KEMET part number, insert M for ±20% or K for ±10%. Designates Capacitance tolerance.

(3) To complete KEMET part number, insert T = 100% Matte Tin (Sn)-plated or H = Standard Solder coated (SnPb 5% Pb minimum). Refer to Ordering Information for additional detail.

Higher voltage ratings and tighter ESR may be substituted within the same size at KEMET's option. Voltage substitutions will be marked with the higher voltage rating. Substitutions can include better than series.

**Part numbers marked in blue font are not recommended for new designs. Please use the T521 series instead.**

^ Denotes the large reel (13") is not available.

\* DF measurement condition is 120 Hz/0.5 V<sub>rms</sub>/1.5 V DC Bias  
Refer to Ordering Information for additional detail.

**Table 1 – Ratings & Part Number Reference cont.**

Rated Voltage VDC at 105°C	Rated Capacitance	Case Code/ Case Size	KEMET Part Number	DC Leakage	DF	ESR	Maximum Allowable Ripple Current	Endurance	MSL	Maximum Operating Temperature	Derating Category
Not all parts are 105°C rated	µF	KEMET/EIA	(See below for part options)	µA at 25°C Maximum/ 5 Minutes	% at 25°C 120 Hz Maximum	mΩ at 25°C 100 kHz Maximum	(rms) mA at +45°C 100 kHz	(Hours)	Reflow Temp ≤ 260°C	°C	
50	18	X/7343-43	T521X186M050A(3)E035	90	10	35	3,380	2,000	3	125	5
50	22	D/7343-31	T521D226M050A(3)E090	110	10	90	1,870	2,000	3	125	5
50	22	X/7343-43	T521X226M050A(3)E075	110	10	75	2,310	2,000	3	125	5
50	22	X/7343-43	T521X226M050A(3)E050	110	10	50	2,830	2,000	3	125	5
50	33	X/7343-43	T521X336M050A(3)E075	165	10	75	2,310	2,000	3	125	5
50	33	X/7343-43	T521X336M050A(3)E050	165	10	50	2,830	2,000	3	125	5
63	0.68	B/3528-21	T521B684M063A(3)E200	4.3	8	200	1,000	2,000	3	105	4
63	1	B/3528-21	T521B105M063A(3)E200	6.3	8	200	1,000	2,000	3	105	4
63	1.5	B/3528-21	T521B155M063A(3)E200	9.5	8	200	1,000	2,000	3	105	4
63	4.7	C/6032-28	T521C475M063A(3)E200	29.6	6	200	1,050	2,000	3	105	4
63	4.7	D/7343-31	T521D475M063A(3)E300	29.61	10	300	1,030	2,000	3	125	5
63	4.7	D/7343-31	T521D475M063A(3)E075	29.6	10	75	2,050	2,000	3	125	5
63	6.8	D/7343-31	T521D685M063A(3)E075	42.8	10	75	2,050	2,000	3	125	5
63	10	X/7343-43	T521X106M063A(3)E050	63	10	50	2,830	2,000	3	125	5
63	15	X/7343-43	T521X156M063A(3)E035	94.5	10	35	3,380	2,000	3	125	5
63	15	X/7343-43	T521X156M063A(3)E150	94.5	10	150	1,630	2,000	3	125	5
63	22	X/7343-43	T521X226M063A(3)E075	138.6	10	75	2,310	2,000	3	125	5
75	4.7	D/7343-31	T521D475M075A(3)E075	35.3	10	75	2,050	2,000	3	125	5
75	10	X/7343-43	T521X106M075A(3)E050	75	10	50	2,830	2,000	3	125	5
75	15	X/7343-43	T521X156M075A(3)E035	112.5	10	35	3,380	2,000	3	125	5
VDC at 105°C	µF	KEMET/EIA	(See below for part options)	µA at 25°C Maximum/ 5 Minutes	% at 25°C 120 Hz Maximum	mΩ at 25°C 100 kHz Maximum	mA at +45°C 100 kHz	(Hours)	Reflow Temp ≤ 260°C	°C	
Rated Voltage	Rated Capacitance	Case Code/ Case Size	KEMET Part Number	DC Leakage	DF	ESR	Maximum Allowable Ripple Current	Endurance	MSL	Maximum Operating Temp	Derating Category

(2) To complete KEMET part number, insert M for ±20% or K for ±10%. Designates Capacitance tolerance.

(3) To complete KEMET part number, insert T = 100% Matte Tin (Sn)-plated or H = Standard Solder coated (SnPb 5% Pb minimum). Refer to Ordering Information for additional detail.

Higher voltage ratings and tighter ESR may be substituted within the same size at KEMET's option. Voltage substitutions will be marked with the higher voltage rating. Substitutions can include better than series.

**Part numbers marked in blue font are not recommended for new designs. Please use the T521 series instead.**

^ Denotes the large reel (13") is not available.

\* DF measurement condition is 120 Hz/0.5 V<sub>rms</sub>/1.5 V DC Bias  
Refer to Ordering Information for additional detail.

## Derating Guidelines

### Recommended Application Voltage

KO-CAPs are solid state capacitors that demonstrate no wearout mechanism when operated within their recommended guidelines. While the KO-CAP can be operated at full rated voltage, most circuit designers seek a minimum level of assurance in long term reliability, which should be demonstrated with data. A voltage derating can provide the desired level of demonstrated reliability based on industry accepted acceleration models. Since most applications do require long term reliability, KEMET recommends that designers consider a voltage derating, according to the graphic above, for the maximum steady state voltage.

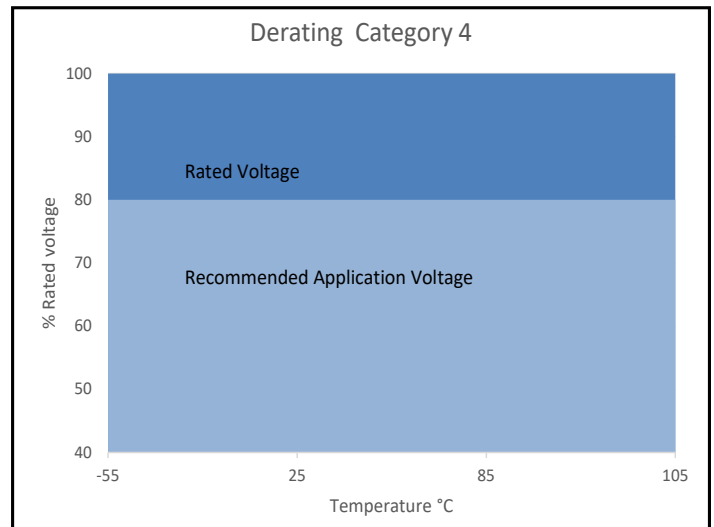
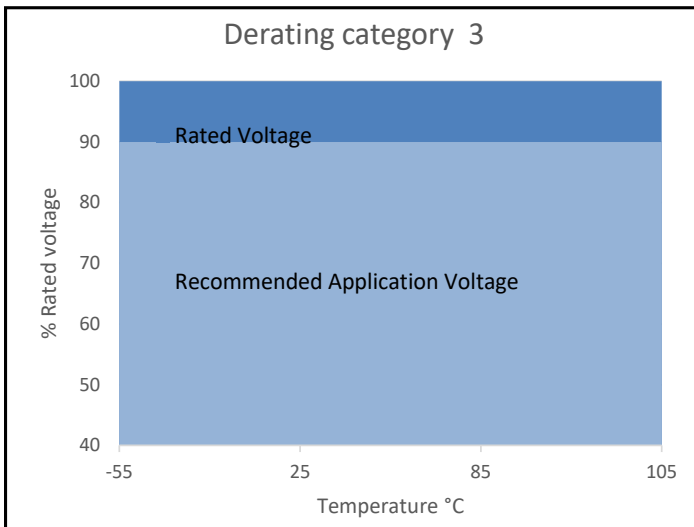
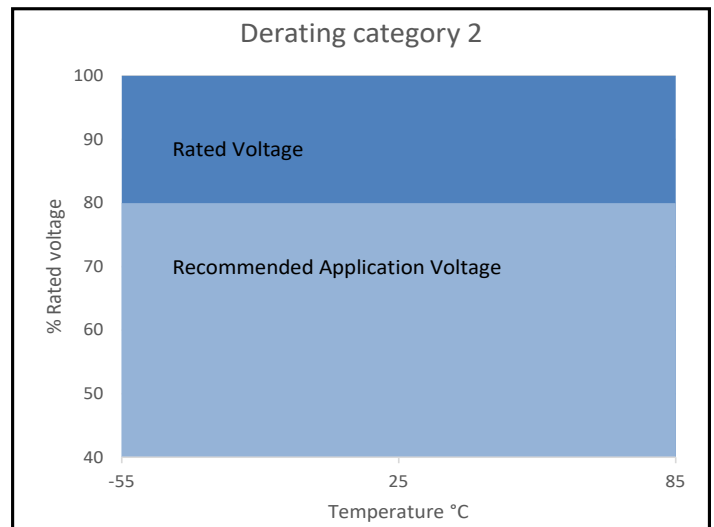
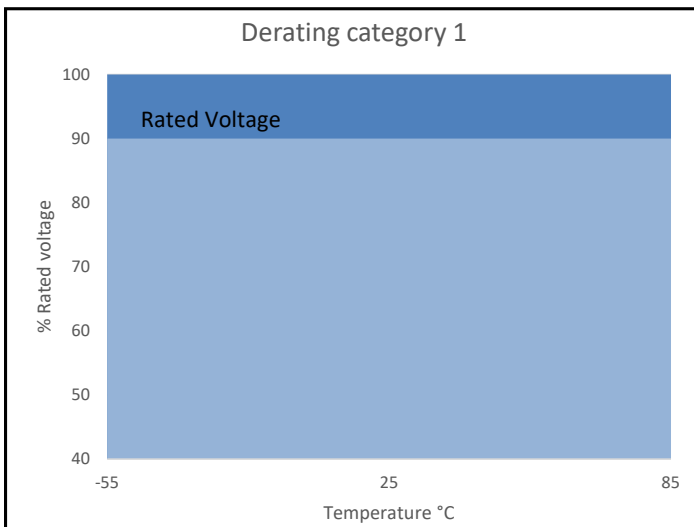

## Derating Guidelines cont.

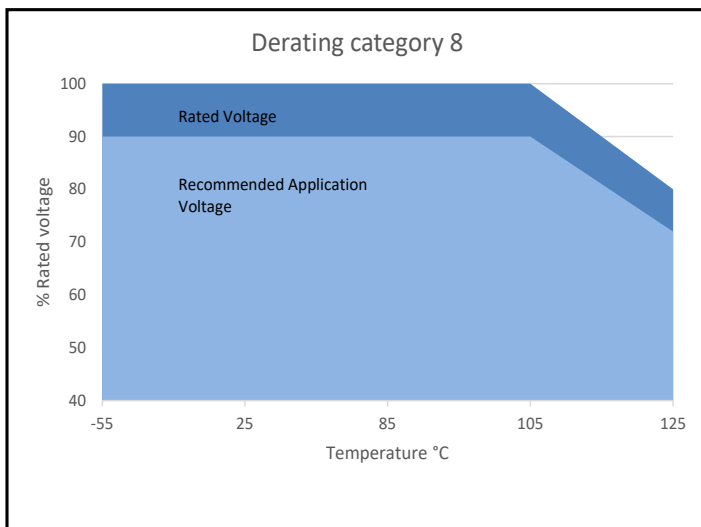
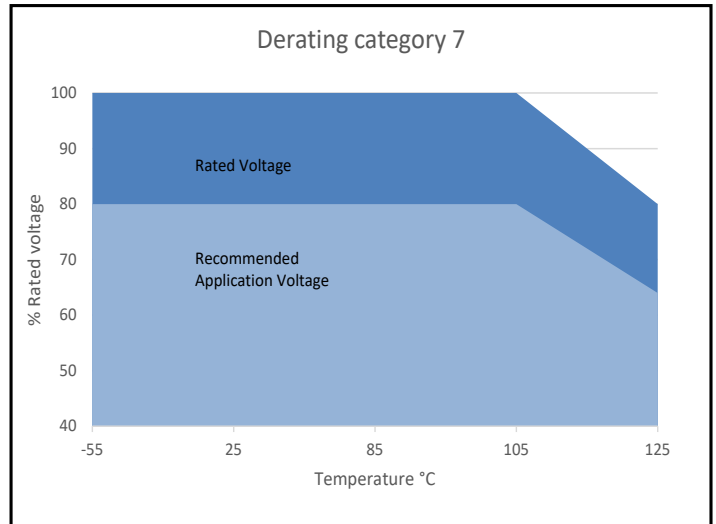
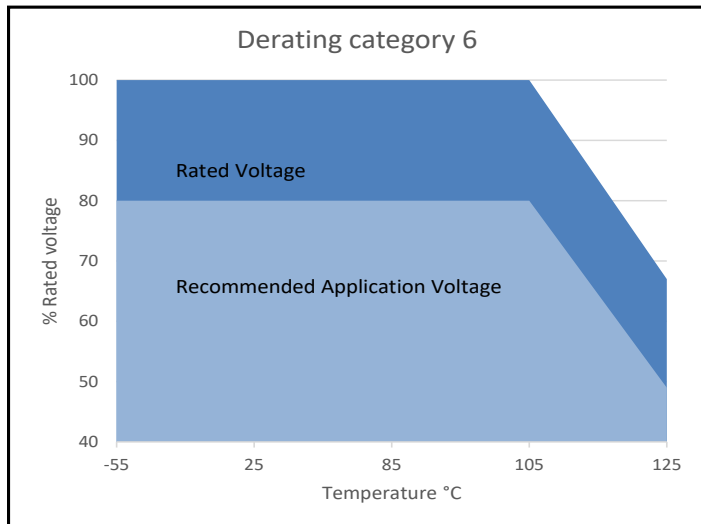
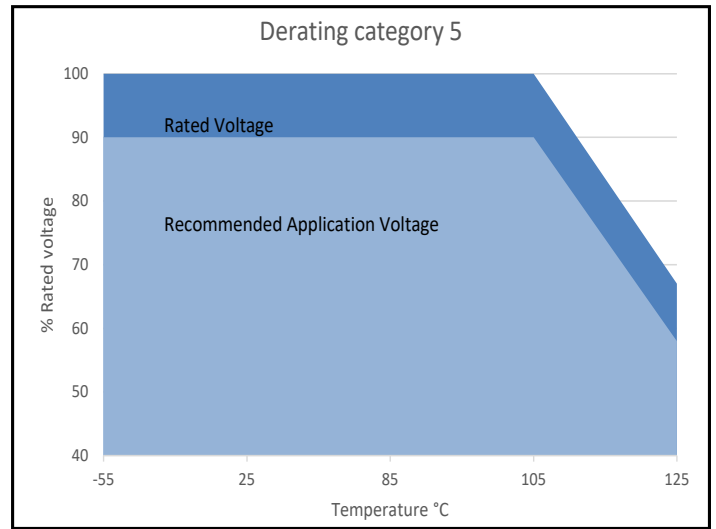
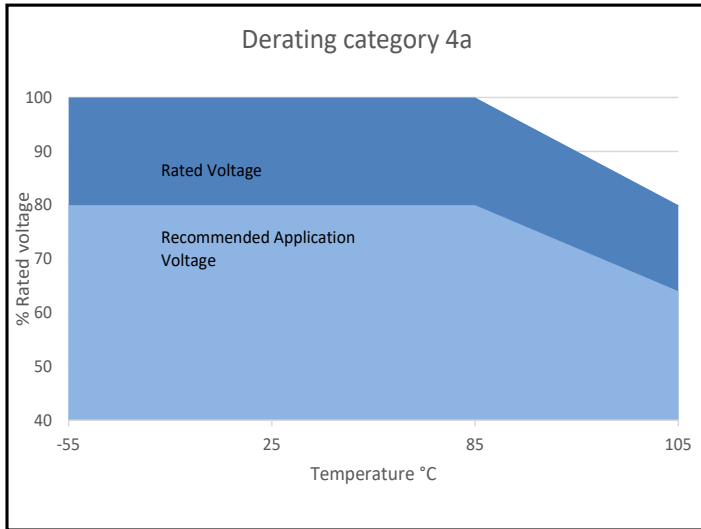

## Ripple Current/Ripple Voltage

Permissible AC ripple voltage and current are related to equivalent series resistance (ESR) and the power dissipation capabilities of the device. Permissible AC ripple voltage, which may be applied is limited by two criteria:

- The positive peak AC voltage plus the DC bias voltage, if any, must not exceed the DC voltage rating of the capacitor.
- The negative peak AC voltage, in combination with bias voltage, if any, must not exceed the allowable limits specified for reverse voltage.

The maximum power dissipation must be reduced with increasing environmental operating temperatures. Refer to the table below for temperature compensation requirements.

Temperature Compensation Multipliers for Maximum Ripple Current				
Max Operational Temperature (Series)	-55°C < T ≤ 45°C	45°C < T ≤ 85°C	85°C < T ≤ 105°C	105°C < T ≤ 125°C
85°C (T520, T523)	1.00	0.7		
105°C (T520, T521, T523, T527, T529, TF)	1.00	0.7	0.25	
125°C (T525, T530)	1.00	0.7	0.25	0.25
125°C dedicated to T521	1.00	1.00	0.70	0.25

T= Environmental Temperature

Maximum Power Dissipation (Pmax) mWatts at 45°C with +30°C Rise						
Case Code	EIA Case Code	T520/T525	T521	T523	T527/T529	T530
P	2012				25	
I / S	3216				60	
A	3216-18	112				
T	3528-12	105	160	105	75	
M	3528-15	120	120			
B	3528-21	127	200			
U	6032-15	135				
L	6032-19	150				
C	6032-28	165	220			
W	7343-15	180	255	395		
V	7343-20	187	270	423		
D	7343-31	225	315			255
Q	7343-12	170	245			
Y	7343-40	241				263
X	7343-43	247	400			270
J	7360-15			440		
H	7360-20	187		440		

## Surge Voltage

Surge voltage is the maximum voltage (peak value) which may be applied to the capacitor. The surge voltage must not be applied for periodic charging and discharging in course of normal operation and cannot be part of the application voltage. Surge voltage capability is demonstrated by application of 1,000 cycles at operating temperature. The parts are charged through a 33 Ohm resistor for 30 seconds and then discharged through a 33 Ohm resistor for each cycle.

Rated Voltage (V)	Surge Voltage (V)	Category Voltage (V)	Category Surge Voltage (V)
-55°C to 105°C		Up to 125°C	
2	2.6	-	
2.5	3.3	1.7	2.2
3	3.9	2.0	2.7
4	5.2	2.7	3.5
6.3	8.2	4.2	5.5
8	10.4	5.4	7.1
10	13	6.7	8.7
12.5	16.25	-	
16	20.8	10.7	13.9
20	26	13.4	17.4
25	32.5	16.8	21.8
35	45.5	23.5	30.5
50	65	33.5	43.6
63	81.9	42.2	54.9
75	97.5	50.3	65.3

## Reverse Voltage

Polymer electrolytic capacitors are polar devices and may be permanently damaged or destroyed if connected in the wrong polarity. These devices will withstand a small degree of transient voltage reversal for short periods as shown in the below table.

Temperature	Permissible Transient Reverse Voltage
25°C	15% of Rated Voltage
55°C	10% of Rated Voltage
85°C	5% of Rated Voltage
105°C	3% of Rated Voltage
125°C*	1% of Rated Voltage

\*For series rated to 125°C

**Table 2 – Land Dimensions/Courtyard**

T520/T521/T525/T530

KEMET	Metric Size Code	Density Level A: Maximum (Most) Land Protrusion (mm)					Density Level B: Median (Nominal) Land Protrusion (mm)					Density Level C: Minimum (Least) Land Protrusion (mm)				
		Case	EIA	W	L	S	V1	V2	W	L	S	V1	V2	W	L	S
A	3216-18	1.35	2.20	0.62	6.02	2.80	1.23	1.80	0.82	4.92	2.30	1.13	1.42	0.98	4.06	2.04
B	3528-21	2.35	2.21	0.92	6.32	4.00	2.23	1.80	1.12	5.22	3.50	2.13	1.42	1.28	4.36	3.24
C	6032-28	2.35	2.77	2.37	8.92	4.50	2.23	2.37	2.57	7.82	4.00	2.13	1.99	2.73	6.96	3.74
D	7343-31	2.55	2.77	3.67	10.22	5.60	2.43	2.37	3.87	9.12	5.10	2.33	1.99	4.03	8.26	4.84
H	7360-20	4.25	2.77	3.67	10.22	7.30	4.13	2.37	3.87	9.12	6.80	4.03	1.99	4.03	8.26	6.54
L	6032-19	2.35	2.77	2.37	8.92	4.50	2.23	2.37	2.57	7.82	4.00	2.13	1.99	2.73	6.96	3.74
M	3528-15	2.35	2.20	0.92	6.32	4.00	2.23	1.80	1.12	5.22	3.50	2.13	1.42	1.28	4.36	3.24
Q	7343-12	2.55	2.77	3.67	10.22	5.60	2.43	2.37	3.87	9.12	5.10	2.33	1.99	4.03	8.26	4.84
T	3528-12	2.35	2.20	0.92	6.32	4.00	2.23	1.80	1.12	5.22	3.50	2.13	1.42	1.28	4.36	3.24
U	6032-15	2.35	2.77	2.37	8.92	4.50	2.23	2.37	2.57	7.82	4.00	2.13	1.99	2.73	6.96	3.74
V	7343-21	2.55	2.77	3.67	10.22	5.60	2.43	2.37	3.87	9.12	5.10	2.33	1.99	4.03	8.26	4.84
W	7343-15	2.55	2.77	3.67	10.22	5.60	2.43	2.37	3.87	9.12	5.10	2.33	1.99	4.03	8.26	4.84
X <sup>1</sup>	7343-43	2.55	2.77	3.67	10.22	5.60	2.43	2.37	3.87	9.12	5.10	2.33	1.99	4.03	8.26	4.84
Y <sup>1</sup>	7343-40	2.55	2.77	3.67	10.22	5.60	2.43	2.37	3.87	9.12	5.10	2.33	1.99	4.03	8.26	4.84

**Density Level A:** For low-density product applications. Recommended for wave solder applications and provides a wider process window for reflow solder processes.

**Density Level B:** For products with a moderate level of component density. Provides a robust solder attachment condition for reflow solder processes.

**Density Level C:** For high component density product applications. Before adapting the minimum land pattern variations the user should perform qualification testing based on the conditions outlined in IPC standard 7351 (IPC-7351).

<sup>1</sup> Height of these chips may create problems in wave soldering.



**Table 2 – Land Dimensions/Courtyard cont.**

T523 / T527

KEMET	Metric Size Code	Maximum (Most) Land Protrusion (mm)					Median (Nominal) Land Protrusion (mm)					Minimum (Least) Land Protrusion (mm)						
		Case	EIA	W	L	S	V1	V2	W	L	S	V1	V2	W	L	S	V1	V2
P	2012-10	1.05	1.76	0.21	4.74	2.36	0.93	1.36	0.41	3.64	1.86	0.83	0.98	0.57	2.93	1.6		
K	3528-10	2.35	2.04	1.24	6.32	4.00	2.23	1.64	1.44	5.22	3.50	2.13	1.26	1.60	4.52	3.24		
W	7343-15	2.55	2.77	3.67	10.22	5.60	2.43	2.37	3.87	9.12	5.10	2.33	1.99	4.03	8.26	4.84		
V	7343-20	2.55	2.77	3.67	10.22	5.60	2.43	2.37	3.87	9.12	5.10	2.33	1.99	4.03	8.26	4.84		
G	7360-12	4.60	3.07	3.07	10.22	7.30	4.48	2.67	3.27	9.12	6.80	4.38	2.29	3.43	8.26	6.54		
J	7360-15	4.60	3.07	3.07	10.22	7.30	4.48	2.67	3.27	9.12	6.80	4.38	2.29	3.43	8.26	6.54		
H	7360-20	4.60	3.07	3.07	10.22	7.30	4.48	2.67	3.27	9.12	6.80	4.38	2.29	3.43	8.26	6.54		

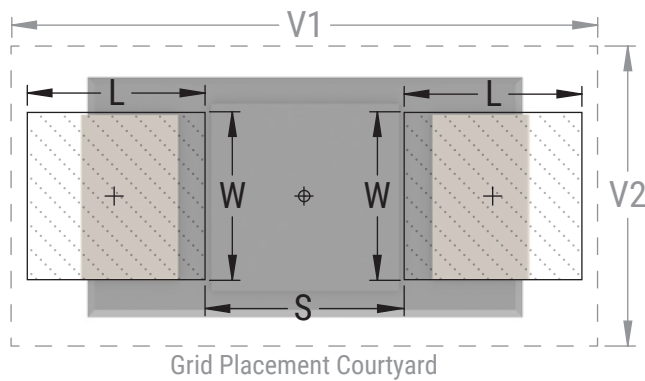

T527 / T529

KEMET	Metric Size Code	Dimensions (mm)			
		Minimum – Maximum			
Case	EIA	G	Z	X	Y
A08	3216-08	1.00 – 1.65	3.25 – 3.80	1.1 – 1.30	0.8 – 1.40
I	3216-10	1.00 – 1.65	3.25 – 3.80	1.10 – 1.30	0.80 – 1.40
S	3216-12	1.00 – 1.65	3.25 – 3.80	1.1 – 1.30	0.8 – 1.40
P	2012-10	0.40 – 1.05	2.05 – 2.60	0.80 – 1.00	0.5 – 1.1

(JEITA RC-2371 is recommended for reference)

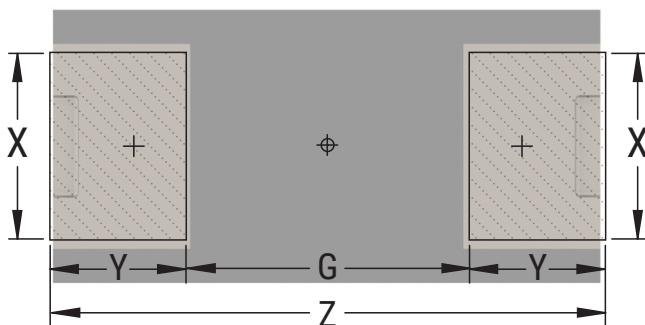

## Soldering Process

The KEMET families of surface mount capacitors are compatible with wave (single or dual), convection, IR, or vapor phase reflow techniques. Preheating of these components is recommended to avoid extreme thermal stress. KEMET's recommended profile conditions for convection and IR reflow reflect the profile conditions of the IPC/J-STD-020D standard for moisture sensitivity testing. The devices can safely withstand a maximum of three reflow passes at these conditions.

Please note that although the X/7343-43 case size can withstand wave soldering, the tall profile (4.3 mm maximum) dictates care in wave process development.

Hand soldering should be performed with care due to the difficulty in process control. If performed, care should be taken to avoid contact of the soldering iron to the molded case. The iron should be used to heat the solder pad, applying solder between the pad and the termination, until reflow occurs. Once reflow occurs, the iron should be removed immediately. "Wiping" the edges of a chip and heating the top surface is not recommended.

Profile Feature	SnPb Assembly	Pb-Free Assembly
<b>Preheat/Soak</b>		
Temperature Minimum ( $T_{smin}$ )	100°C	150°C
Temperature Maximum ( $T_{smax}$ )	150°C	200°C
Time ( $t_s$ ) from $T_{smin}$ to $T_{smax}$	60 – 120 seconds	60 – 120 seconds
Ramp-up Rate ( $T_L$ to $T_P$ )	3°C/seconds maximum	3°C/seconds maximum
Liquidous Temperature ( $T_L$ )	183°C	217°C
Time Above Liquidous ( $t_L$ )	60 – 150 seconds	60 – 150 seconds
Peak Temperature ( $T_P$ )	220°C* 235°C**	250°C* 260°C**
Time within 5°C of Maximum Peak Temperature ( $t_p$ )	20 seconds maximum	30 seconds maximum
Ramp-down Rate ( $T_P$ to $T_L$ )	6°C/seconds maximum	6°C/seconds maximum
Time 25°C to Peak Temperature	6 minutes maximum	8 minutes maximum

Note: All temperatures refer to the center of the package, measured on the package body surface that is facing up during assembly reflow.

\* For Case Size height > 2.5 mm

\*\* For Case Size height ≤ 2.5 mm

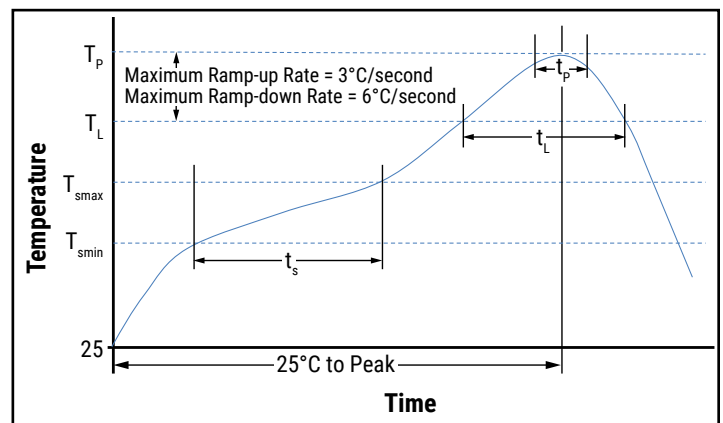

## Storage

All KO-Cap are shipped in moisture barrier bags (MBBs) with desiccant and humidity indicator card (HIC).

These parts are classified as moisture sensitivity level 3 (MSL3) or moisture sensitivity level 4 (MSL4) per IPC/JEDEC J-STD-020 and packaged per IPC/JEDEC J-STD-033. Refer to Table 1 for part type specification.

MSL3 specifies a floor time of 168H at 30°C maximum temperature and 60% relative humidity.

MSL4 specifies a floor time of 72H at 30°C maximum temperature and 60% relative humidity. Unused capacitors should be sealed in a MBB with fresh desiccant.

Calculated shelf life in sealed bag:

- 12 months from bag seal date in a storage environment of < 40°C and humidity < 90% RH

- 24 months from bag seal date in a storage environment of < 30°C and humidity < 70% RH

If baking is required, refer to IPC/JEDEC J-STD-033 for bake procedure

## Construction

### T520/T521/T525/T530

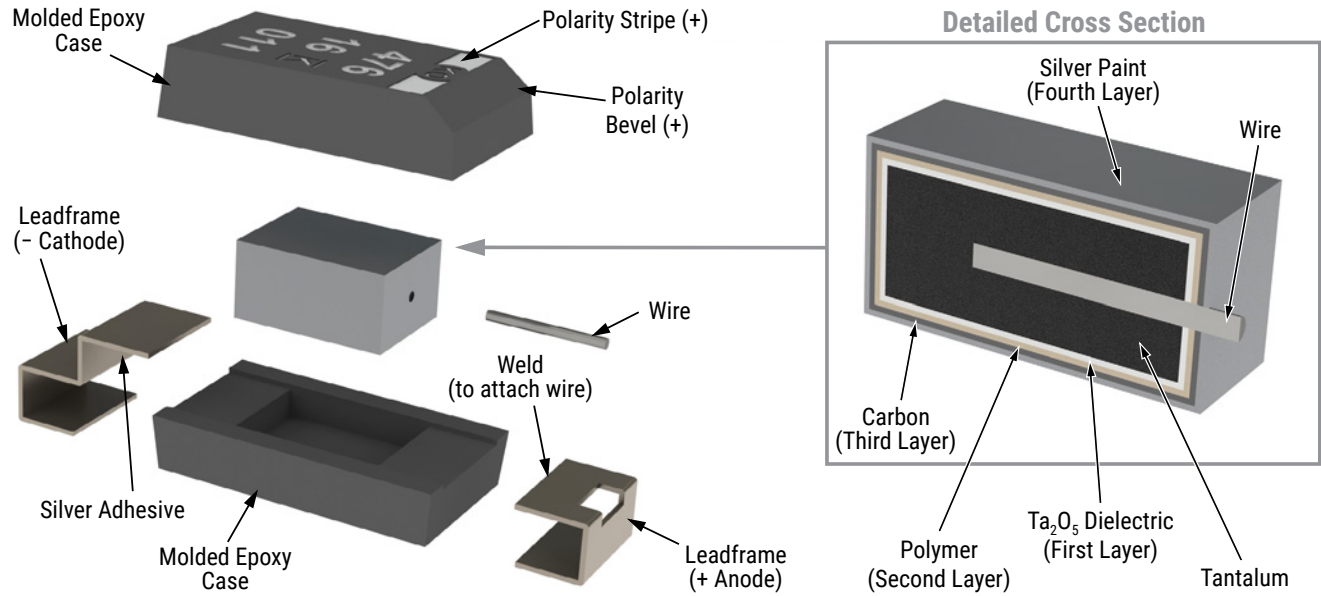

### T523

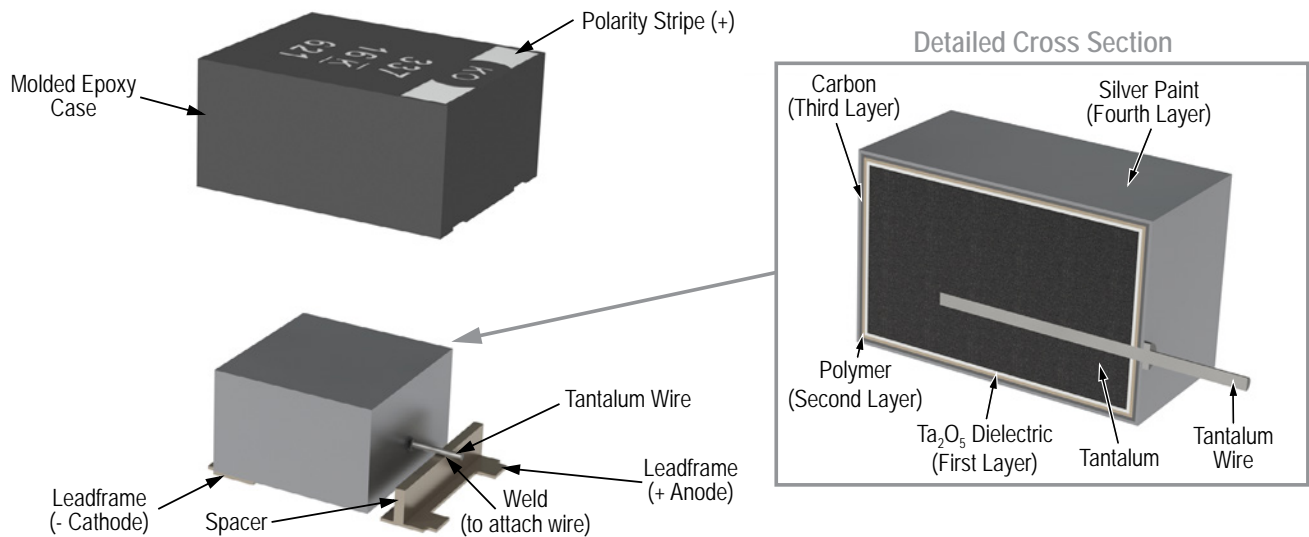

**Construction cont.**

**T527**

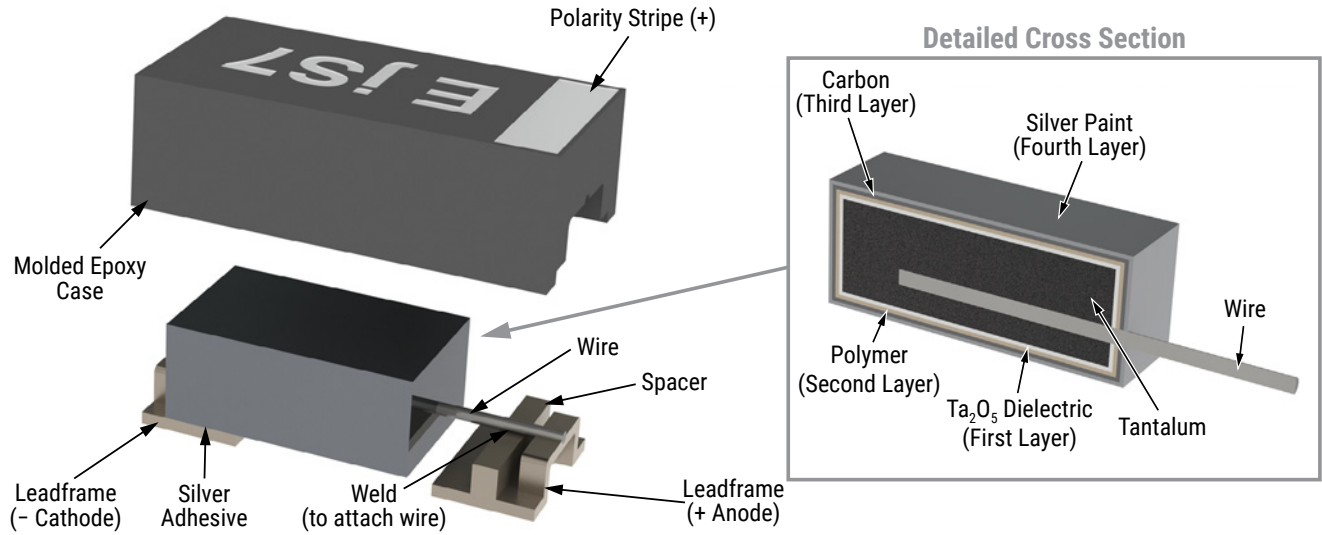

**T529**

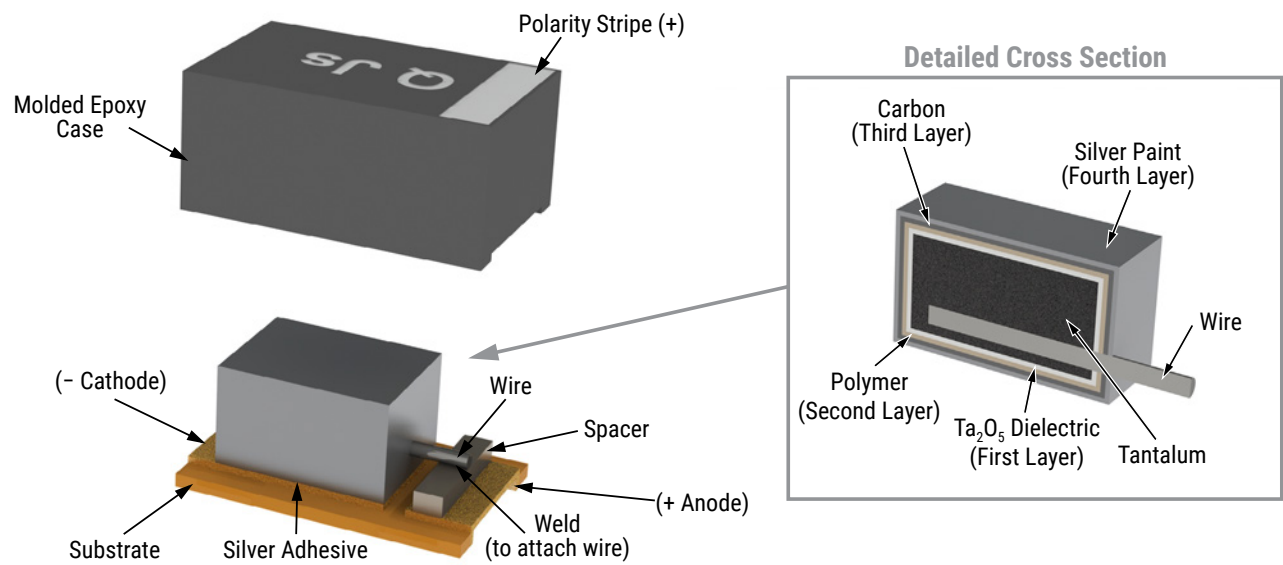

## Capacitor Marking

### T520/T521/T523/T525/T530

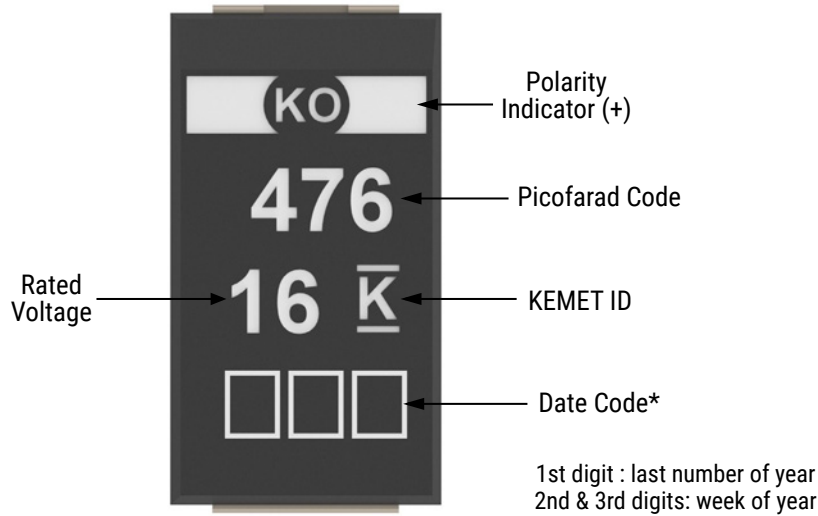

### T520A/T527I/T527S/T527T

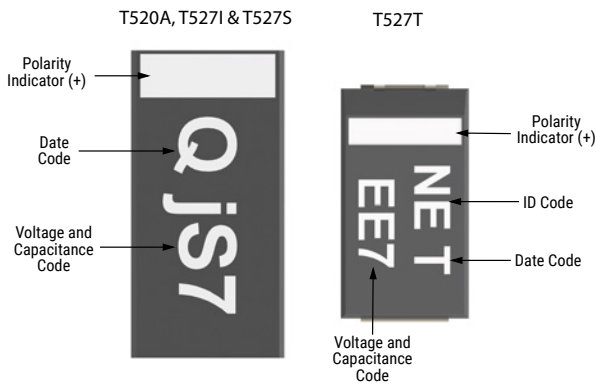

Code	e	g	j	A	C	E
Rated Voltage	2.5 V	4 V	6.3 V	10 V	16 V	25 V

Code	A7	E7	J7	N7
Capacitance	10	15	22	33

Code	S7	W7	A8	J8
Capacitance	47	68	100	220

Date Code*												
Year	Jan	Feb	Mar	Apr	May	Jun	Jul	Aug	Sep	Oct	Nov	Dec
2019	a	b	c	d	e	f	g	h	j	k	l	m
2020	n	p	q	r	s	t	u	v	w	x	y	z
2021	A	B	C	D	E	F	G	H	J	K	L	M
2022	N	P	Q	R	S	T	U	V	W	X	Y	Z
2023	a	b	c	d	e	f	g	h	j	k	l	m
2024	n	p	q	r	s	t	u	v	w	x	y	z

## Capacitor Marking cont.

### T520B/T521B/T520T

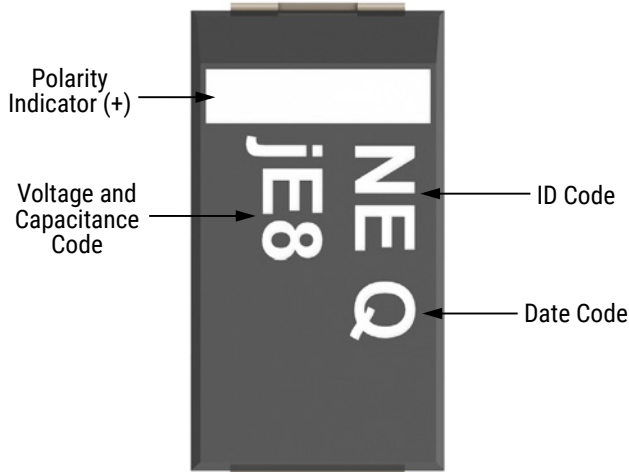

Code	e	g	J	A	C	D	E
Rated Voltage	2.5 V	4 V	6.3 V	10 V	16 V	20 V	25 V

Code	E7	J7	N7	A8
Capacitance	15	22	33	100

Code	E8	J8	N8	S8
Capacitance	150	220	330	470

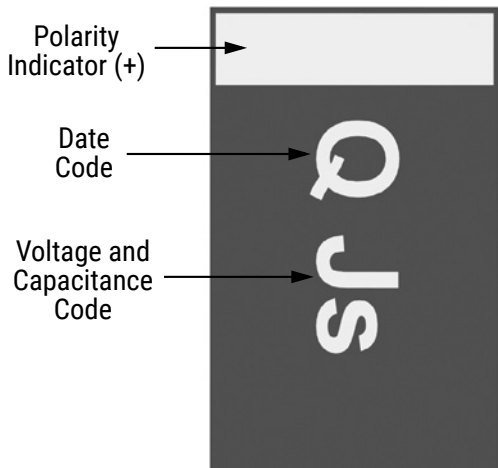

### T529

Code	J	A	C	E
Rated Voltage	6.3 V	10 V	16 V	25 V

Code	S	a	j	s
Capacitance (µF)	4.7	10	22	47

Date Code*												
Year	Jan	Feb	Mar	Apr	May	Jun	Jul	Aug	Sep	Oct	Nov	Dec
2018	N	P	Q	R	S	T	U	V	W	X	Y	Z
2019	a	b	c	d	e	f	g	h	j	k	l	m
2020	n	p	q	r	s	t	u	v	w	x	y	z
2021	A	B	C	D	E	F	G	H	J	K	L	M
2022	N	P	Q	R	S	T	U	V	W	X	Y	Z
2023	a	b	c	d	e	f	g	h	j	k	l	m

## Tape & Reel Packaging Information

KEMET's molded chip capacitor families are packaged in 8 and 12 mm plastic tape on 7" and 13" reels in accordance with *EIA Standard 481: Embossed Carrier Taping of Surface Mount Components for Automatic Handling*. This packaging system is compatible with all tape-fed automatic pick-and-place systems.

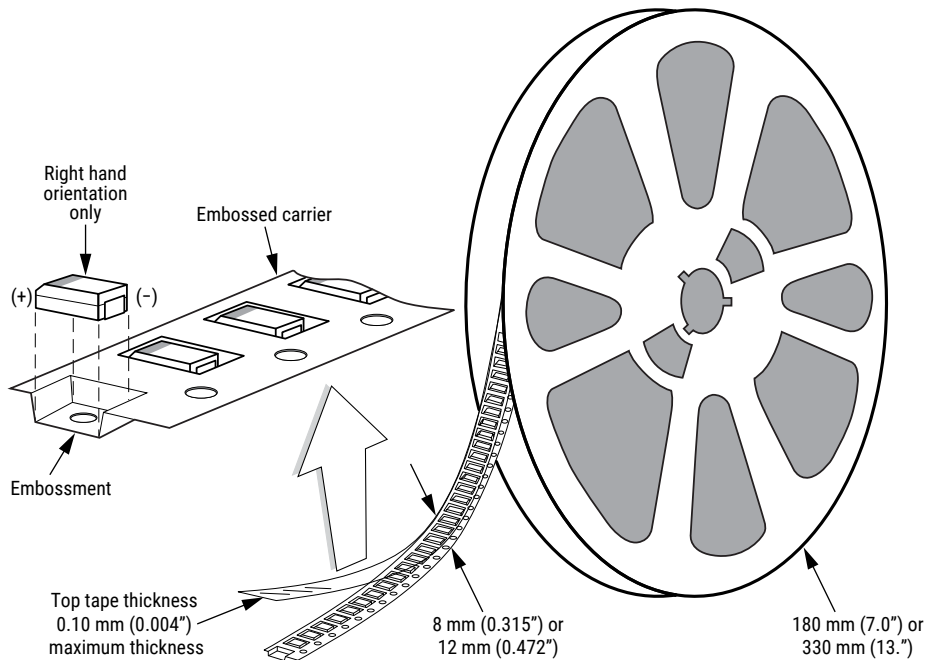
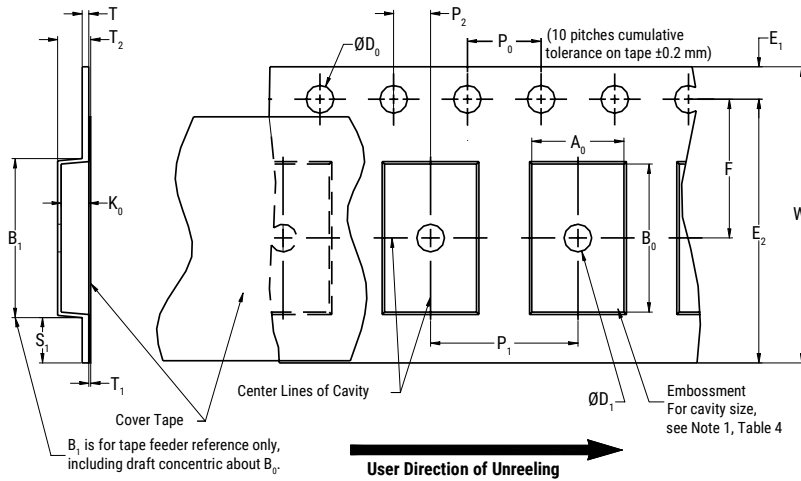

**Table 3 – Packaging Quantity**

Case Code		Tape Width (mm)	7" Reel*	13" Reel*
KEMET	EIA			
P	2012-10	8	3,000	N/A
R	2012-12	8	2,500	10,000
08A	3216-08	8	3,000	N/A
I	3216-10	8	3,000	N/A
S	3216-12	8	3,000	N/A
A	3216-18	8	2,000	N/A
K	3528-10	8	3,000	N/A
T	3528-12	8	3,000	10,000
M	3528-15	8	2,500	8,000
B	3528-21	8	2,000	8,000
U	6032-15	12	1,000	5,000
L	6032-19	12	1,000	3,000
C	6032-28	12	500	3,000
Q	7343-12	12	1,000	3,000
W	7343-15	12	1,000	3,000
Z	7343-17	12	1,000	3,000
V	7343-19	12	1,000	3,000
D	7343-31	12	500	2,500
Y	7343-40	12	500	2,000
X	7343-43	12	500	2,000
J	7360-15	12	1,000	3,000
H	7360-20	12	1,000	3,000
O	7360-43	12	250	1,000

\* No Co-Spec required for 7" reel packaging. C-7280 required for 13" reel packaging.

**Figure 1 – Embossed (Plastic) Carrier Tape Dimensions**



**Table 4 – Embossed (Plastic) Carrier Tape Dimensions**

Metric will govern

Constant Dimensions – Millimeters (Inches)									
Tape Size	D <sub>0</sub>	D <sub>1</sub> Minimum Note 1	E <sub>1</sub>	P <sub>0</sub>	P <sub>2</sub>	R Reference Note 2	S <sub>1</sub> Minimum Note 3	T Maximum	T <sub>1</sub> Maximum
8 mm	1.5 +0.10/-0.0 (0.059 +0.004/-0.0)	1.0 (0.039)	1.75 ±0.10 (0.069 ±0.004)	4.0 ±0.10 (0.157 ±0.004)	2.0 ±0.05 (0.079 ±0.002)	25.0 (0.984)	0.600 (0.024)	0.600 (0.024)	0.100 (0.004)
12 mm		1.5 (0.059)							

Variable Dimensions – Millimeters (Inches)									
Tape Size	Pitch	B <sub>1</sub> Maximum Note 4	E <sub>2</sub> Minimum	F	P <sub>1</sub>	T <sub>2</sub> Maximum	W Maximum	A <sub>0</sub> , B <sub>0</sub> & K <sub>0</sub>	
8 mm	Single (4 mm)	4.35 (0.171)	6.25 (0.246)	3.5 ±0.05 (0.138 ±0.002)	4.0 ±0.10 (0.157 ±0.004)	2.5 (0.098)	8.3 (0.327)	Note 5	
12 mm	Single (4 mm) and Double (8 mm)	8.2 (0.323)	10.25 (0.404)	5.5 ±0.05 (0.217 ±0.002)	8.0 ±0.10 (0.315 ±0.004)	4.6 (0.181)	12.3 (0.484)		

1. The embossment hole location shall be measured from the sprocket hole controlling the location of the embossment. Dimensions of embossment location and hole location shall be applied independent of each other.
2. The tape, with or without components, shall pass around R without damage (see Figure 4).
3. If S<sub>1</sub> < 1.0 mm, there may not be enough area for cover tape to be properly applied (see EIA Standard 481-D, paragraph 4.3, section b).
4. B<sub>1</sub> dimension is a reference dimension for tape feeder clearance only.
5. The cavity defined by A<sub>0</sub>, B<sub>0</sub> and K<sub>0</sub> shall surround the component with sufficient clearance that:
  - (a) the component does not protrude above the top surface of the carrier tape.
  - (b) the component can be removed from the cavity in a vertical direction without mechanical restriction, after the top cover tape has been removed.
  - (c) rotation of the component is limited to 20° maximum for 8 and 12 mm tapes (see Figure 2).
  - (d) lateral movement of the component is restricted to 0.5 mm maximum for 8 mm and 12 mm wide tape (see Figure 3).
  - (e) see Addendum in EIA Standard 481-D for standards relating to more precise taping requirements.

## Packaging Information Performance Notes

- Cover Tape Break Force:** 1.0 Kg minimum.
- Cover Tape Peel Strength:** The total peel strength of the cover tape from the carrier tape shall be:

Tape Width	Peel Strength
8 mm	0.1 to 1.0 Newton (10 to 100 gf)
12 mm	0.1 to 1.3 Newton (10 to 130 gf)

The direction of the pull shall be opposite the direction of the carrier tape travel. The pull angle of the carrier tape shall be 165° to 180° from the plane of the carrier tape. During peeling, the carrier and/or cover tape shall be pulled at a velocity of 300 ±10 mm/minute.

- Labeling:** Bar code labeling (standard or custom) shall be on the side of the reel opposite the sprocket holes. Refer to EIA Standards 556 and 624.

### Figure 2 – Maximum Component Rotation

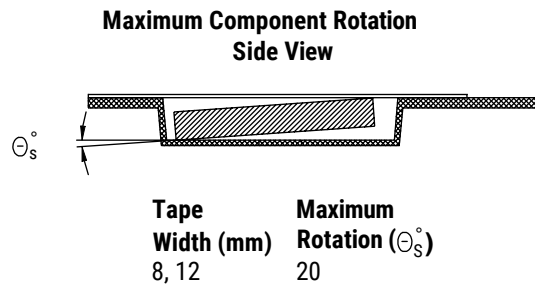
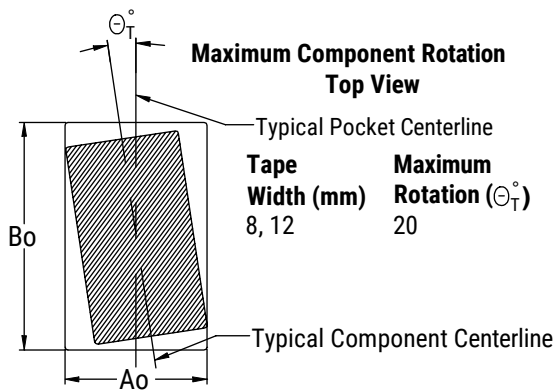

### Figure 3 – Maximum Lateral Movement

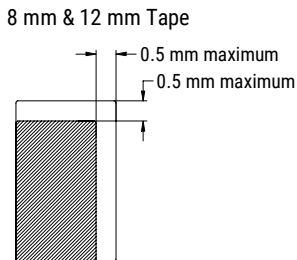

### Figure 4 – Bending Radius

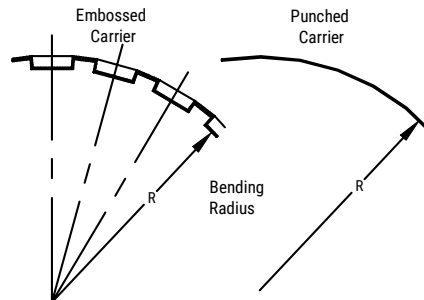

## Figure 5 – Reel Dimensions

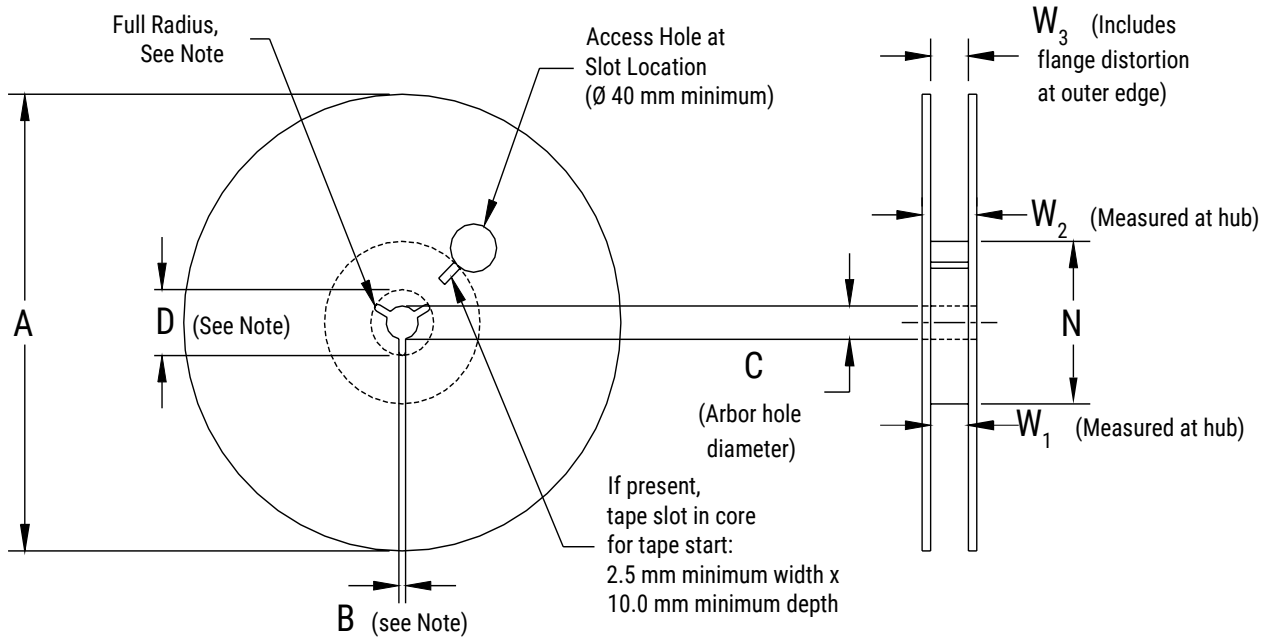

Note: Drive spokes optional; if used, dimensions B and D shall apply.

## Table 5 – Reel Dimensions

Metric will govern

Constant Dimensions – Millimeters (Inches)				
Tape Size	A	B Minimum	C	D Minimum
8 mm	178 ±0.20 (7.008 ±0.008)	1.5 (0.059)	13.0 +0.5/-0.2 (0.521 +0.02/-0.008)	20.2 (0.795)
12 mm	330 ±0.20 (13.000 ±0.008)			
Variable Dimensions – Millimeters (Inches)				
Tape Size	N Minimum	W <sub>1</sub>	W <sub>2</sub> Maximum	W <sub>3</sub>
8 mm	50 (1.969)	8.4 +1.5/-0.0 (0.331 +0.059/-0.0)	14.4 (0.567)	Shall accommodate tape width without interference
12 mm		12.4 +2.0/-0.0 (0.488 +0.078/-0.0)	18.4 (0.724)	

**Figure 6 – Tape Leader & Trailer Dimensions**

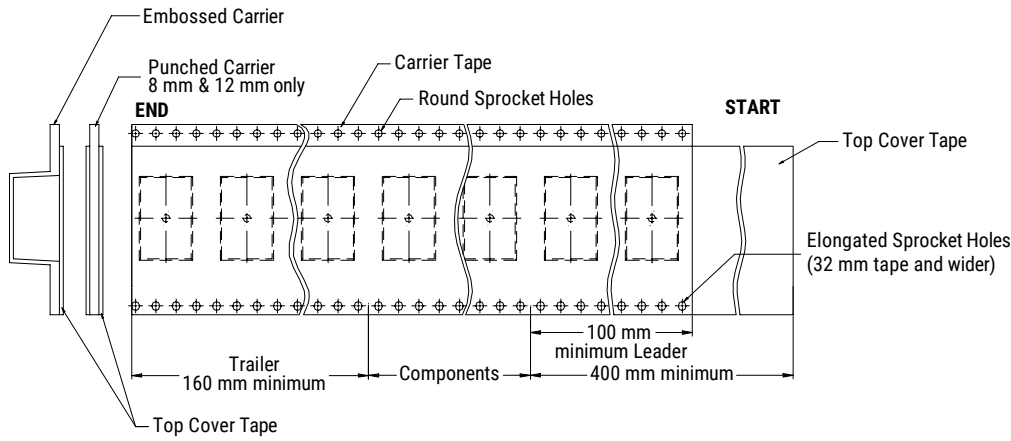

**Figure 7 – Maximum Camber**

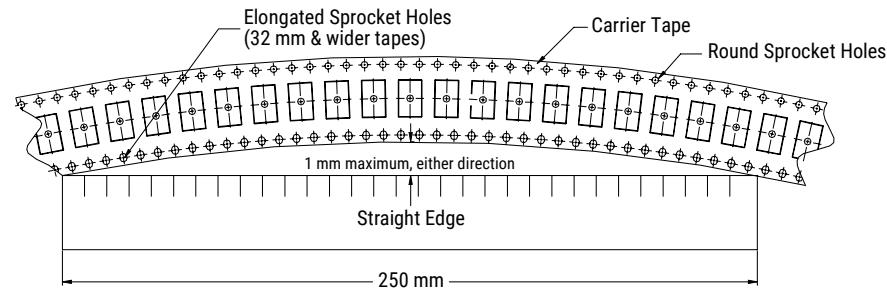

## KEMET Electronics Corporation Sales Offices

For a complete list of our global sales offices, please visit [www.kemet.com/sales](http://www.kemet.com/sales).

---

### Disclaimer

YAGEO Corporation and its affiliates do not recommend the use of commercial or automotive grade products for high reliability applications or manned space flight.

All product specifications, statements, information and data (collectively, the "Information") in this datasheet are subject to change. The customer is responsible for checking and verifying the extent to which the Information contained in this publication is applicable to an order at the time the order is placed. All Information given herein is believed to be accurate and reliable, but it is presented without guarantee, warranty, or responsibility of any kind, expressed or implied.

Statements of suitability for certain applications are based on KEMET Electronics Corporation's ("KEMET") knowledge of typical operating conditions for such applications, but are not intended to constitute – and KEMET specifically disclaims – any warranty concerning suitability for a specific customer application or use. The Information is intended for use only by customers who have the requisite experience and capability to determine the correct products for their application. Any technical advice inferred from this Information or otherwise provided by KEMET with reference to the use of KEMET's products is given gratis, and KEMET assumes no obligation or liability for the advice given or results obtained.

Although KEMET designs and manufactures its products to the most stringent quality and safety standards, given the current state of the art, isolated component failures may still occur. Accordingly, customer applications which require a high degree of reliability or safety should employ suitable designs or other safeguards (such as installation of protective circuitry or redundancies) in order to ensure that the failure of an electrical component does not result in a risk of personal injury or property damage.

Although all product-related warnings, cautions and notes must be observed, the customer should not assume that all safety measures are indicated or that other measures may not be required.

*KEMET is a registered trademark of KEMET Electronics Corporation.*

## Looking for pricing, stock, or lifecycle information?

Click below to explore more details on WIN SOURCE:

 [View T529P476M006AAE200 on WIN SOURCE](#)

 [Kemet Information](#)

## Optimize Your Supply Chain with WIN SOURCE Solutions

-  Global Sourcing Solution
-  Obsolete Management
-  Cost Control Management
-  Shortage Management
-  Alternative Solution
-  Excess Inventory Management