



**THE DATASHEET OF
RSF200JB-73-2R7**



DATA SHEET

METAL OXIDE FILM RESISTORS

General Purpose, Flameproof

RSF Series

$\pm 2\%$, $\pm 5\%$

1/4W to 5W

RoHS compliant & Halogen Free



DIMENSIONS

Unit: mm

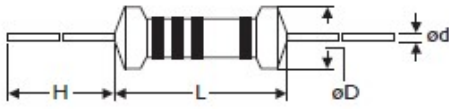

Normal	Miniature	L	ψD	H	ψd
RSF-50	RSF1WS	9.0 ± 0.5	3.3 ± 0.3	26 ± 2.0	0.55 ± 0.05
RSF100	RSF2WS	11.5 ± 1.0	4.5 ± 0.5	35 ± 2.0	0.8 ± 0.05
RSF200	RSF3WS	15.5 ± 1.0	5.0 ± 0.5	33 ± 2.0	0.8 ± 0.05
RSF3WM	RSF5SS	17.5 ± 1.0	6.5 ± 1.0	32 ± 2.0	0.8 ± 0.05
RSF300	RSF5WS	24.5 ± 1.0	8.5 ± 1.0	38 ± 2.0	0.8 ± 0.05
RSF500	-	24.5 ± 1.0	8.5 ± 1.0	38 ± 2.0	0.8 ± 0.05

DERATING CURVE

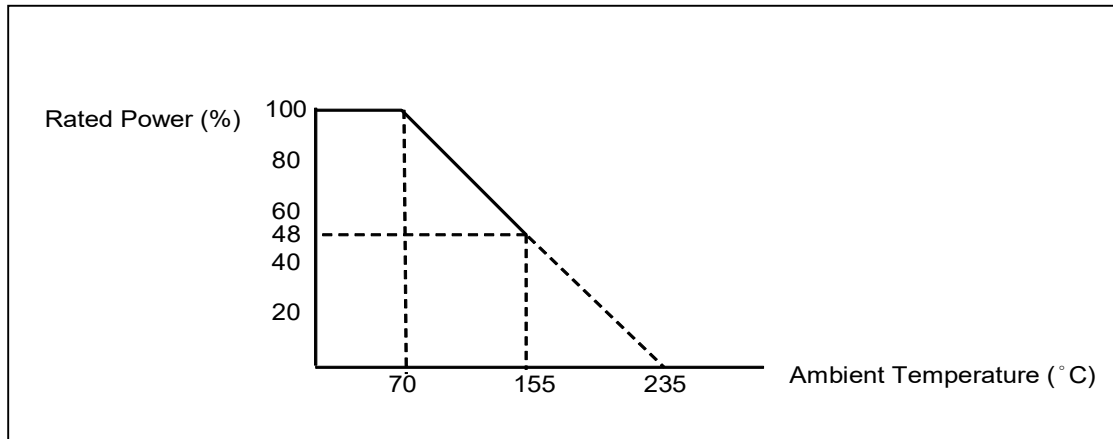

ELECTRICAL CHARACTERISTICS

CHARACTERISTICS	RSF-50	RSF100	RSF200	RSF3WM	RSF300	RSF500
Power Rating at 70 °C	1/2W	1W	2W	3W	3W	5W
Maximum working voltage	250V	350V	350V	450V	500V	750V
Maximum overload voltage	400V	600V	600V	700V	800V	1000V
Voltage Proof on Insulation	350V	500V	500V	500V	500V	500V
Resistance Range	1Ω – 1MΩ for E24 series value					
Operating Temp. Range	- 55°C to +155°C					
Temperature Coefficient	±300ppm/°C					

Note: For resistance value out of above range is by request. Below 10Ω and over 20K(excluded) are using alloy film

CHARACTERISTICS	RSF1WS	RSF2WS	RSF3WS	RSF5SS	RSF5WS
Power Rating at 70 °C	1W	2W	3W	5W	5W
Maximum working voltage	300V	350V	350V	500V	700V
Maximum overload voltage	500V	600V	600V	800V	900V
Voltage Proof on Insulation	400V	500V	500V	500V	500V
Resistance Range	1Ω – 1MΩ for E24 series value				
Operating Temp. Range	- 55°C to +155°C				
Temperature Coefficient	±300ppm/°C				

Note: For resistance value out of above range is by request. Below 10Ω and over 20K(excluded) are using alloy film

TEST AND REQUIREMENTS

TEST	TEST METHOD	PROCEDURE	APPRAISE
Short Time Overload	IEC 60115-1 4.13	2.5 times RCWV for 5 sec. (Not more than maximum overload voltage)	±1%+0.05Ω for normal style ±2%+0.05Ω for miniature style
Voltage Proof on Insulation	IEC 60115-1 4.7	In V-Block for 60 sec. test voltage as above table	No Breakdown
Temperature Coefficient	IEC 60115-1 4.8	Between -55°C to +155°C	By Type
Insulation Resistance	IEC 60115-1 4.6	In V-Block for 60 sec.	>1,000MΩ
Solderability	IEC 60115-1 4.17	245±5°C for 3±0.5 Sec.	95% Min. coverage
Solvent Resistance of Marking	IEC 60115-1 4.30	IPA for 5±0.5 Min. with ultrasonic	No deterioration of coatings and markings
Robustness of Terminations	IEC 60115-1 4.16	Direct load for 10 Sec. in the direction of the terminal leads	≥2.5Kg(24.5N)
Periodic-pulse Overload	IEC 60115-1 4.39	4 times RCWV 10,000 cycles (1 Sec. on, 25 Sec. off)	±2.0%+0.05Ω
Damp Heat Steady State	IEC 60115-1 4.24	40±2°C, 90-95% RH for 56 days, loaded with 0.1 times RCWV	±5.0%+0.05Ω
Endurance at 70°C	IEC 60115-1 4.25	70±2°C at RCWV(or Umax., whichever less) for 1,000 Hr.(1.5 Hr.on, 0.5 Hr. off)	±5.0%+0.05Ω
Temperature Cycling	IEC 60115-1 4.19	→ -55°C → Room Temp. → +155°C Room Temp.(5 cycles)	±1.0%+0.05Ω
Resistance to Soldering Heat	IEC 60115-1 4.18	260±3°C for 10±1 Sec., immersed to a point 3±0.5mm from the body	±1.0 %+0.05Ω
Accidental Overload Test	IEC 60115-1 4.26	4 times RCWV for 1 Min.	No evidence of flaming or arcing

Note:

RCWV (Rated Continuous Working Voltage):

The DC or AC (rms) continuous working voltage corresponding to the rated power is determined by the following formula:

$$V = \sqrt{P \times R}$$

or max. working voltage whichever is less

Where

V=Continuous rated DC or
AC (rms) working voltage (V)

P=Rated power (W)

R=Resistance value (Ω)

PULSE DIAGRAMS

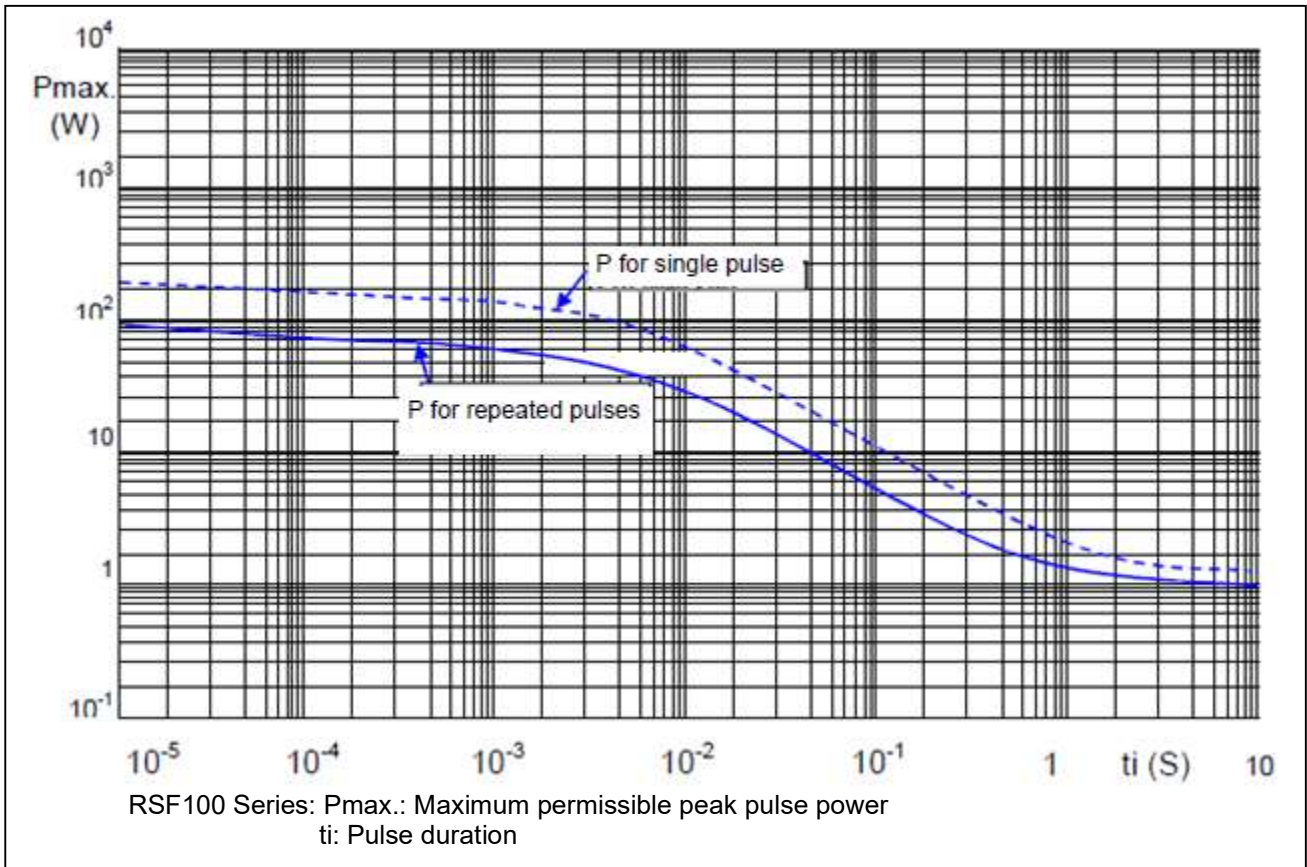
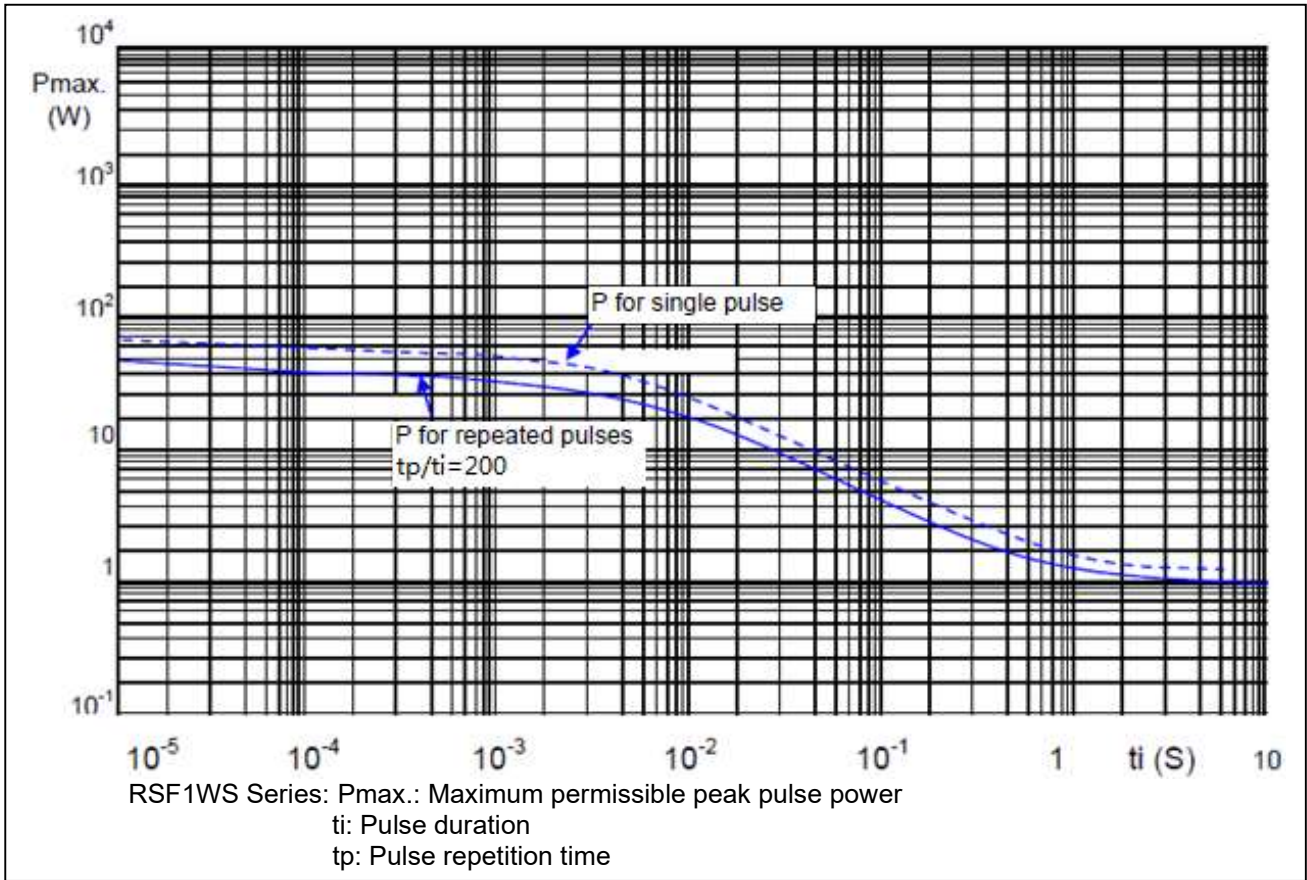

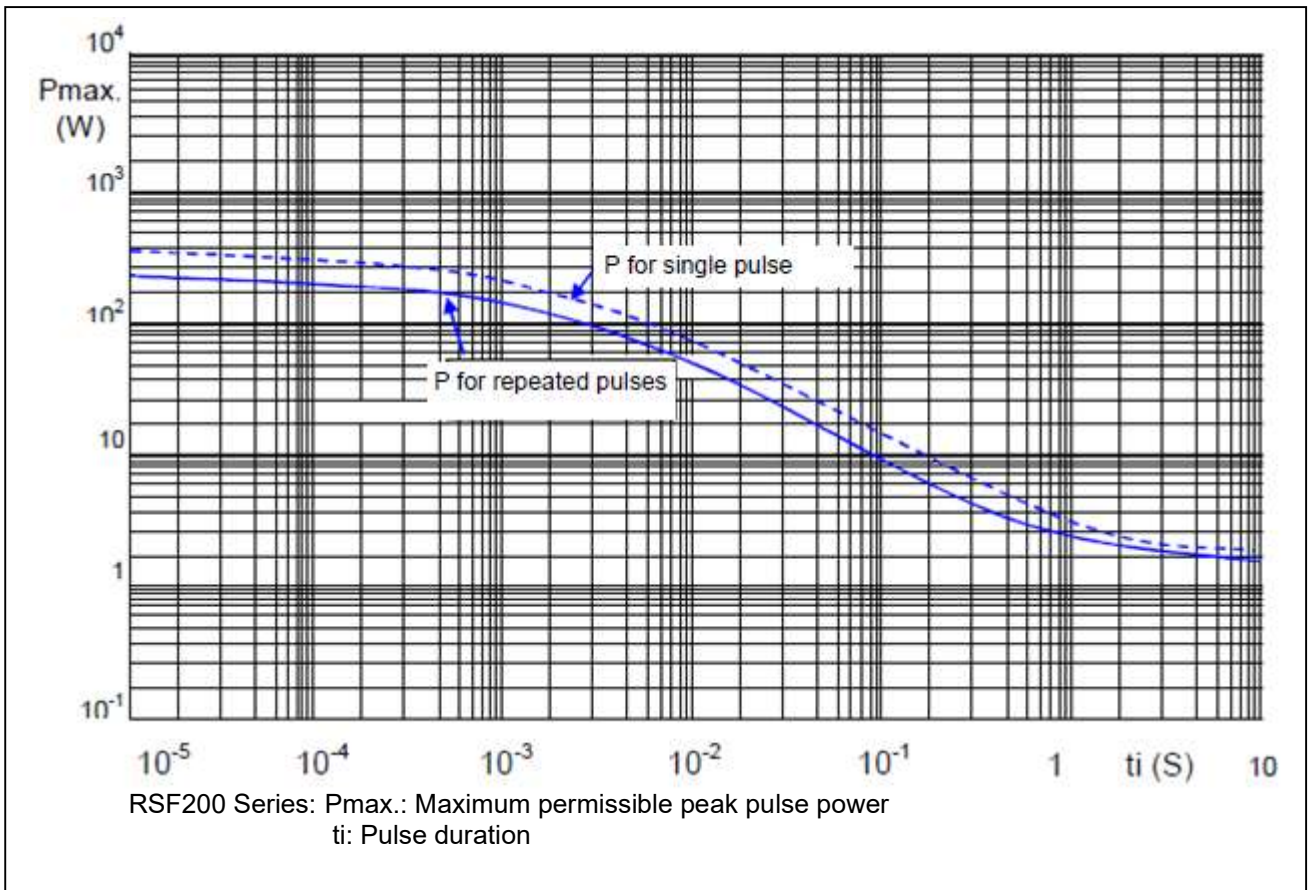
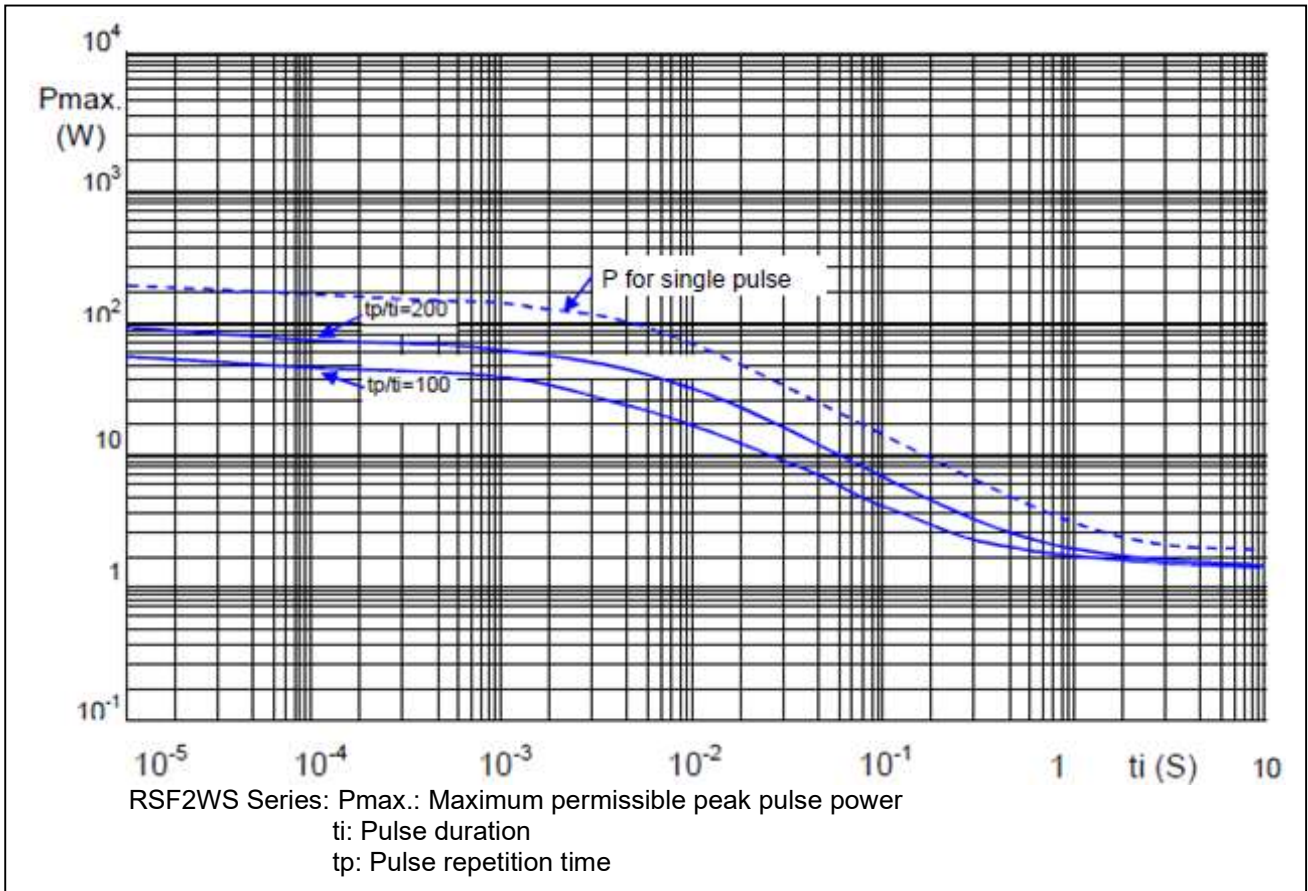

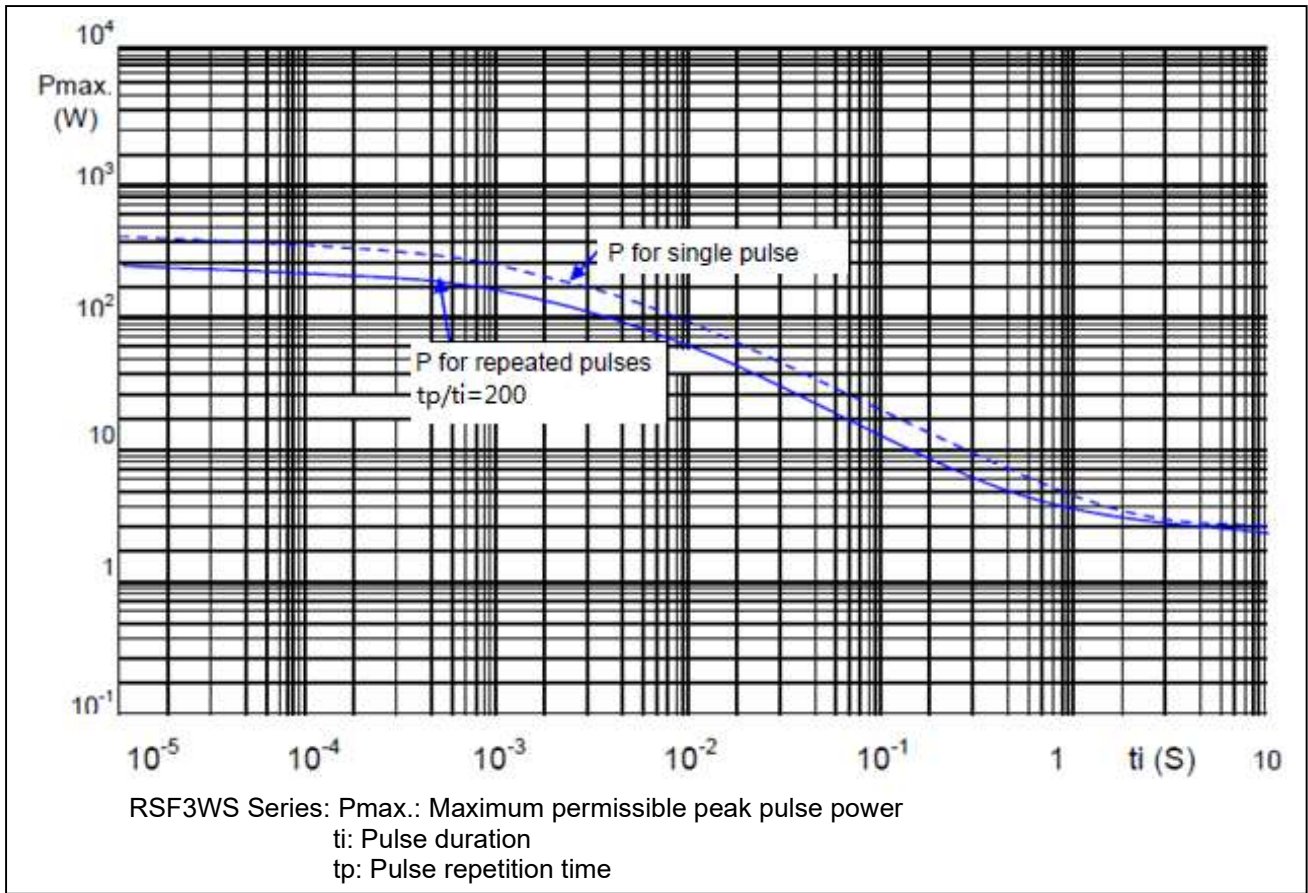

AXIAL / REEL TAPE SPECIFICATION

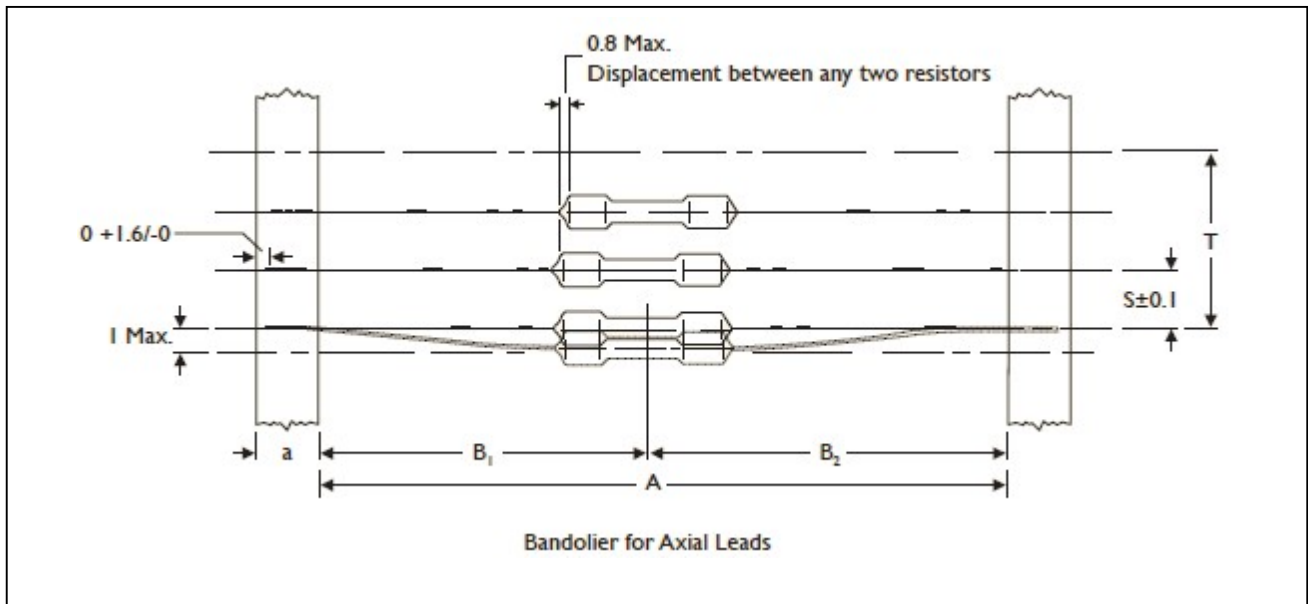

Unit: mm

Normal	Miniature	a	A	B1-B2 (Max.)	S (spacing)	T (max. deviation of spacing)
RSF-50	RSF1WS	6 ± 0.5	52.4 ± 1.5	1.2	5	1 mm per 10 spacing, 0.5 mm per 5 spacing
RSF100	RSF2WS	6 ± 0.5	73.0 ± 1.5 52.4 ± 1.5	1.5 1.2	5	
RSF200	RSF3WS	6 ± 0.5	73.0 ± 1.5 52.4 ± 1.5	1.5 1.2	10	
RSF3WM	RSF5SS	6 ± 0.5	73.0 ± 1.5	1.5	10	
RSF300	RSF5WS	6 ± 0.5	91.0 ± 1.5	1.5	10	
RSF500	-	6 ± 0.5	91.0 ± 1.5	1.5	10	

TAPE ON REEL PACKING

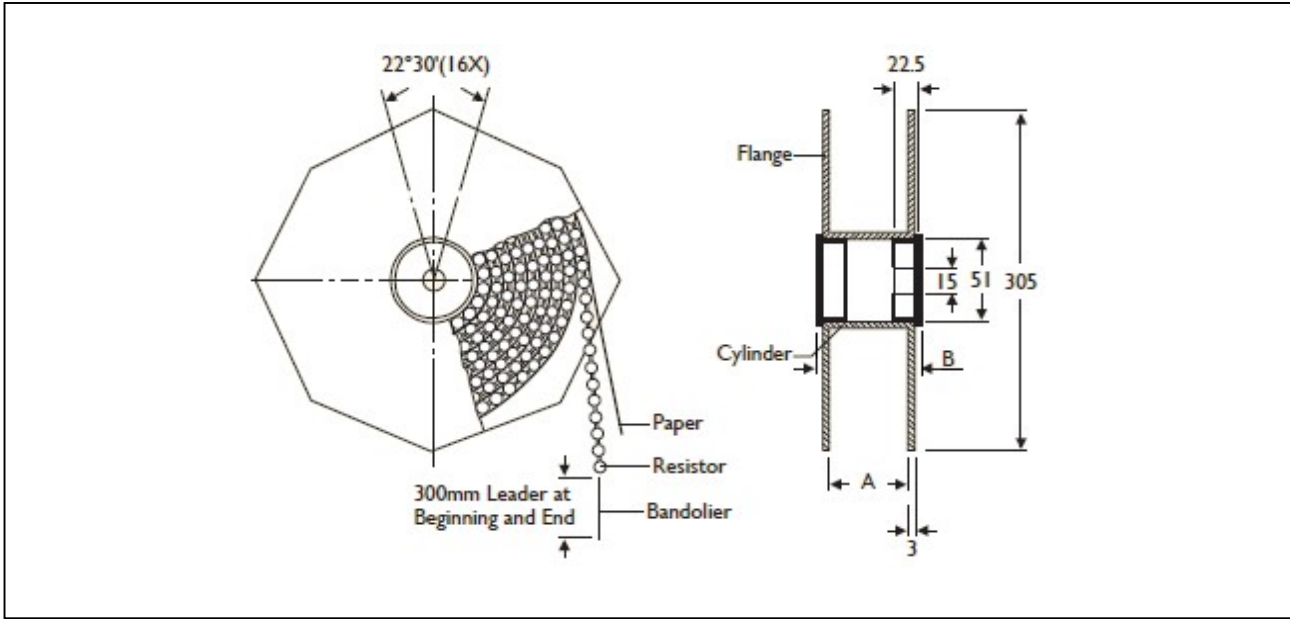

TYPE

Unit: mm/piece

Normal	Miniature	Across Flange(A)	B	Quantity Per Reel
RSF-50	RSF1WS	66.5	75.5	2,500
RSF100	RSF2WS	87	96	2,000
RSF200	RSF3WS	87	96	1,000
RSF3WM	RSF5SS	87	96	1,000

TAPE ON BOX PACKING

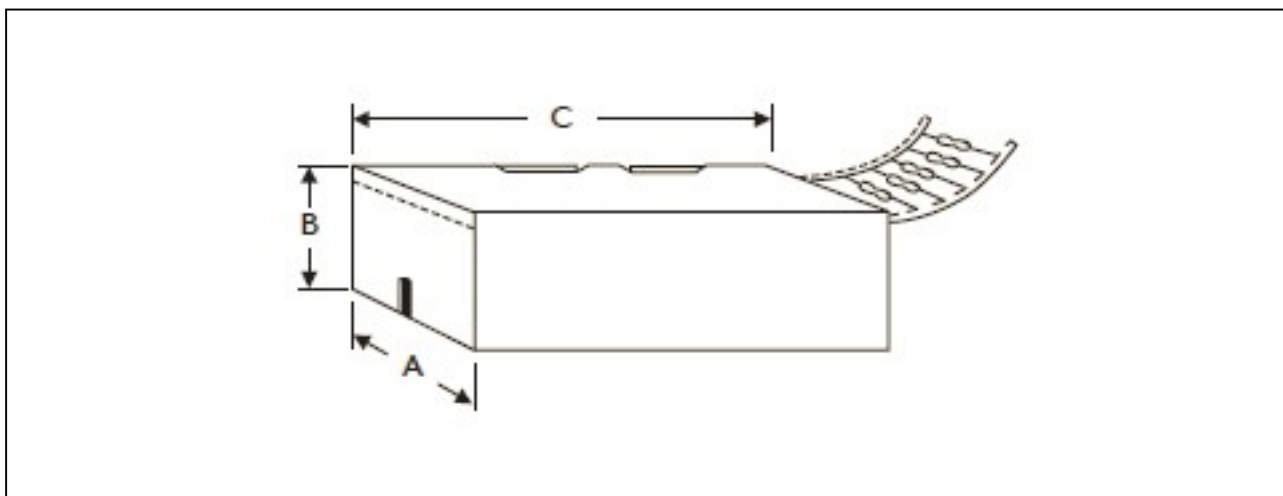

TYPE		DIMENSIONS			Unit: mm/piece
Normal	Miniature	A	B	C	Quantity Per Box
RSF-50	RSF1WS	73	45	258	1,000
RSF100	RSF2WS	81	91	260	1,000
RSF100	RSF2WS	103	78	260	1,000
RSF200	RSF3WS	81	91	260	1,000
RSF200	RSF3WS	103	94	260	1,000
RSF3WM	RSF5SS	103	78	260	500
RSF300	RSF5WS	116	79	255	250
RSF500	-	116	79	255	250

BULK PACKING

Normal	Miniature	Piece/Per Inner Box	Bag/Per Inner Box	Piece Per Bag
RSF-50	RSF1WS	5,000	5	1,000
RSF100	RSF2WS	2,000	4	500
RSF200	RSF3WS	1,000	2	500
RSF3WM	RSF5SS	1,000	2	500
RSF300	RSF5WS	500	10	50
RSF500	-	500	10	50

FORMING

M TYPE

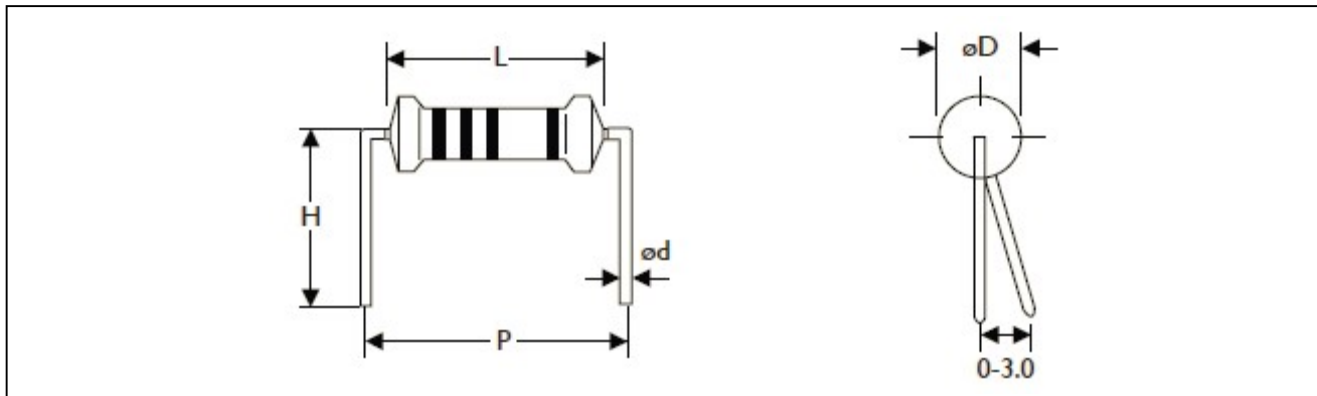

TYPE		DIMENSIONS					Unit: mm
Normal	Miniature	L	ψD	ψd	P	H	
RSF-50	RSF1WS	9.0 ± 0.5	3.3 ± 0.3	0.55 ± 0.05	12.5 ± 1	10.0 ± 1	
RSF100	RSF2WS	11.5 ± 1.0	4.5 ± 0.5	0.8 ± 0.05	15.0 ± 1	12.5 ± 1	
RSF200	RSF3WS	15.5 ± 1.0	5.0 ± 0.5	0.8 ± 0.05	20.0 ± 1	15.0 ± 1	
RSF3WM	RSF5SS	17.5 ± 1.0	6.5 ± 1.0	0.8 ± 0.05	25.0 ± 1	15.0 ± 1	

MB TYPE

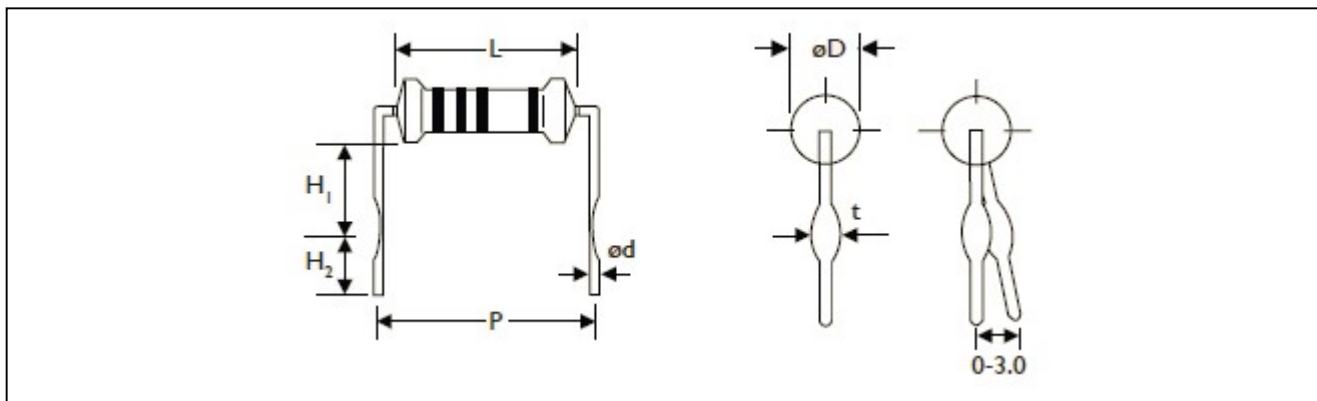

TYPE		DIMENSIONS							Unit: mm
Normal	Miniature	L	ψD	ψd	P	H1	H2	t	
RSF-50	-	9.0 ± 0.5	3.3 ± 0.3	0.55 ± 0.05	12.5 ± 1	6.0 ± 1	5.0 ± 1	1.2 ± 0.2	
-	RSF1WS	9.0 ± 0.5	3.3 ± 0.3	0.8 ± 0.05	12.5 ± 1	6.0 ± 1	5.0 ± 1	1.4 ± 0.2	
RSF100	RSF2WS	11.5 ± 1.0	4.5 ± 0.5	0.8 ± 0.05	15.0 ± 1	6.0 ± 1	5.0 ± 1	1.4 ± 0.2	
RSF200	RSF3WS	15.5 ± 1.0	5.0 ± 0.5	0.8 ± 0.05	20.0 ± 1	10.0 ± 1	5.0 ± 1	1.4 ± 0.2	
RSF3WM	RSF5SS	17.5 ± 1.0	6.5 ± 1.0	0.8 ± 0.05	25.0 ± 1	10.0 ± 1	5.0 ± 1	1.4 ± 0.2	

MHA TYPE

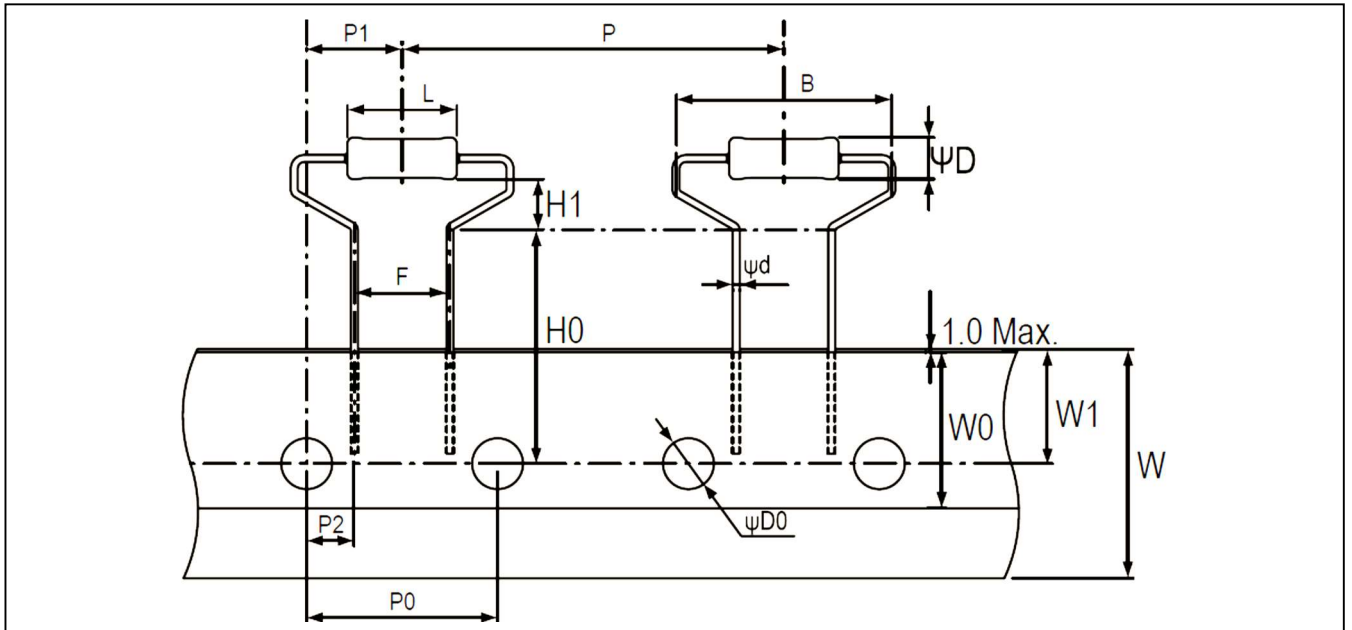

TYPE		DIMENSIONS								Unit: mm
Normal	Miniature	L	ψD	ψd	B	H0	H1	P	P0	
		9.0±0.5	3.3±0.3	0.55±0.05	17.5Max	19.0±1.0	4.0±1.0	30.0±1.0	15.0±0.3	
RSF-50	RSF1WS	P1	P2	F	W	W0	W1	$\psi D0$		
		7.5±1.0	3.75±0.5	7.5±0.5	18.0±0.5	5.0Min	9.0±0.5	4.0±0.2		

MHB TYPE

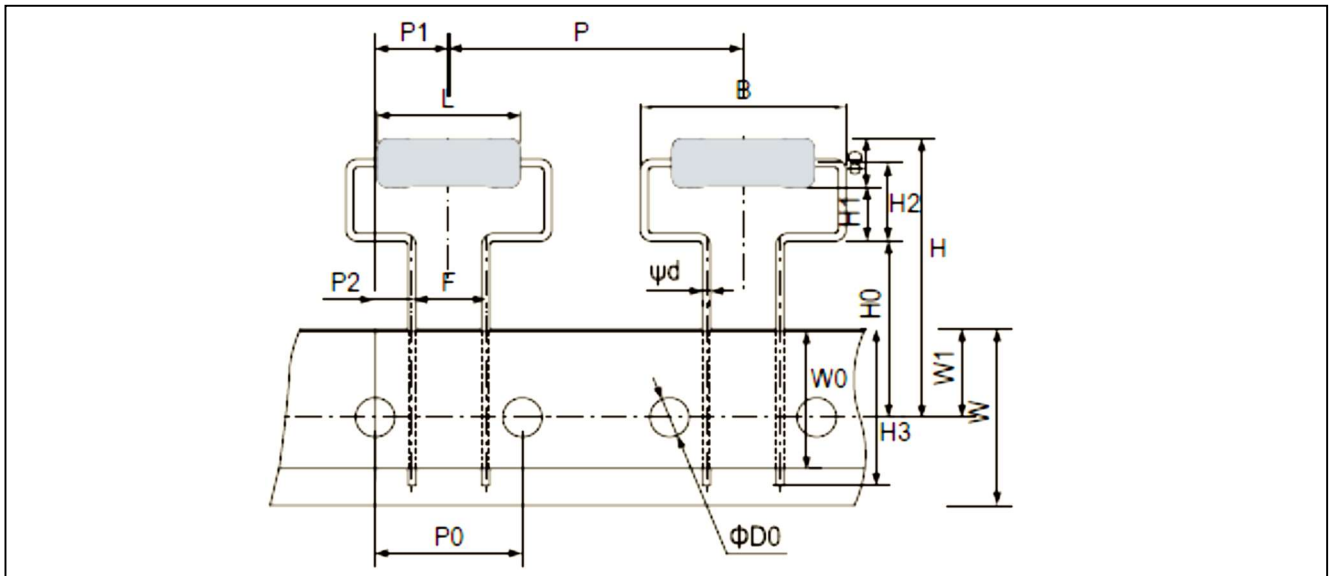

TYPE		DIMENSIONS									Unit: mm
Normal	Miniature	L	ψD	ψd	B	H	H0	H1	H2	H3	
		15.5±1.0	5.0±0.5	0.8±0.05	21.0Max.	30Max.	18.0±1.0	5.5(Ref.)	8.0±1.5	16Max.	
RSF200	RSF3WS	P	P0	P1	P2	F	W	W0	W1	$\psi D0$	
		30.0±1.0	15.0±0.3	7.5±1.0	3.75±0.8	7.5±0.5	18.0±0.5	5.0Min.	9.0±0.5	4.0±0.3	

MHC TYPE

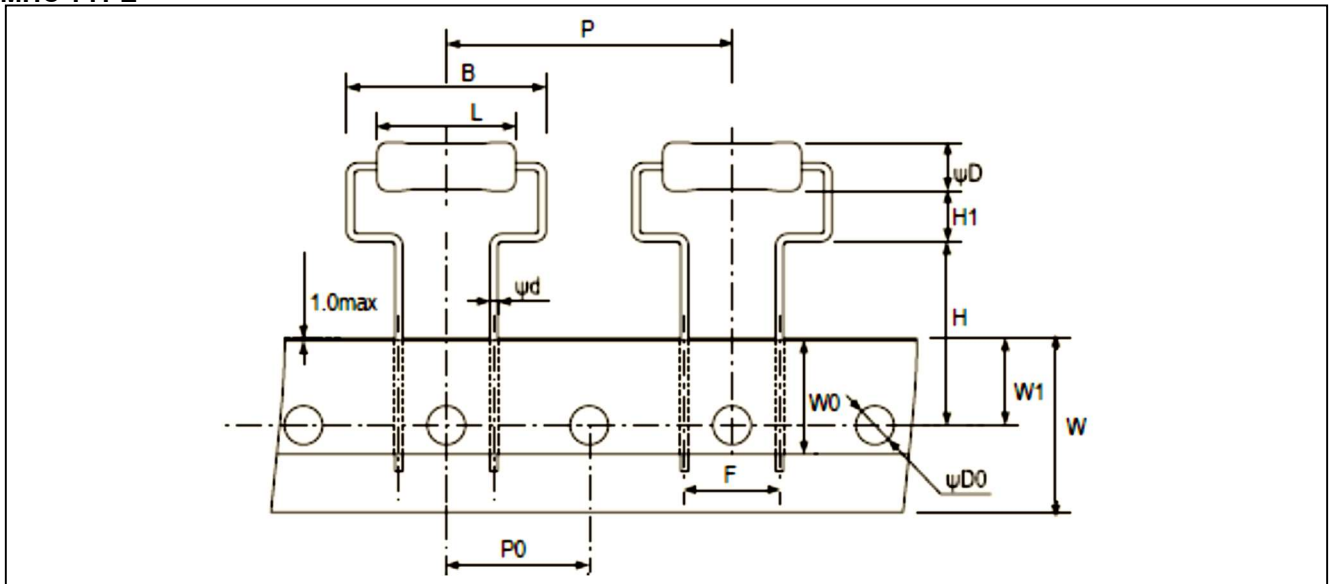

TYPE		DIMENSIONS								Unit: mm
Normal	Miniature	L	ψD	ψd	B	H	H1	P	P0	
		15.5±1.0	5.0±0.5	0.8±0.05	21.0Max.	19.0±1.0	5.25±1.0	30.0±1.0	15.0±0.3	
RSF200	RSF3WS	F	W	W0	W1	ψD0				
		10.0±0.5	18.0±0.5	5.0Min.	9.0±0.5	4.0±0.2				

F TYPE

FK TYPE

FFK TYPE

FKK TYPE

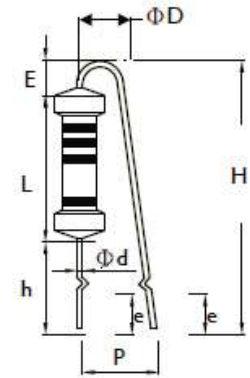
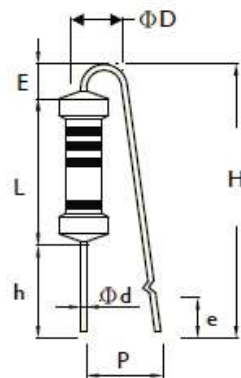
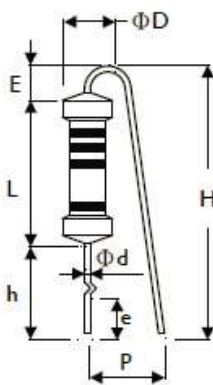
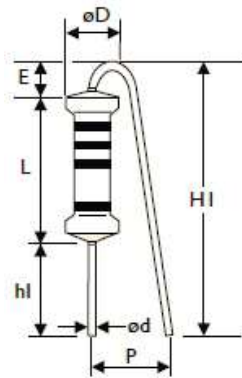

TYPE		DIMENSIONS										Unit: mm
Normal	Miniature	L	ψD	ψd	P	h	H Max.	h1	H1 Max.	E Max.	e	
RSF-50	RSF1WS	9.0±0.5	3.3±0.3	0.55±0.05	6±1	8±1	22	5±1	18.5	3.5	3.5±1	
RSF100	RSF2WS	11.5±1	4.5±0.5	0.8±0.05	6±1	8±1	24	5±1	20	3.5	3.5±1	
RSF200	RSF3WS	15.5±1	5.0±0.5	0.8±0.05	8±1	8±1	28	5±1	25	3.5	3.5±1	

PN TYPE (Taping Pack)

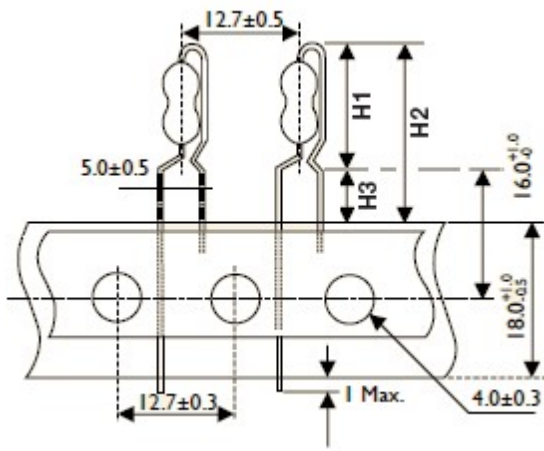

AV TYPE (Taping Pack)

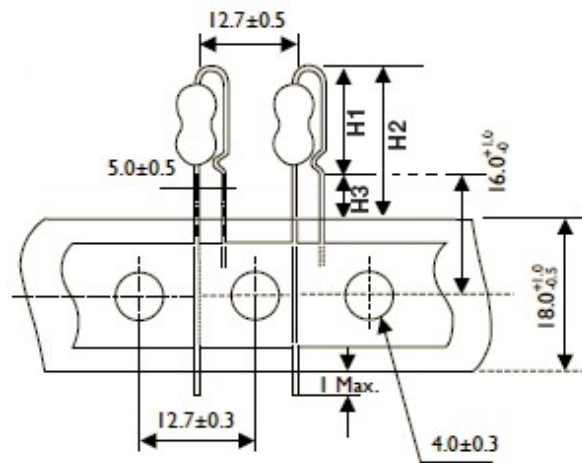

TYPE		DIMENSIONS			Unit: mm
Normal	Miniature	H1 Max.	H2 Max.	H3 Max.	
RSF-50	RSF1WS	17	25.5	8.5	
RSF100	RSF2WS	19	27.5	8.5	

TYPE		DIMENSIONS			Unit: mm
Normal	Miniature	H1 Max.	H2 Max.	H3 Max.	
RSF-50	RSF1WS	14.5	23	8.5	
RSF100	RSF2WS	17.5	26	8.5	

FT TYPE (Taping Pack)

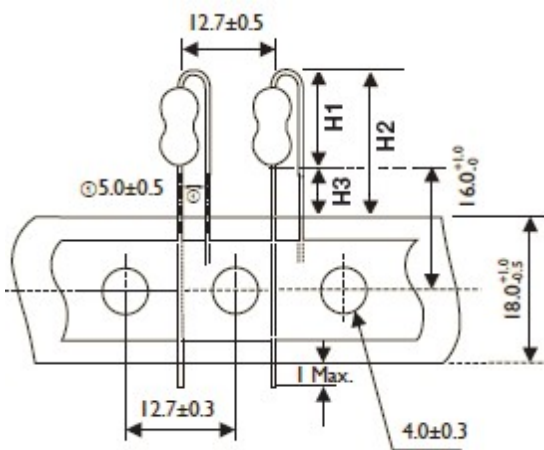

TYPE		DIMENSIONS			Unit: mm
Normal	Miniature	H1 Max.	H2 Max.	H3 Max.	
RSF-50	RSF1WS	13	21.5	8.5	
RSF100	RSF2WS	16	24.5	8.5	

MARKING



COLOR	1st BAND	2nd BAND	3rd BAND	MULTIPLIER	TOLERANCE
BLACK	0	0	0	1Ω	
BROWN	1	1	1	10Ω	
RED	2	2	2	100Ω	± 2% (G)
ORANGE	3	3	3	1KΩ	
YELLOW	4	4	4	10KΩ	
GREEN	5	5	5	100K	
BLUE	6	6	6	1MΩ	
VIOLET	7	7	7	10MΩ	
GREY	8	8	8	0.001Ω	
WHITE	9	9	9	0.0001Ω	
GOLD				0.1Ω	± 5% (J)
SILVER				0.01Ω	

REVISION HISTORY

REVISION	DATE	CHANGE NOTIFICATION	DESCRIPTION
Version 4	Apr.1, 2024	-	- Added forming code description for part number
Version 3	Mar.27, 2024	-	- Delete M type for RSF300&RSF5WS
Version 2	Nov.10, 2023	-	- Delete MB type for RSF300&RSF500&RSF5WS
Version 1	Aug.31, 2023	-	- Revised LEGAL DISCLAIMER
Version 0	Aug.16, 2021	-	- First issue of this specification

“ Yageo reserves all the rights for revising the content of this datasheet without further notification, as long as the products itse If are unchanged. Any product change will be announced by PCN.”

LEGAL DISCLAIMER

YAGEO, its distributors and agents (collectively, "YAGEO"), hereby disclaims any and all liabilities for any errors, inaccuracies or incompleteness contained in any product related information, including but not limited to product specifications, datasheets, pictures and/or graphics. YAGEO may make changes, modifications and/or improvements to product related information at any time and without notice.



YAGEO makes no representation, warranty, and/or guarantee about the fitness of its products for any particular purpose or the continuing production of any of its products. To the maximum extent permitted by law, YAGEO disclaims (i) any and all liability arising out of the application or use of any YAGEO product, (ii) any and all liability, including without limitation special, consequential or incidental damages, and (iii) any and all implied warranties, including warranties of fitness for a particular purpose, non-infringement and merchantability.

YAGEO products are designed for general purpose applications under normal operation and usage conditions. Please contact YAGEO for the applications listed below which require especially high reliability for the prevention of defects which might directly cause damage to the third party's life, body or property: Aerospace equipment (artificial satellite, rocket, etc.), Atomic energy-related equipment, Aviation equipment, Disaster prevention equipment, crime prevention equipment, Electric heating apparatus, burning equipment, Highly public information network equipment, data-processing equipment, Medical devices, Military equipment, Power generation control equipment, Safety equipment, Traffic signal equipment, Transportation equipment and Undersea equipment, or for any other application or use in which the failure of YAGEO products could result in personal injury or death, or serious property damage. Particularly **YAGEO Corporation and its affiliates do not recommend the use of commercial or automotive grade products for high reliability applications or manned space flight.**

Information provided here is intended to indicate product specifications only. YAGEO reserves all the rights for revising this content without further notification, as long as products are unchanged. Any product change will be announced by PCN.

Looking for pricing, stock, or lifecycle information?

Click below to explore more details on WIN SOURCE:

-  [View RSF200JB-73-2R7 on WIN SOURCE](#)
-  [Yageo Information](#)

Optimize Your Supply Chain with WIN SOURCE Solutions

-  Global Sourcing Solution
-  Obsolete Management
-  Cost Control Management
-  Shortage Management
-  Alternative Solution
-  Excess Inventory Management