



**THE DATASHEET OF  
FMP200JT-52-220K**



# DATA SHEET

## METAL FILM RESISTORS

High Power, Flameproof  
FMP Series

±1%, ±5%

1/2W to 3W

RoHS compliant & Halogen Free





**DIMENSIONS**

Unit: mm



Ultra Miniature	L	ψD	H	ψd
FMP-50	3.4 ± 0.3	1.9 ± 0.2	28 ± 2.0	0.45 ± 0.05
FMP100	6.3 ± 0.5	2.4 ± 0.2	28 ± 2.0	0.55 ± 0.05
FMP200	9.0 ± 0.5	3.9 ± 0.3	26 ± 2.0	0.55 ± 0.05
FMP3WS	11.5 ± 1.0	4.5 ± 0.5	35 ± 2.0	0.8 ± 0.05
FMP300	15.5 ± 1.0	5.0 ± 0.5	33 ± 2.0	0.8 ± 0.05

**DERATING CURVE**

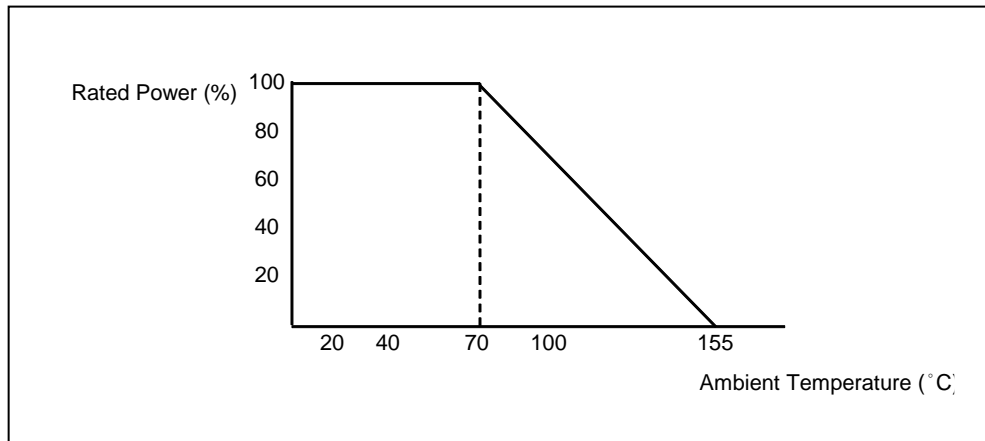

**ELECTRICAL CHARACTERISTICS**

CHARACTERISTICS	FMP-50	FMP100	FMP200	FMP3WS	FMP300
Power Rating at 70 °C	1/2W	1W	2W	3W	3W
Maximum Working Voltage	200V	350V	500V	500V	750V
Maximum Overload Voltage	400V	600V	700V	700V	1000V
Voltage Proof on Insulation	300V	500V	500V	500V	500V
Resistance Range	1Ω ~ 4M7Ω for E24 & E96 series value				
Operating Temp. Range	- 55°C to +155°C				
Temperature Coefficient	±100ppm/°C , ±50ppm/°C(FMP-50 & FMP100 types, R ≥ 10RΩ)				

Note: For resistance value out of above range is by request.

**TEST AND REQUIREMENTS**

TEST	TEST METHOD	PROCEDURE	APPRAISE
Short Time Overload	IEC 60115-1 4.13	2.5 times RCWV for 5 sec.(Not more than maximum overload voltage)	± 1.0 % + 0.05Ω
Voltage Proof on Insulation	IEC 60115-1 4.7	In V-Block for 60 sec. test voltage as above table	No Breakdown
Temperature Coefficient	IEC 60115-1 4.8	Between -55°C to +155°C	By Type
Insulation Resistance	IEC 60115-1 4.6	In V-Block for 60 sec.	>1,000MΩ
Solderability	IEC 60115-1 4.17	245±5°C for 3±0.5 Sec.	95% Min. coverage
Solvent Resistance of Marking	IEC 60115-1 4.30	IPA for 5±0.5 Min. with ultrasonic	No deterioration of coatings and markings
Robustness of Terminations	IEC 60115-1 4.16	Direct load for 10 Sec. in the direction of the terminal leads	≥2.5Kg(24.5N)
Periodic-pulse Overload	IEC 60115-1 4.39	4 times RCWV(or Umax., whichever less) 10,000 cycles (1 Sec. on, 25 Sec.off)	±1.0%+0.05Ω
Damp Heat Steady State	IEC 60115-1 4.24	40±2°C,90-95% RH for 56 days, loaded with 0.1 times RCWV(or Umax., whichever less)	±2.0%+0.05Ω
Endurance at 70°C	IEC 60115-1 4.25	70±2°C at RCWV(or Umax., whichever less) for 1,000 Hr.(1.5 Hr.on,0.5 Hr. off)	±2.0%+0.05Ω
Temperature Cycling	IEC 60115-1 4.19	-55°C → Room Temp. → +155°C → Room Temp.(5 cycles)	±1.0%+0.05Ω
Resistance to Soldering Heat	IEC 60115-1 4.18	260±3°C for 10±1 Sec., immersed to a point 3±0.5mm from the body	±0.25%+0.05Ω
Accidental Overload Test	IEC 60115-1 4.26	4 times RCWV(or Umax., whichever less) for 1 Min.	No evidence of flaming or arcing

Note:

**RCWV (Rated Continuous Working Voltage ):**

The DC or AC (rms) continuous working voltage corresponding to the rated power is determined by the following formula:

$$V=\sqrt{P \times R}$$

or max. working voltage whichever is less

Where

V=Continuous rated DC or  
AC (rms) working voltage (V)

P=Rated power (W)

R=Resistance value (Ω)

**PULSE DIAGRAMS**

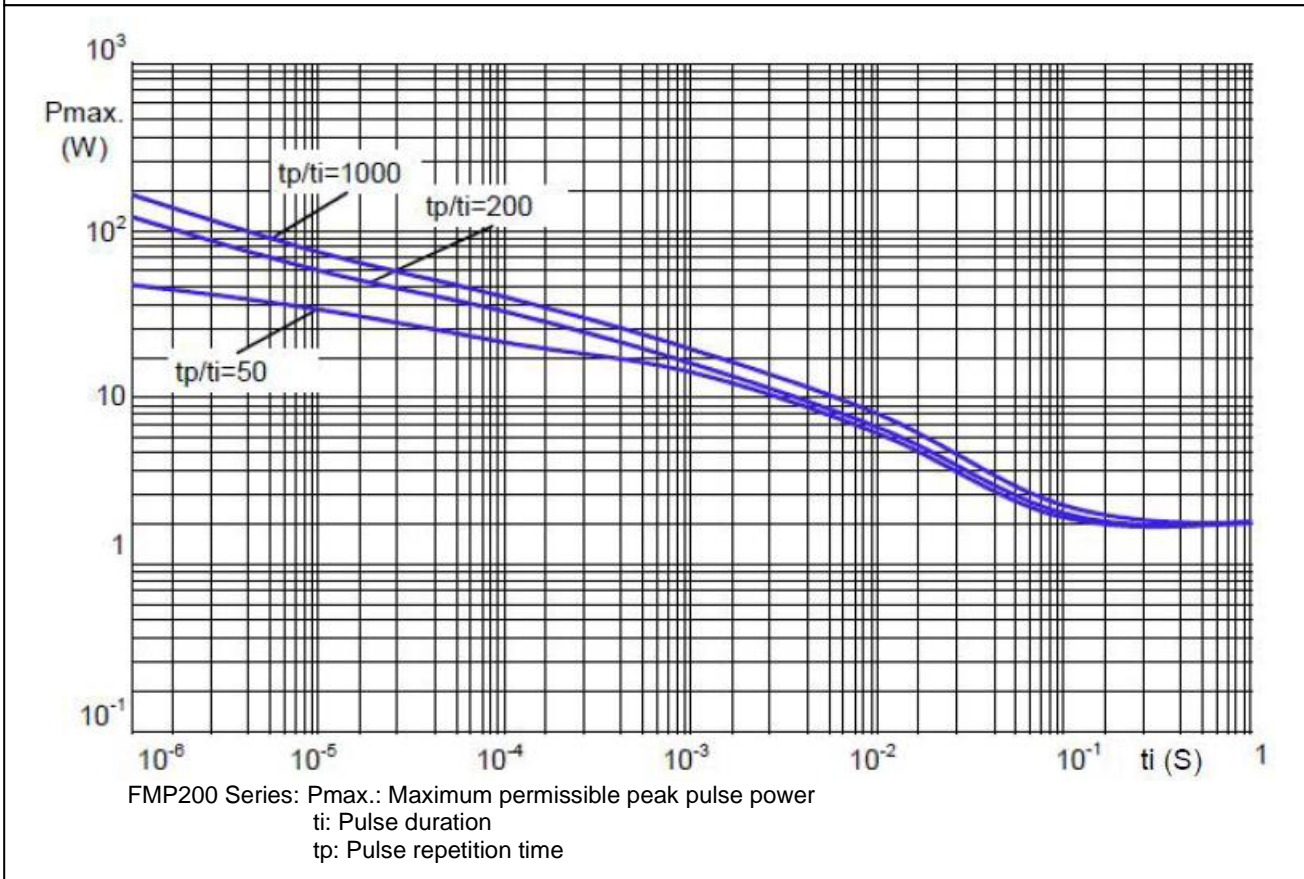
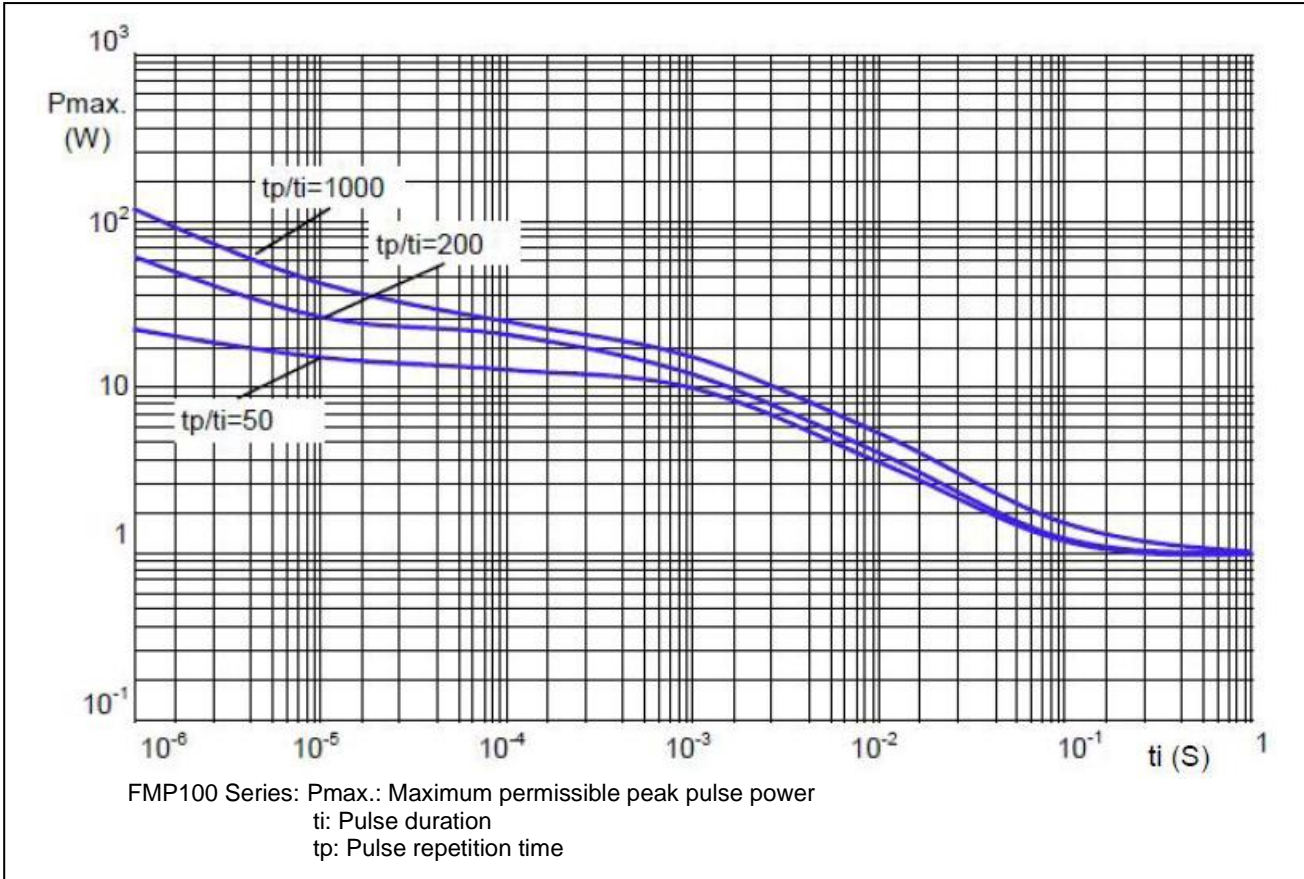

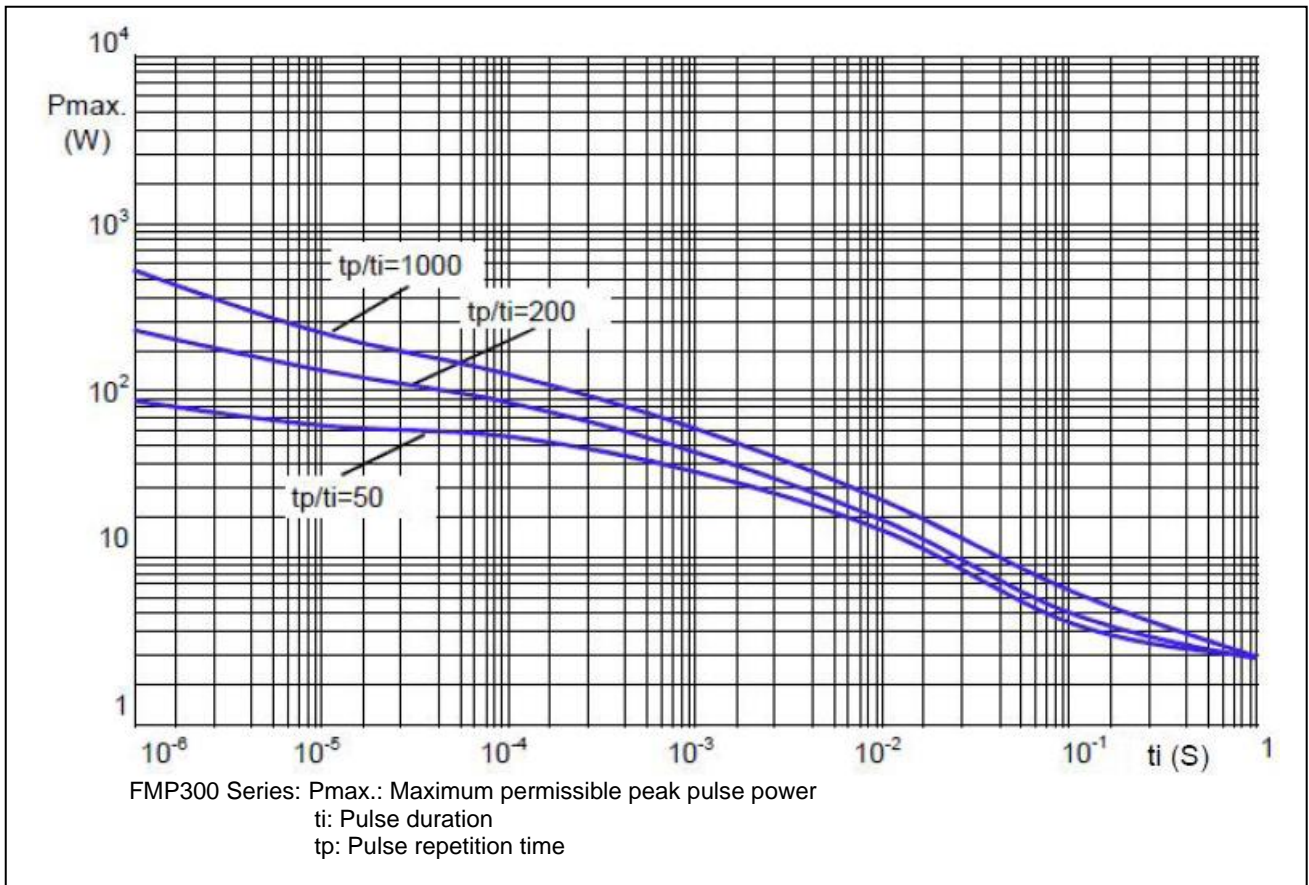

**AXIAL / REEL TAPE SPECIFICATION**

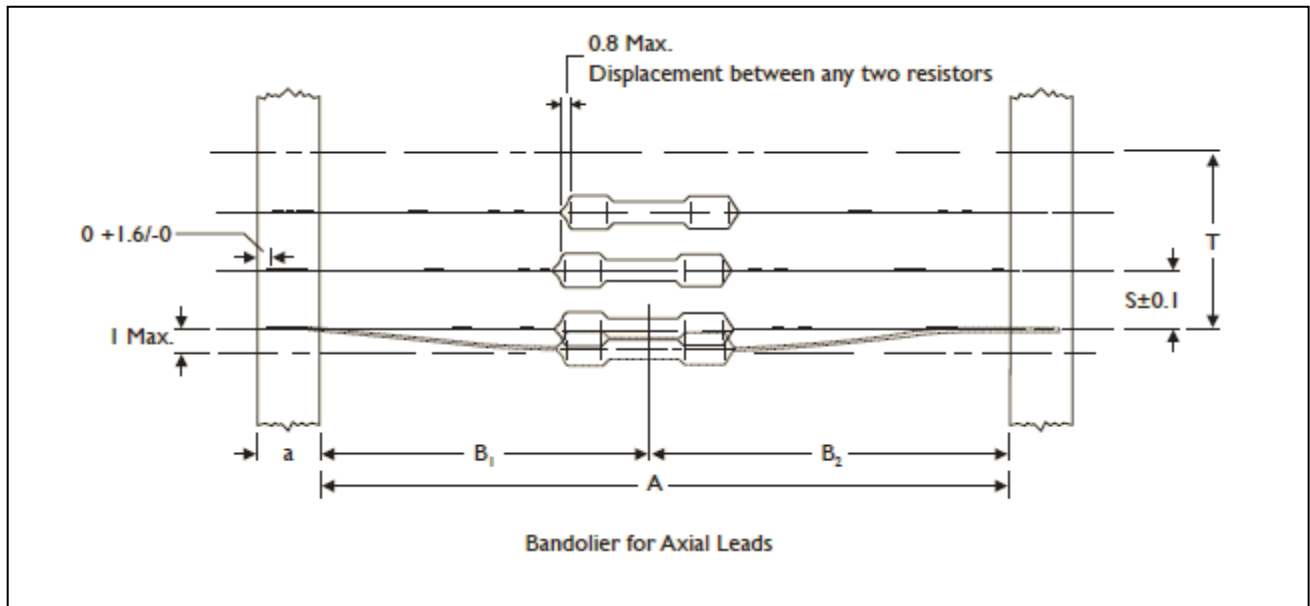

Unit: mm

Ultra Miniature	a	A	B1-B2 (Max.)	S (spacing)	T (max. deviation of spacing)
FMP-50	6 ± 0.5	52.4 ± 1.5 26.0 ± 1.5	1.2 1	5	
FMP100 FMP200	6 ± 0.5	52.4 ± 1.5	1.2	5	0.5 mm per 5 spacing 1 mm per 10 spacing
FMP3WS	6 ± 0.5	73.0 ± 1.5 52.4 ± 1.5	1.5 1.2	5	
FMP300	6 ± 0.5	73.0 ± 1.5	1.5	10	

**TAPE ON REEL PACKING**

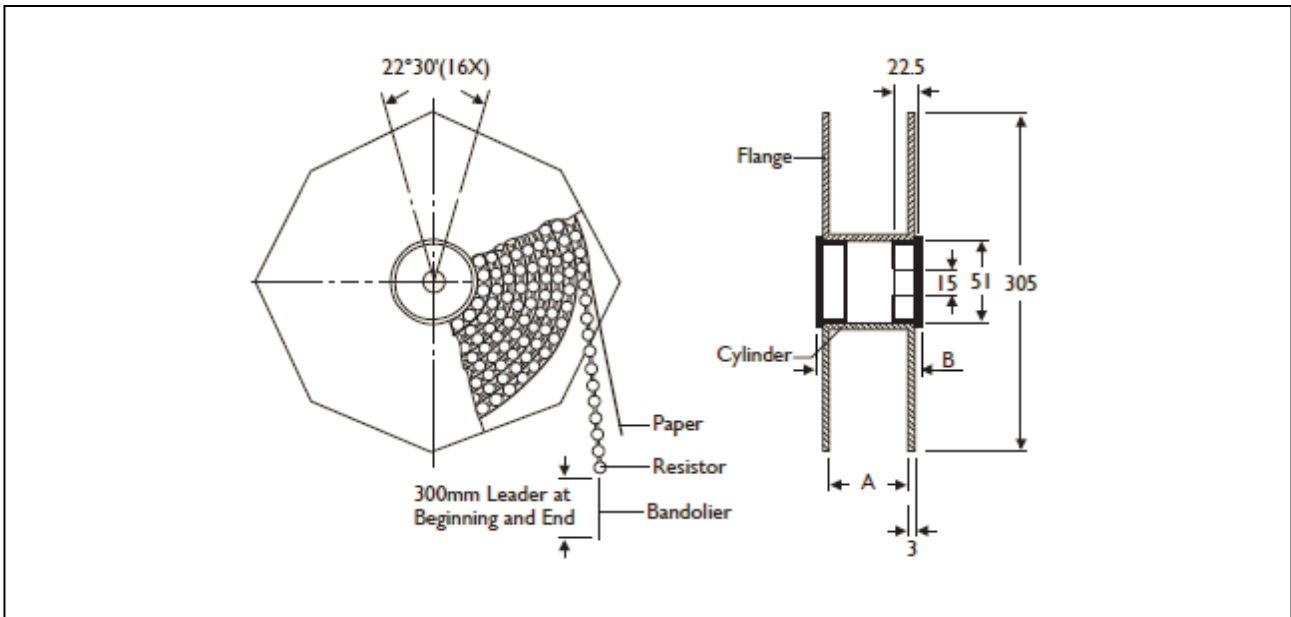

TYPE

Unit: mm/piece

Ultra Miniature	Across Flange(A)	B	Quantity Per Reel
FMP-50	66.5	75.5	5,000
FMP100	66.5	75.5	5,000
FMP200	66.5	75.5	2,500
FMP3WS	87	96	2,000
FMP300	87	96	1,000

**TAPE ON BOX PACKING**

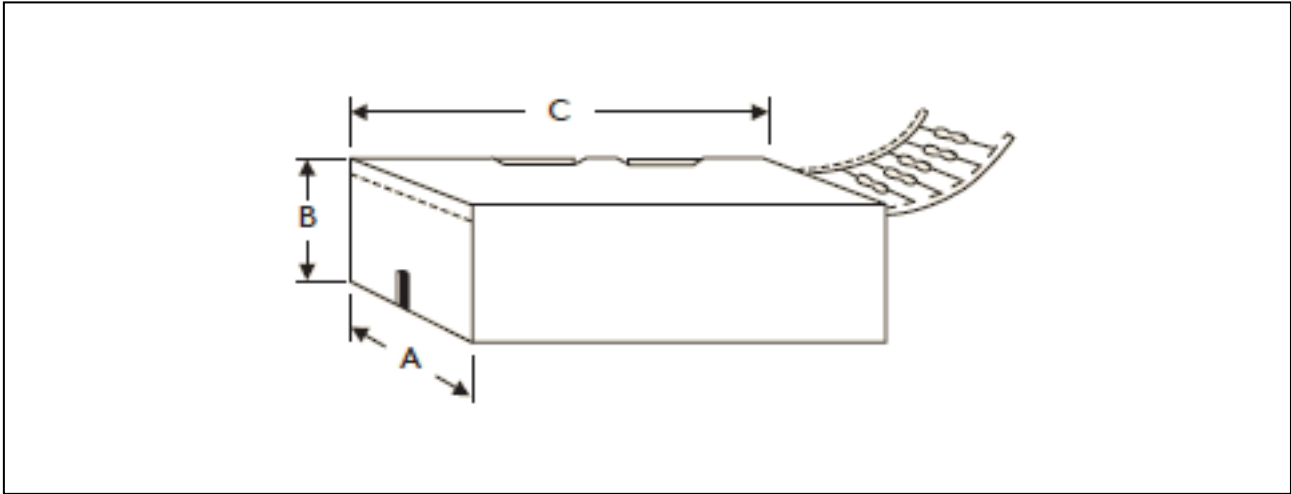

TYPE	DIMENSIONS			Quantity Per Box
	A	B	C	
FMP-50	81	70	260	5,000
FMP100	81	104	260	5,000
FMP200	73	45	258	1,000
FMP3WS	103	78	260	1,000
FMP300	103	78	260	1,000

**BULK PACKING**

Ultra Miniature	Piece/Per Inner Box	Bag/Per Inner Box	Piece Per Bag
FMP-50	10,000	10	1,000
FMP100	10,000	10	1,000
FMP200	5,000	5	1,000
FMP3WS	2,000	4	500
FMP300	1,000	2	500

**FORMING**

**M TYPE**

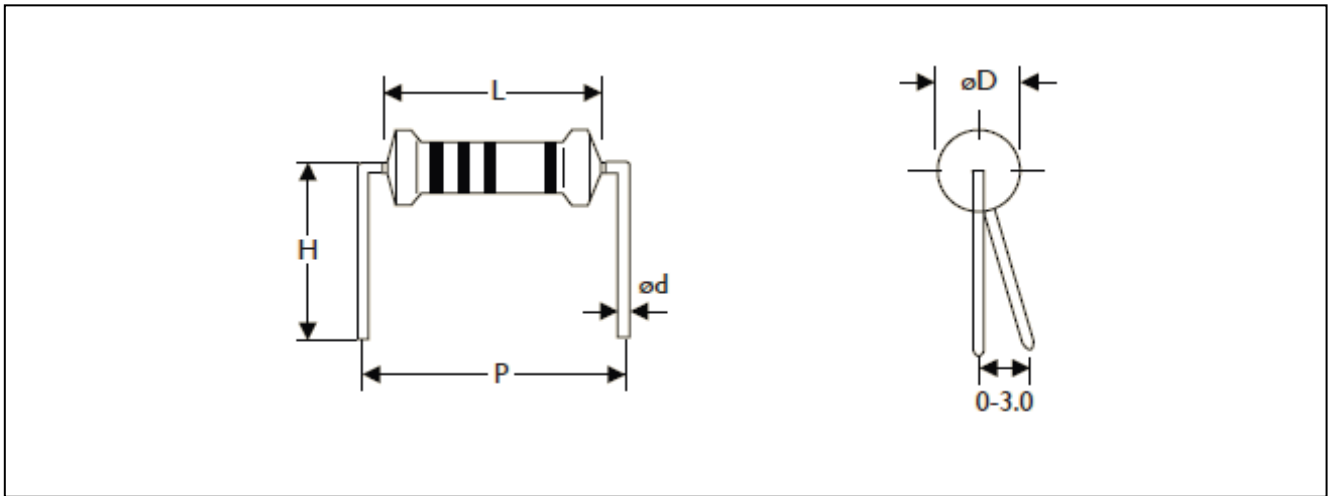

TYPE	DIMENSIONS					Unit: mm
	L	ψD	ψd	P	H	
Ultra Miniature						
FMP-50	3.4 ± 0.3	1.9 ± 0.2	0.45 ± 0.05	6.0 ± 1	10.0 ± 1	
FMP100	6.3 ± 0.5	2.4 ± 0.2	0.55 ± 0.05	10.0 ± 1	10.0 ± 1	
FMP300	15.5 ± 1.0	5.0 ± 0.5	0.8 ± 0.05	20.0 ± 1	15.0 ± 1	

**MHA TYPE**

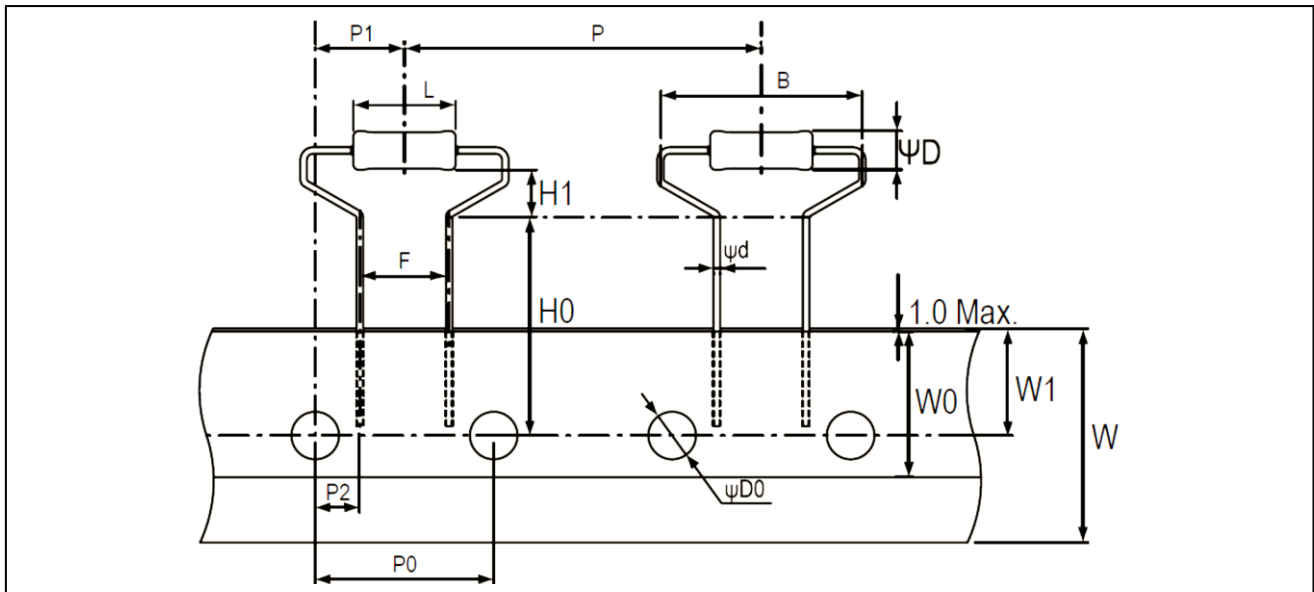

TYPE	DIMENSIONS								Unit: mm
Miniature	L	ψD	ψd	B	H0	H1	P	P0	
	9.0±0.5	3.9±0.3	0.55±0.05	17.5Max	19.0±1.0	4.0±1.0	30.0±1.0	15.0±0.3	
FMP200	P1	P2	F	W	W0	W1	ψD0		
	7.5±1.0	3.75±0.5	7.5±0.5	18.0±0.5	5.0Min	9.0±0.5	4.0±0.2		

**MHB TYPE**

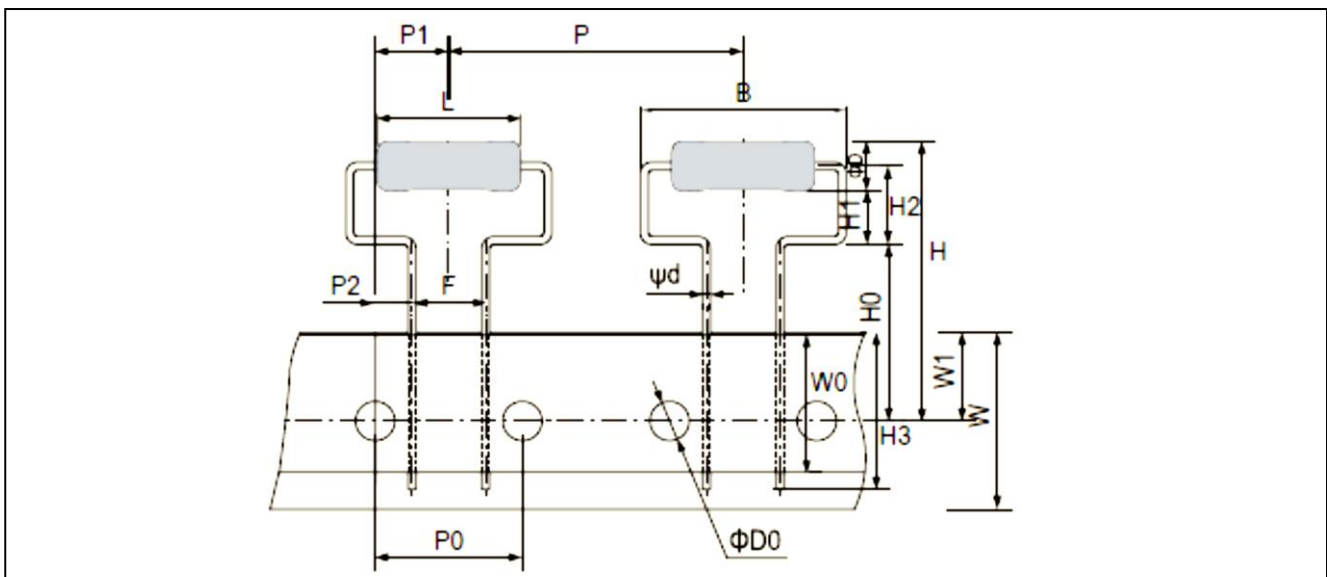

TYPE	DIMENSIONS										Unit: mm
Miniature	L	ψD	ψd	B	H	H0	H1	H2	H3		
	15.5±1.0	5.0±0.5	0.8±0.05	21.0Max.	30Max.	18.0±1.0	5.5(Ref.)	8.0±1.5	16Max.		
FMP300	P	P0	P1	P2	F	W	W0	W1	ψD0		
	30.0±1.0	15.0±0.3	7.5±1.0	3.75±0.8	7.5±0.5	18.0±0.5	5.0Min.	9.0±0.5	4.0±0.3		

**MHC TYPE**

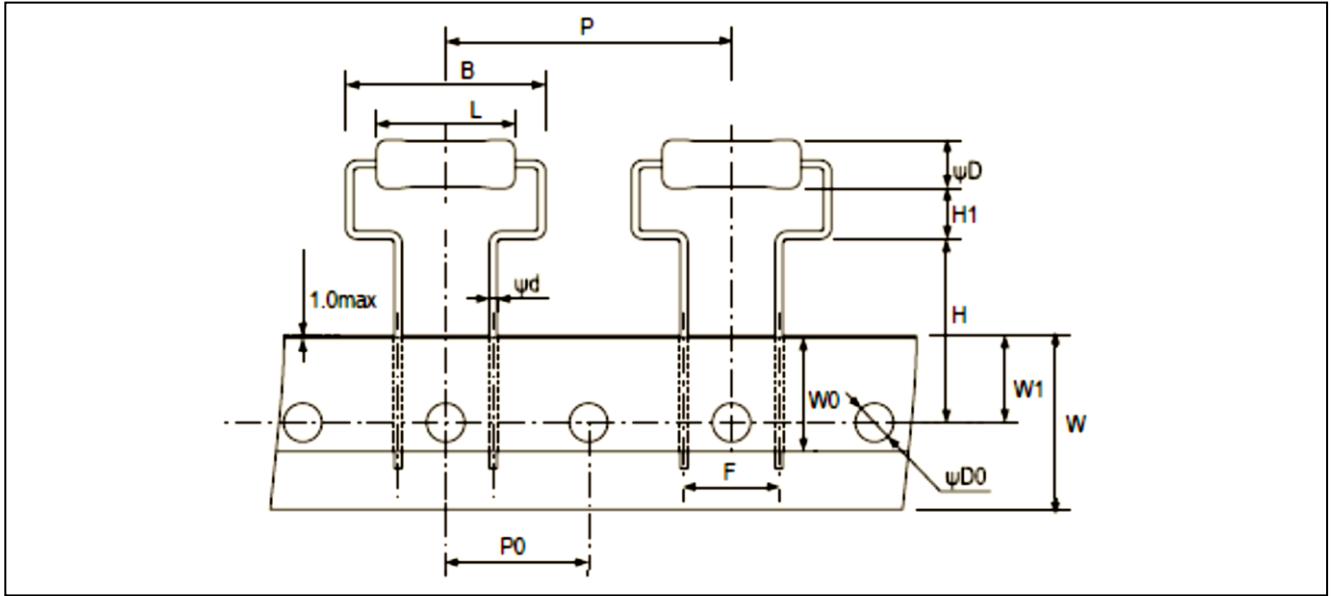

TYPE	DIMENSIONS					Unit: mm				
Miniature	L	ψD	ψd	B	H	H1	P	P0		
	15.5±1.0	5.0±0.5	0.8±0.05	21.0Max.	19.0±1.0	5.25±1.0	30.0±1.0	15.0±0.3		
FMP300	F	W	W0	W1	ψD0					
	10.0±0.5	18.0±0.5	5.0Min.	9.0±0.5	4.0±0.2					

**F TYPE**

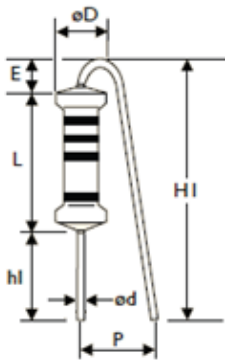

**FK TYPE**

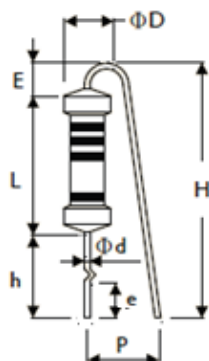

**FFK TYPE**

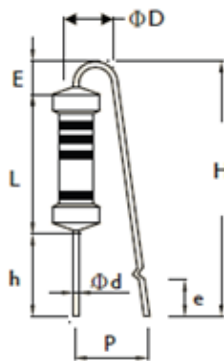

**FKK TYPE**

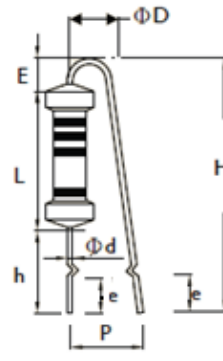

TYPE	DIMENSIONS										Unit: mm
Ultra Miniature	L	ψD	ψd	P	h	H Max.	h1	H1 Max.	E Max.	e	
	9.0±0.5	3.9±0.3	0.55±0.05	6±1	-	-	5±1	18.5	3.5	-	
FMP300	15.5±1	5.0±0.5	0.8±0.05	8±1	8±1	28	5±1	25	3.5	3.5±1	

**FT TYPE (Taping Pack)**

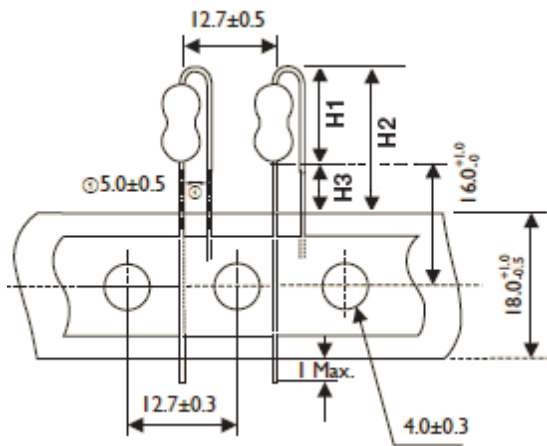

**MT TYPE (Taping Pack)**

Rated Watts : 0.5W

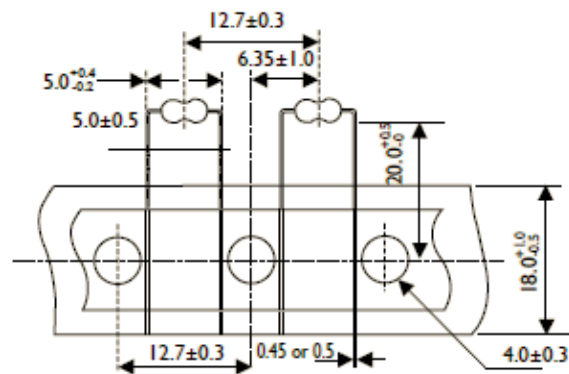

TYPE	DIMENSIONS			Unit: mm
Ultra Miniature	H1 Max.	H2 Max.	H3 Max.	
FMP100	10	18.5	8.5	
FMP200	13	21.5	8.5	
FMP3WS	16	24.5	8.5	

**PN TYPE (Taping Pack)**

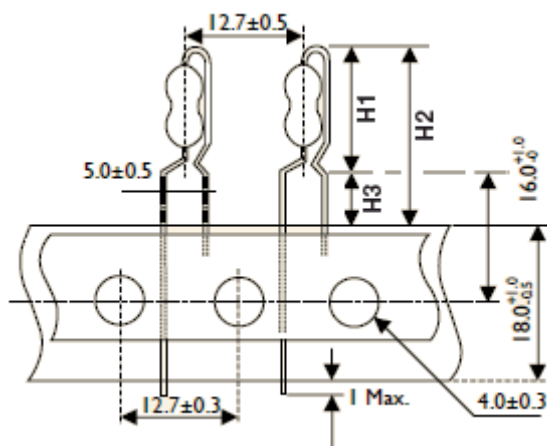

**AV TYPE (Taping Pack)**

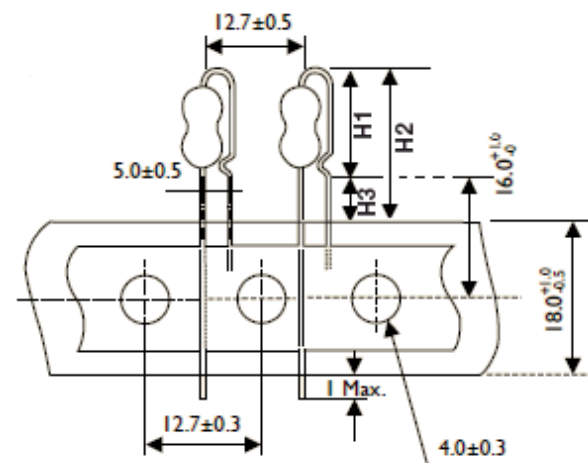

TYPE	DIMENSIONS			Unit: mm
Ultra Miniature	H1 Max.	H2 Max.	H3 Max.	
FMP100	13	21.5	8.5	
FMP200	17	25.5	8.5	
FMP3WS	19	27.5	8.5	

TYPE	DIMENSIONS			Unit: mm
Ultra Miniature	H1 Max.	H2 Max.	H3 Max.	
FMP100	11.5	20	8.5	
FMP200	14.5	23	8.5	
FMP3WS	17.5	26	8.5	

**MARKING**



COLOR	1st BAND	2nd BAND	3rd BAND	MULTIPLIER	TOLERANCE
BLACK	0	0	0	1Ω	
BROWN	1	1	1	10Ω	± 1% ( F )
RED	2	2	2	100Ω	
ORANGE	3	3	3	1KΩ	
YELLOW	4	4	4	10KΩ	
GREEN	5	5	5	100K	
BLUE	6	6	6	1MΩ	
VIOLET	7	7	7	10MΩ	
GREY	8	8	8	0.001Ω	
WHITE	9	9	9	0.0001Ω	
GOLD				0.1Ω	± 5 % ( J )
SILVER				0.01Ω	

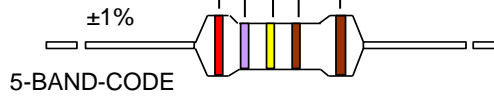

**REVISION HISTORY**

REVISION	DATE	CHANGE NOTIFICATION	DESCRIPTION
Version 6	May.14, 2024		- Added 52G type
Version 5	Apr.2, 2024		- Added forming code description for part number
Version 4	Aug.31, 2023		- Update legal disclaimer and footer version numbers
Version 3	May.25, 2023		- Updated the tape specification of FMP300
Version 2	Oct.25, 2021		- Add F type for FMP200 series
Version 1	Oct.12, 2021	-	- Updated the tape specification of FMP200
Version 0	Aug.2, 2021	-	- First issue of this specification

*“ Yageo reserves all the rights for revising the content of this datasheet without further notification, as long as the products itse If are unchanged. Any product change will be announced by PCN.”*

## LEGAL DISCLAIMER

YAGEO, its distributors and agents (collectively, "YAGEO"), hereby disclaims any and all liabilities for any errors, inaccuracies or incompleteness contained in any product related information, including but not limited to product specifications, datasheets, pictures and/or graphics. YAGEO may make changes, modifications and/or improvements to product related information at any time and without notice.



YAGEO makes no representation, warranty, and/or guarantee about the fitness of its products for any particular purpose or the continuing production of any of its products. To the maximum extent permitted by law, YAGEO disclaims (i) any and all liability arising out of the application or use of any YAGEO product, (ii) any and all liability, including without limitation special, consequential or incidental damages, and (iii) any and all implied warranties, including warranties of fitness for a particular purpose, non-infringement and merchantability.

YAGEO products are designed for general purpose applications under normal operation and usage conditions. Please contact YAGEO for the applications listed below which require especially high reliability for the prevention of defects which might directly cause damage to the third party's life, body or property: Aerospace equipment (artificial satellite, rocket, etc.), Atomic energy-related equipment, Aviation equipment, Disaster prevention equipment, crime prevention equipment, Electric heating apparatus, burning equipment, Highly public information network equipment, data-processing equipment, Medical devices, Military equipment, Power generation control equipment, Safety equipment, Traffic signal equipment, Transportation equipment and Undersea equipment, or for any other application or use in which the failure of YAGEO products could result in personal injury or death, or serious property damage. Particularly **YAGEO Corporation and its affiliates do not recommend the use of commercial or automotive grade products for high reliability applications or manned space flight.**





Information provided here is intended to indicate product specifications only. YAGEO reserves all the rights for revising this content without further notification, as long as products are unchanged. Any product change will be announced by PCN.

## Looking for pricing, stock, or lifecycle information?

Click below to explore more details on WIN SOURCE:

-  [View FMP200JT-52-220K on WIN SOURCE](#)
-  [Yageo Information](#)

## Optimize Your Supply Chain with WIN SOURCE Solutions

-  Global Sourcing Solution
-  Obsolete Management
-  Cost Control Management
-  Shortage Management
-  Alternative Solution
-  Excess Inventory Management