



THE DATASHEET OF ROX1SJ180R



Key Features

High Power with Small Size for Space Saving

Excellent Long Term Stability

Complete Flameproof Construction

Controlled Temperature Capability

Solvent Resistant Coat and Code

Special Lead Formations Possible

Type ROX Series

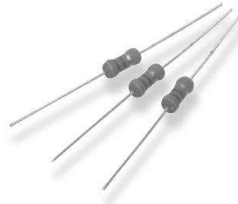

The resistive element comprises a metal oxide film deposited on a ceramic former. The element is protected by a flameproof coating which will withstand overload conditions without flame or mechanical damage. They are recommended for use in applications such as line protection etc

Characteristics – Electrical

| Type | Rated Power @ 70°C | Max. Working Voltage | Max. Overload Voltage | Dielectric Withstand Voltage | Resistance Range Ω | Operating Temp. Range | |
|-------------|--------------------|----------------------|-----------------------|------------------------------|--------------------|-----------------------|-----------|
| Normal Size | ROX025 | 0.25W | 250V | 400V | 250V | 0.3 ~ 50K | -55~130°C |
| | ROX05 | 0.5W | 250V | 400V | 250V | 0.3 ~ 50K | |
| | ROX1 | 1W | 350V | 600V | 350V | 0.1 ~ 50K | |
| | ROX2 | 2W | 350V | 600V | 350V | 0.1 ~ 50K | -55~200°C |
| | ROX3 | 3W | 500V | 800V | 500V | 5.0 ~ 100K | |
| | ROX5 | 5W | 750V | 1000V | 750V | 5.0 ~ 150K | |
| | ROX7 | 7W | 750V | 1000V | 750V | 20 ~ 150K | |
| | ROX8 | 8W | 750V | 1000V | 750V | 30 ~ 200K | |
| | ROX9 | 9W | 750V | 1000V | 750V | 50 ~ 200K | |
| Small Size | ROX05S | 0.5W | 250V | 400V | 250V | 0.3 ~ 50K | -55~130°C |
| | ROX1S | 1W | 350V | 600V | 350V | 0.3 ~ 1M0 | |
| | ROX2S | 2W | 350V | 600V | 350V | 0.3 ~ 1M0 | |
| | ROX3S | 3W | 350V | 600V | 350V | 0.3 ~ 1M0 | -55~200°C |
| | ROX4S | 4W | 500V | 800V | 500V | 5.0 ~ 100K | |
| | ROX5SS | 5W | 500V | 800V | 500V | 5.0 ~ 100K | |
| | ROX5S | 5W | 500V | 800V | 500V | 5.0 ~ 150K | |

Resistors shall have a rated direct-current (DC) continuous working voltage or an approximate sine-wave root-mean-square (RMS) alternating-current (AC) continuous working voltage at commercial line frequency and waveform corresponding to the power rating , as determined from the following formula :

$$RCWV = \sqrt{P \times R}$$

Where : RCWV = Rated DC or RMS AC continuous working voltage at commercial-line frequency and waveform (volt)

P = Power Rating (watt)

R = Nominal Resistance (ohm)

Rated Voltage = RCWV or Max. Working Voltage, whichever is smaller

Environmental Characteristics

| Characteristics | Specification | Test Methods (JIS C 5201-1) | |
|---------------------------------|-----------------------------------------------------------------------------------------------------------------------------------------------------------------|-----------------------------------------------------------------------------------------------------------------------------------------------------------------------------------------------------------------------------------------------------------------------------------------------------------------------------------------------------------------------------------------------------------|-----------|
| DC. Resistance | Must be within the specified tolerance | 5.1 The limit of error of measuring apparatus shall not exceed allowable range or 5% of resistance tolerance | |
| Temperature Coefficient | Range Ω | 5.2 Natural resistance change per temp. degree centigrade. $\frac{R_2 - R_1}{R_1(t_2 - t_1)} \times 10^6 \text{ (PPM/}^\circ\text{C)}$ R ₁ : Resistance value at room temperature (t ₁) R ₂ : Resistance value at room temp. plus 100 °C (t ₂) | |
| | 0.1 Ω ~ 12 Ω | | ± 200 |
| | 12.1 Ω ~ 100K | | ± 350 |
| | 101K ~ 1M | | -700 |
| | 1.1M ~ 10M | | -1500 |
| Short time overload | Resistance change rate is Normal Size : $\pm (1\% + 0.05\Omega)$ Max. Small Size : $\pm (2\% + 0.05\Omega)$ Max. with no evidence of mechanical damage | 5.5 Permanent resistance change after the application of a potential of 2.5 times RCWV or the max. overload voltage respectively specified in the above list, whichever less for 5 seconds | |
| Dielectric Withstanding Voltage | No evidence of flashover mechanical damage, arcing or insulation break down | 5.7 Resistors shall be clamped in the trough of a 90° metallic V-block and shall be tested at AC potential respectively specified in the electrical characteristics table for 60 + 10/ -0 seconds | |
| Terminal Strength | No Evidence of mechanical damage | 6.1 Direct load: Resistance to a 2.5 kgs direct load for 10 secs. in the direction of the longitudinal axis of the terminal leads Twist test: Terminal leads shall be bent through 90° at point of about 6mm from the body of the resistor and shall be rotated through 360° about the original axis of the bent terminal in alternating direction for a total of 3 rotations. | |
| Resistance to soldering heat | Resistance change rate is: $\pm (1\% + 0.05\Omega)$ Max. with no evidence of mechanical damage | 6.4 Permanent resistance change when leads immersed to 3.2 mm to 4.8 mm from the body in 350°C \pm 10 °C solder for 3 \pm 0.5 seconds | |
| Solderability | 95 % coverage Min. | 6.5 The area covered with a new , smooth, clean , shiny and continuous surface free from concentrated pinholes. Test temp. of solder: 245°C \pm 3°C Dwell time in solder : 2 ~ 3 seconds | |

Environmental Characteristics (continued)

| Characteristics | Specification | Test Methods (JIS C 5201-1) | | | | | | | | | | | | | | | |
|-----------------------|------------------------------------------------------------------------------------------------------------------------------------------------------------------------------------------------------------------------------------------------------------------------------------------------------------|-------------------------------------------------------------------------------------------------------------------------------------------------------------------------------------------------------------------------------------------------------------------------------------------------------------------------------------------------------------------------------------------------------------------------------------|--------------------------|-------------------------|-----------|-----------------------|--------------------------|------------------------------------------------------------------------------------------------------------------------------------------------------------------------------------------------------------------------------|---|-----------|------------|---|--------------------------|---------|---|-----------|------------|
| Resistance to Solvent | No deterioration of protective coatings and marking | 6.9 Specimens shall be immersed in a bath of trichroethane completely for 3 minutes with ultrasonic | | | | | | | | | | | | | | | |
| Temperature cycling | Resistance change rate is: $\pm (2\% + 0.05\Omega)$ Max. with no evidence of mechanical damage | 7.4 Resistance change after continuous 5 cycles for duty shown below: | | | | | | | | | | | | | | | |
| | | <table border="1"> <thead> <tr> <th>Step</th> <th>Temp.</th> <th>Time</th> </tr> </thead> <tbody> <tr> <td>1</td> <td>-55\pm3$^{\circ}$C</td> <td>30 mins</td> </tr> <tr> <td>2</td> <td>Room Temp</td> <td>10~15 mins</td> </tr> <tr> <td>3</td> <td>155\pm2$^{\circ}$C</td> <td>30 mins</td> </tr> <tr> <td>4</td> <td>Room Temp</td> <td>10~15 mins</td> </tr> </tbody> </table> | Step | Temp. | Time | 1 | -55 \pm 3 $^{\circ}$ C | 30 mins | 2 | Room Temp | 10~15 mins | 3 | 155 \pm 2 $^{\circ}$ C | 30 mins | 4 | Room Temp | 10~15 mins |
| | | Step | Temp. | Time | | | | | | | | | | | | | |
| | | 1 | -55 \pm 3 $^{\circ}$ C | 30 mins | | | | | | | | | | | | | |
| | | 2 | Room Temp | 10~15 mins | | | | | | | | | | | | | |
| 3 | 155 \pm 2 $^{\circ}$ C | 30 mins | | | | | | | | | | | | | | | |
| 4 | Room Temp | 10~15 mins | | | | | | | | | | | | | | | |
| | | | | | | | | | | | | | | | | | |
| | | | | | | | | | | | | | | | | | |
| | | | | | | | | | | | | | | | | | |
| Load life in humidity | <table border="1"> <thead> <tr> <th>Resistance Value</th> <th>$\Delta R/R$</th> </tr> </thead> <tbody> <tr> <td>Less than 100KΩ</td> <td>$\pm 5\%$</td> </tr> <tr> <td>100KΩ or more</td> <td>$\pm 10\%$</td> </tr> </tbody> </table> | Resistance Value | $\Delta R/R$ | Less than 100K Ω | $\pm 5\%$ | 100K Ω or more | $\pm 10\%$ | 7.9 Resistance change after 1,000 hours operating at RCWV with duty cycle of (1.5 hours "on", 0.5 hour "off") in a humidity test chamber controlled at 40 $^{\circ}$ C \pm 2 $^{\circ}$ C and 90 to 95 % relative humidity | | | | | | | | | |
| | Resistance Value | $\Delta R/R$ | | | | | | | | | | | | | | | |
| | Less than 100K Ω | $\pm 5\%$ | | | | | | | | | | | | | | | |
| 100K Ω or more | $\pm 10\%$ | | | | | | | | | | | | | | | | |
| | | | | | | | | | | | | | | | | | |
| | | | | | | | | | | | | | | | | | |
| Load life | <table border="1"> <thead> <tr> <th>Resistance Value</th> <th>$\Delta R/R$</th> </tr> </thead> <tbody> <tr> <td>Less than 100KΩ</td> <td>$\pm 5\%$</td> </tr> <tr> <td>100KΩ or more</td> <td>$\pm 10\%$</td> </tr> </tbody> </table> | Resistance Value | $\Delta R/R$ | Less than 100K Ω | $\pm 5\%$ | 100K Ω or more | $\pm 10\%$ | 7.10 Permanent resistance change after 1,000 hours operating at RCWV with duty cycle of (1.5 hours "on", 0.5 hour "off") at 70 $^{\circ}$ C \pm 2 $^{\circ}$ C ambient | | | | | | | | | |
| | Resistance Value | $\Delta R/R$ | | | | | | | | | | | | | | | |
| | Less than 100K Ω | $\pm 5\%$ | | | | | | | | | | | | | | | |
| 100K Ω or more | $\pm 10\%$ | | | | | | | | | | | | | | | | |
| | | | | | | | | | | | | | | | | | |
| | | | | | | | | | | | | | | | | | |
| Pulse overload | Resistance change rate is: Normal Size : $\pm (2\% + 0.05\Omega)$ Max. Small Size : $\pm (5\% + 0.05\Omega)$ Max. with no evidence of mechanical damage | 5.8 Resistance change after 10,000 cycles (1 second "on", 25 seconds "off") at 4 times RCWV or the max. pulse overload voltage | | | | | | | | | | | | | | | |

Derating:

In ambient temperatures greater than 70 $^{\circ}$ C the load shall de-rate as shown in the graph below:

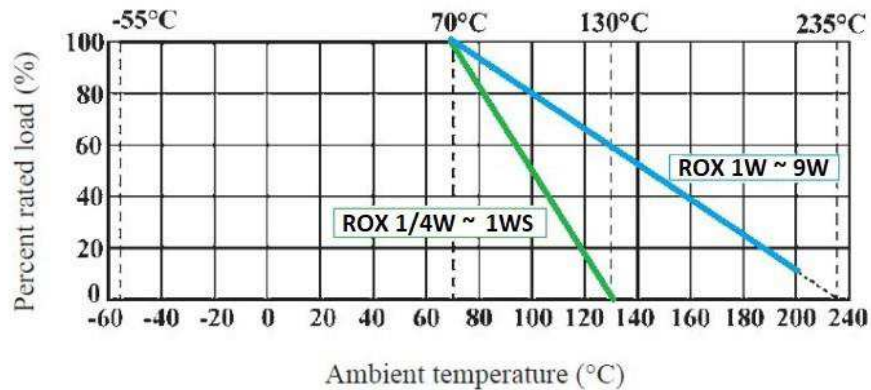

Construction:

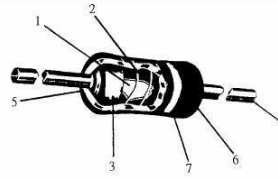

| No. | Name | Material |
|-----|-----------------|---------------------------------------------------------------------------------------------------------------------------|
| 1 | Basic Body | Rod Type Ceramics |
| 2 | Resistance Film | 0.1Ω ≤ R ≤ 12Ω : CNP film For All Wattage |
| | | 12.1Ω ≤ R ≤ 100KΩ : Metal oxide film For 1/2W-S, 1/4W |
| | | R > 100KΩ : Carbon film For 1/2W, 1W-S |
| | | 12.1Ω ≤ R ≤ 120KΩ : Metal oxide film For 1W, 2W-S, 2W, 3W-S, 3W, 4W-S, 5W-SS |
| | | R > 120KΩ : Carbon film (For 5W, 5W-S) |
| | | 12.1Ω ≤ R ≤ 150KΩ : Metal oxide film For 7W, 8W, 9W |
| | | R > 150KΩ : Carbon film |
| | | 12.1Ω ≤ R ≤ 180KΩ : Metal oxide film (For 5W, 5W-S) |
| 6 | Coating | Normal size --Insulated & Non-Flame Paint (Color : Gray) Small size --Insulated & Non-Flame Paint (Color : Sea-Blue) |
| 7 | Color Code | Non-Flame epoxy resin |
| 3 | End Cap | Steel (Tin plated iron surface) |
| 4 | Lead Wire | Annealed copper wire coated with tin |
| 5 | Joint | By welding |

Dimensions:

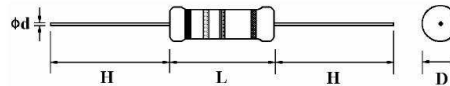

| Type | Dimensions (MM) | | | | |
|-------------|-----------------|----------|---------|------|----|
| | D (max.) | L (max.) | d ±0.05 | H ±3 | |
| Normal Size | ROX025 | 2.5 | 7.5 | 0.54 | 28 |
| | ROX05 | 3.5 | 10 | 0.70 | 28 |
| | ROX1 | 5 | 12 | 0.70 | 25 |
| | ROX2 | 5.5 | 16 | 0.70 | 28 |
| | ROX3 | 6.5 | 17.5 | 0.75 | 28 |
| | ROX5 | 8.5 | 26 | 0.75 | 38 |
| | ROX7 | 8.5 | 32 | 0.75 | 38 |
| | ROX8 | 8.5 | 41 | 0.75 | 38 |
| | ROX9 | 8.5 | 54 | 0.75 | 38 |
| Small Size | ROX05S | 2.5 | 7.5 | 0.54 | 28 |
| | ROX1S | 3.5 | 10 | 0.70 | 28 |
| | ROX2S | 5 | 12 | 0.70 | 25 |
| | ROX3S | 5.5 | 16 | 0.70 | 28 |
| | ROX4S | 6.5 | 17.5 | 0.75 | 28 |
| | ROX5SS | 6.5 | 17.5 | 0.75 | 28 |
| | ROX5S | 8 | 25 | 0.75 | 38 |

Painting method:

Welding point, terminal and lead wire, is permissible to be exposed without the outer coated cover. The extent should be within 1/2 of the resistor body diameter.

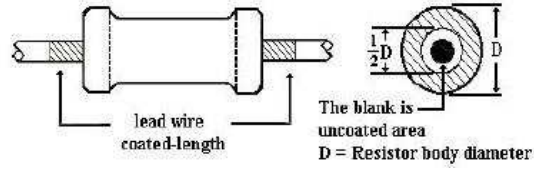

Marking:

For 1/4W, 1/2W, 1W, 2W, 3W, 4W, 5W and all of small size Resistors shall be marked with color coding. colors shall be in accordance with JIS C 0802

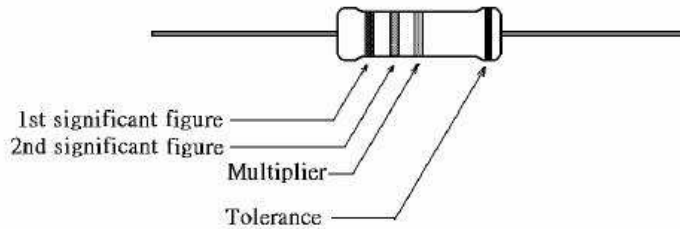

For 7W, 8W, 9W marking shall be in text format:

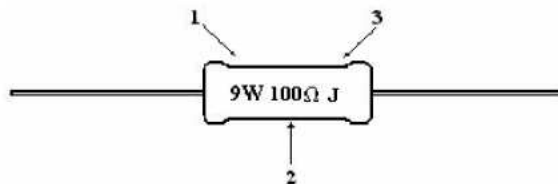

Code description and regulation

1. Wattage rating.
2. Nominal resistance value.
3. Resistance Tolerance.

G: ± 2 %

J: ± 5 %

K: ± 10 %

Packing Specification:

Taping:

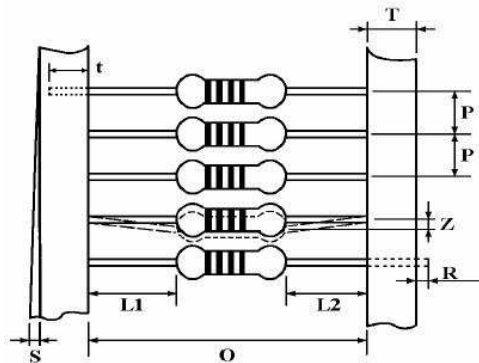

| | Type | Style | O±1 | P | L1-L2 | T | Z | R | t | S |
|-------------|--------|-------|-----|--------|-------|-----|-------|---|-----|---------|
| Normal Size | ROX025 | PT-52 | 52 | 5±0.3 | 1 Max | 6±1 | 1 Max | 0 | 4±1 | 0.5 max |
| | ROX05 | PT-52 | 52 | 5±0.3 | 1 Max | 6±1 | 1 Max | 0 | 4±1 | 0.5 max |
| | ROX1 | PT-52 | 52 | 5±0.3 | 1 Max | 6±1 | 1 Max | 0 | 4±1 | 0.5 max |
| | ROX2 | PT-64 | 64 | 10±0.5 | 1 Max | 6±1 | 1 Max | 0 | 5±1 | 0.5 max |
| | ROX3 | PT-64 | 64 | 10±0.5 | 1 Max | 6±1 | 1 Max | 0 | 5±1 | 0.5 max |
| Small Size | ROX05S | PT-52 | 52 | 5±0.3 | 1 Max | 6±1 | 1 Max | 0 | 4±1 | 0.5 max |
| | ROX1S | PT-52 | 52 | 5±0.3 | 1 Max | 6±1 | 1 Max | 0 | 4±1 | 0.5 max |
| | ROX2S | PT-52 | 52 | 5±0.3 | 1 Max | 6±1 | 1 Max | 0 | 4±1 | 0.5 max |
| | ROX3S | PT-64 | 64 | 10±0.5 | 1 Max | 6±1 | 1 Max | 0 | 5±1 | 0.5 max |
| | ROX4S | PT-64 | 64 | 10±0.5 | 1 Max | 6±1 | 1 Max | 0 | 5±1 | 0.5 max |
| | ROX5SS | PT-64 | 64 | 10±0.5 | 1 Max | 6±1 | 1 Max | 0 | 5±1 | 0.5 max |

Tape in box packing (Ammopack):

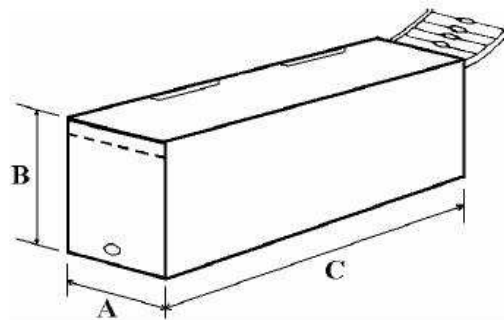

| Type | C ± 5 | A ± 5 | B ± 5 | Pack Quantity |
|--------|-------|-------|-------|---------------|
| ROX025 | 250 | 75 | 96 | 5000 |
| ROX05 | 260 | 85 | 70 | 1000 |
| ROX1 | 262 | 86 | 80 | 1000 |
| ROX2 | 262 | 92 | 108 | 1000 |
| ROX3 | 256 | 92 | 80 | 500 |
| ROX05S | 250 | 75 | 96 | 5000 |
| ROX1S | 260 | 85 | 70 | 1000 |
| ROX2S | 262 | 86 | 80 | 1000 |
| ROX3S | 262 | 92 | 108 | 1000 |
| ROX4S | 256 | 92 | 80 | 500 |
| ROX5SS | 256 | 92 | 80 | 500 |

NB Certain products can be supplied reeled on request.

Plastic cases in box:

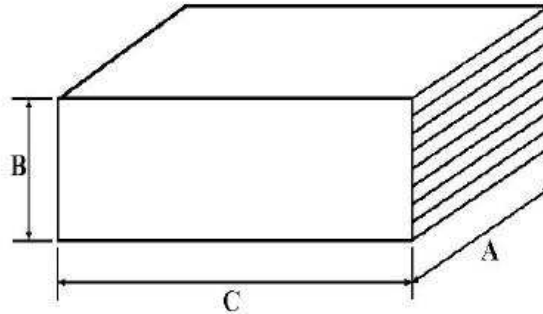

| Type | C ±5 | A ±5 | B ±5 | Quantity | |
|-------|------|------|------|--------------|------|
| | | | | Plastic Case | Box |
| ROX5S | 36 | 20 | 8 | 100 | 1000 |
| ROX5 | 36 | 20 | 8 | 100 | 1000 |

Bulk packaging (plastic bag in inner box):

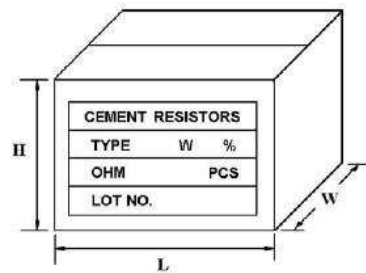

Inner Box of Plastic bag.

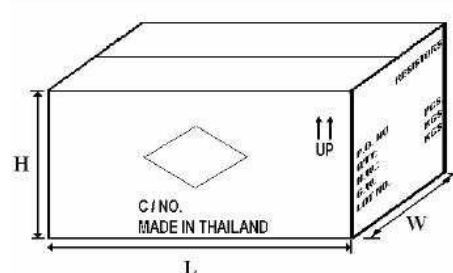

Carton Box

| Type | Qty/Bag (Pcs) | Qty/Box (Pcs) | Qty/Carton Pcs | Box size LxWxH (±5) | Carton size LxWxH (±5) | Gross wt ±2 Kgs |
|------|---------------|---------------|----------------|---------------------|------------------------|-----------------|
| ROX7 | 8 | 32 | 1600 | 150 x 75 x 33 | 432 x 308 x 215 | 9.5 |
| ROX8 | 8 | 32 | 1600 | 150 x 75 x 33 | 432 x 308 x 215 | 11.5 |
| ROX9 | 10 | 300 | 1800 | 200 x 171 x 113 | 520 x 215 x 250 | 15 |



Environment Related Substance

This product complies to EU RoHS directive, EU PAHs directive, EU PFOS directive and Halogen free Ozone layer depleting substances.

Ozone depleting substances are not used in our manufacturing process of this product. This product is not manufactured using Chloro fluorocarbons (CFCs), Hydrochlorofluorocarbons (HCFCs), Hydrobromofluorocarbons (HBFCs) or other ozone depleting substances in any phase of the manufacturing process.

Storage Condition

The performance of these products, including the solderability, is guaranteed for a year from the date of arrival at your company, provided that they remain packed as they were when delivered and stored at a temperature of 25°C ± 10°C and a relative humidity of 60%RH ± 10%RH, chemical and dust free atmosphere

Even within the above guarantee periods, do not store these products in the following conditions. Otherwise, their electrical performance and/or solderability may be deteriorated, and the packaging materials (e.g. taping materials) may be deformed or deteriorated, resulting in mounting failures.



1. In salty air or in air with a high concentration of corrosive gas, such as Cl₂, H₂S, NH₃, SO₂, or NO₂
2. In direct sunlight

How To Order

| ROX | 1S | | J | 100K | |
|---------------------------------------------------|--------------------|-------------------|------------------|----------------------------------------------------------------------------------------------------------|--------------------------------------------|
| Common Part | Power Rating | | Tolerance | Resistance Value | Special Request |
| ROX – Flame proof power metal oxide film resistor | Normal size | Small size | G – 2% J – 5% | R33 -0.33Ω 1R0 - 1Ω 10R - 10Ω 100R - 100Ω 1K0 – 1KΩ (1000Ω) 100K – 100KΩ (100,000Ω) | BL * – Pre-formed Leads TR - Reeled |
| | 025 - 1/4W | 05S – 1/2W | | | |
| | 05 – 1/2W | 1S – 1W | | | |
| | 1 – 1W | 2S – 2W | | | |
| | 2 – 2W | 3S – 3W | | | |
| | 3 – 3W | 4S – 4W | | | |
| | 5 – 5W | 5SS – 5W | | | |
| | 7 – 7W | 5S – 5W | | | |
| | 8 – 8W | | | | |
| | 9 – 9W | | | | |

Looking for pricing, stock, or lifecycle information?

Click below to explore more details on WIN SOURCE:

-  [View ROX1SJ180R on WIN SOURCE](#)
-  [TE Connectivity Information](#)

Optimize Your Supply Chain with WIN SOURCE Solutions

-  Global Sourcing Solution
-  Obsolete Management
-  Cost Control Management
-  Shortage Management
-  Alternative Solution
-  Excess Inventory Management