



**THE DATASHEET OF
FH75-40S-0.5SH(99)**



FH75/FH75M Series

0.4mm/0.5mm Pitch, Height 2mm, Bottom Contact,
Front Flip, 2-point Contact, 125°C Compatible, FPC/FFC Connector



TM Flip-Lock Pioneer Hirose

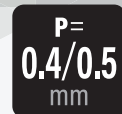

P=0.4/0.5mm



High Temp



Automotive

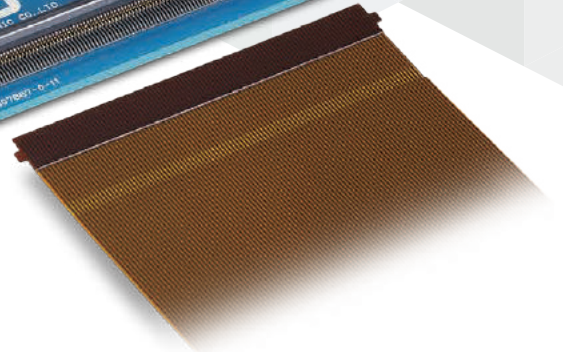
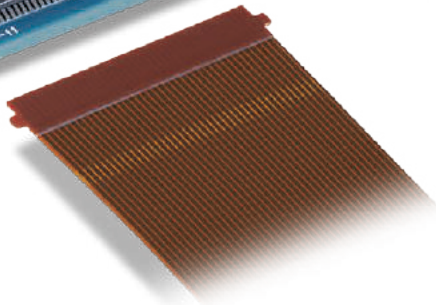
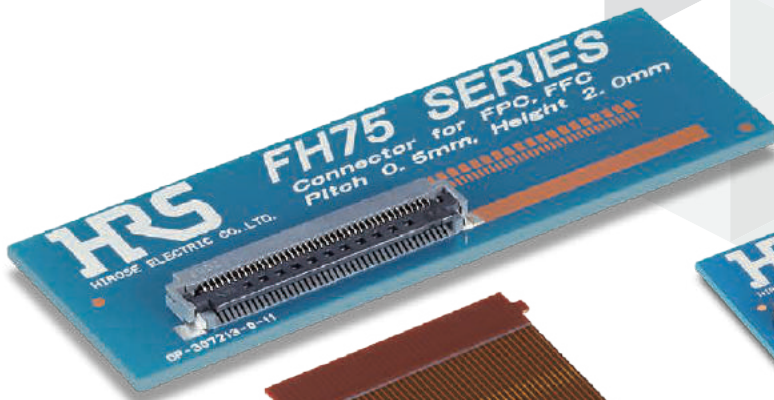

Features

1. Two-point contact design prevents dust intrusion.

Two-point contact with spring prevents dust intrusion and enhances contact reliability.

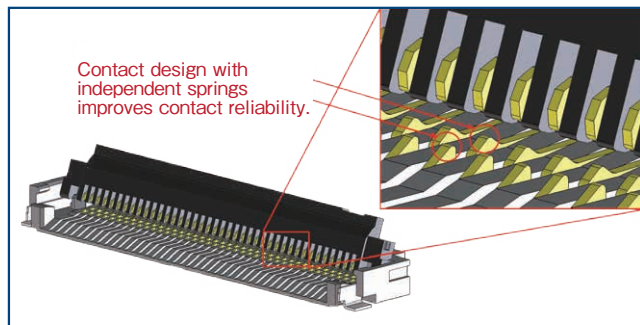

Two-point Contact Design

2. 125°C Heat Resistance

Supports up to 125°C, making FH75/FH75M ideal for applications requiring high heat resistance such as automotive applications.

*When using FFC the heat resistance is up to 105°C.
When the heat resistance of the FPC/FFC is less than 125°C for FPC and 105°C for FFC, the heat resistance of the FPC/FFC is applicable.

3. High FPC/FFC Retention Force

Tall side catches hold FPC/FFC securely for high FPC/FFC retention force.

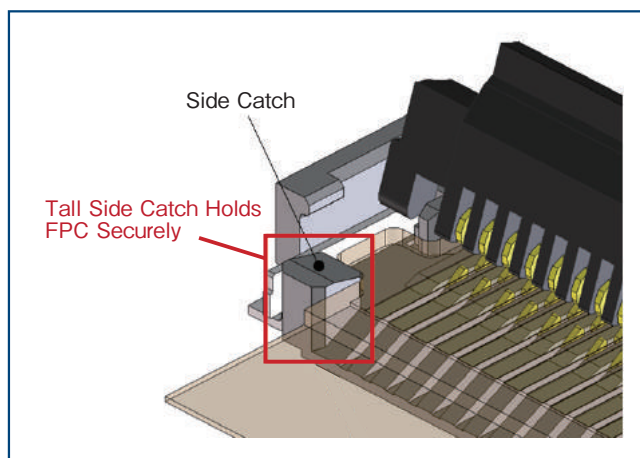

Lock Design Ensures High FPC/FFC Retention Force

4. Original FPC/FFC Mis-Mating Detection Mechanism

Detect incomplete mating by checking the FPC/FFC tab position.

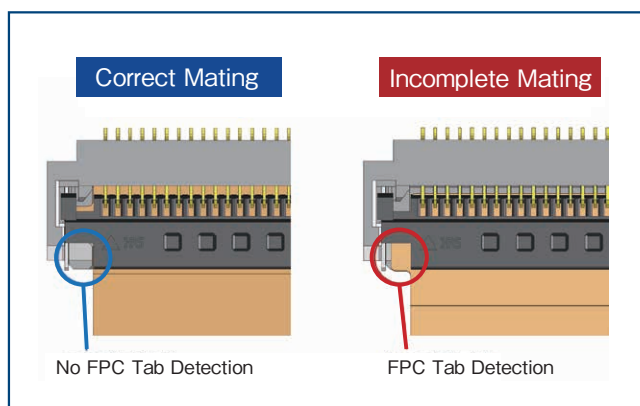

FPC/FFC Mis-Mating Detection

5. PCB Layout Compatible with FH52 Series

FH75 can be used with the same FPC/FFC and PCB pattern as 0.5mm standard connectors FH52E/FH52K/FH52T Series.
FH75M requires a new pattern.

6. Passes Strict Automotive Testing Requirements

FH75 passes rigorous tests for various automotive applications.
(Ex. : Temperature Cycle)
Temperature :
-55→+15 to +35→+125→+15 to +35°C
Time :
30→2 to 3→30→2 to 3min.
1000 cycles repeated under the above conditions

7. Environment Compatibility

Halogen-Free : No chlorine or bromine exceeding the standard value is used in the connector.

*As defined by IEC61249-2-21

Br : 900ppm maximum, Cl : 900ppm maximum,

Cl + Br combined : 1,500ppm maximum

Product Specifications

Rated Current	0.5A (0.5mm Pitch) 0.4A (0.4mm Pitch)	Operating Temperature (Note 1)	-40 to +125°C
Rated Voltage	50V AC/DC (0.5mm Pitch) 40V AC/DC (0.4mm Pitch)	Operating Humidity Range	RH 90% Max. (No Condensation)
		Storage Temperature Range (Note 2)	-10 to +50°C
		Storage Humidity Range (Note 2)	RH 90% Max. (No Condensation)

Note 1 : Includes the temperature rise due to current flow.

When using FFC the heat resistance is up to 105°C .

When the heat resistance of the FPC/FFC is less than 125°C for FPC and 105°C for FFC,
the heat resistance of the FPC/FFC is applicable.

Note 2 : Storage temperature refers to long-term storage of unused parts before board mounting.

The operating temperature and humidity range apply to the non-energized state after board mounting.

Recommended FPC/FFC Specifications	t=0.3 ± 0.05mm Gold Plated
------------------------------------	----------------------------

Item	Specification	Conditions
Insulation Resistance	500M Ω Min.	Measured at 100V DC
Withstanding Voltage	No insulation breakdown	150V AC for 1 min.
Contact Resistance	50m Ω Max. * Includes FPC conductor resistance.	Measured at 1mA (DC or 1000Hz)
Mating Durability	Contact Resistance : 50m Ω Max. No damage, cracks or part dislocation.	20 times
Vibration Resistance	No electrical discontinuity of 1 μs Min. Contact Resistance : 50m Ω Max. No damage, cracks or part dislocation.	Frequency : 10 to 55 Hz, single amplitude of 0.75mm, 10 cycles in each of the 3 axis
Shock Resistance	No electrical discontinuity of 1 μs Min. Contact Resistance : 50m Ω Max. No damage, cracks or part dislocation.	Acceleration of 981m/S ² , 6 ms duration, sine halfwave, 3 cycles in each of the 3 axis
Steady-state Moisture Resistance	Contact Resistance : 50m Ω Max. Insulation Resistance : 50M Ω Min. No damage, cracks or part dislocation.	Left for 1000 hours at 60°C and humidity of 90 to 95%
Operation Cycle	Contact Resistance : 50m Ω Max. Insulation Resistance : 50M Ω Min. No damage, cracks or part dislocation.	Temperature : -55 → +15 to +35 → +125 → +15 to +35°C Time : 30 → 2 to 3 → 30 → 2 to 3 minutes Above conditions repeated for 1000 cycles
Solder Heat Resistance	No deformation in appearance or significant damage to contacts.	Reflow : At the recommended temperature profile Manual soldering : 400 ± 10°C for 5 seconds

Material / Finish

Part	Material	Finish	UL Standard
Insulator	LCP	Gray	UL94V-0
		Black	
Contact	Copper Alloy	Partial Gold Plating	—
Retention Tab	Brass	Pure Tin Plating	

Product Number Structure

Refer to the chart below when determining the product specifications from the product number.
Please select from the product numbers listed in this catalog when placing orders.

FH75

FH75 - 10S - 0.5 SH (01)

① ② ③ ④ ⑤

① Series Name	FH75	④ Termination Type	SH : SMT Horizontal Mounting Type
② No. of Pos.	10, 40, 60, 68	⑤ Specifications	None, (01) : Standard, 3,000pcs per reel (05) : 2,000pcs per reel (61pos. or more) (99) : 500pcs per reel (For trial production)
③ Contact Pitch	0.5mm		

FH75M

FH75M - 100S - 0.4 SH (05)

① ② ③ ④ ⑤

① Series Name	FH75M	④ Termination Type	SH : SMT Horizontal Mounting Type
② No. of Pos.	100	⑤ Specifications	(05) : 2,000pcs per reel (99) : 500pcs per reel (For trial production)
③ Contact Pitch	0.4mm		

FH75

Connector Dimensions

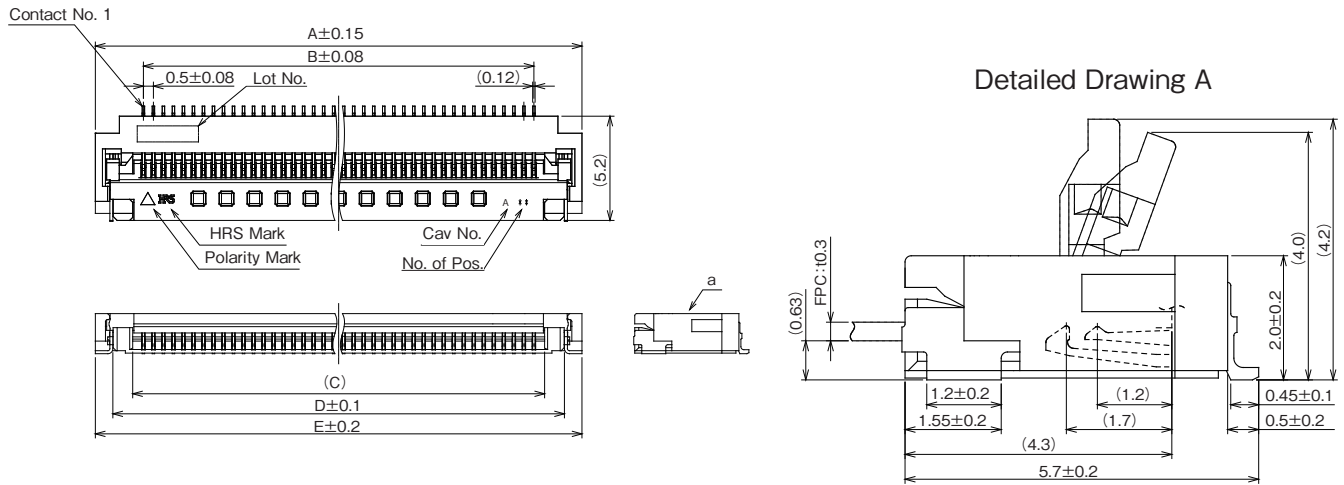

1. The dimensions in parenthesis are for reference.
2. The coplanarity of the contact and retention tab lead should be 0.1mm Max.
3. Packaged in tape and reel. Check the "Packaging Specification" for details.
4. Sink holes may be added for improvements.
5. Black spots may appear on the mold resin but this does not affect the product quality.
6. This product is halogen-free.
(Br : 900ppm maximum, Cl : 900ppm maximum, Cl + Br combined : 1500ppm maximum)

Unit : mm

Part No.	HRS No.	No. of Pos.	A	B	C	D	E	Purchase Unit (##) : None	Purchase Unit (##) : (01)	Purchase Unit (##) : (05)	Purchase Unit (##) : (99)
FH75-8S-0.5SH(##)	Under Planning (Note)	8	8.3	3.5	4.57	6.55	8.3	-	3,000pcs per reel	-	500pcs per reel
FH75-10S-0.5SH(##)	CL0580-5303-0-##	10	9.3	4.5	5.57	7.55	9.3				
FH75-15S-0.5SH(##)	Under Planning (Note)	15	11.8	7.0	8.07	10.55	11.8				
FH75-30S-0.5SH(##)	Under Planning (Note)	30	19.3	14.5	15.57	17.55	19.3	3,000pcs per reel	-	-	
FH75-40S-0.5SH(##)	CL0580-5300-0-##	40	24.3	19.5	20.57	22.55	24.3	-	3,000pcs per reel	2,000pcs per reel	
FH75-50S-0.5SH(##)	Under Planning (Note)	50	29.3	24.5	25.57	27.55	29.3				
FH75-60S-0.5SH(##)	CL0580-5301-0-##	60	34.3	29.5	30.57	32.55	34.3				
FH75-68S-0.5SH(##)	CL0580-5309-0-##	68	38.3	33.5	34.57	36.55	38.3	-	-	-	
FH75-80S-0.5SH(##)	Under Planning (Note)	80	44.3	39.5	40.57	42.55	44.3	-	-	-	

Note : Products without HRS No. are currently being planned for development. Please contact a Hirose representative regarding questions on pin count variation development.

Recommended PCB Layout

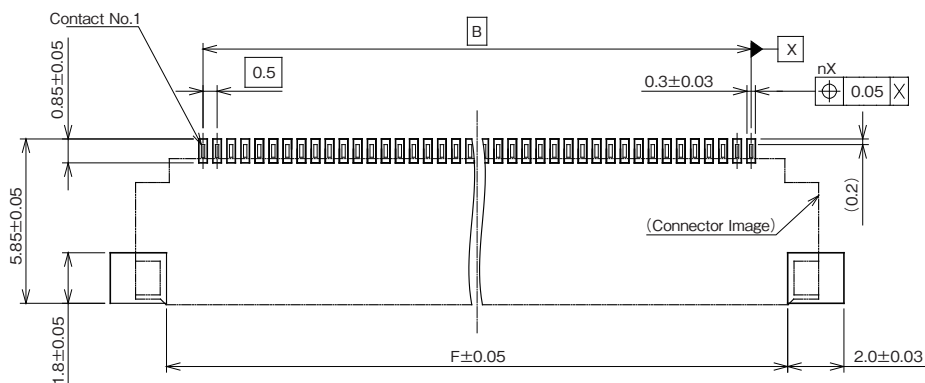

Recommended Metal Mask Dimensions

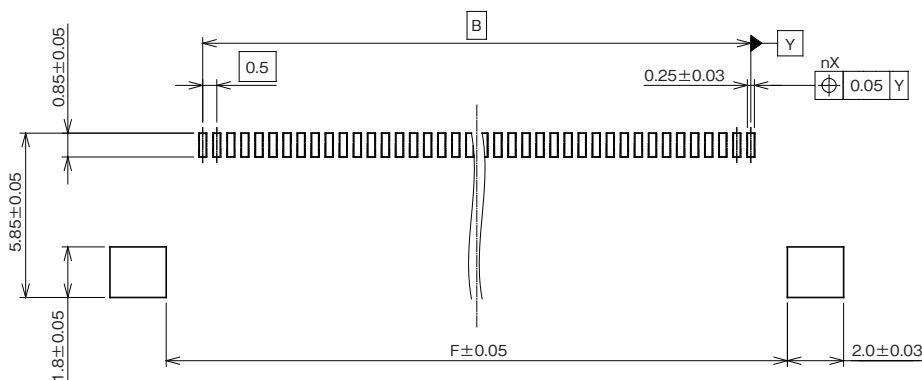

(Recommended Metal Mask Thickness: $t=0.12$)

'n' indicates the number of positions.

Unit : mm

Part No.	HRS No.	No. of Pos.	B	F
FH75-8S-0.5SH(##)	Under Planning (Note)	8	3.5	6.1
FH75-10S-0.5SH(##)	CL0580-5303-0-##	10	4.5	7.1
FH75-15S-0.5SH(##)	Under Planning (Note)	15	7.0	9.6
FH75-30S-0.5SH(##)	Under Planning (Note)	30	14.5	17.1
FH75-40S-0.5SH(##)	CL0580-5300-0-##	40	19.5	22.1
FH75-50S-0.5SH(##)	Under Planning (Note)	50	24.5	27.1
FH75-60S-0.5SH(##)	CL0580-5301-0-##	60	29.5	32.1
FH75-68S-0.5SH(##)	CL0580-5309-0-##	68	33.5	36.1
FH75-80S-0.5SH(##)	Under Planning (Note)	80	39.5	42.1

Note : Products without HRS No. are currently being planned for development. Please contact a Hirose representative regarding questions on pin count variation development.

Recommended FPC/FFC Layout

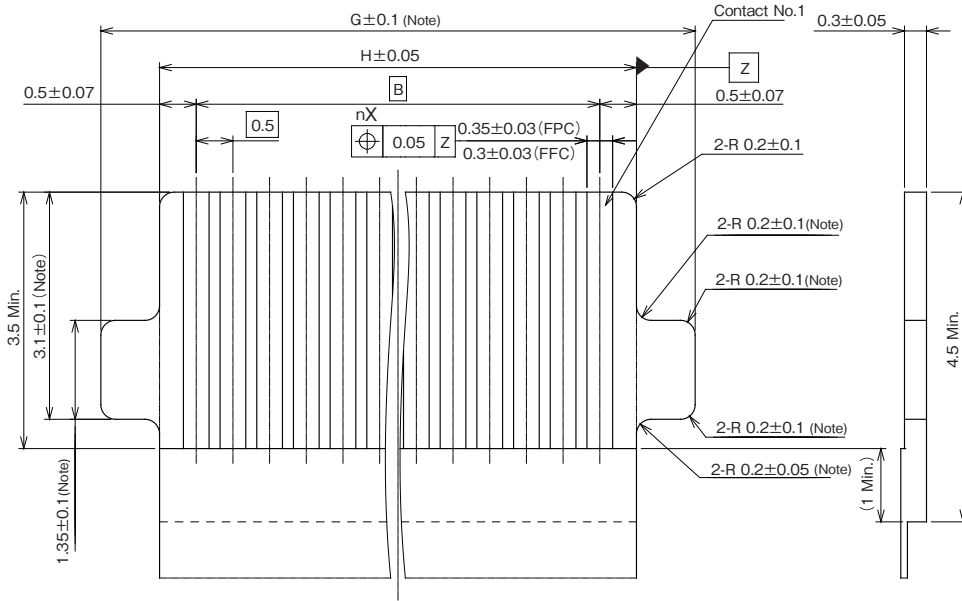

'n' indicates the number of positions.

Note : FPC/FFC without tabs can also be used. When using FPC/FFC without tabs, the specified location dimensions are not required.

Unit : mm

Part No.	HRS No.	No. of Pos	B	G	H
FH75-8S-0.5SH(##)	Under Planning (Note)	8	3.5	6.1	4.5
FH75-10S-0.5SH(##)	CL0580-5303-0-##	10	4.5	7.1	5.5
FH75-15S-0.5SH(##)	Under Planning (Note)	15	7.0	9.6	8.0
FH75-30S-0.5SH(##)	Under Planning (Note)	30	14.5	17.1	15.5
FH75-40S-0.5SH(##)	CL0580-5300-0-##	40	19.5	22.1	20.5
FH75-50S-0.5SH(##)	Under Planning (Note)	50	24.5	27.1	25.5
FH75-60S-0.5SH(##)	CL0580-5301-0-##	60	29.5	32.1	30.5
FH75-68S-0.5SH(##)	CL0580-5309-0-##	68	33.5	36.1	34.5
FH75-80S-0.5SH(##)	Under Planning (Note)	80	39.5	42.1	40.5

Note : Products without HRS No. are currently being planned for development. Please contact a Hirose representative regarding questions on pin count variation development.

FH75M

Connector Dimensions

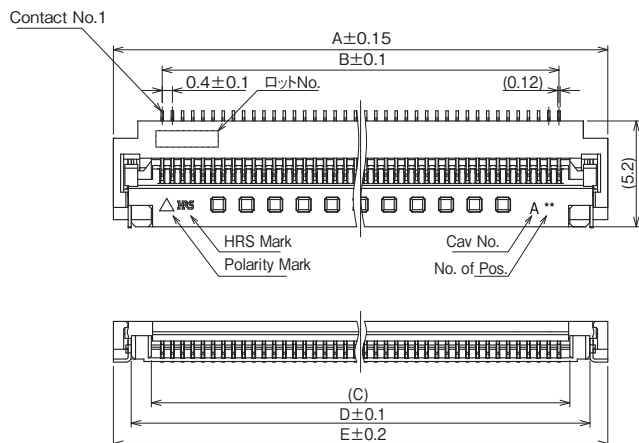

Detailed Drawing A

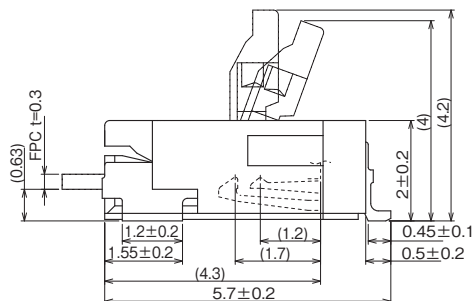

Unit : mm

Part No.	HRS No.	No. of Pos.	A	B	C	D	E	Purchase Unit (##) : (05)	Purchase Unit (##) : (99)
FH75M-80S-0.4SH(##)	Under Planning (Note)	80	36.2	31.6	32.5	34.5	36.2	2,000pcs per reel	500pcs per reel
FH75M-100S-0.4SH(##)	CL0580-5306-0-##	100	44.2	39.6	40.5	42.5	44.2		
FH75M-120S-0.4SH(##)	Under Planning (Note)	120	52.2	47.6	48.5	50.5	52.2		

Note : Products without HRS No. are currently being planned for development. Please contact a Hirose representative regarding questions on pin count variation development.

Recommended PCB Layout

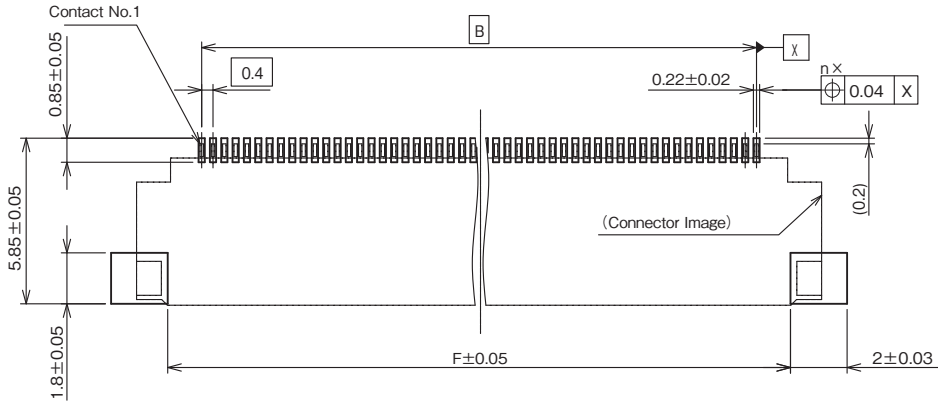

Recommended Metal Mask Dimensions

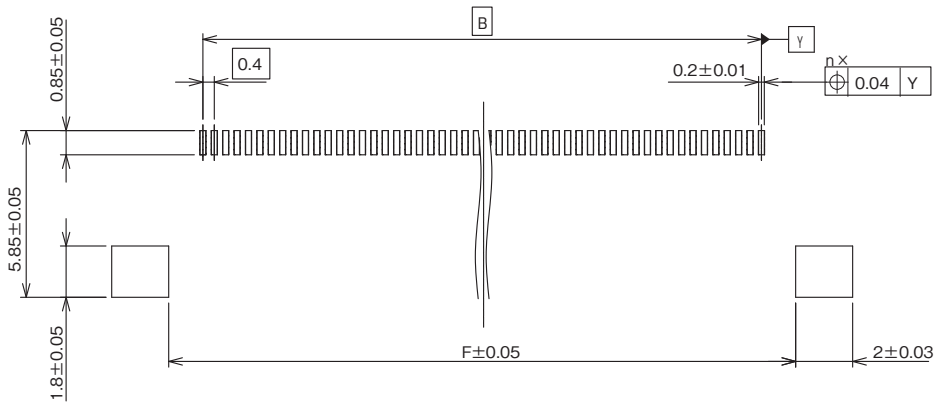

Unit : mm

Part No.	HRS No.	No. of Pos.	B	F
FH75M-80S-0.4SH(##)	Under Planning (Note)	80	31.6	34.0
FH75M-100S-0.4SH(##)	CL0580-5306-0-##	100	39.6	42.0
FH75M-120S-0.4SH(##)	Under Planning (Note)	120	47.6	50.0

Note : Products without HRS No. are currently being planned for development. Please contact a Hirose representative regarding questions on pin count variation development.

Recommended FPC/FFC Layout

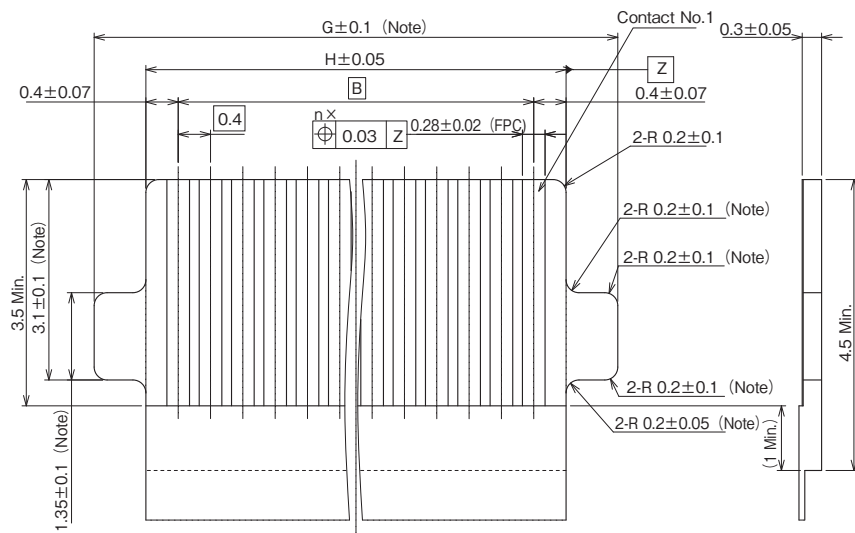

'n' indicates the number of positions.

Note : FPC/FFC without tabs can also be used. When using FPC/FFC without tabs, the specified location dimensions are not required.

Unit : mm

Part No.	HRS No.	No. of Pos.	B	G	H
FH75M-80S-0.4SH(##)	Under Planning (Note)	80	31.6	34.0	32.4
FH75M-100S-0.4SH(##)	CL0580-5306-0-##	100	39.6	42.0	40.4
FH75M-120S-0.4SH(##)	Under Planning (Note)	120	47.6	50.0	48.4

Note : Products without HRS No. are currently being planned for development. Please contact a Hirose representative regarding questions on pin count variation development.

Recommended FPC/FFC Construction

Single-Sided FPC

FPC: Flexible Printed Circuit

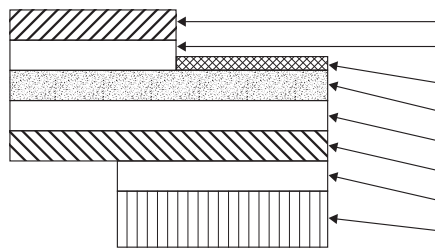

Material Name	Material	Thickness (μm)
Cover Film Layer	Polymide 1mil	(25)
Cover Adhesive	1/2 oz	(18)
Surface Treatment	0.2μm thick gold plated over 1 to 5μm thick nickel underplating	3
Copper Foil	Cu 1oz	35
Base Adhesive	Thermosetting Adhesive	25
Base Film	Polymide 1mil thick	25
Reinforcement Material	Thermosetting Adhesive	30
Stiffener	Polymide 7mil thick	175
Total		293

Double-Sided FPC

FPC: Flexible Printed Circuit

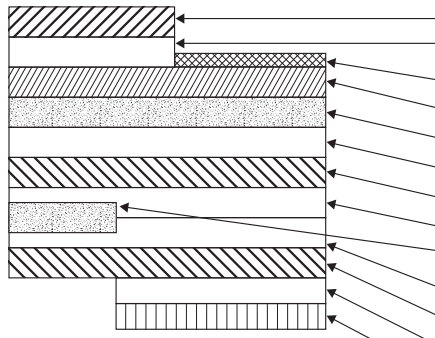

Material Name	Material	Thickness (μm)
Cover Film Layer	Polymide 1mil	(25)
Cover Adhesive		(25)
Surface Treatment	0.2μm thick gold plated over 1 to 5μm thick nickel underplating	3
Through-hole Copper	Cu	15
Copper Foil	Cu 1/2 oz	18
Base Adhesive	Thermosetting Adhesive	18
Base Film	Polymide 1mil thick	25
Base Adhesive	Thermosetting Adhesive	18
Copper Foil	Cu 1/2 oz	(18)
Cover Adhesive	Thermosetting Adhesive	25
Covering Film Layer	Polymide 1mil thick	25
Reinforcement Material	Thermosetting Adhesive	50
Stiffener	Polymide 4mil thick	100
Total		297

Use of double-sided FPC with copper foil is not recommended in order to prevent release of the FPC due to bending.

FFC

FFC: Flexible Flat Cable

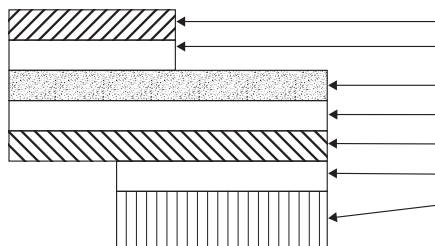

Material Name	Material	Thickness (μm)
Polyester Film		(12)
Adhesive	Thermoplastic Polyester	(30)
Gold Plated Anneal Copper Foil		35
Adhesive	Polyester	30
Polyester		12
Adhesive	Polyester	30
Stiffener	Polyester	188
Total		295

*tolerance of ±20μm

- These specifications are recommended for the construction of the FH75/FH75M Series FPC/FFC ($t=0.3 \pm 0.05\text{mm}$)
The FPC/FFC should be manufactured so that the thickness of the mated portion is $0.3 \pm 0.05\text{mm}$ in reference to the above Recommended FPC/FFC Construction.
- For details about the construction, please contact FPC/FFC manufacturers.

Packaging Specifications

FH75

Embossed Carrier Tape Dimensions

Tape Width : 24mm Max.

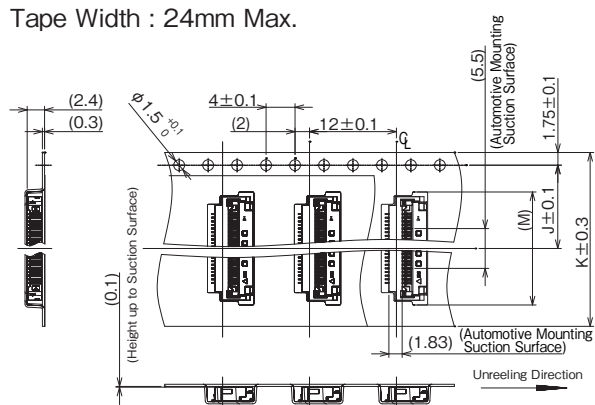

Tape Width : 32mm Min.

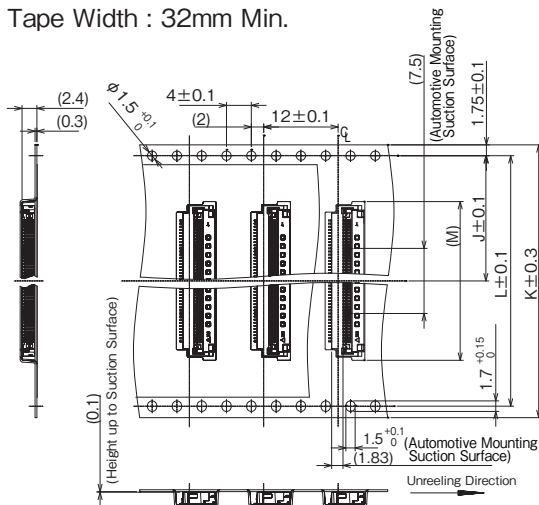

Reel Dimensions

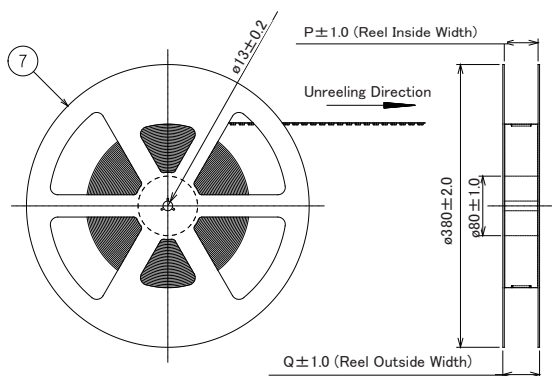

Leader, Trailer Dimensions

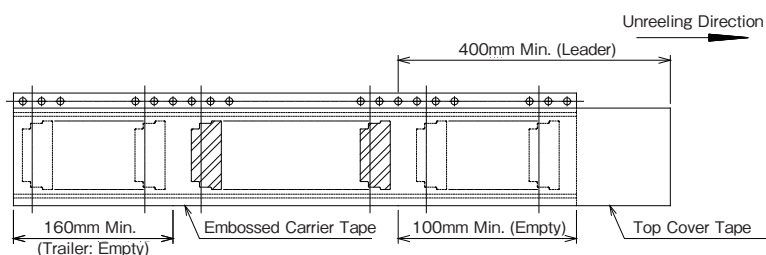

3,000pcs per reel (standard product).

2,000pcs per reel (61pos. or more)

This packaging meets JIS C 0806 and IEC 60286-3 (Packaging of Components for Automatic Handling) standards.

Unit : mm

Part No.	HRS No.	No. of Pos.	J	K	L	M	P	Q
FH75-8S-0.5SH(##)	Under Planning (Note)	8	11.5	24.0	-	9.6	25.4	29.4
FH75-10S-0.5SH(##)	CL0580-5303-0-##	10	11.5	24.0	-	10.6	25.4	29.4
FH75-15S-0.5SH(##)	Under Planning (Note)	15	11.5	24.0	-	13.1	25.4	29.4
FH75-30S-0.5SH(##)	Under Planning (Note)	30	20.2	44.0	40.4	20.6	45.4	49.4
FH75-40S-0.5SH(##)	CL0580-5300-0-##	40	20.2	44.0	40.4	25.6	45.4	49.4
FH75-50S-0.5SH(##)	Under Planning (Note)	50	20.2	44.0	40.4	30.6	45.4	49.4
FH75-60S-0.5SH(##)	CL0580-5301-0-##	60	26.2	56.0	52.4	35.6	57.4	61.4
FH75-68S-0.5SH(##)	CL0580-5309-0-##	68	26.2	56.0	52.4	39.6	57.4	61.4
FH75-80S-0.5SH(##)	Under Planning (Note)	80	34.2	72.0	68.4	45.6	73.4	77.4

Note : Products without HRS No. are currently being planned for development. Please contact a Hirose representative regarding questions on pin count variation development.

FH75M

Embossed Carrier Tape Dimensions

Tape Width : 32mm Min.

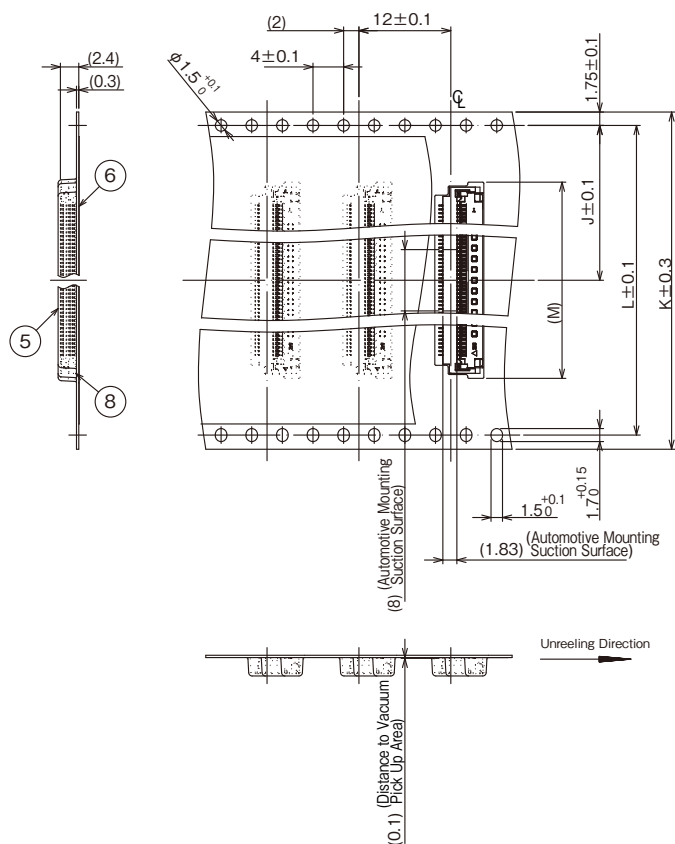

Reel Dimensions

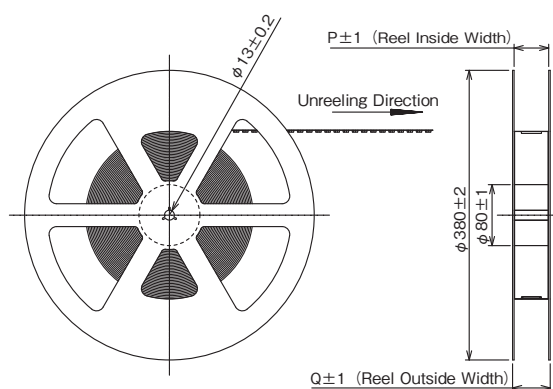

Leader, Trailer Dimensions

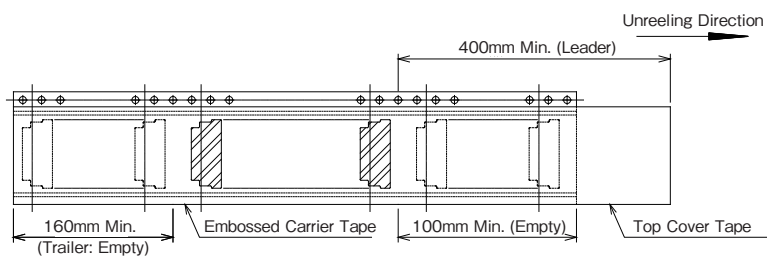

2,000pcs per reel.

This packaging meets JIS C 0806 and IEC 60286-3 (Packaging of Components for Automatic Handling) standards.

Unit : mm

Part No.	HRS No.	No. of Pos.	J	K	L	M	P	Q
FH75M-80S-0.4SH(##)	Under Planning (Note)	80	26.2	56.0	52.4	37.6	57.4	61.4
FH75M-100S-0.4SH(##)	CL0580-5306-0-##	100	34.2	72.0	68.4	45.6	73.4	77.4
FH75M-120S-0.4SH(##)	Under Planning (Note)	120	34.2	72.0	68.4	53.5	73.4	77.4

Note : Products without HRS No. are currently being planned for development. Please contact a Hirose representative regarding questions on pin count variation development.

Temperature Profile

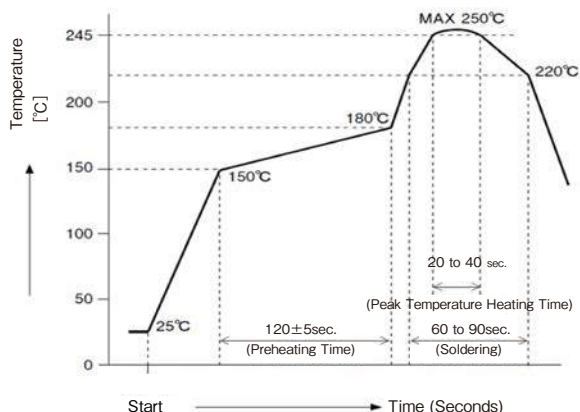

Applicable Conditions

Solder Method	: Reflow, IR/Hot Air
Environment	: Room air
Solder Composition	: Paste Sn/3.0Ag/0.5Cu (SENJU METAL INDUSTRY CO., LTD. Part Number:M705-GRN360-K2-V)
Test Board	: Material and Size Glass epoxy 80x100x1.6mm Land Dimensions "Recommended PCB Layout"
Metal Mask	: Thick and Opening dimensions "Recommended Metal Mask Dimensions"

This temperature profile is for the above applicable conditions. The temperature profile may vary depending on the type of cream solder, the manufacturer, the board size, and other conditions such as mounting materials. Please check the mounting status before use.

Operation and Precautions

【Operating Method】

Please use this connector after confirming the following operation instructions in order to prevent connector or FPC damage and contact failure (incomplete mating, FPC pattern disconnection).

This connector is compatible with both FPC and FFC but only FPC is listed for convenience.

1. Initial Delivery State

The actuator is locked in the initial delivery state.

Delivery State

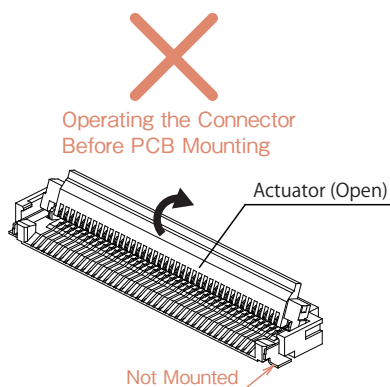
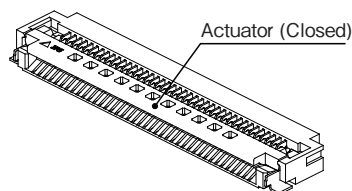

2. How to Release Actuator Lock

Rotate the actuator at its center. Slowly rotate the actuator to release the lock.

OK

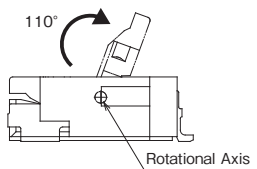

OK

Operate Actuator Near its Center

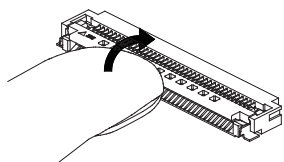

OK

Operating Both Ends of the Actuator Simultaneously

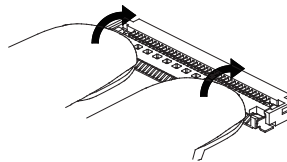

Operating the Actuator at One End

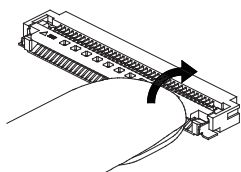

Pressing Against the Actuator

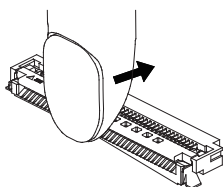

Putting Fingernails or Tools inside the Connector

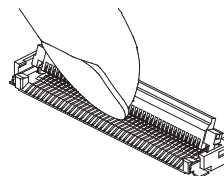

Applying Excessive Load to the Actuator

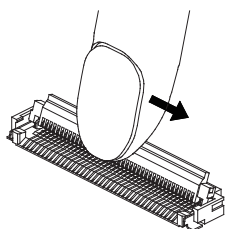

Lifting Up the Actuator

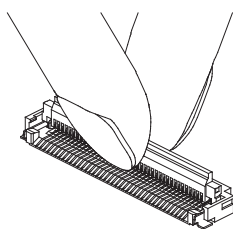

3. FPC Insertion and Removal Method

This connector is a bottom contact type. There is an FPC positioning boss on the connector. Insert the FPC with the FPC conductor face down and the FPC at a 10° upward angle in respect to the board. If there is no FPC positioning tab, insert the FPC parallel to the board surface. When removing the FPC, unlock the actuator and pull out the FPC upward at a 10° angle with respect to the board surface. When there is no FPC positioning tab, remove the FPC by pulling it out horizontally in respect to the board surface.

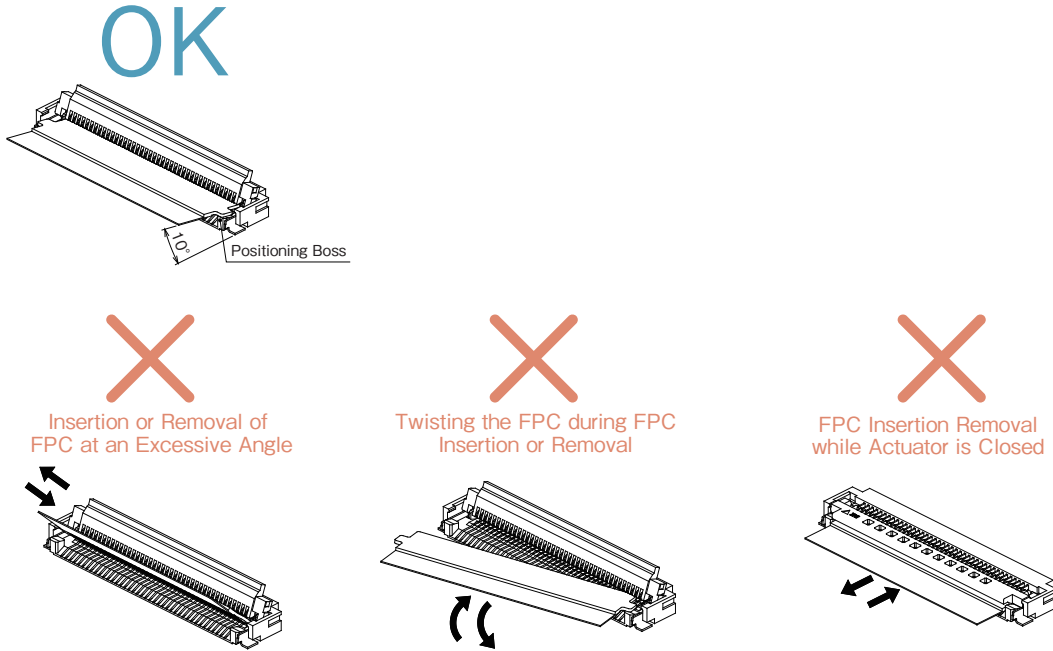

4. Confirm that FPC Insertion is Completed and the Actuator is Locked

The FPC position is determined using the FPC positioning boss. After FPC insertion is completed and the actuator is locked, check whether the FPC positioning tabs are in the below indicated positions.

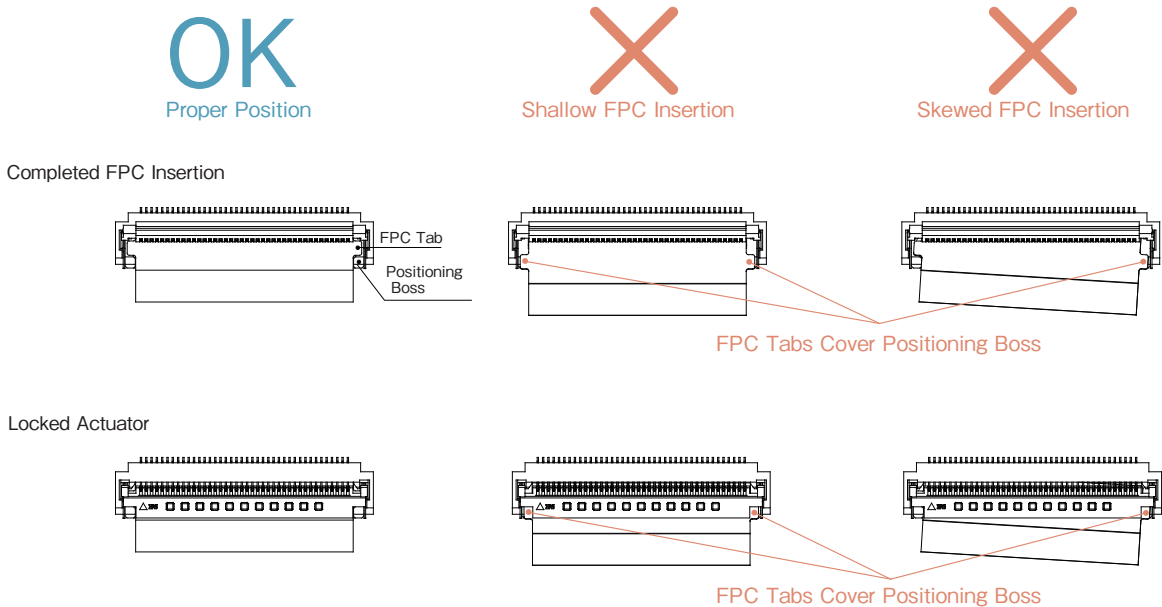

5. Actuator Locking and Release Method

Rotate the actuator at its center.

Locking : Rotate the actuator to lock.

Release : Slowly push the actuator upward to release the lock.

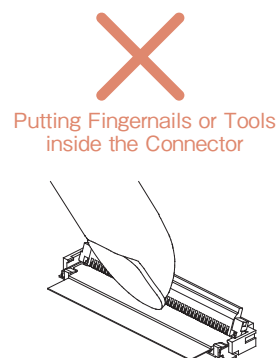
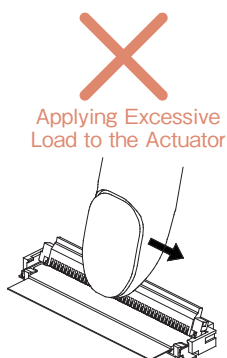
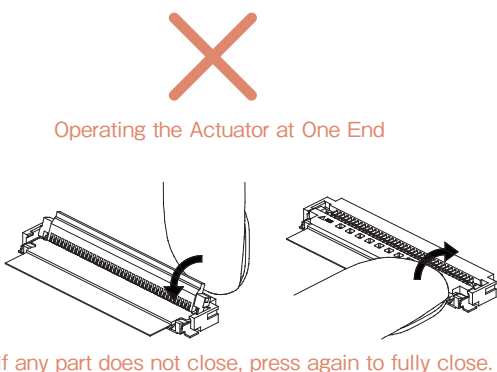
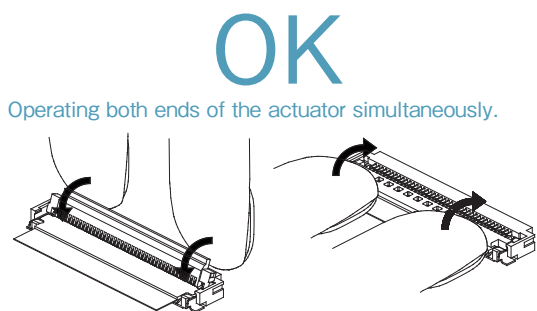
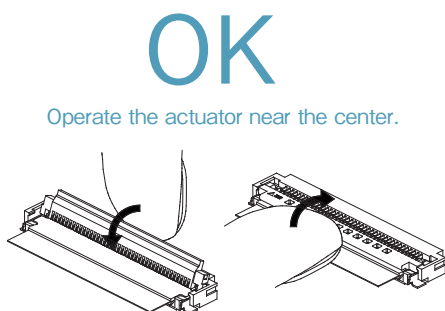
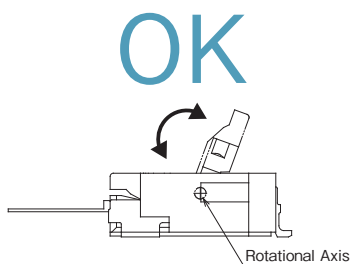

PCB Layout Precautions

Design the board layout so that no load is applied to the connector or FPC.

[Cautions]

- Route the FPC so that it has leeway and is not pulled. Make sure that the reinforcing film is horizontal to the board surface.
- Do not place interfering components under the FPC.
- Check with the FPC manufacture regarding FPC flexibility.
- When designing the board/layout, ensure that there is enough space to operate and close the actuator.
- Consult with a Hirose representative about usage of FPC size and shape different from what is recommended.

OK

No Load on Reinforcement Film

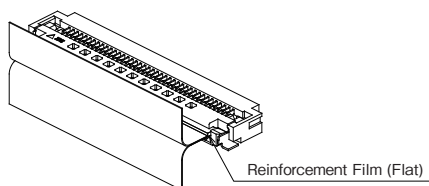

Load on Reinforcement Film



Load on FPC



Casing and Components Interfering with FPC

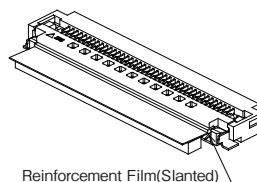
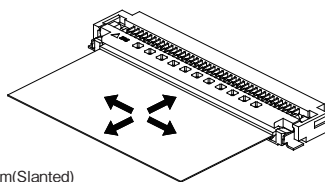
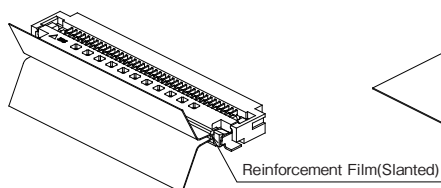

Board Mounting Precautions

- Please check the recommended mounting PCB land shape, metal mask opening and FPC. When using a pattern different from the recommendations, check the mounting condition before use.
- Check the mounting condition before use when there is silk printing below the connector.
- The reflow conditions must be within the specifications. Mounting conditions may be affected by the type of solder paste manufacturer, PCB size and other mounted components. Please check the mounting conditions before use.
- Keep board warpage to a minimum. The coplanarity of this connector is 0.1mm Max. Soldering failure may occur due to excessive board warpage.
- When mounting the FPC, design a reinforcing plate for easy handling. Reinforcing plates made of glass epoxy with a thickness of 0.3mm Min. are recommended.
- Do not apply excessive force to the connector before mounting, such as pulling the emboss out from the reel or suctioning the connector from the emboss. (0.5N Max.)

Handling Precautions After PCB Mounting

Board warpage may place a load to the connector and result in damage.

- Avoid placing a load to the board during assembly processes such as by splitting a board into several pieces or screwing the board.
- The warpage of a 100mm wide board should be 0.5mm or less.

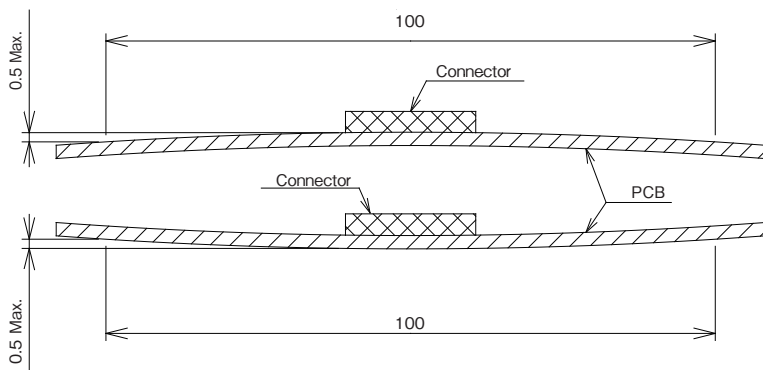

Manual Soldering

- Do not perform manual soldering with the FPC inserted into the connector.
- Do not heat the connector excessively or let the soldering iron touch any parts other than the contact leads.
- Do not use excessive solder (or flux).

While Taking into Consideration

Specifications mentioned in this catalog are reference values.

When considering to order or use this product, please review the Drawing and Product Specifications sheets.

Use an appropriate cable when using the connector in combination with cables.

If considering usage of a non-specified cable, please contact your sales representative.

If assembly process is done by jigs & tools which are not identified by Hirose, the warranty of the product may be affected.

If considering usage for below mentioned applications, please contact your sales representative.

In cases where the application will demand a high level of reliability, such as automotive, medical instruments, public infrastructure, aerospace/defense etc. Hirose must review before assurance of reliability can be given.

HIROSE

HRS HIROSE ELECTRIC CO.,LTD.

2-6-3 Nakagawa Chuoh, Tsuzuki-Ku, Yokohama-Shi 224-8540, JAPAN
<https://www.hirose.com>

Looking for pricing, stock, or lifecycle information?

Click below to explore more details on WIN SOURCE:

-  [View FH75-40S-0.5SH\(99\) on WIN SOURCE](#)
-  [Hirose Electric Co Ltd Information](#)

Optimize Your Supply Chain with WIN SOURCE Solutions

-  Global Sourcing Solution
-  Obsolete Management
-  Cost Control Management
-  Shortage Management
-  Alternative Solution
-  Excess Inventory Management