



**THE DATASHEET OF
MF0207FTE52-3K32**



DATA SHEET

METAL FILM RESISTORS

Professional
MFO Series

$\pm 0.5\%$, $\pm 1\%$, $\pm 2\%$, $\pm 5\%$

0.4W AND 0.6W

RoHS compliant & Halogen Free





ORDERING INFORMATION

Part number of the professional t metal film resistor are identified by the series, power rating, tolerance, packing, temperature coefficient, forming and resistance value.

APPLICATIONS

- All general purpose applications
- Power applications

FEATURES

- AEC-Q200 qualified
- Wide resistance range
- Miniature & high power rating
- High stability
- RoHS compliant & halogen-free

PART NUMBER

MF0 **204** **F** **I** **F** **52-** **100R**
 (1) (2) (3) (4) (5) (6) (7)

(1) SERIES

MF0 Series

(2) POWER RATING

204 = 0.4W

207 = 0.6W

(3) TOLERANCE

D = ±0.5%

J = ±5%

F = ±1%

- = for 0R

G = ±2%

(4) PACKAGING

R = Reel Pack

B = Bulk

T = Box Pack

(5) TEMPERATURE COEFFICIENT OF RESISTANCE

E=±50ppm/°C

- = for 0R

F=±100ppm/°C

(6) FORMING

26- = 26mm

M = M-Type Forming

52- = 52.4mm

MB = M-form W/flat

52B = 52.4mm, Φd =0.45±0.02mm

MT = MT Type Forming

52C = 52.4mm, Φd= 0.5±0.02mm

FT = FT Type Forming

52H = 52.4mm, non-painting on soldering spots

PN = PANAsert

AV = AVIsert

Note: 26mm and 52.4mm represent dimension A of the axial type, please refer to the category of AXIAL/REEL TAPE SPECIFICATION for the detail.

(7) RESISTANCE VALUE

E24 & E96 Series

Example:

100R = 100Ω, 10K = 10,000Ω, 1M = 1,000,000Ω

DIMENSIONS

Unit: mm



Miniature	L	ψD	H	ψd
MF0204	3.4 ± 0.3	1.9 ± 0.2	28 ± 2.0	0.45 ± 0.05
MF0207	6.3 ± 0.5	2.4 ± 0.2	28 ± 2.0	0.55 ± 0.05

DERATING CURVE

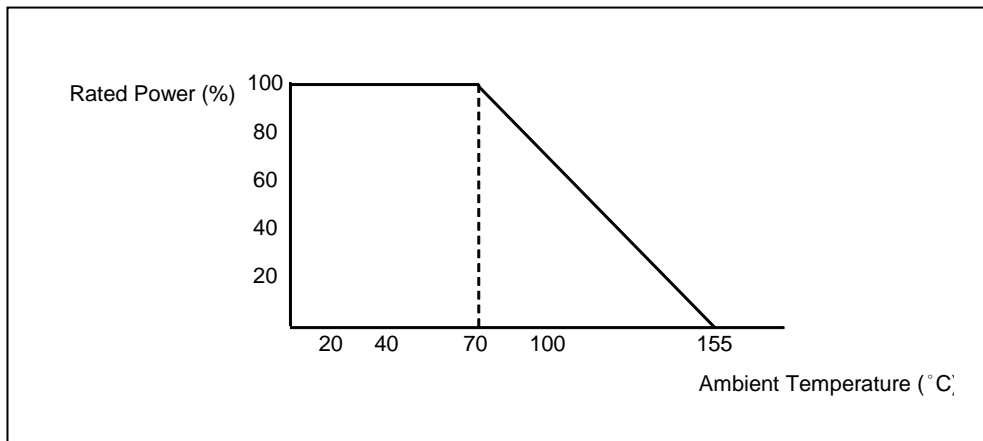

ELECTRICAL CHARACTERISTICS

CHARACTERISTICS	MF0204	MF0207
Power Rating at 70 °C	0.4W	0.6W
Maximum Working Voltage	250V	350V
Maximum Overload Voltage	500V	700V
Voltage Proof on Insulation	300V	500V
Resistance Range	1Ω ~4M7Ω for E24&E96 series value	
Operating Temp. Range	- 55°C to +155°C	
Temperature Coefficient	±50ppm/°C, ±100ppm/°C	

Note: For resistance value out of above range is by request.

ELECTRICAL CHARACTERISTICS FOR 0R

TYPE	MF0204	MF0207
Power Rating at 70 °C	0.4W	0.6W
Maximum Current Rating at 70 °C	1.5A	2.5A
Voltage Proof on Insulation	300V	500V
Resistance Range	0R	
Operating Temp. Range	- 55°C to +155°C	

TEST AND REQUIRMENTS

TEST	TEST METHOD	PROCEDURE	APPRAISE
Short Time Overload	IEC 60115-1 4.13	2.5 times RCWV for 5 sec.(Not more than maximum overload voltage)	±0.25%+0.05Ω for MF0207 type ±1.0 % +0.05Ω for MF0204 type
Voltage Proof on Insulation	IEC 60115-1 4.7	In V-Block for 60 sec. test voltage as above table	No Breakdown
Temperature Coefficient	IEC 60115-1 4.8	Between -55°C to +155°C	By Type
Insulation Resistance	IEC 60115-1 4.6	In V-Block for 60 sec.	>10,000MΩ
Solderability	IEC 60115-1 4.17	245±5°C for 3±0.5 Sec.	95% Min. coverage
Solvent Resistance of Marking	IEC 60115-1 4.30	IPA for 5±0.5 Min. with ultrasonic	No deterioration of coatings and markings
Robustness of Terminations	IEC 60115-1 4.16	Direct load for 10 Sec. in the direction of the terminal leads	≥2.5Kg(24.5N)
Periodic-pulse Overload	IEC 60115-1 4.39	4 times RCWV(or Umax., whichever less) 10,000 cycles (1 Sec. on, 25 Sec.off)	±1.0%+0.05Ω
Damp Heat Steady State	IEC 60115-1 4.24	40±2°C,90-95% RH for 56 days, loaded with 0.1 times RCWV(or Umax., whichever less)	±1.5%+0.05Ω
Endurance at 70°C	IEC 60115-1 4.25	70±2°C at RCWV(or Umax., whichever less) for 1,000 Hr.(1.5 Hr.on,0.5 Hr. off)	±1.5%+0.05Ω
Temperature Cycling	IEC 60115-1 4.19	-55°C → Room Temp. → +155°C → Room Temp.(5 cycles)	±0.75%+0.05Ω
Resistance to Soldering Heat	IEC 60115-1 4.18	260±3°C for 10±1 Sec., immersed to a point 3±0.5mm from the body	±0.25%+0.05Ω

Note:.

RCWV (Rated Continuous Working Voltage):

The DC or AC (rms) continuous working voltage corresponding to the rated power is determined by the following formula:

$$V=\sqrt{(P \times R)}$$

or max. working voltage whichever is less

Where

V=Continuous rated DC or
AC (rms) working voltage (V)

P=Rated power (W)

R=Resistance value (Ω)

AXIAL / REEL TAPE SPECIFICATION

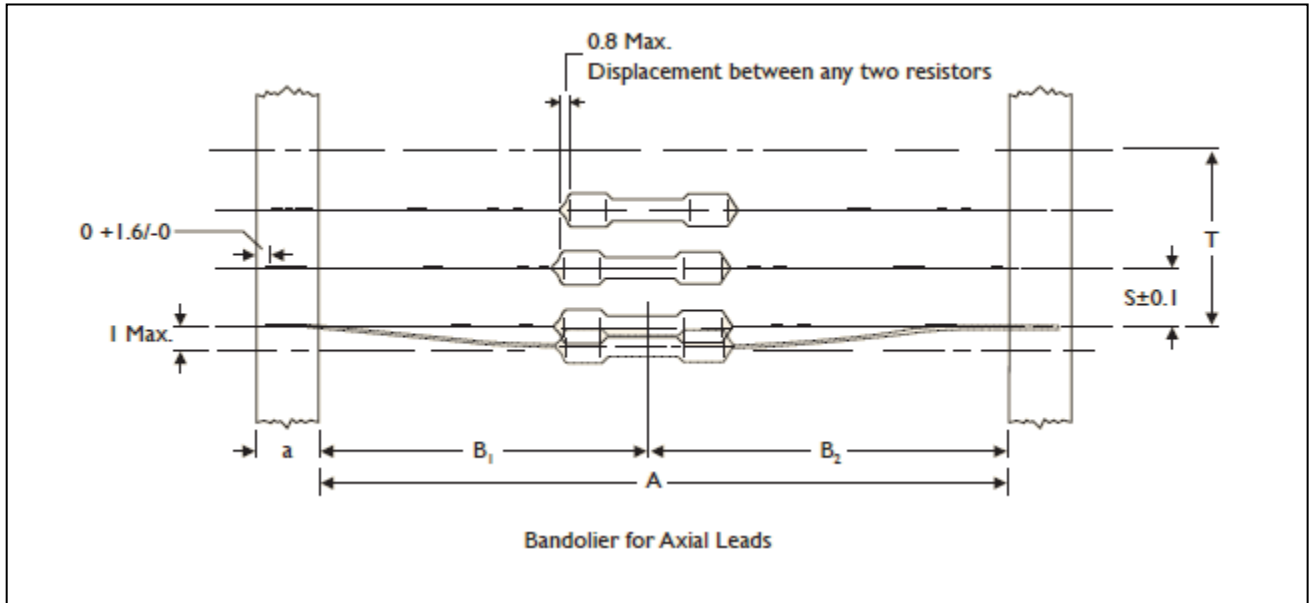

Unit: mm

Miniature	a	A	B1-B2 (Max.)	S (spacing)	T (max. deviation of spacing)
MF0204	6 ± 0.5	52.4 ± 1.5	1.2	5	0.5 mm per 5 spacing
		26.0 ± 1.5	1		
MF0207	6 ± 0.5	52.4 ± 1.5	1.2	5	0.5 mm per 5 spacing
		26.0 ± 1.5	1		

TAPE ON REEL PACKING

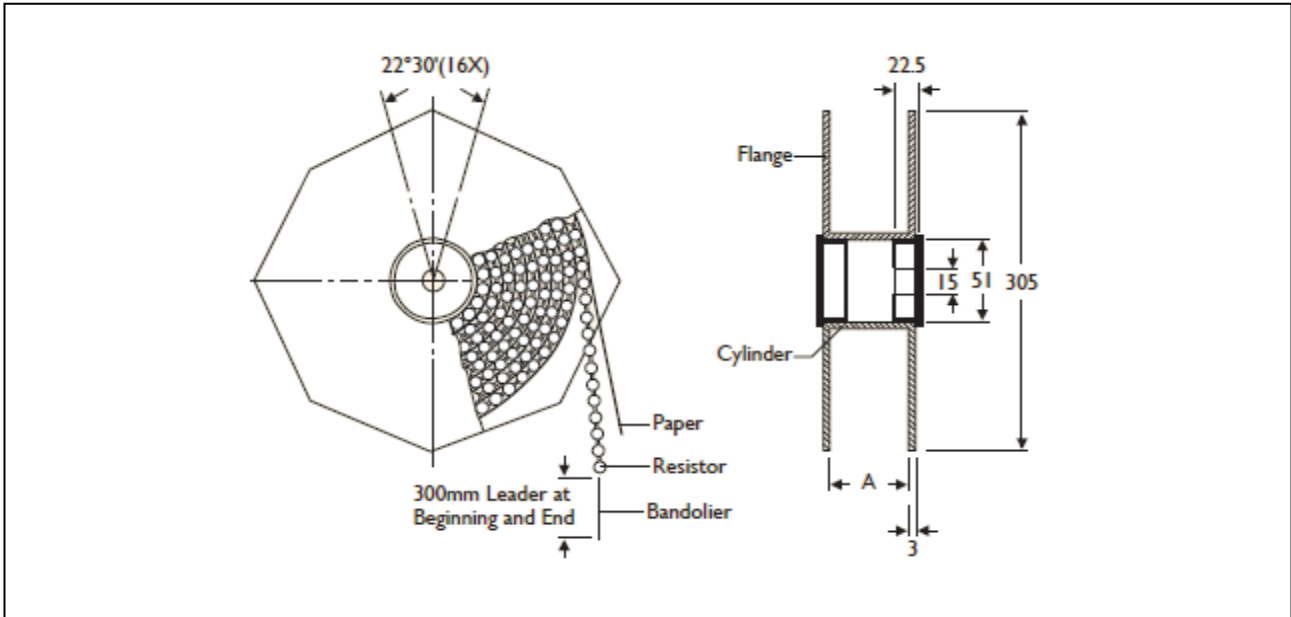

TYPE

Unit: mm/piece

Miniature	Across Flange(A)	B	Quantity Per Reel
MF0204	66.5	75.5	5,000
MF0207	66.5	75.5	5,000

TAPE ON BOX PACKING

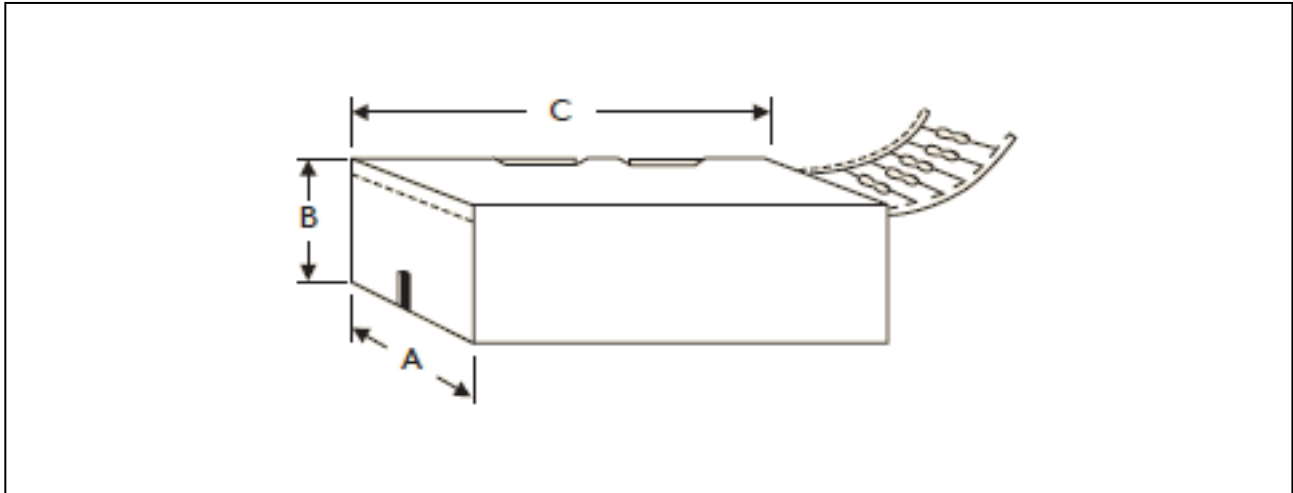

TYPE	DIMENSIONS			Unit: mm/piece
	A	B	C	Quantity Per Box
Miniature				
MF0204	48	102	255	5,000
MF0204	81	70	260	5,000
MF0207	48	102	255	5,000
MF0207	81	104	260	5,000

BULK PACKING

Miniature	Piece/Per Inner Box	Bag/Per Inner Box	Piece Per Bag
MF0204	10,000	10	1,000
MF0207	10,000	10	1,000

FORMING

M TYPE

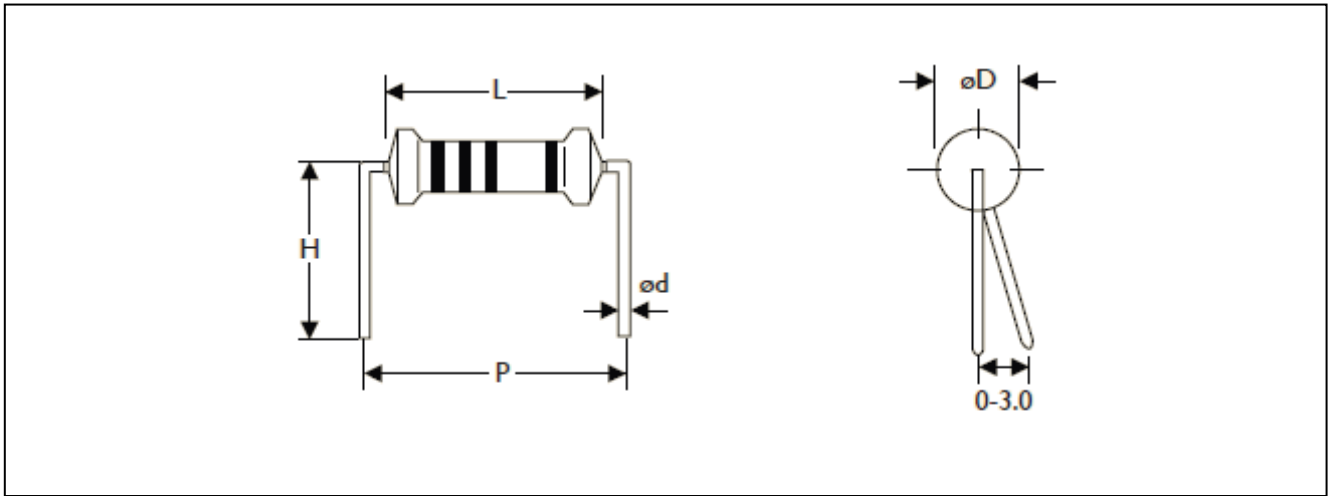

TYPE	DIMENSIONS					Unit: mm
Miniature	L	ψD	ψd	P	H	
MF0204	3.4 ± 0.3	1.9 ± 0.2	0.45 ± 0.05	6.0 ± 1	10.0 ± 1	
MF0207	6.3 ± 0.5	2.4 ± 0.2	0.55 ± 0.05	10.0 ± 1	10.0 ± 1	

MB TYPE

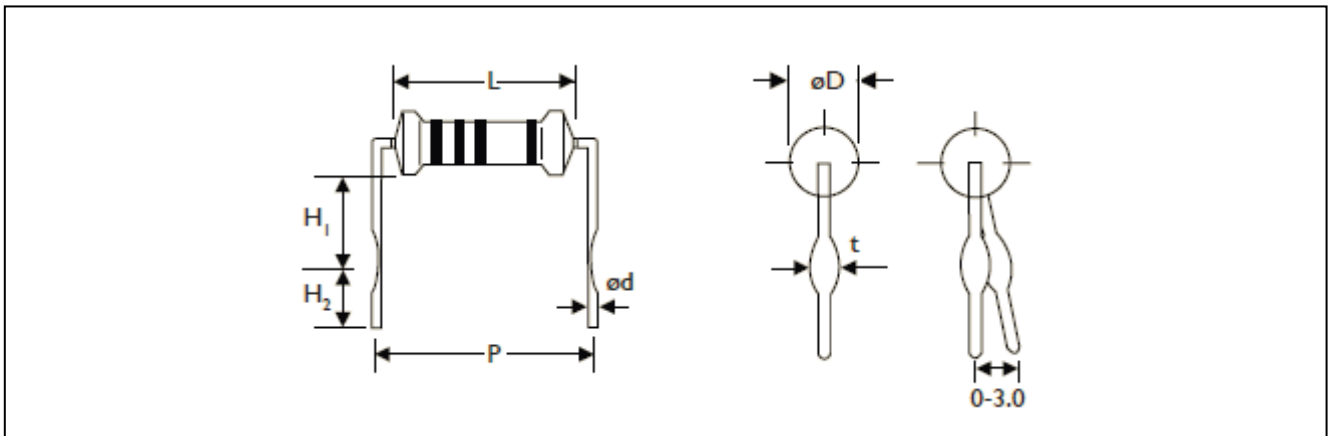

TYPE	DIMENSIONS							Unit: mm
Miniature	L	ψD	ψd	P	H1	H2	t	
MF0207	6.3 ± 0.5	2.4 ± 0.2	0.55 ± 0.05	10.0 ± 1	6.0 ± 1	5.0 ± 1	1.2 ± 0.2	

FT TYPE (Taping Pack)

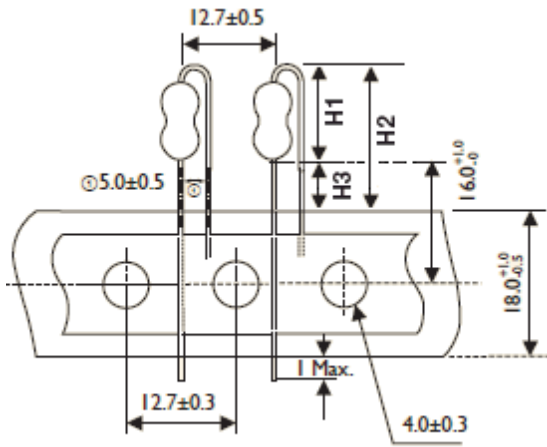

TYPE	DIMENSIONS			Unit: mm
Miniature	H1	H2	H3	
	Max.	Max.	Max.	
MF0207	10	18.5	8.5	

MT TYPE (Taping Pack)

Rated Watts : 0.4W

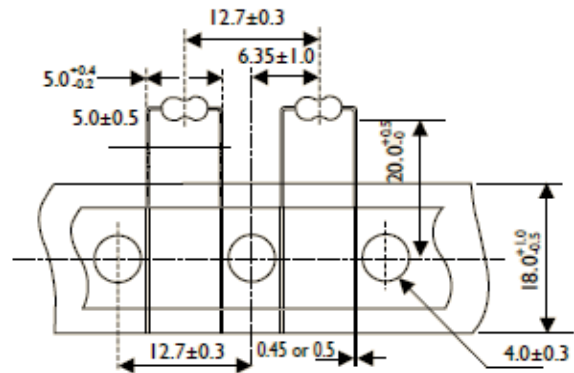

AV TYPE (Taping Pack)

PN TYPE (Taping Pack)

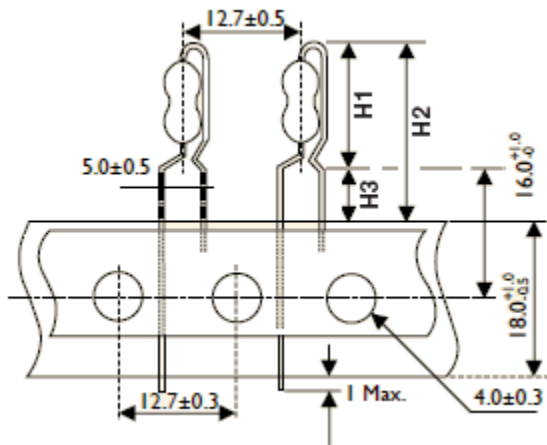

TYPE	DIMENSIONS			Unit: mm
Miniature	H1	H2	H3	
	Max.	Max.	Max.	
MF0207	13	21.5	8.5	

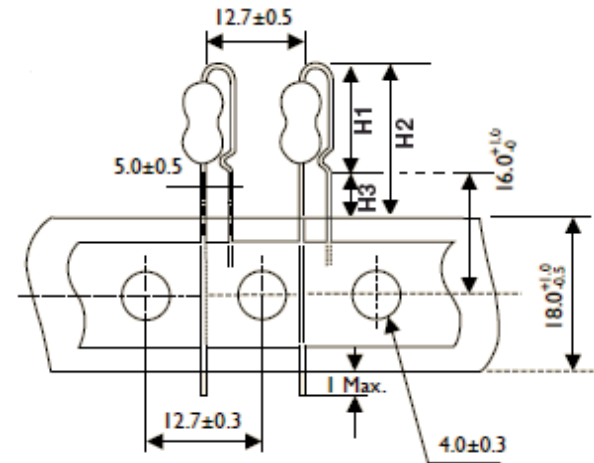

TYPE	DIMENSIONS			Unit: mm
Miniature	H1	H2	H3	
	Max.	Max.	Max.	
MF0207	11.5	20	8.5	

MARKING



COLOR	1st BAND	2nd BAND	3rd BAND	MULTIPLIER	TOLERANCE
BLACK	0	0	0	1Ω	
BROWN	1	1	1	10Ω	± 1% (F)
RED	2	2	2	100Ω	± 2% (G)
ORANGE	3	3	3	1KΩ	
YELLOW	4	4	4	10KΩ	
GREEN	5	5	5	100K	± 0.5 % (D)
BLUE	6	6	6	1MΩ	
VIOLET	7	7	7	10MΩ	
GREY	8	8	8	0.001Ω	
WHITE	9	9	9	0.0001Ω	
GOLD				0.1Ω	± 5 % (J)
SILVER				0.01Ω	

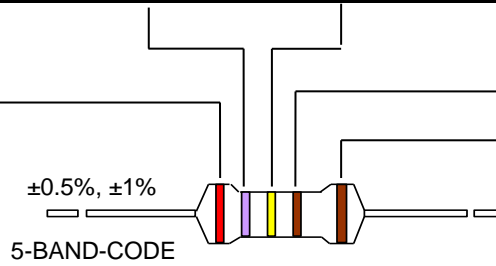

REVISION HISTORY

REVISION	DATE	CHANGE NOTIFICATION	DESCRIPTION
Version 3	Apr.2, 2024	-	- Added forming code description for part number
Version 2	Sep.5, 2023	-	- Update legal disclaimer and footer version numbers
Version 1	Mar.1, 2022		-1. Updated power rating on second page -2. Independent electrical characteristics of 0R
Version 0	Aug.2, 2021	-	- First issue of this specification

“ Yageo reserves all the rights for revising the content of this datasheet without further notification, as long as the products itse If are unchanged. Any product change will be announced by PCN.”

LEGAL DISCLAIMER

YAGEO, its distributors and agents (collectively, "YAGEO"), hereby disclaims any and all liabilities for any errors, inaccuracies or incompleteness contained in any product related information, including but not limited to product specifications, datasheets, pictures and/or graphics. YAGEO may make changes, modifications and/or improvements to product related information at any time and without notice.



YAGEO makes no representation, warranty, and/or guarantee about the fitness of its products for any particular purpose or the continuing production of any of its products. To the maximum extent permitted by law, YAGEO disclaims (i) any and all liability arising out of the application or use of any YAGEO product, (ii) any and all liability, including without limitation special, consequential or incidental damages, and (iii) any and all implied warranties, including warranties of fitness for a particular purpose, non-infringement and merchantability.

YAGEO products are designed for general purpose applications under normal operation and usage conditions. Please contact YAGEO for the applications listed below which require especially high reliability for the prevention of defects which might directly cause damage to the third party's life, body or property: Aerospace equipment (artificial satellite, rocket, etc.), Atomic energy-related equipment, Aviation equipment, Disaster prevention equipment, crime prevention equipment, Electric heating apparatus, burning equipment, Highly public information network equipment, data-processing equipment, Medical devices, Military equipment, Power generation control equipment, Safety equipment, Traffic signal equipment, Transportation equipment and Undersea equipment, or for any other application or use in which the failure of YAGEO products could result in personal injury or death, or serious property damage. Particularly **YAGEO Corporation and its affiliates do not recommend the use of commercial or automotive grade products for high reliability applications or manned space flight.**







Information provided here is intended to indicate product specifications only. YAGEO reserves all the rights for revising this content without further notification, as long as products are unchanged. Any product change will be announced by PCN.

Looking for pricing, stock, or lifecycle information?

Click below to explore more details on WIN SOURCE:

-  [View MF0207FTE52-3K32 on WIN SOURCE](#)
-  [Yageo Information](#)

Optimize Your Supply Chain with WIN SOURCE Solutions

-  Global Sourcing Solution
-  Obsolete Management
-  Cost Control Management
-  Shortage Management
-  Alternative Solution
-  Excess Inventory Management