



**THE DATASHEET OF
FMR0H104ZF**



Overview

FM Series Supercapacitors, also known as Electric Double-Layer Capacitors (EDLCs), are intended for high energy storage applications.

Applications

Supercapacitors have characteristics ranging from traditional capacitors and batteries. As a result, supercapacitors can be used like a secondary battery when applied in a DC circuit. These devices are best suited for use in low voltage DC hold-up applications such as embedded microprocessor systems with flash memory.

Benefits

- Rectangular case
- Wide range of temperature from -25°C to +70°C (all types except FMR) and -40°C to +85°C (FMR type)
- Maintenance free
- Maximum operating voltages of 3.5, 3.6, 5.5, and 6.5 VDC
- Highly reliable against liquid leakage
- Lead-free and RoHS compliant
- Leads can be transverse mounted

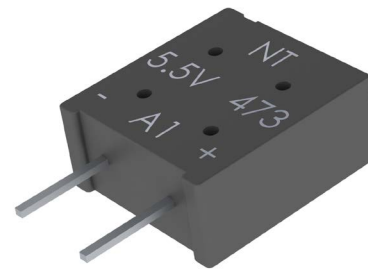

Part Number System

FM	OH	223	Z	F	TP	18
Series	Maximum Operating Voltage	Capacitance Code	Capacitance Tolerance	Environmental	Tape Type	Height (excluding lead)
FM FME FMR FMC	0V = 3.5 VDC 0H = 5.5 VDC 0J = 6.5 VDC	First two digits represent significant figures. Third digit specifies number of zeros to follow μF code.	Z = -20/+80%	F = Lead-free	TP = AMMO -L1 = Transverse mounting Blank = Bulk	18 = 18 mm Blank = Bulk

Dimensions – Millimeters

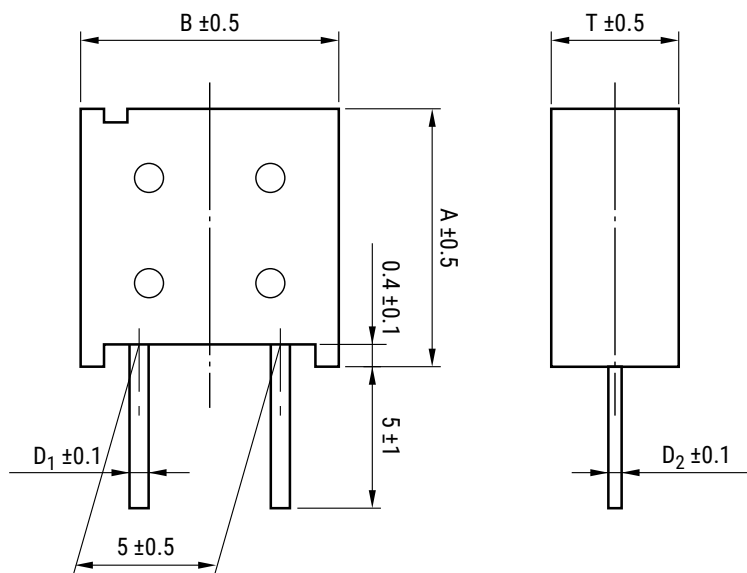

Part Number	A	B	T	D ₁	D ₂
FM0H103ZF	11.5	10.5	5.0	0.5	0.4
FM0H223ZF	11.5	10.5	5.0	0.5	0.4
FM0H473ZF	11.5	10.5	5.0	0.5	0.4
FM0H104ZF	11.5	10.5	6.5	0.5	0.4
FM0H224ZF	11.5	10.5	6.5	0.5	0.4
FM0V473ZF	11.5	10.5	5.0	0.5	0.4
FM0V104ZF	11.5	10.5	5.0	0.5	0.4
FM0V224ZF	11.5	10.5	6.5	0.5	0.4
FM0J473ZF	11.5	10.5	6.5	0.5	0.4
FME0H223ZF	11.5	10.5	5.0	0.5	0.4
FME0H473ZF	11.5	10.5	5.0	0.5	0.4
FMR0H473ZF	11.5	10.5	6.5	0.5	0.4
FMR0H104ZF	11.5	10.5	6.5	0.5	0.4
FMR0V104ZF	11.5	10.5	6.5	0.5	0.4
FMR0V334ZF	11.5	10.5	6.5	0.5	0.4
FMR0V474ZF	15.0	14.0	9.0	0.6	0.6
FMC0H473ZF	11.5	10.5	5.0	0.5	0.4
FMC0H104ZF	11.5	10.5	6.5	0.5	0.4
FMC0H334ZF	15.0	14.0	9.0	0.6	0.6

Lead Terminal Forming



Add "L1" to the end of bulk part number for transverse mounting option

Performance Characteristics

Supercapacitors should not be used for applications such as ripple absorption because of their high internal resistance (several hundred mΩ to a hundred Ω) compared to aluminum electrolytic capacitors. Thus, its main use would be similar to that of secondary battery such as power back-up in DC circuit. The following list shows the characteristics of supercapacitors as compared to aluminum electrolytic capacitors for power back-up and secondary batteries.

	Secondary Battery		Capacitor	
	NiCd	Lithium Ion	Aluminum Electrolytic	Supercapacitor
Back-up ability	-	-	-	-
Eco-hazard	Cd	-	-	-
Operating Temperature Range	-20 to +60°C	-20 to +50°C	-55 to +105°C	-40 to +85°C (FR, FT, FMR Type)
Charge Time	Few hours	Few hours	Few seconds	Few seconds
Charge/Discharge Life Time	Approximately 500 times	Approximately 500 to 1,000 times	Limitless (*1)	Limitless (*1)
Restrictions on Charge/Discharge	Yes	Yes	None	None
Flow Soldering	Not applicable	Not applicable	Applicable	Applicable
Automatic Mounting	Not applicable	Not applicable	Applicable	Applicable (FM and FC series)
Safety Risks	Leakage, explosion	Leakage, combustion, explosion, ignition	Heat-up, explosion	Gas emission (*2)

(*1) Aluminum electrolytic capacitors and supercapacitors have limited lifetime. However, when used under proper conditions, both can operate within a predetermined lifetime.

(*2) There is no harm as it is a mere leak of water vapor which transitioned from water contained in the electrolyte (diluted sulfuric acid). However, application of abnormal voltage surge exceeding maximum operating voltage may result in leakage and explosion.

Typical Applications

Intended Use (Guideline)	Power Supply (Guideline)	Application	Examples of Equipment	Series
Long time back-up	500 μA and below	CMOS microcomputer, IC for clocks	CMOS microcomputer, static RAM/DTS (digital tuning system)	FM series

Environmental Compliance

All KEMET supercapacitors are RoHS compliant.



Table 1 – Ratings & Part Number Reference

Part Number	Maximum Operating Voltage (VDC)	Nominal Capacitance		Maximum ESR at 1 kHz (Ω)	Maximum Current at 30 Minutes (mA)	Voltage Holding Characteristic Minimum (V)	Weight (g)
		Charge System (F)	Discharge System (F)				
FM0V473ZF	3.5	0.047	0.06	200	0.042	-	1.3
FMR0V104ZF	3.5	0.10	-	50	0.090	-	1.6
FM0V104ZF	3.5	0.10	0.13	100	0.090	-	1.3
FM0V224ZF	3.5	0.22	0.30	100	0.20	-	1.6
FM0H103ZF	5.5	0.01	0.014	300	0.015	4.2	1.3
FME0H223ZF	5.5	0.022	0.028	40	0.033	-	1.3
FM0H223ZF	5.5	0.022	0.028	200	0.033	4.2	1.3
FME0H473ZF	5.5	0.047	0.06	20	0.071	-	1.3
FMC0H473ZF	5.5	0.047	0.06	100	0.071	4.2	1.3
FM0H473ZF	5.5	0.047	0.06	200	0.071	4.2	1.3
FMR0H473ZF	5.5	0.047	0.062	200	0.071	4.2	1.6
FMR0H104ZF	5.5	0.10	-	50	0.15	4.2	1.6
FMR0V334ZF	3.6	-	0.33	50	0.3	-	1.6
FMR0V474ZF	3.6	-	0.47	25	0.42	-	3.5
FMC0H104ZF	5.5	0.10	0.13	50	0.15	4.2	1.6
FM0H104ZF	5.5	0.10	0.13	100	0.15	4.2	1.6
FM0H224ZF	5.5	-	0.22	100	0.33	4.2	1.6
FMC0H334ZF	5.5	-	0.33	25	0.50	4.2	3.5
FM0J473ZF	6.5	0.047	0.062	200	0.071	-	1.6

Specifications – All Types Except FMR

Item	FM 5.5 V Type, 3.5 V Type, 6.5 V Type, FMC Type	FME Type	Test Conditions (conforming to JIS C 5160-1)	
Category Temperature Range	-25°C to +70°C	-25°C to +70°C		
Maximum Operating Voltage	5.5 VDC, 3.5 VDC, 6.5 VDC	5.5 VDC		
Capacitance	Refer to Table 1	Refer to Table 1	Refer to "Measurement Conditions"	
Capacitance Allowance	+80%, -20%	+80%, -20%	Refer to "Measurement Conditions"	
ESR	Refer to Table 1	Refer to Table 1	Measured at 1 kHz, 10 mA; See also "Measurement Conditions"	
Current (30 minutes value)	Refer to Table 1	Refer to Table 1	Refer to "Measurement Conditions"	
Surge	Capacitance	> 90% of initial ratings	> 90% of initial ratings	
	ESR	≤ 120% of initial ratings	≤ 120% of initial ratings	
	Current (30 minutes value)	≤ 120% of initial ratings	≤ 120% of initial ratings	
	Appearance	No obvious abnormality	No obvious abnormality	
			Surge voltage: 4.0 V (3.5 V type) 6.3 V (5.5 V type) 7.4 V (6.5 V type) Charge: 30 seconds Discharge: 9 minutes 30 seconds Number of cycles: 1,000 Series resistance: 0.010 F 1,500 Ω 0.022 F 560 Ω 0.047 F 300 Ω 0.068 F 240 Ω 0.10 F 150 Ω 0.22 F 56 Ω 0.33 F 51 Ω Discharge resistance: 0 Ω Temperature: 70±2°C	
Characteristics in Different Temperature	Capacitance	Phase 2	≥ 50% of initial value	Conforms to 4.17 Phase 1: +25±2°C Phase 2: -25±2°C Phase 4: +25±2°C Phase 5: +70±2°C Phase 6: +25±2°C
	ESR	Phase 2	≤ 400% of initial value	
	Capacitance	Phase 3		
	ESR	Phase 3		
	Capacitance	Phase 5	≤ 200% of initial value	
	ESR	Phase 5	Satisfy initial ratings	
	Current (30 minutes value)	Phase 5	≤ 1.5 CV (mA)	
	Capacitance	Phase 6	Within ±20% of initial value	
ESR	Phase 6	Satisfy initial ratings		
Current (30 minutes value)	Phase 6	Satisfy initial ratings		
Vibration Resistance	Capacitance	Satisfy initial ratings	Satisfy initial ratings	Conforms to 4.13 Frequency: 10 to 55 Hz Testing Time: 6 hours
	ESR			
	Current (30 minutes value)			
	Appearance			
Solderability	Over 3/4 of the terminal should be covered by the new solder	Over 3/4 of the terminal should be covered by the new solder	Conforms to 4.11 Solder temp: +245±5°C Dipping time: 5±0.5 seconds 1.6 mm from the bottom should be dipped.	

Specifications – All Types Except FMR cont.

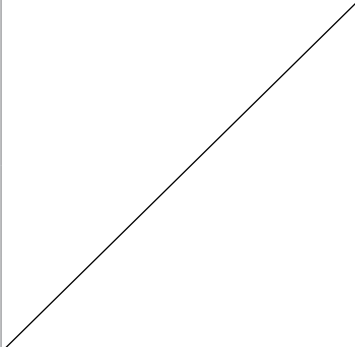
Item		FM 5.5 V Type, 3.5 V Type, 6.5 V Type, FMC Type	FME Type	Test Conditions (conforming to JIS C 5160-1)
Solder Heat Resistance	Capacitance	Satisfy initial ratings	Satisfy initial ratings	Conforms to 4.10 Solder temp: +260±10°C Dipping time: 10±1 seconds 1.6 mm from the bottom should be dipped.
	ESR			
	Current (30 minutes value)			
	Appearance			
Temperature Cycle	Capacitance	Satisfy initial ratings	Satisfy initial ratings	Conforms to 4.12 Temperature Condition: -25°C » Room temperature » +70°C » Room temperature Number of cycles: 5 cycles
	ESR			
	Current (30 minutes value)			
	Appearance			
High Temperature and High Humidity Resistance	Capacitance	Within ±20% of initial value	Within ±20% of initial value	Conforms to 4.14 Temperature: +40±2°C Relative humidity: 90 to 95% RH Testing time: 240±8 hours
	ESR	≤ 120% of initial ratings	≤ 120% of initial ratings	
	Current (30 minutes value)	≤ 120% of initial ratings	≤ 120% of initial ratings	
	Appearance	No obvious abnormality	No obvious abnormality	
High Temperature Load	Capacitance	Within ±30% of initial value	Within ±30% of initial value	Conforms to 4.15 Temperature: +70±2°C Voltage applied: Maximum operating voltage Series protection resistance: 0 Ω Testing time: 1,000 +48 (+48/-0) hours
	ESR	< 200% of initial ratings	< 200% of initial ratings	
	Current (30 minutes value)	< 200% of initial ratings	< 200% of initial ratings	
	Appearance	No obvious abnormality	No obvious abnormality	
Self Discharge Characteristics (Voltage Holding Characteristics)	5.5 V type: Voltage between terminal leads > 4.2 V Not specified 3.5 V type: Not specified 6.5 V type: Not specified			Charging condition Voltage applied: 5.0 VDC (Terminal at the case side must be negative) Series resistance: 0 Ω Charging time: 24 hours
				Storage Let stand for 24 hours in condition described below with terminals opened. Ambient temperature: < 25°C Relative humidity: < 70% RH

Specifications – FMR Type

Item		FMR Type		Test Conditions (conforming to JIS C 5160-1)
Category Temperature Range		-40°C to +85°C		
Maximum Operating Voltage		5.5 VDC, 3.5 VDC, 3.6 VDC		
Capacitance		Refer to Table 1		Refer to "Measurement Conditions"
Capacitance Allowance		+80%, -20%		Refer to "Measurement Conditions"
ESR		Refer to Table 1		Measured at 1 kHz, 10 mA; See also "Measurement Conditions"
Current (30 minutes value)		Refer to Table 1		Refer to "Measurement Conditions"
Surge	Capacitance	More than 90% of initial ratings		Surge voltage: 4.0 V (3.5 & 3.6 V type) 6.3 V (5.5 V type) Charge: 30 seconds Discharge: 9 minutes 30 seconds Number of cycles: 1,000 Series resistance: 0.047 F 300 Ω 0.10 F 150 Ω 0.33 F 56 Ω 0.47 F 30 Ω Discharge resistance: 0 Ω Temperature: 85±2°C
	ESR	Not to exceed 120% of initial ratings		
	Current (30 minutes value)	Not to exceed 120% of initial ratings		
	Appearance	No obvious abnormality		
Characteristics in Different Temperature	Capacitance	Phase 2	50% higher than initial value	Conforms to 4.17 Phase 1: +25±2°C Phase 2: -25 ±2°C Phase 3: -40 ±2°C Phase 4: +25 ±2°C Phase 5: +85 ±2°C Phase 6: +25 ±2°C
	ESR		400% or less than initial value	
	Capacitance	Phase 3	30% or higher than initial value	
	ESR		700% or less than initial value	
	Capacitance	Phase 5	200% or less than initial value	
	ESR		Satisfy initial ratings	
	Current (30 minutes value)		1.5 CV (mA) or below	
	Capacitance	Phase 6	Within ±20% of initial value	
	ESR		Satisfy initial ratings	
	Current (30 minutes value)		Satisfy initial ratings	
Lead Strength (tensile)		No terminal damage		Conforms to 4.9
Vibration Resistance	Capacitance	Satisfy initial ratings		Conforms to 4.13 Frequency: 10 to 55 Hz Testing Time: 6 hours
	ESR			
	Current (30 minutes value)			
	Appearance	No obvious abnormality		
Solderability		Over 3/4 of the terminal should be covered by the new solder		Conforms to 4.11 Solder temp: +245 ±5°C Dipping time: 5±0.5 seconds 1.6 mm from the bottom should be dipped.
Solder Heat Resistance	Capacitance	Satisfy initial ratings		Conforms to 4.10 Solder temp: +260 ±10°C Dipping time: 10±1 seconds 1.6 mm from the bottom should be dipped.
	ESR			
	Current (30 minutes value)			
	Appearance	No obvious abnormality		
Temperature Cycle	Capacitance	Satisfy initial ratings		Conforms to 4.12 Temperature Condition: -40°C » Room temperature » +85°C » Room temperature Number of cycles: 5 cycles
	ESR			
	Current (30 minutes value)			
	Appearance	No obvious abnormality		

Specifications – FMR Type cont.

Item		FMR Type	Test Conditions (conforming to JIS C 5160-1)
High Temperature and High Humidity Resistance	Capacitance	Within $\pm 20\%$ of initial value	Conforms to 4.14 Temperature: $+40 \pm 2^\circ\text{C}$ Relative humidity: 90 to 95% RH Testing time: 240 ± 8 hours
	ESR	Not to exceed 120% of initial ratings	
	Current (30 minutes value)	Not to exceed 120% of initial ratings	
	Appearance	No obvious abnormality	
High Temperature Load	Capacitance	Within $\pm 30\%$ of initial value	Conforms to 4.15 Temperature: $+85 \pm 2^\circ\text{C}$ Voltage applied: Maximum operating voltage Series protection resistance: 0Ω Testing time: 1,000 $+48$ ($+48/-0$) hours
	ESR	Below 200% of initial ratings	
	Current (30 minutes value)	Below 200% of initial ratings	
	Appearance	No obvious abnormality	
Self Discharge Characteristics (Voltage Holding Characteristics)	5.5 V type:	Voltage between terminal leads higher than 4.2 V	Charging condition Voltage applied: 5.0 VDC (Terminal at the case side must be negative) Series resistance: 0Ω Charging time: 24 hours
	3.5 V type: 3.6 V type:	Not specified	Storage Let stand for 24 hours in condition described below with terminals opened. Ambient temperature: Lower than 25°C Relative humidity: Lower than 70% RH

Construction

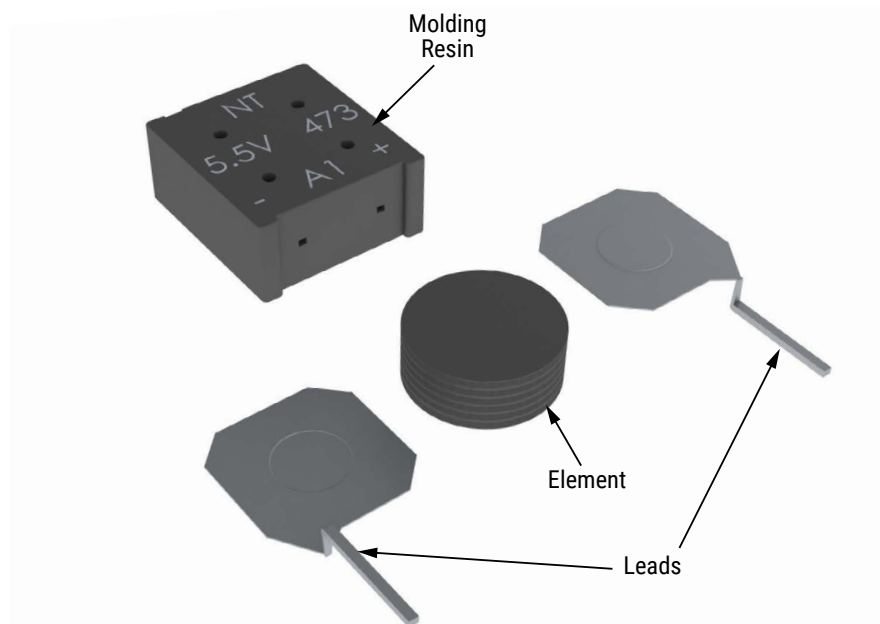

Marking

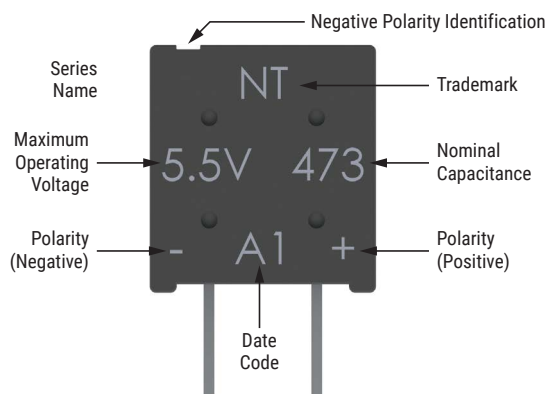

Packaging Quantities

Part Number	Bulk Quantity per Box Straight Lead	Bulk Quantity per Box L1 Lead Option	Ammo Pack Quantity
FM0H103ZF	1,000 pieces	1,000 pieces	1,000 pieces
FM0H223ZF	1,000 pieces	1,000 pieces	1,000 pieces
FM0H473ZF	1,000 pieces	1,000 pieces	1,000 pieces
FM0H104ZF	1,000 pieces	800 pieces	1,000 pieces
FM0H224ZF	1,000 pieces	800 pieces	1,000 pieces
FM0V473ZF	1,000 pieces	1,000 pieces	1,000 pieces
FM0V104ZF	1,000 pieces	1,000 pieces	1,000 pieces
FM0V224ZF	1,000 pieces	800 pieces	1,000 pieces
FM0J473ZF	1,000 pieces	800 pieces	1,000 pieces
FME0H223ZF	1,000 pieces	1,000 pieces	1,000 pieces
FME0H473ZF	1,000 pieces	1,000 pieces	1,000 pieces
FMR0H473ZF	1,000 pieces	1,000 pieces	1,000 pieces
FMR0H104ZF	1,000 pieces	1,000 pieces	1,000 pieces
FMR0V104ZF	1,000 pieces	800 pieces	1,000 pieces
FMR0V334ZF	1,000 pieces	800 pieces	1,000 pieces
FMR0V474ZF	400 pieces	300 pieces	400 pieces
FMC0H473ZF	1,000 pieces	1,000 pieces	1,000 pieces
FMC0H104ZF	1,000 pieces	1,000 pieces	1,000 pieces
FMC0H334ZF	400 pieces	300 pieces	400 pieces

Ammo Pack Taping Format (Except FMC0H334ZFTP, FMR0V474ZFTP)

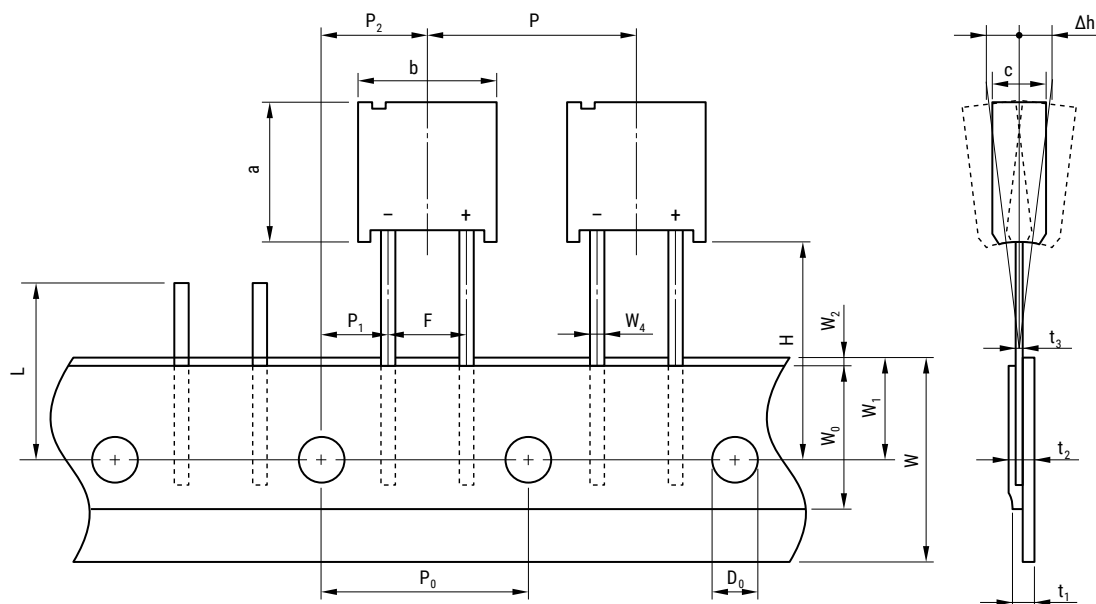

Ammo Pack Taping Specifications (Except FMC0H334ZFTP, FMR0V474ZFTP)

Item	Symbol	Dimensions (mm)
Component Height	a	11.5±0.5
Component Width	b	10.5±0.5
Component Thickness	c	Refer to "Dimensions" table
Lead-Wire Width	W_4	0.5±0.1
Lead-Wire Thickness	t_3	0.4±0.1
Component Pitch	P	12.7±1.0
Sprocket Hole Pitch	P_0	12.7±0.3
Sprocket Hole Center to Lead Center	P_1	3.85±0.7
Sprocket Hole Center to Component Center	P_2	6.35±0.7
Lead Spacing	F	5.0±0.5
Component Alignment (side/side)	Δh	2.0 Maximum
Carrier Tape Width	W	18.0+1.0/-0.5
Hold-Down Tape Width	W_0	12.5 Minimum
Sprocket Hole Position	W_1	9.0±0.5
Hold-Down Tape Position	W_2	3.0 Maximum
Height to Seating Plane (lead length)	H	16.0±0.5/18.0±0.5
Sprocket Hole Diameter	D_0	∅ 4.0±0.2
Carrier Tape Thickness	t_1	0.7±0.2
Total Thickness (Carrier Tape, Hold-Down Tape and Lead)	t_2	1.5 Maximum
Cut Out Length	L	11.0 Maximum

Ammo Pack Taping Format (FMC0H334ZFTP, FMR0V474ZFTP)

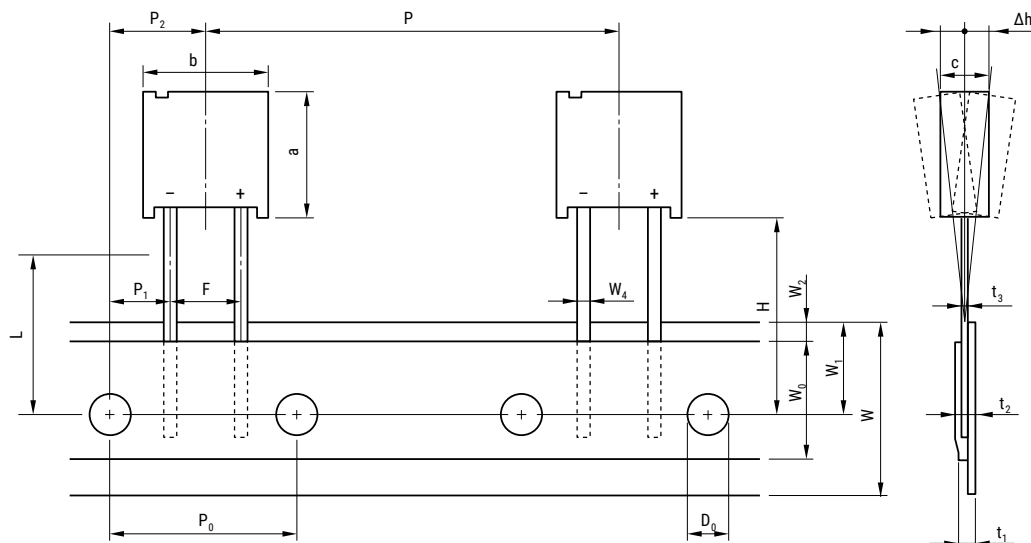

Ammo Pack Taping Specifications (FMC0H334ZFTP, FMR0V474ZFTP)

Item	Symbol	Dimensions (mm)
Component Height	a	15.0±0.5
Component Width	b	14.0±0.5
Component Thickness	c	9.0±0.5
Lead-Wire Width	W_4	0.6±0.1
Lead-Wire Thickness	t_3	0.6±0.1
Component Pitch	P	25.4±1.0
Sprocket Hole Pitch	P_0	12.7±0.3
Sprocket Hole Center to Lead Center	P_1	3.85±0.7
Sprocket Hole Center to Component Center	P_2	6.35±0.7
Lead Spacing	F	5.0±0.5
Component Alignment (side/side)	Δh	2.0 Maximum
Carrier Tape Width	W	18.0+1.0/-0.5
Hold-Down Tape Width	W_0	12.5 Minimum
Sprocket Hole Position	W_1	9.0±0.5
Hold-Down Tape Position	W_2	3.0 Maximum
Height to Seating Plane (lead length)	H	16.0±0.5/18.0±0.5
Sprocket Hole Diameter	D_0	∅ 4.0±0.2
Carrier Tape Thickness	t_1	0.67±0.2
Total Thickness (Carrier Tape, Hold-Down Tape and Lead)	t_2	1.7 Maximum
Cut Out Length	L	11.0 Maximum

Measurement Conditions

Capacitance (Charge System)

Capacitance is calculated from expression (9) by measuring the charge time constant (τ) of the capacitor (C). Prior to measurement, the capacitor is discharged by shorting both pins of the device for at least 30 minutes. In addition, use the polarity indicator on the device to determine correct orientation of capacitor for charging.

$$\text{Capacitance: } C = \frac{\tau}{R_c} \text{ (F) (9)}$$

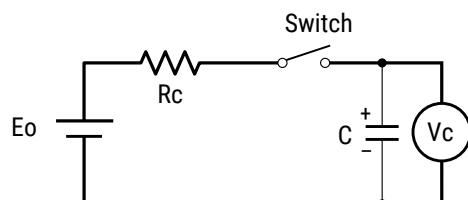

Eo: 3.0 (V) Product with maximum operating voltage of 3.5 V
 5.0 (V) Product with maximum operating voltage of 5.5 V
 6.0 (V) Product with maximum operating voltage of 6.5 V
 10.0 (V) Product with maximum operating voltage of 11 V
 12.0 (V) Product with maximum operating voltage of 12 V
 τ : Time from start of charging until Vc becomes 0.632 Eo (V)
 (seconds)
Rc: See table below (Ω).

Charge Resistor Selection Guide

Cap	FA	FE	FS	FY		FR	FM, FME FMR	FMC	FG, FGR	FGH	FT	FC, FCS	HV
				FYD	FYH								
0.010 F	-	-	-	-	-	-	5,000 Ω	-	5,000 Ω	-	-	-	-
0.022 F	1,000 Ω	-	1,000 Ω	2,000 Ω	2,000 Ω	2,000 Ω	2,000 Ω	-	2,000 Ω	-	-	Discharge	-
0.033 F	-	-	-	-	-	-	Discharge	-	-	-	-	-	-
0.047 F	1,000 Ω	1,000 Ω	1,000 Ω	2,000 Ω	1,000 Ω	1,000 Ω	2000 Ω	1,000 Ω	2,000 Ω	-	-	-	-
0.10 F	510 Ω	510 Ω	510 Ω	1,000 Ω	510 Ω	1,000 Ω	1000 Ω	1,000 Ω	1,000 Ω	Discharge	510 Ω	Discharge	-
0.22 F	200 Ω	200 Ω	200 Ω	510 Ω	510 Ω	510 Ω	0H: Discharge 0V: 1000 Ω	-	1,000 Ω	Discharge	200 Ω	Discharge	-
0.33 F	-	-	-	-	-	-	-	Discharge	-	-	-	-	-
0.47 F	100 Ω	100 Ω	100 Ω	200 Ω	200 Ω	200 Ω	-	-	1,000 Ω	Discharge	100 Ω	Discharge	-
1.0 F	51 Ω	51 Ω	100 Ω	100 Ω	100 Ω	100 Ω	-	-	510 Ω	Discharge	100 Ω	Discharge	Discharge
1.4 F	-	-	-	200 Ω	-	-	-	-	-	-	-	-	-
1.5 F	-	51 Ω	-	-	-	-	-	-	510 Ω	-	-	-	-
2.2 F	-	-	-	100 Ω	-	-	-	-	200 Ω	-	51 Ω	-	-
2.7 F	-	-	-	-	-	-	-	-	-	-	-	-	Discharge
3.3 F	-	-	-	-	-	-	-	-	-	-	51 Ω	-	-
4.7 F	-	-	-	-	-	-	-	-	100 Ω	-	-	-	Discharge
5.0 F	-	-	100 Ω	-	-	-	-	-	-	-	-	-	-
5.6 F	-	-	-	-	-	-	-	-	-	-	20 Ω	-	-
10.0 F	-	-	-	-	-	-	-	-	-	-	-	-	Discharge
22.0 F	-	-	-	-	-	-	-	-	-	-	-	-	Discharge
50.0 F	-	-	-	-	-	-	-	-	-	-	-	-	Discharge
100.0 F	-	-	-	-	-	-	-	-	-	-	-	-	Discharge
200.0 F	-	-	-	-	-	-	-	-	-	-	-	-	Discharge

*Capacitance values according to the constant current discharge method.

*HV Series capacitance is measured by discharge system.

Measurement Conditions cont.

Capacitance (Discharge System)

As shown in the diagram below, charging is performed for a duration of 30 minutes once the voltage of the capacitor terminal reaches 5.5 V. Then, use a constant current load device and measure the time for the terminal voltage to drop from 3.0 to 2.5 V upon discharge at 0.22 mA per 0.22 F, for example, and calculate the static capacitance according to the equation shown below.

Note: The current value is 1 mA discharged per 1 F.

$$C = \frac{I \times (T_2 - T_1)}{V_1 - V_2} \text{ (F)}$$

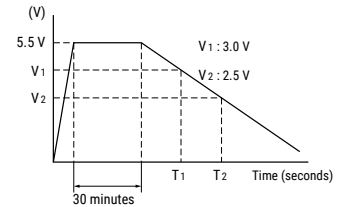
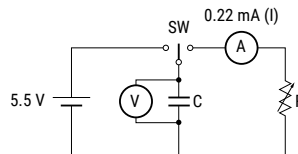

Capacitance (Discharge System – 3.5 V, 3.6 V)

As shown in the diagram below, charging is performed for a duration of 30 minutes once the voltage of the capacitor terminal reaches 3.5 V (3.6 V). Then, use a constant current load device and measure the time for the terminal voltage to drop from 1.8 to 1.5 V upon discharge at 1.0 mA per 1.0 F, for example, and calculate the static capacitance according to the equation shown below.

$$C = \frac{I \times (T_2 - T_1)}{V_1 - V_2} \text{ (F)}$$

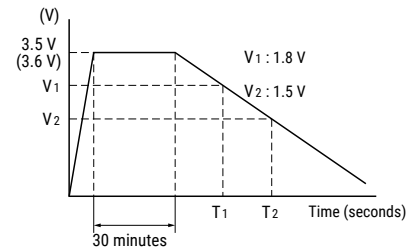
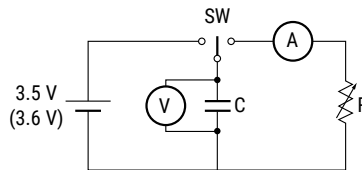

Capacitance (Discharge System – HV Series)

As shown in the diagram below, charging is performed for a duration of 30 minutes once the voltage of the capacitor terminal reaches maximum operating voltage. Then, use a constant current load device and measure the time for the terminal voltage to drop from 2.0 to 1.5 V upon discharge at 1.0 mA per 1.0 F, and calculate the static capacitance according to the equation shown below.

$$C = \frac{I \times (T_2 - T_1)}{V_1 - V_2} \text{ (F)}$$

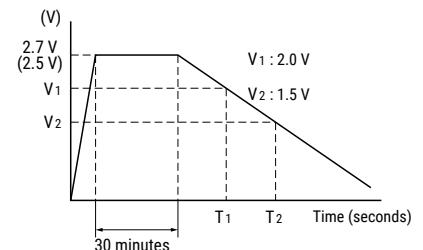
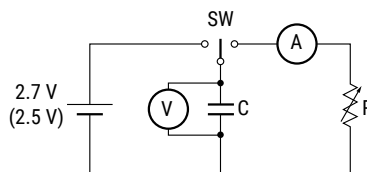

Measurement Conditions cont.

Equivalent Series Resistance (ESR)

ESR shall be calculated from the equation below.

$$ESR = \frac{V_C}{0.01} (\Omega)$$

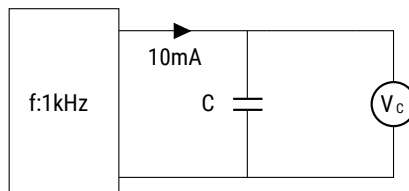

Current (at 30 minutes after charging)

Current shall be calculated from the equation below. Prior to measurement, both lead terminals must be short-circuited for a minimum of 30 minutes. The lead terminal connected to the metal can case is connected to the negative side of the power supply.

- E_o: 2.5 VDC (HV Series 50 F)
 2.7 VDC (HV Series except 50 F)
 3.0 VDC (3.5 V type)
 3.6 VDC (3.6 V type)
 5.0 VDC (5.5 V type)
 6.0 VDC (6.5 V type)
 10.0 VDC (11 V type)
 12.0 VDC (12 V type)

$$\text{Current} = \frac{V_R}{R_C} (\text{A})$$

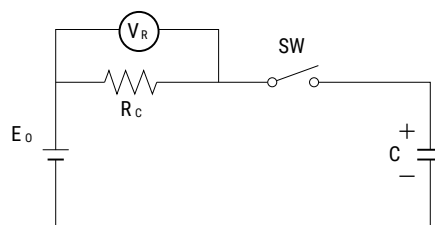

- R_c: 1,000 Ω (0.01 F, 0.022 F, 0.047 F)
 100 Ω (0.10 F, 0.22 F, 0.33 F, 0.47 F)
 10 Ω (1.0 F, 1.4 F, 1.5 F, 2.2 F, 3.3 F, 4.7 F, 5.6 F)
 2.2 Ω (HV Series)
 However, FS Series 11 V type and 12 V type
 100 Ω 0.47 F, 1.0 F
 10 Ω 5.0 F

Self-Discharge Characteristic (0H – 5.5 V Products)

The self-discharge characteristic is measured by charging a voltage of 5.0 VDC (charge protection resistance: 0 Ω) according to the capacitor polarity for 24 hours, then releasing between the pins for 24 hours and measuring the pin-to-pin voltage. The test should be carried out in an environment with an ambient temperature of 25° C or below and relative humidity of 70% RH or below. The soldering is checked.

4. Dismantling

There is a small amount of electrolyte stored within the capacitor. Do not attempt to dismantle as direct skin contact with the electrolyte will cause burning. This product should be treated as industrial waste and not is not to be disposed of by fire.

Notes on Using Supercapacitors or Electric Double-Layer Capacitors (EDLCs)

1. Circuitry Design

1.1 Useful life

The FC Series Supercapacitor (EDLC) uses an electrolyte in a sealed container. Water in the electrolyte can evaporate while in use over long periods of time at high temperatures, thus reducing electrostatic capacity which in turn will create greater internal resistance. The characteristics of the supercapacitor can vary greatly depending on the environment in which it is used. Basic breakdown mode is an open mode due to increased internal resistance.

1.2 Fail rate in the field

Based on field data, the fail rate is calculated at approximately 0.006 Fit. We estimate that unreported failures are ten times this amount. Therefore, we assume that the fail rate is below 0.06 Fit.

1.3 Exceeding maximum usable voltage

Performance may be compromised and in some cases leakage or damage may occur if applied voltage exceeds maximum working voltage.

1.4 Use of capacitor as a smoothing capacitor (ripple absorption)

As supercapacitors contain a high level of internal resistance, they are not recommended for use as smoothing capacitors in electrical circuits. Performance may be compromised and, in some cases, leakage or damage may occur if a supercapacitor is used in ripple absorption.

1.5 Series connections

As applied voltage balance to each supercapacitor is lost when used in series connection, excess voltage may be applied to some supercapacitors, which will not only negatively affect its performance but may also cause leakage and/or damage. Allow ample margin for maximum voltage or attach a circuit for applying equal voltage to each supercapacitor (partial pressure resistor/voltage divider) when using supercapacitors in series connection. Also, arrange supercapacitors so that the temperature between each capacitor will not vary.

1.6 Case Polarity

The supercapacitor is manufactured so that the terminal on the outer case is negative (-). Align the (-) symbol during use. Even though discharging has been carried out prior to shipping, any residual electrical charge may negatively affect other parts.

1.7 Use next to heat emitters

Useful life of the supercapacitor will be significantly affected if used near heat emitting items (coils, power transistors and posistors, etc.) where the supercapacitor itself may become heated.

1.8 Usage environment

This device cannot be used in any acidic, alkaline or similar type of environment.

Notes on Using Supercapacitors or Electric Double-Layer Capacitors (EDLCs) cont.

2. Mounting

2.1 Mounting onto a reflow furnace

Except for the FC series, it is not possible to mount this capacitor onto an IR / VPS reflow furnace. Do not immerse the capacitor into a soldering dip tank.

2.2 Flow soldering conditions

Keep solder under 260°C and soldering time to within 10 seconds when using the flow automatic soldering method. (Except for the FC and HV series)

2.3 Installation using a soldering iron

Care must be taken to prevent the soldering iron from touching other parts when soldering. Keep the tip of the soldering iron under 400°C and soldering time to within 3 seconds. Always make sure that the temperature of the tip is controlled. Internal capacitor resistance is likely to increase if the terminals are overheated.

2.4 Lead terminal processing

Do not attempt to bend or polish the capacitor terminals with sand paper, etc. Soldering may not be possible if the metallic plating is removed from the top of the terminals.

2.5 Cleaning, Coating, and Potting

Except for the FM series, cleaning, coating and potting must not be carried out. Consult KEMET if this type of procedure is necessary. Terminals should be dried at less than the maximum operating temperature after cleaning.

3. Storage

3.1 Temperature and humidity

Make sure that the supercapacitor is stored according to the following conditions: Temperature: 5 – 35°C (Standard 25°C), Humidity: 20 – 70% (Standard: 50%). Do not allow the build up of condensation through sudden temperature change.

3.2 Environment conditions

Make sure there are no corrosive gasses such as sulfur dioxide, as penetration of the lead terminals is possible. Always store this item in an area with low dust and dirt levels. Make sure that the packaging will not be deformed through heavy loading, movement and/or knocks. Keep out of direct sunlight and away from radiation, static electricity and magnetic fields.

3.3 Maximum storage period

This item may be stored up to one year from the date of delivery if stored at the conditions stated above.

Dismantling

There is a small amount of electrolyte stored within the capacitor. Do not attempt to dismantle as direct skin contact with the electrolyte will cause burning. This product should be treated as industrial waste and not be disposed of by fire.

KEMET Electronics Corporation Sales Offices

For a complete list of our global sales offices, please visit www.kemet.com/sales.

Disclaimer

YAGEO Corporation and its affiliates do not recommend the use of commercial or automotive grade products for high reliability applications or manned space flight.

All product specifications, statements, information and data (collectively, the "Information") in this datasheet are subject to change. The customer is responsible for checking and verifying the extent to which the Information contained in this publication is applicable to an order at the time the order is placed. All Information given herein is believed to be accurate and reliable, but it is presented without guarantee, warranty, or responsibility of any kind, expressed or implied.

Statements of suitability for certain applications are based on KEMET Electronics Corporation's ("KEMET") knowledge of typical operating conditions for such applications, but are not intended to constitute – and KEMET specifically disclaims – any warranty concerning suitability for a specific customer application or use. The Information is intended for use only by customers who have the requisite experience and capability to determine the correct products for their application. Any technical advice inferred from this Information or otherwise provided by KEMET with reference to the use of KEMET's products is given gratis, and KEMET assumes no obligation or liability for the advice given or results obtained.

Although KEMET designs and manufactures its products to the most stringent quality and safety standards, given the current state of the art, isolated component failures may still occur. Accordingly, customer applications which require a high degree of reliability or safety should employ suitable designs or other safeguards (such as installation of protective circuitry or redundancies) in order to ensure that the failure of an electrical component does not result in a risk of personal injury or property damage.

Although all product-related warnings, cautions and notes must be observed, the customer should not assume that all safety measures are indicated or that other measures may not be required.

When providing KEMET products and technologies contained herein to other countries, the customer must abide by the procedures and provisions stipulated in all applicable export laws and regulations, including without limitation the International Traffic in Arms Regulations (ITAR), the US Export Administration Regulations (EAR) and the Japan Foreign Exchange and Foreign Trade Act.

KEMET is a registered trademark of KEMET Electronics Corporation.

Looking for pricing, stock, or lifecycle information?

Click below to explore more details on WIN SOURCE:

 [View FMR0H104ZF on WIN SOURCE](#)

 [Kemet Information](#)

Optimize Your Supply Chain with WIN SOURCE Solutions

-  Global Sourcing Solution
-  Obsolete Management
-  Cost Control Management
-  Shortage Management
-  Alternative Solution
-  Excess Inventory Management