

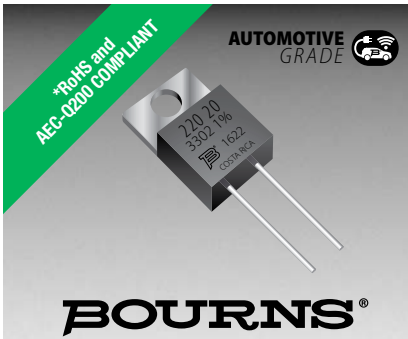

**THE DATASHEET OF
PWR220T-20-2000F**





Features

- TO-220 housing
- Low inductance
- Resistor electrically isolated from the backplate
- High power rating
- AEC-Q200 compliant
- RoHS compliant*

PWR220T-20 Series Power Resistor

General Information

Bourns® PWR220T-20 Series is a TO-220 DPAK style power resistor. Manufactured using thick film on alumina ceramic technology, it is used in current measurement, snubber, bleeder and discharge circuits.

Electrical & Thermal Characteristics

Parameter	Value(s)
Resistance (See Popular Resistance Values table)	0.02 Ω to 130 KΩ
Power Rating @ 25 °C Case Temperature	20 W
Tolerance	±1 %**, ±5 %
TCR 0.02 Ω < R < 130.0K Ω	±100 PPM/°C
Thermal Resistance - Rthj	6.5 °C/W
Inductance	0.1 μH maximum
Operating Voltage	√P*R with a maximum of 250 V
Dielectric Strength	2 KV AC
Insulation Resistance	10 GΩ
Operating Temperature	-55 °C to 155 °C

** Available for most values. Check Popular Resistance Values table.

Reliability Characteristics

Parameter	Specification
Short Term Overload (2x Pr for R < 2 Ω, 1.6 x Pr for R ≥ 2 Ω, V < 1.5 x Operating Voltage)	ΔR ±0.25 %
Load Life (1000 hours at rated power)	ΔR ±1.0 %
Thermal Shock (-55 °C to 155 °C, 5 cycles)	ΔR ±0.5 %
Resistance to Soldering Heat (10 seconds at 270 °C)	ΔR ±0.5 %
Vibration (20 G 10-2000 Hz .06" D.A.)	ΔR ±0.25 %
Terminal Strength (MIL-STD-202, Method 211 Test A1)	ΔR ±0.2 %
Shock (Saw Tooth: 100 g/6 ms)	ΔR ±0.5 %
Humidity (Steady State) 1000 hrs. 85 °C/85 % RH	ΔR ±0.5 %
High Temperature Exposure (100 hrs - 40 % Pr @ +125 °C)	ΔR ±0.5 %

Material Characteristics

Resistor Thick film
 Substrate Alumina (AL203)
 Housing Epoxy
 Pins Tinned Copper (Sn/Cu)
 Flammability Conforms to UL-94V0

Packaging

..... 50 pcs./tube

Additional Information

Click these links for more information:



Popular Resistance Values

Code	Resistance Value	Code	Resistance Value
R020	0.02 Ω***	1000	100 Ω
R025	0.025 Ω***	1200	120 Ω
R030	0.03 Ω***	1500	150 Ω
R033	0.033 Ω***	2000	200 Ω
R040	0.04 Ω***	2500	250 Ω
R050	0.05 Ω***	3000	300 Ω
R075	0.075 Ω***	3300	330 Ω
R100	0.1 Ω	4000	400 Ω
R150	0.15 Ω	4700	470 Ω
R200	0.2 Ω	5000	500 Ω
R250	0.25 Ω	5600	560 Ω
R300	0.3 Ω	7500	750 Ω
R330	0.33 Ω	1001	1.0 KΩ
R400	0.4 Ω	1501	1.5 KΩ
R500	0.5 Ω	2001	2.0 KΩ
R750	0.75 Ω	2501	2.5 KΩ
1R00	1 Ω	3001	3.0 KΩ
1R50	1.5 Ω	3301	3.3 KΩ
2R00	2 Ω	4001	4.0 KΩ
2R50	2.5 Ω	5001	5.0 KΩ
3R00	3 Ω	7501	7.5 KΩ
3R30	3.3 Ω	1002	10 KΩ
4R00	4 Ω	1502	15 KΩ
5R00	5 Ω	2002	20 KΩ
7R50	7.5 Ω	2502	25 KΩ
8R00	8 Ω	3002	30 KΩ
10R0	10 Ω	3302	33 KΩ
12R0	12 Ω	4002	40 KΩ
15R0	15 Ω	4702	47 KΩ
20R0	20 Ω	5002	50 KΩ
25R0	25 Ω	5602	56 KΩ
27R0	27 Ω	6802	68 KΩ
30R0	30 Ω	7502	75 KΩ
33R0	33 Ω	8202	82 KΩ
40R0	40 Ω	1003	100 KΩ
47R0	47 Ω	1153	115 KΩ
50R0	50 Ω	1203	120 KΩ
56R0	56 Ω	1253	125 KΩ
75R0	75 Ω	1303	130 KΩ

*** 5 % Tolerance



WARNING Cancer and Reproductive Harm
www.P65Warnings.ca.gov

*RoHS Directive 2015/863, Mar 31, 2015 and Annex.
 Specifications are subject to change without notice.
 Users should verify actual device performance in their specific applications.
 The products described herein and this document are subject to specific legal disclaimers as set forth on the last page of this document, and at www.bourns.com/docs/legal/disclaimer.pdf.

PWR220T-20 Series Power Resistor



Product Dimensions

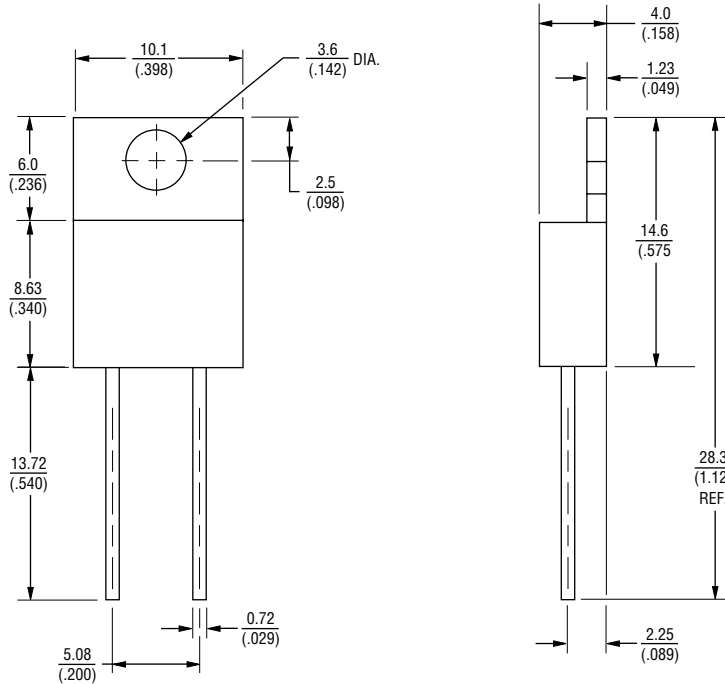

DIMENSIONS: $\frac{\text{MM}}{\text{(INCHES)}}$

TOLERANCE: $\pm \frac{0.38}{(0.015)}$ UNLESS OTHERWISE NOTED

Pulse Power Rating

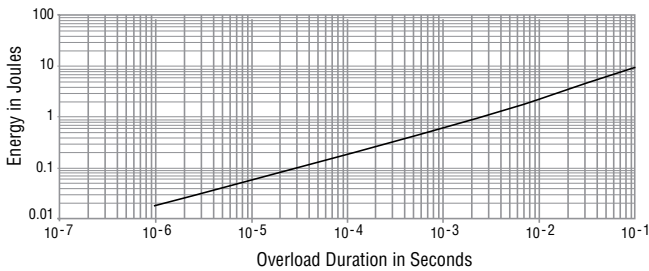

The energy absorbed by the resistor expressed in Joules can be calculated by multiplying the peak power of the pulse in watts times the length of the pulse in seconds.

The energy should not exceed the limits shown in the graph. The overload voltage should not exceed 1.5 times the maximum operating voltage.

Power Derating Curve

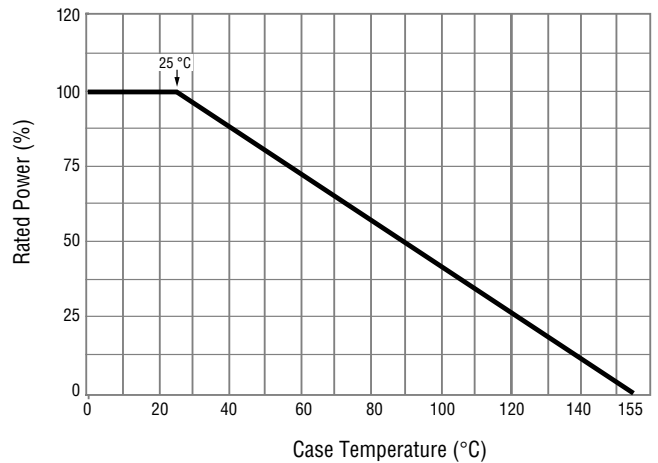

Specifications are subject to change without notice.

Users should verify actual device performance in their specific applications.

The products described herein and this document are subject to specific legal disclaimers as set forth on the last page of this document, and at www.bourns.com/docs/legal/disclaimer.pdf.

PWR220T-20 Series Power Resistor



Soldering Profile

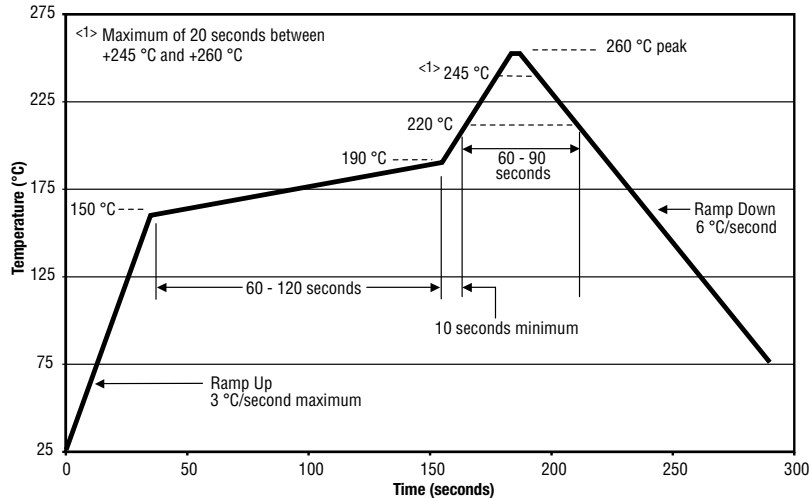

Power dissipation is 2.8 W at an ambient temperature of 25 °C when mounted on a double-sided copper board using FR4 standard, 70 μm of copper, 39 x 30 x 1.6 mm.

Typical Part Marking

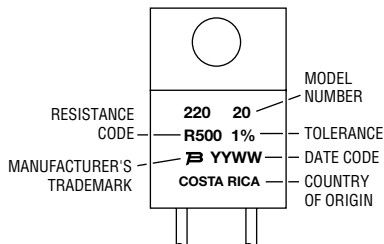

How to Order

PWR 220 T - 20 - 10R0 F

Model _____
PWR = Power Resistor

Package _____
220 = TO-220 Style

Pin Style _____
T = Through-hole

Power _____
20 = 20 W

Resistance Value _____
<100 ohms ... "R" represents decimal point
(examples: 7R50 = 7.5 Ω; R500 = 0.5 Ω)

≥100 ohms.... First three digits are significant, fourth digit represents number of zeros to follow
(examples: 2000 = 200 ohms; 3002 = 30K ohms)

Absolute Tolerance _____
J = 5 %
F = 1 %



Asia-Pacific: Tel: +886-2 2562-4117 • Email: asiacus@bourns.com

EMEA: Tel: +36 88 885 877 • Email: eurocus@bourns.com

The Americas: Tel: +1-951 781-5500 • Email: americus@bourns.com

www.bourns.com

REV. 07/21

Specifications are subject to change without notice.

Users should verify actual device performance in their specific applications.

The products described herein and this document are subject to specific legal disclaimers as set forth on the last page of this document, and at www.bourns.com/docs/legal/disclaimer.pdf.

This legal disclaimer applies to purchasers and users of Bourns® products manufactured by or on behalf of Bourns, Inc. and its affiliates (collectively, "Bourns").

Unless otherwise expressly indicated in writing, Bourns® products and data sheets relating thereto are subject to change without notice. Users should check for and obtain the latest relevant information and verify that such information is current and complete before placing orders for Bourns® products.

The characteristics and parameters of a Bourns® product set forth in its data sheet are based on laboratory conditions, and statements regarding the suitability of products for certain types of applications are based on Bourns' knowledge of typical requirements in generic applications. The characteristics and parameters of a Bourns® product in a user application may vary from the data sheet characteristics and parameters due to (i) the combination of the Bourns® product with other components in the user's application, or (ii) the environment of the user application itself. The characteristics and parameters of a Bourns® product also can and do vary in different applications and actual performance may vary over time. Users should always verify the actual performance of the Bourns® product in their specific devices and applications, and make their own independent judgments regarding the amount of additional test margin to design into their device or application to compensate for differences between laboratory and real world conditions.

Unless Bourns has explicitly designated an individual Bourns® product as meeting the requirements of a particular industry standard (e.g., ISO/TS 16949) or a particular qualification (e.g., UL listed or recognized), Bourns is not responsible for any failure of an individual Bourns® product to meet the requirements of such industry standard or particular qualification. Users of Bourns® products are responsible for ensuring compliance with safety-related requirements and standards applicable to their devices or applications.

Bourns® products are not recommended, authorized or intended for use in nuclear, lifesaving, life-critical or life-sustaining applications, nor in any other applications where failure or malfunction may result in personal injury, death, or severe property or environmental damage. Unless expressly and specifically approved in writing by two authorized Bourns representatives on a case-by-case basis, use of any Bourns® products in such unauthorized applications might not be safe and thus is at the user's sole risk. Life-critical applications include devices identified by the U.S. Food and Drug Administration as Class III devices and generally equivalent classifications outside of the United States.

Bourns expressly identifies those Bourns® standard products that are suitable for use in automotive applications on such products' data sheets in the section entitled "Applications." Unless expressly and specifically approved in writing by two authorized Bourns representatives on a case-by-case basis, use of any other Bourns® standard products in an automotive application might not be safe and thus is not recommended, authorized or intended and is at the user's sole risk. If Bourns expressly identifies a sub-category of automotive application in the data sheet for its standard products (such as infotainment or lighting), such identification means that Bourns has reviewed its standard product and has determined that if such Bourns® standard product is considered for potential use in automotive applications, it should only be used in such sub-category of automotive applications. Any reference to Bourns® standard product in the data sheet as compliant with the AEC-Q standard or "automotive grade" does not by itself mean that Bourns has approved such product for use in an automotive application.

Bourns® standard products are not tested to comply with United States Federal Aviation Administration standards generally or any other generally equivalent governmental organization standard applicable to products designed or manufactured for use in aircraft or space applications. Bourns expressly identifies Bourns® standard products that are suitable for use in aircraft or space applications on such products' data sheets in the section entitled "Applications." Unless expressly and specifically approved in writing by two authorized Bourns representatives on a case-by-case basis, use of any other Bourns® standard product in an aircraft or space application might not be safe and thus is not recommended, authorized or intended and is at the user's sole risk.

The use and level of testing applicable to Bourns® custom products shall be negotiated on a case-by-case basis by Bourns and the user for which such Bourns® custom products are specially designed. Absent a written agreement between Bourns and the user regarding the use and level of such testing, the above provisions applicable to Bourns® standard products shall also apply to such Bourns® custom products.

Users shall not sell, transfer, export or re-export any Bourns® products or technology for use in activities which involve the design, development, production, use or stockpiling of nuclear, chemical or biological weapons or missiles, nor shall they use Bourns® products or technology in any facility which engages in activities relating to such devices. The foregoing restrictions apply to all uses and applications that violate national or international prohibitions, including embargos or international regulations. Further, Bourns® products and Bourns technology and technical data may not under any circumstance be exported or re-exported to countries subject to international sanctions or embargoes. Bourns® products may not, without prior authorization from Bourns and/or the U.S. Government, be resold, transferred, or re-exported to any party not eligible to receive U.S. commodities, software, and technical data.

To the maximum extent permitted by applicable law, Bourns disclaims (i) any and all liability for special, punitive, consequential, incidental or indirect damages or lost revenues or lost profits, and (ii) any and all implied warranties, including implied warranties of fitness for particular purpose, non-infringement and merchantability.



For your convenience, copies of this Legal Disclaimer Notice with German, Spanish, Japanese, Traditional Chinese and Simplified Chinese bilingual versions are available at:

Web Page: <http://www.bourns.com/legal/disclaimers-terms-and-policies>

PDF: <http://www.bourns.com/docs/Legal/disclaimer.pdf>

Looking for pricing, stock, or lifecycle information?

Click below to explore more details on WIN SOURCE:

-  [View PWR220T-20-2000F on WIN SOURCE](#)
-  [Bourns Inc. Information](#)

Optimize Your Supply Chain with WIN SOURCE Solutions

-  Global Sourcing Solution
-  Obsolete Management
-  Cost Control Management
-  Shortage Management
-  Alternative Solution
-  Excess Inventory Management