

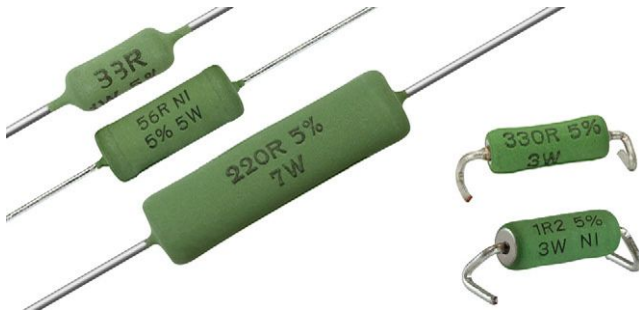

**THE DATASHEET OF
AC03000006807JAC00**



Standard: AC, AEC-Q200 Qualified: AC-AT, Non-Inductive AC-NI Cemented Leaded Wirewound Resistors



LINKS TO ADDITIONAL RESOURCES



The AC, AC-AT and AC-NI series are the perfect choice for general purpose power electronics, industrial and automotive electronics applications. The robust silicone cement coating can handle challenging ambient and operating conditions. Typical applications include but not limited to pre-charging, discharging, snubber and in-rush current limiting. For a given application, requirements of ohmic value, rated power, peak voltage, pulse shape, pulse duration, lead bending, and environmental conditions may be submitted to recommend the most suitable product.

Various lead forms are available such as RT (radial taped), WSZ (Z-form), DK (double kink), EK (single kink) with defined mounting pitch.

FEATURES

- Standard: AC series
- AEC-Q200 qualified: AC-AT series
- AEC-Q200 qualified, non-inductive: AC-NI series
- High power dissipation in small design
- Flameproof insulation coating meets UL 94 V-0 requirements
- Excellent pulse load capability
- WSZ-form lead bending available for SMD mounting
- Material categorization: for definitions of compliance please see www.vishay.com/doc?99912



RoHS
COMPLIANT
HALOGEN
FREE
GREEN
(5-2008)

APPLICATIONS

- Automotive electronics:
 - Pre-charging / discharging applications in xEV
 - Snubber circuit
 - Energy absorber load resistor
- Industrial electronics, energy meter
- Power supplies
- White goods

STANDARD ELECTRICAL SPECIFICATIONS

TYPE	RATED DISSIPATION P_{40}	RATED DISSIPATION P_{70}	LIMITING VOLTAGE U_{max}	RESISTANCE RANGE ⁽¹⁾ TCR = -10 ppm/K to -80 ppm/K ⁽²⁾	RESISTANCE RANGE ⁽¹⁾ TCR = +100 ppm/K to +180 ppm/K ⁽²⁾	RESISTANCE RANGE ⁽¹⁾ TCR = ± 100 ppm/K ⁽²⁾	RESISTANCE TOLERANCE
AC01, AC01-AT	1 W	0.9 W	$\sqrt{P \times R}$	0.10 Ω to 33 Ω	36 Ω to 2.4 k Ω	-	± 5 %
AC03	3 W	2.5 W	$\sqrt{P \times R}$	0.10 Ω to 390 Ω	430 Ω to 3.3 k Ω	3.6 k Ω to 5.1 k Ω	± 5 %
AC03-AT	3 W	2.5 W	$\sqrt{P \times R}$	0.10 Ω to 390 Ω	430 Ω to 3.3 k Ω	-	± 5 %
AC04, AC04-AT	4 W	3.5 W	$\sqrt{P \times R}$	0.10 Ω to 620 Ω	680 Ω to 6.8 k Ω	-	± 5 %
AC05, AC05-AT	5 W	4.7 W	$\sqrt{P \times R}$	0.10 Ω to 910 Ω	1.0 k Ω to 10 k Ω	-	± 5 %
AC07, AC07-AT	7 W	5.8 W	$\sqrt{P \times R}$	0.10 Ω to 820 Ω	910 Ω to 15 k Ω	-	± 5 %
AC10, AC10-AT	10 W	8.4 W	$\sqrt{P \times R}$	0.22 Ω to 560 Ω	620 Ω to 27 k Ω	-	± 5 %

ELECTRICAL SPECIFICATIONS FOR AC-NI

TYPE	RATED DISSIPATION P_{40}	RATED DISSIPATION P_{70}	LIMITING VOLTAGE U_{max}	RESISTANCE RANGE ⁽¹⁾ TCR = -10 ppm/K to -80 ppm/K ⁽²⁾	RESISTANCE TOLERANCE	TYPICAL INDUCTANCE ⁽³⁾ nH
AC03-NI	3 W	2.5 W	$\sqrt{P \times R}$	0.10 Ω to 69 Ω	± 5 %	12 (for 0.1 Ω)
AC04-NI	4 W	3.5 W	$\sqrt{P \times R}$	0.10 Ω to 68 Ω	± 5 %	12 (for 0.1 Ω)
AC05-NI	5 W	4.7 W	$\sqrt{P \times R}$	0.18 Ω to 56 Ω	± 5 %	8 (for 0.18 Ω)

Notes

⁽¹⁾ Resistance value to be selected from E24 series

⁽²⁾ Temperature coefficient of resistive wire

⁽³⁾ Inductance values mentioned are typical, measured under controlled conditions.

For the product types and resistance ranges which are not given in above table, please contact factory at ww1resistors@vishay.com



PART NUMBER AND PRODUCT DESCRIPTION

Part Number: AC03000001509JAC00
 AC03AT0001509JAC00
 AC03NI0001008JAC00

A	C	0	3	0	0	0	0	0	1	5	0	9	J	A	C	0	0
A	C	0	3	A	T	0	0	0	1	5	0	9	J	A	C	0	0
A	C	0	3	N	I	0	0	0	1	0	0	8	J	A	C	0	0

MODEL	VARIANT (1)	TCR / MATERIAL	VALUE	TOLERANCE CODE	PACKAGING CODE	SPECIAL												
AC01000 = AC01 AC03000 = AC03 AC04000 = AC04 AC05000 = AC05 AC07000 = AC07 AC10000 = AC10 AC01AT0 = AC01-AT AC03AT0 = AC03-AT AC04AT0 = AC04-AT AC05AT0 = AC05-AT AC07AT0 = AC07-AT AC10AT0 = AC10-AT AC03NI0 = AC03-NI AC04NI0 = AC04-NI AC05NI0 = AC05-NI	0 = neutral 1 = RT 2 = SWI 3 = DK SP 20 mm 4 = DK LP 33 mm 5 = DK LP 17.8 mm 6 = not in use for new designs 7 = DK LP 25.4 mm 8 = DK SP 25.4 mm 9 = AC03 / AC03AT / AC03NI-WSZ A = EK 22.5 mm B = EK 17.8 mm C = EK 25.4 mm D = Cu wire 0.8 mm E = EK 33 mm G = DK SP 33 mm H = EK 20 mm I = DK SP 17.8 mm K = AC05 / AC05AT / AC05NI-WSZ	0 = standard	3 digit value 1 digit multiplier 7 = *10 ⁻³ 8 = *10 ⁻² 9 = *10 ⁻¹ 0 = *10 ⁰ 1 = *10 ¹ 2 = *10 ²	J = ± 5.0 %	<table border="1"> <tr><td>AC</td><td>LB</td></tr> <tr><td>A1</td><td>LC</td></tr> <tr><td>AB</td><td></td></tr> <tr><td>AE</td><td>BM</td></tr> <tr><td>AQ</td><td>BW</td></tr> <tr><td>R1</td><td>RC</td></tr> </table>	AC	LB	A1	LC	AB		AE	BM	AQ	BW	R1	RC	00 = standard 2 digit code = customized version
AC	LB																	
A1	LC																	
AB																		
AE	BM																	
AQ	BW																	
R1	RC																	

Product Description: AC03 15R 5 % AC
 AC03AT 15R 5 % AC
 AC03NI 1R0 5 % AC

AC03	15R	5 %	AC																														
AC03-AT	15R	5 %	AC																														
AC03-NI	1R	5 %	AC																														
TYPE	RESISTANCE	TOLERANCE	PACKAGING																														
<table border="1"> <tr><td>AC01</td><td>AC01-AT</td><td>AC03-NI</td></tr> <tr><td>AC03</td><td>AC03-AT</td><td>AC04-NI</td></tr> <tr><td>AC04</td><td>AC04-AT</td><td>AC05-NI</td></tr> <tr><td>AC05</td><td>AC05-AT</td><td></td></tr> <tr><td>AC07</td><td>AC07-AT</td><td></td></tr> <tr><td>AC10</td><td>AC10-AT</td><td></td></tr> </table>	AC01	AC01-AT	AC03-NI	AC03	AC03-AT	AC04-NI	AC04	AC04-AT	AC05-NI	AC05	AC05-AT		AC07	AC07-AT		AC10	AC10-AT		R10 = 0.1 Ω 15R = 15 Ω 1K2 = 1.2 kΩ	5 %	<table border="1"> <tr><td>AC</td><td>LB</td></tr> <tr><td>A1</td><td>LC</td></tr> <tr><td>AB</td><td>BM</td></tr> <tr><td>AE</td><td>BW</td></tr> <tr><td>AQ</td><td>RC</td></tr> <tr><td>R1</td><td></td></tr> </table>	AC	LB	A1	LC	AB	BM	AE	BW	AQ	RC	R1	
AC01	AC01-AT	AC03-NI																															
AC03	AC03-AT	AC04-NI																															
AC04	AC04-AT	AC05-NI																															
AC05	AC05-AT																																
AC07	AC07-AT																																
AC10	AC10-AT																																
AC	LB																																
A1	LC																																
AB	BM																																
AE	BW																																
AQ	RC																																
R1																																	

Note

- (1) RT= radial taped lead bending (refer page 11)
- SWI= special winding
- EK= single kink lead bending (refer page 10)
- DK LP= double kink large pitch lead bending (refer page 10)
- DK SP= double kink small pitch lead bending(refer page 10)
- WSZ= "Z" form leads (refer page 11)



PACKAGING							
TYPE / SIZE	CODE	DESCRIPTION	QUANTITY	PACKAGING STYLE	WIDTH	PITCH	DIMENSIONS
AC01 ⁽¹⁾ AC01-AT ⁽¹⁾	A1	A1	1000	Taped acc. to IEC 60286-1 fan-folded in a box	63 mm	10 mm	260 mm x 85 mm x 70 mm 260 mm x 85 mm x 80 mm
AC01 DK/EK	LC	LC	500	Bulk packaging	-	-	260 mm x 80 mm x 55 mm
AC01 RT	AE	AE	2500	Taped acc. to IEC 60286-2 fan-folded in a box	-	12.7 mm	200 mm x 46 mm x 334 mm
AC03 AC03-AT AC03-NI	AC	AC	500	Taped acc. to IEC 60286-1 fan-folded in a box	63 mm	10 mm	260 mm x 85 mm x 58 mm
AC03 DK/EK	LC	LC	500	Bulk packaging	-	-	224 mm x 82 mm x 54 mm
AC03 RT	AQ	AQ	1800	Taped acc. to IEC 60286-2 fan-folded in a box	-	12.7 mm	200 mm x 46 mm x 334 mm
AC03 AC03-AT AC03-NI	R1	R1	1000	Taped acc. to IEC 60286-1 on reel	63 mm	10 mm	260 mm x 90 mm x 257 mm
AC03 WSZ ⁽¹⁾ AC03-AT WSZ AC03-NI WSZ	BM	BM	1250	Blister taped acc. to IEC 60286-3 on reel	-	8 mm	350 mm x 335 mm x 35 mm
AC04 ⁽¹⁾ AC04-AT ⁽¹⁾ AC04-NI ⁽¹⁾	AC	AC	500	Taped acc. to IEC 60286-1 fan-folded in a box	63 mm	10 mm	260 mm x 85 mm x 70 mm 260 mm x 85 mm x 58 mm
AC04 DK/EK	LC	LC	500	Bulk packaging	-	-	224 mm x 82 mm x 54 mm
AC05 ⁽¹⁾ AC05-AT ⁽¹⁾ AC05-NI ⁽¹⁾	AC	AC	500	Taped acc. to IEC 60286-1 fan-folded in a box	63 mm	10 mm	270 mm x 86 mm x 118 mm 270 mm x 86 mm x 125 mm
AC05 DK/EK	LC	LC	500	Bulk packaging	-	-	224 mm x 82 mm x 54 mm
AC05 AC05-AT AC05-NI	RC	RC	500	Taped acc. to IEC 60286-1 on reel	63 mm	10 mm	260 mm x 90 mm x 257 mm
AC05 WSZ ⁽¹⁾ AC05-AT WSZ AC05-NI WSZ	BW	BW	350	Blister taped acc. to IEC 60286-3 on reel	-	16 mm	350 mm x 335 mm x 60 mm
AC05 AC05-AT AC05-NI	GC	GC	500	Taped acc. to IEC 60286-2 on reel	-	12.7 mm	365 mm x 370 mm x 67 mm
AC07 AC07-AT	AC	AC	500	Taped acc. to IEC 60286-1 fan-folded in a box	73 mm	10 mm	265 mm x 90 mm x 118 mm
AC07 DK/EK	LB	LB	250	Bulk packaging	-	-	224 mm x 82 mm x 54 mm
AC10 AC10-AT	AB	AB	250	Taped acc. to IEC 60286-1 fan-folded in a box	88 mm	10 mm	265 mm x 105 mm x 70 mm

Note

⁽¹⁾ Manufacturing at different production locations may involve use of differently sized box



DESCRIPTION

Wirewound resistors are best suited for use in high power, high current applications. The silicone cement lacquer coating enables AC, AC-AT, AC-NI series to withstand challenging operating and environmental conditions. The coating is resistant to cleaning solvents specified in IEC 60115-1 ⁽¹⁾. Production is strictly controlled and follows an extensive set of instructions established for reproducibility.

The winding is done with a specific material on a specially developed fine ceramic body (Al₂O₃). The ceramic meets the highest requirements against mechanical resistance, thermal shocks, dielectric strength, and insulation resistance at high temperatures. With different diameters and turn spacings of resistive wire, a large ohmic value range can be covered.

The resistors are marked with resistance, rated dissipation (P₄₀) and tolerance. Product quality is verified by testing procedures, performed on all individual resistors. Resistance is measured on the lead wires at a distance of 6 mm from the resistor body. If a greater length of lead wire is used in the application, the user may need to consider the additional wire resistance, particularly with low resistance products.

MATERIALS

Vishay acknowledges the following systems for the regulation of hazardous substances:

- IEC 62474, Material Declaration for Products of and for the Electrotechnical Industry, with the list of declarable substances given therein ⁽²⁾
- The Global Automotive Declarable Substance List (GADSL) ⁽³⁾
- The REACH regulation (1907/2006/EC) and the related list of substances with very high concern (SVHC) ⁽⁴⁾ for its supply chain

The products do not contain any of the banned substances as per IEC 62474, GADSL, or the SVHC list, see www.vishay.com/how/leadfree. Hence the products fully comply with the following directives:

- 2000/53/EC End-of-Life Vehicle Directive (ELV) and Annex II (ELV II)
- 2011/65/EU Restriction of the Use of Hazardous Substances Directive (RoHS) with amendment 2015/863/EU
- 2012/19/EU Waste Electrical and Electronic Equipment Directive (WEEE)

Vishay pursues the elimination of conflict minerals from its supply chain, see the Conflict Minerals Policy at www.vishay.com/doc?49037

Notes

- ⁽¹⁾ Other cleaning solvents with aggressive chemicals should be evaluated in actual cleaning process for their suitability
- ⁽²⁾ The IEC 62474 list of declarable substances is maintained in a dedicated database, which is available at <http://std.iec.ch/iec62474>
- ⁽³⁾ The Global Automotive Declarable Substance List (GADSL) is maintained by the American Chemistry Council and available at www.gadsl.org
- ⁽⁴⁾ The SVHC list is maintained by the European Chemical Agency (ECHA) and available at <http://echa.europa.eu/candidate-list-table>

ASSEMBLY

The resistors are axial or bend leads for soldering. Z bend leads offer SMD mounting compatibility. The terminals of the resistors are completely lead (Pb)-free, the special matte tin plating provides compatibility with lead (Pb)-free and lead-containing soldering processes.

Special lead forms may be available on request, please inquire at ww1resistors@vishay.com. As these components are high power dissipation resistors, customers are advised to use a high melting point solder.

APPLICATION INFORMATION

The power dissipation of the resistor generates a temperature rise with respect to the ambient. The permissible dissipation is derated for temperatures above 40 °C, as shown in the derating diagram, in order to avoid overheating of the resistor. The heat dissipated from the resistor may affect adjacent components, hence proper clearance will be required in order to avoid overheating. The resistive wire is encapsulated by a protective lacquer coating.

All materials used are non-flammable and inorganic.

These resistors do not feature a limited lifetime when operated within the permissible limits. However, resistance value drift increasing over operating time may result in exceeding a limit acceptable to the specific application, thereby establishing a functional lifetime.

APPROVALS

AC-AT, AC-NI series are AEC-Q200 qualified, specifically for the use in automotive applications.

RELATED PRODUCTS

UL approved, special cement coated fusible resistor is also available. For details please see the datasheet:

“AC01-CS, AC03-CS, AC05-CS - Axial Cemented Fusible Wirewound Safety Resistors” www.vishay.com/doc?28909

For high surge wirewound products, silicone cement coated Z300-Cxx series is available, see the datasheet:

“Z300-Cxx - High Surge Axial Cemented Wirewound Resistors” www.vishay.com/doc?21027

For precision applications, cemented leaded wirewound PAC series is available, see the datasheet:

“PAC Series - Cemented Wirewound Precision Resistors” www.vishay.com/doc?28731



PULSE DIAGRAMS FOR AC, AC-AT SERIES

(t_i = pulse duration; t_p = repetition time)

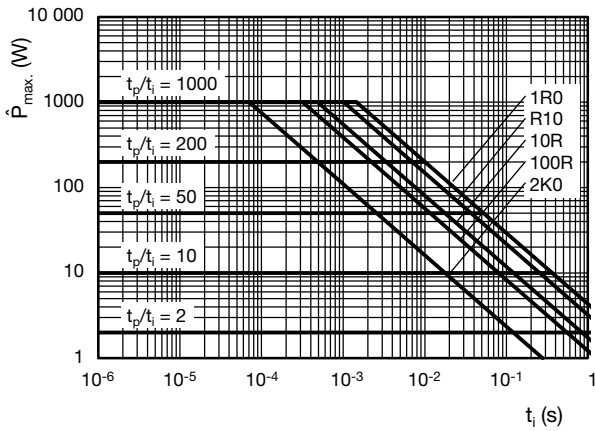

AC01 and AC01-AT Pulse on a regular basis; max. permissible peak pulse power (P max.) as a function of pulse duration (t_i)

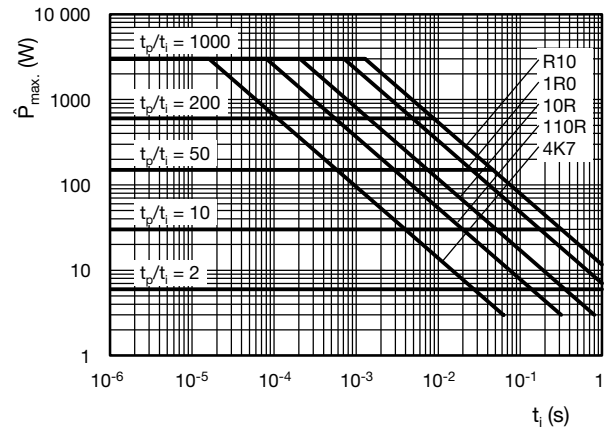

AC03 and AC03-AT Pulse on a regular basis; max. permissible peak pulse power (P max.) as a function of pulse duration (t_i)

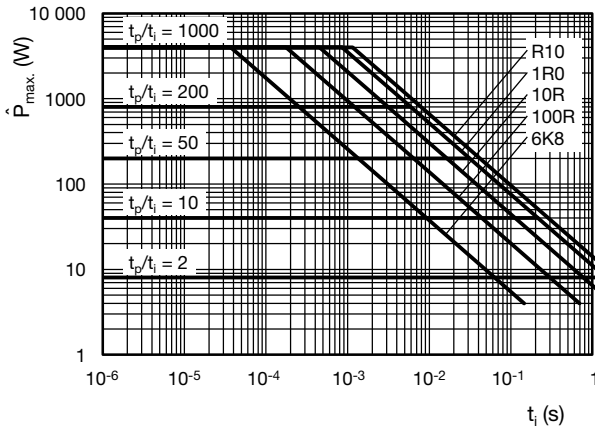

AC04 and AC04-AT Pulse on a regular basis; max. permissible peak pulse power (P max.) as a function of pulse duration (t_i)

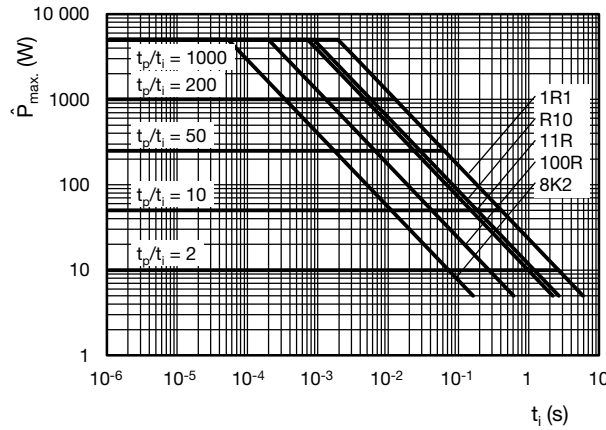

AC05 and AC05-AT Pulse on a regular basis; max. permissible peak pulse power (P max.) as a function of pulse duration (t_i)

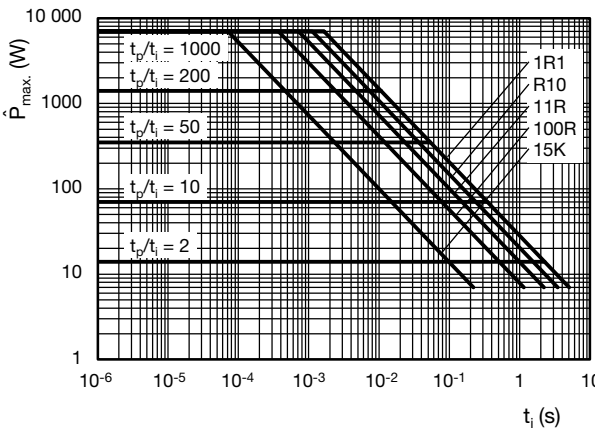

AC07 and AC07-AT Pulse on a regular basis; max. permissible peak pulse power (P max.) as a function of pulse duration (t_i)

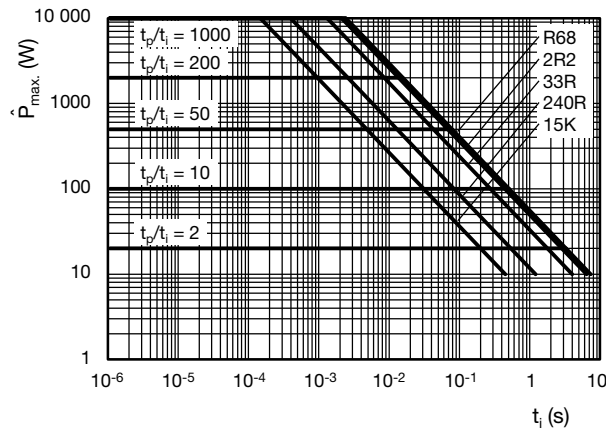

AC10 and AC10-AT Pulse on a regular basis; max. permissible peak pulse power (P max.) as a function of pulse duration (t_i)



PULSE DIAGRAMS FOR AC, AC-AT SERIES

Pulse energy in joules or wattseconds is calculated with the help of the R -value to be used in the application. Choose the R value on X axis and look for the corresponding E (Ws/ Ω) value on Y axis. Multiplying both the R (Ω) to corresponding E (Ws/ Ω), will be resultant total pulse Energy (Ws or J) for **adiabatic conditions**.

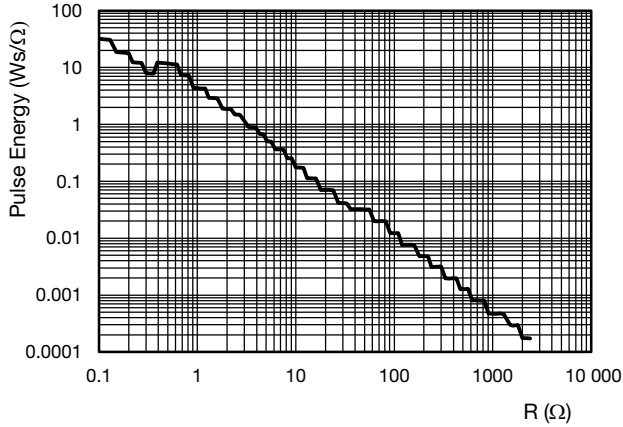

AC01 and AC01-AT Pulse capability; E (Ws) as a function of R (Ω)

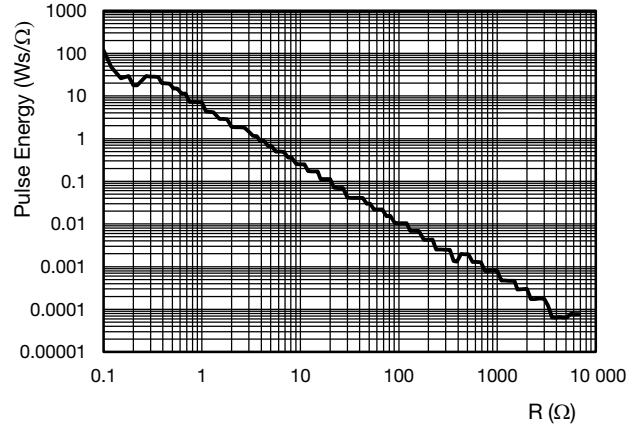

AC03 and AC03-AT Pulse capability; E (Ws) as a function of R (Ω)

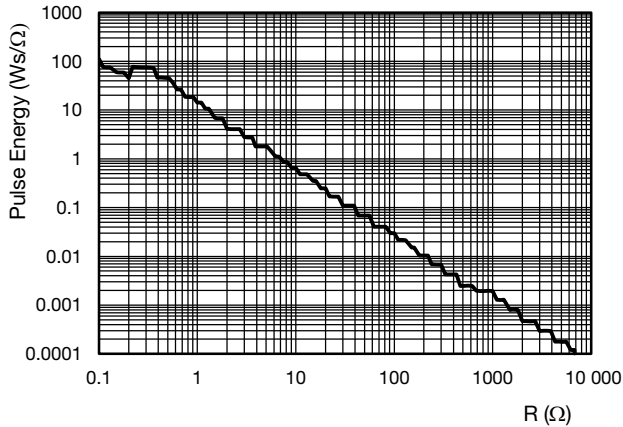

AC04 and AC04-AT Pulse capability; E (Ws) as a function of R (Ω)

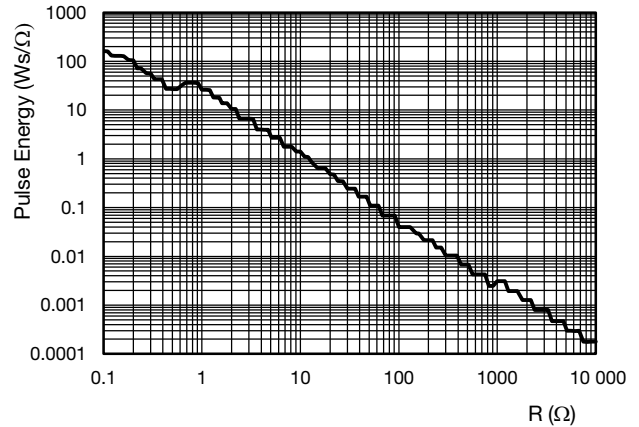

AC05 and AC05-AT Pulse capability; E (Ws) as a function of R (Ω)

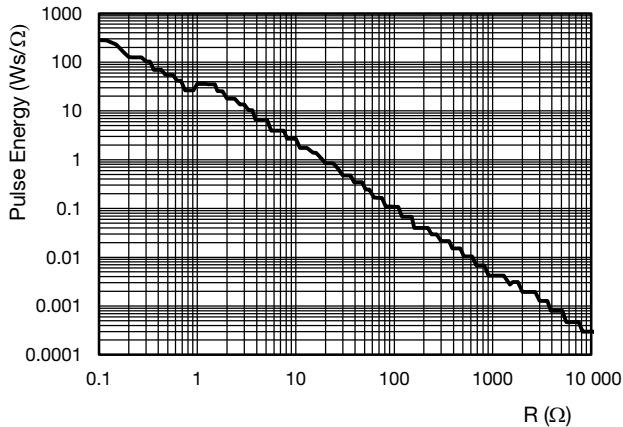

AC07 and AC07-AT Pulse capability; E (Ws) as a function of R (Ω)

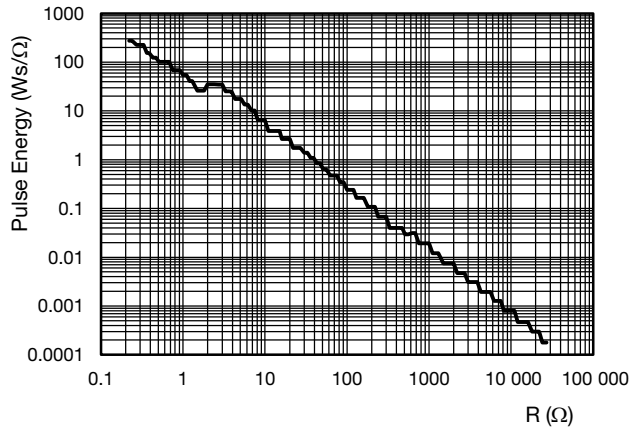

AC10 and AC10-AT Pulse capability; E (Ws) as a function of R (Ω)

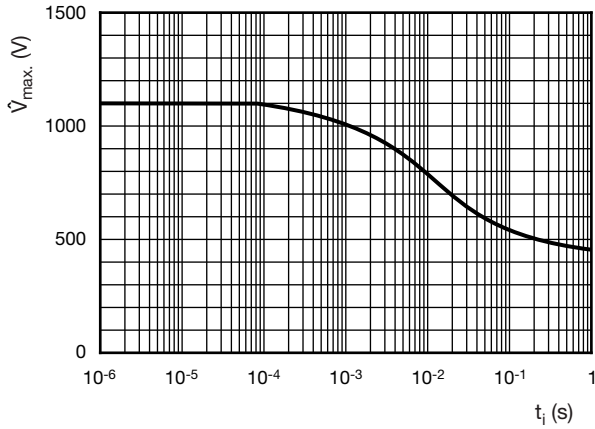

AC01 and AC01-AT Pulse on a regular basis; max. permissible peak pulse voltage ($\hat{V}_{max.}$) as a function of pulse duration (t_i)

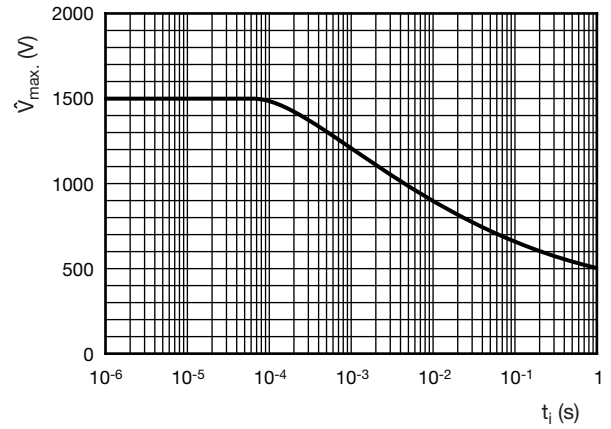

AC03 and AC03-AT Pulse on a regular basis; max. permissible peak pulse voltage ($\hat{V}_{max.}$) as a function of pulse duration (t_i)

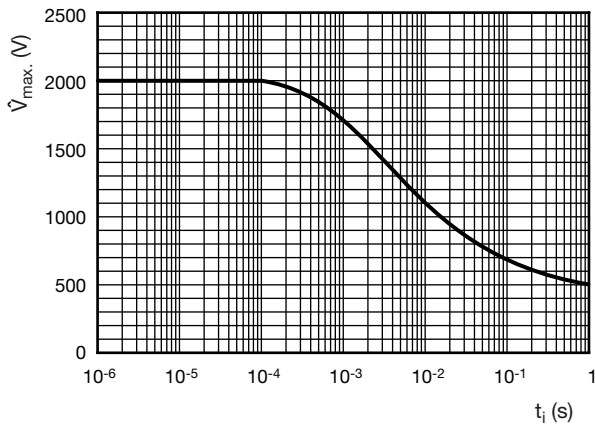

AC04 and AC04-AT Pulse on a regular basis; max. permissible peak pulse voltage ($\hat{V}_{max.}$) as a function of pulse duration (t_i)

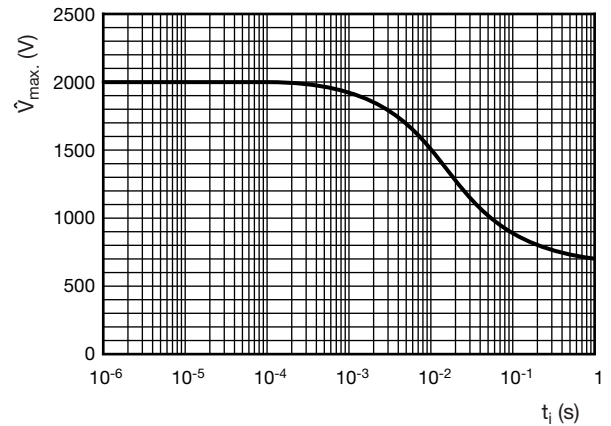

AC05 and AC05-AT Pulse on a regular basis; max. permissible peak pulse voltage ($\hat{V}_{max.}$) as a function of pulse duration (t_i)

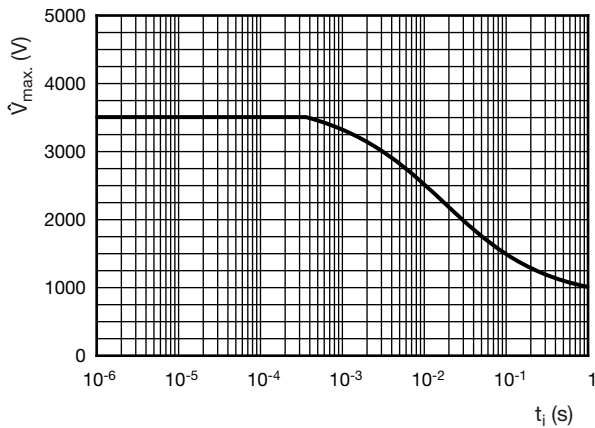

AC07 and AC07-AT Pulse on a regular basis; max. permissible peak pulse voltage ($\hat{V}_{max.}$) as a function of pulse duration (t_i)

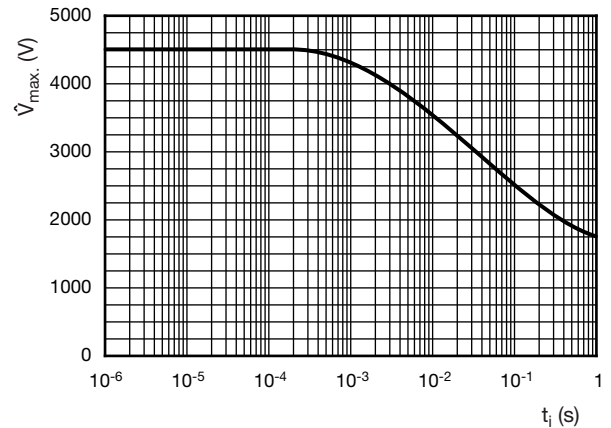

AC10 and AC10-AT Pulse on a regular basis; max. permissible peak pulse voltage ($\hat{V}_{max.}$) as a function of pulse duration (t_i)



FUNCTIONAL PERFORMANCE

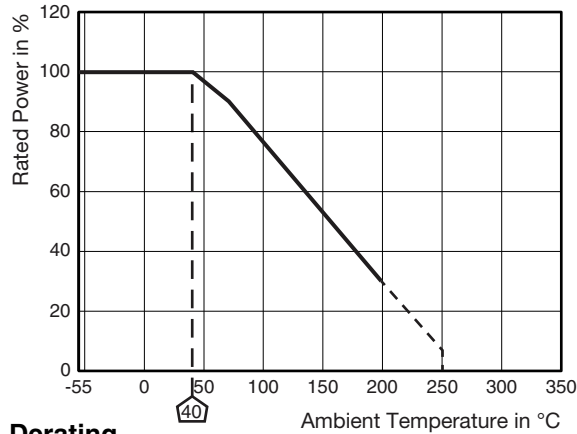

Derating

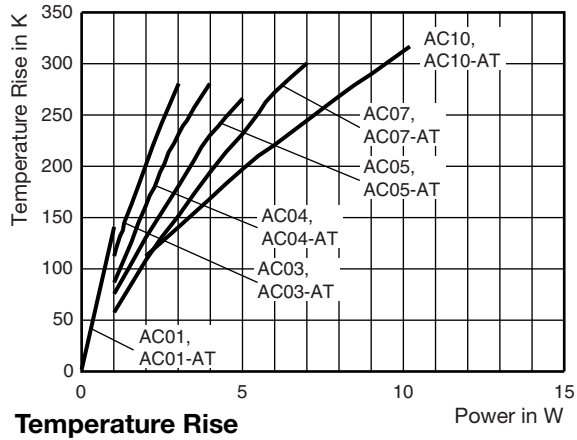

Temperature Rise



TEST PROCEDURES AND REQUIREMENTS

All tests are carried out in accordance with the following specifications:

- IEC 60115-1, generic specification (includes tests)

The test and requirements table contains only the most important tests. For the full test schedule refer to the documents above.

The tests are carried out in accordance with IEC 60068-2-xx test method and under standard atmospheric conditions in accordance with IEC 60068-1, 4.3.

Climatic category -55 / 200 / 56 (rated temperature range: lower category temperature, upper category temperature; damp heat, steady state, test duration: 56 days) is valid.

Unless otherwise specified the following values apply:

- Temperature: 15 °C to 35 °C
• Relative humidity: 25 % to 75 %
• Air pressure: 86 kPa to 106 kPa (860 mbar to 1060 mbar)

For performing some of the tests, the components are mounted on a test board in accordance with IEC 60115-1, 5.5.

In test procedures and requirements table, only the tests and requirements are listed with reference to the relevant clauses of IEC 60115-1 and IEC 60068-2-xx test methods. A short description of the test procedure is also given.

Table with 5 columns: IEC 60115-1 CLAUSE, IEC 60068-2 TEST METHOD, TEST, PROCEDURE, REQUIREMENTS PERMISSIBLE CHANGE (ΔR_MAX.). Rows include tests like Short term overload, Robustness of terminations, Resistance to soldering heat, etc.

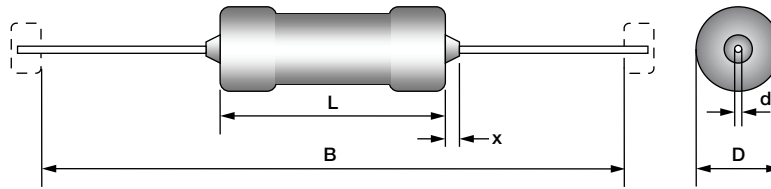
DIMENSION AND MASS

DIMENSIONS in millimeters						
TYPE	L _{max.}	D _{max.}	d ⁽¹⁾	x _{max.}	B	MASS PER UNIT (g)
AC01, AC01-AT	11.0	4.3	0.8 ± 0.03	2	63 ± 1	0.52
AC03, AC03-AT	13.0	4.8		2	63 ± 1	0.75
AC03-NI	13.0	4.8		2	63 ± 1	0.78
AC04, AC04-AT	16.5	5.5		3	63 ± 1	1.10
AC04-NI	16.5	5.5		3	63 ± 1	1.11
AC05, AC05-AT	18.0	7.5		3	63 ± 1	1.90
AC05-NI	18.0	7.5		3	63 ± 1	2.00
AC07, AC07-AT	26.0	7.5		3	73 ± 1	2.60
AC10, AC10-AT	44.0	8.0		3	88 ± 1	4.50

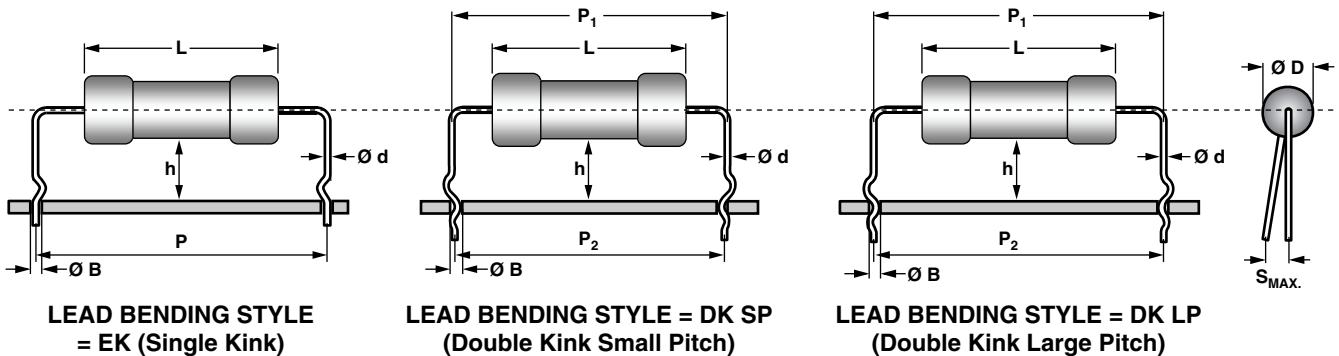
LEAD TERMINATION BENDING FORMS FOR AC, AC-AT

LEAD BENDING STYLE = EK (Single Kink)
LEAD BENDING STYLE = DK SP (Double Kink Small Pitch)
LEAD BENDING STYLE = DK LP (Double Kink Large Pitch)

DIMENSIONS - Single and double kink lead type outline												
TYPE	Ø D _{max.} (mm)	L _{max.} (mm)	KINK TYPE	TERMINATION WIRE DIAMETER ⁽¹⁾ Ø d (mm)	h ± 1 (mm)	P ± 0.5 (mm)	P ₁ ± 0.5 (mm)	P ₂ ± 3 (mm)	S _{max.} (mm)	Ø B ± 0.1 (mm)	MASS (g)	PART NUMBER VARIANT
AC01	4.3	11.0	EK	0.8 ± 0.03	8.0	17.8	-	-	2	1.0	0.52	B
			DK SP	0.8 ± 0.03	8.0	-	19.8	17.8	2	1.0	0.52	I
			DK LP	0.8 ± 0.03	8.0	-	17.8	17.8	2	1.0	0.52	5
AC03	4.8	13.0	EK	0.8 ± 0.03	8.0	20.0	-	-	2	1.0	0.75	H
			EK	0.8 ± 0.03	8.0	25.4	-	-	2	1.0	0.75	C
			DK SP	0.8 ± 0.03	8.0	-	22.0	20.0	2	1.0	0.75	3
			DK SP	0.8 ± 0.03	8.0	-	27.4	25.4	2	1.0	0.75	8
			DK LP	0.8 ± 0.03	8.0	-	17.8	17.8	2	1.0	0.75	5
			DK LP	0.8 ± 0.03	8.0	-	25.4	25.4	2	1.0	0.75	7
AC04	5.5	16.5	EK	0.8 ± 0.03	8.0	25.4	-	-	2	1.0	1.10	C
			DK SP	0.8 ± 0.03	8.0	-	22.0	20.0	2	1.0	1.10	3
			DK SP	0.8 ± 0.03	8.0	-	27.4	25.4	2	1.0	1.10	8
			DK LP	0.8 ± 0.03	8.0	-	25.4	25.4	2	1.0	1.10	7
AC05	7.5	18.0	EK	0.8 ± 0.03	8.0	22.5	-	-	2	1.0	1.90	A
			EK	0.8 ± 0.03	8.0	25.4	-	-	2	1.0	1.90	C
			DK SP	0.8 ± 0.03	8.0	-	22.0	20.0	2	1.0	1.90	3
AC07	7.5	26.0	EK	0.8 ± 0.03	8.0	33.0	-	-	2	1.0	2.60	E
			DK SP	0.8 ± 0.03	8.0	-	35.0	33.0	2	1.0	2.60	G
			DK LP	0.8 ± 0.03	8.0	-	33.0	33.0	2	1.0	2.60	4

Note

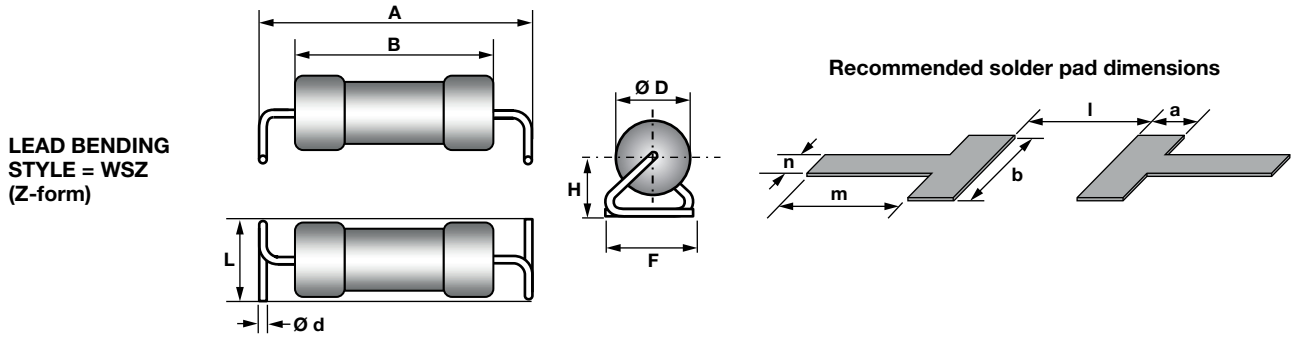
(1) Terminal wire material is FeCu with Sn coating

Z-FORM LEADS FOR SMD MOUNTING in millimeters

TYPE WSZ	$\varnothing d^{(1)}$	$\varnothing D_{max.}$	A	B	F	H	L	a	b	l	m	n
AC03, AC03-AT, AC03-NI	0.8 ± 0.03	4.8	17 ± 0.3	11 - 12	4.8 ± 0.3	3.6 ± 0.2	5.0 ± 0.5	4	8	12.2	25	2
AC05, AC05-AT, AC05-NI	0.8 ± 0.03	7.5	23.5 ± 0.5	18 max.	7.7 ± 0.5	5.73 ± 0.5	7.9 ± 0.7	4	10	18.7	25	2

Notes

(1) Terminal wire material is FeCu with Sn coating

- Given solder pad dimension is a suggestion only, used for testing purposes at practicable conditions. Customer has to reconsider temperature restrictions due to solder type, PCB-material, etc. according to individual application

AC01 WITH RADIAL TAPING

LEAD BENDING STYLE = RT (Radial Taped)

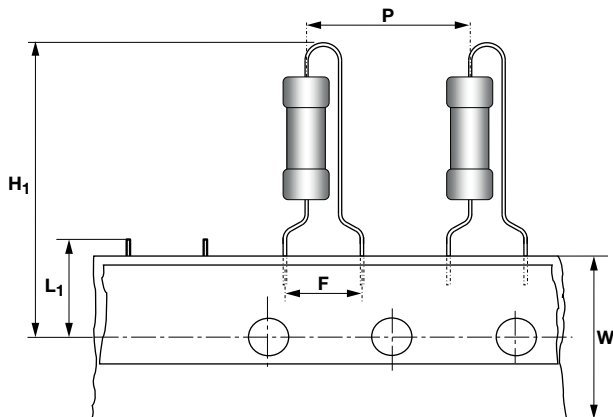

DIMENSIONS in millimeters		
Pitch of components	P	12.7 ± 1.0
Lead spacing	F	$5.0 + 0.6, - 0.1$
Width of carrier tape	W	18.0 ± 0.5
Height for cutting (max.)	L ₁	11
Height for insertion (max.)	H ₁	32

AC03 WITH RADIAL TAPING

LEAD BENDING STYLE = RT (Radial Taped)

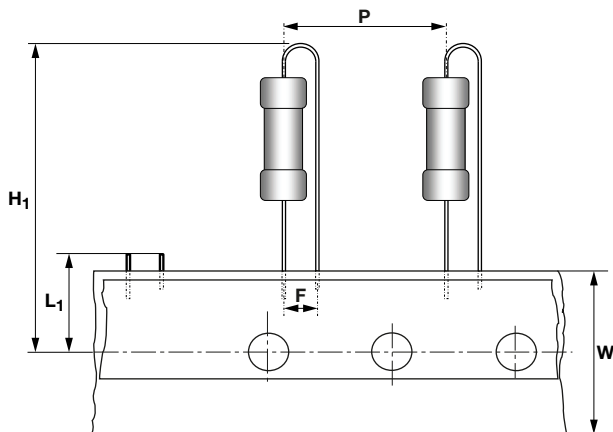

DIMENSIONS in millimeters		
Pitch of components	P	12.7 ± 1.0
Lead spacing	F	$5.0 + 0.4, - 0.2$
Width of carrier tape	W	18.0 ± 0.5
Height for cutting (max.)	L ₁	11
Height for insertion (max.)	H ₁	32

AC05 WITH RADIAL TAPING

LEAD BENDING STYLE = RT (Radial Taped)

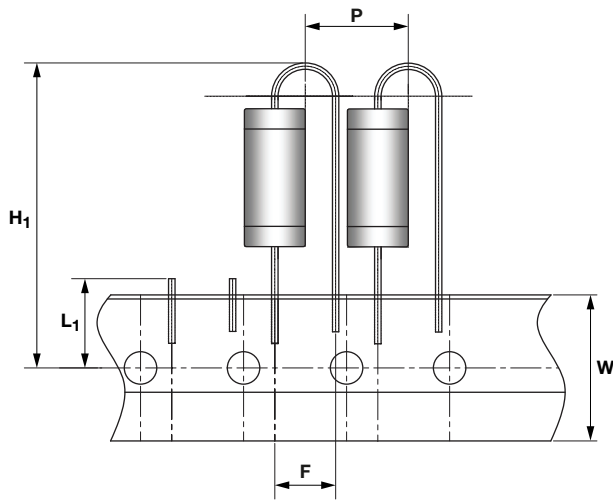

DIMENSIONS in millimeters		
Pitch of components	P	12.7 ± 1.0
Lead spacing	F	7.50 ± 0.5
Width of carrier tape	W	18.0 ± 0.5
Height for cutting (max.)	L ₁	11
Height for insertion (max.)	H ₁	37



Disclaimer

ALL PRODUCT, PRODUCT SPECIFICATIONS AND DATA ARE SUBJECT TO CHANGE WITHOUT NOTICE TO IMPROVE RELIABILITY, FUNCTION OR DESIGN OR OTHERWISE.

Vishay Intertechnology, Inc., its affiliates, agents, and employees, and all persons acting on its or their behalf (collectively, "Vishay"), disclaim any and all liability for any errors, inaccuracies or incompleteness contained in any datasheet or in any other disclosure relating to any product.

Vishay makes no warranty, representation or guarantee regarding the suitability of the products for any particular purpose or the continuing production of any product. To the maximum extent permitted by applicable law, Vishay disclaims (i) any and all liability arising out of the application or use of any product, (ii) any and all liability, including without limitation special, consequential or incidental damages, and (iii) any and all implied warranties, including warranties of fitness for particular purpose, non-infringement and merchantability.

Statements regarding the suitability of products for certain types of applications are based on Vishay's knowledge of typical requirements that are often placed on Vishay products in generic applications. Such statements are not binding statements about the suitability of products for a particular application. It is the customer's responsibility to validate that a particular product with the properties described in the product specification is suitable for use in a particular application. Parameters provided in datasheets and / or specifications may vary in different applications and performance may vary over time. All operating parameters, including typical parameters, must be validated for each customer application by the customer's technical experts. Product specifications do not expand or otherwise modify Vishay's terms and conditions of purchase, including but not limited to the warranty expressed therein.

Hyperlinks included in this datasheet may direct users to third-party websites. These links are provided as a convenience and for informational purposes only. Inclusion of these hyperlinks does not constitute an endorsement or an approval by Vishay of any of the products, services or opinions of the corporation, organization or individual associated with the third-party website. Vishay disclaims any and all liability and bears no responsibility for the accuracy, legality or content of the third-party website or for that of subsequent links.

Vishay products are not designed for use in life-saving or life-sustaining applications or any application in which the failure of the Vishay product could result in personal injury or death unless specifically qualified in writing by Vishay. Customers using or selling Vishay products not expressly indicated for use in such applications do so at their own risk. Please contact authorized Vishay personnel to obtain written terms and conditions regarding products designed for such applications.

No license, express or implied, by estoppel or otherwise, to any intellectual property rights is granted by this document or by any conduct of Vishay. Product names and markings noted herein may be trademarks of their respective owners.

Looking for pricing, stock, or lifecycle information?

Click below to explore more details on WIN SOURCE:

⊖ [View AC03000006807JAC00 on WIN SOURCE](#)

⊖ [Vishay Information](#)

Optimize Your Supply Chain with WIN SOURCE Solutions

- ✓ Global Sourcing Solution
- ✓ Obsolete Management
- ✓ Cost Control Management
- ✓ Shortage Management
- ✓ Alternative Solution
- ✓ Excess Inventory Management