



**THE DATASHEET OF
LEA-F9T-20B**



LEA-F9T-20B

High accuracy timing module
Professional grade

Data sheet

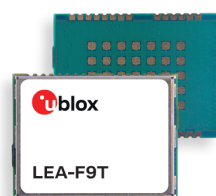

Abstract

This data sheet describes the LEA-F9T timing module with multi-band GNSS receiver and nanosecond-level timing accuracy. LEA-F9T meets the most stringent 5G timing requirements, is ideal for global deployment due to GPS, BeiDou, Galileo, and GLONASS reception, and is unaffected by ionospheric errors. The module provides differential timing mode for highly accurate local timing and built-in security for highest robustness against malicious attacks.

Document information

Title	LEA-F9T-20B	
Subtitle	High accuracy timing module	
Document type	Data sheet	
Document number	UBX-22038377	
Revision and date	R03	21-Mar-2024
Disclosure restriction	C1-Public	

Product status	Corresponding content status	
Functional Sample	Draft	For functional testing. Revised and supplementary data will be published later.
In development / prototype	Objective specification	Target values. Revised and supplementary data will be published later.
Engineering sample	Advance information	Data based on early testing. Revised and supplementary data will be published later.
Initial production	Early production information	Data from product verification. Revised and supplementary data may be published later.
Mass production / End of life	Production information	Document contains the final product specification.

This document applies to the following products:

Product name	Type number	FW version	IN/PCN reference	Product status
LEA-F9T	LEA-F9T-20B-01	TIM 2.22	UBXDOC-963802114-12622	Initial production

u-blox or third parties may hold intellectual property rights in the products, names, logos and designs included in this document. Copying, reproduction, or modification of this document or any part thereof is only permitted with the express written permission of u-blox. Disclosure to third parties is permitted for clearly public documents only.

The information contained herein is provided "as is" and u-blox assumes no liability for its use. No warranty, either express or implied, is given, including but not limited to, with respect to the accuracy, correctness, reliability and fitness for a particular purpose of the information. This document may be revised by u-blox at any time without notice. For the most recent documents, visit www.u-blox.com.

Copyright © 2024, u-blox AG.

Contents

1 Functional description.....	4
1.1 Overview.....	4
1.2 Performance.....	4
1.3 Supported GNSS constellations.....	5
1.4 Supported GNSS augmentation systems.....	6
1.4.1 Quasi-Zenith Satellite System (QZSS).....	6
1.4.2 Satellite-based augmentation system (SBAS).....	6
1.4.3 Differential timing mode.....	6
1.5 Broadcast navigation data and satellite signal measurements.....	6
1.5.1 Carrier-phase measurements.....	6
1.6 Supported protocols.....	7
2 System description.....	8
2.1 Block diagram.....	8
3 Pin definition.....	9
3.1 Pin assignment.....	9
4 Electrical specification.....	11
4.1 Absolute maximum ratings.....	11
4.2 Operating conditions.....	11
4.3 Indicative power requirements.....	12
5 Communications interfaces.....	13
5.1 UART.....	13
5.2 SPI.....	13
5.3 I2C.....	14
5.4 USB.....	16
5.5 Default interface settings.....	16
6 Mechanical specification.....	17
7 Qualifications and approvals.....	19
8 Labeling and ordering information.....	20
8.1 Product labeling.....	20
8.2 Explanation of product codes.....	20
8.3 Ordering codes.....	20
Related documents.....	21
Revision history.....	22

1 Functional description

1.1 Overview

The LEA-F9T is a multi-band GNSS module offering 5 ns (1-sigma) timing accuracy with unparalleled low power consumption.

The LEA-F9T incorporates the u-blox F9 multi-band platform in a small surface-mount device with a form factor of 22 x 17 mm.

1.2 Performance

Parameter	Specification	
Receiver type	Multi-band GNSS receiver for timing applications	
Accuracy of time pulse signal ¹	Absolute timing mode	5 ns
	Differential timing mode ²	2.5 ns
Frequency of time pulse signal	0.25 Hz to 25 MHz (configurable)	
Time pulse jitter	±4 ns	
Time-mark resolution	8 ns	
Operational limits ³	Dynamics	≤ 4 g
	Altitude	80,000 m
	Velocity	500 m/s
Velocity accuracy ⁴	0.05 m/s	
Dynamic heading accuracy ⁴	0.3 deg	

Table 1: LEA-F9T specifications

GNSS		GPS+GLO+GAL+BDS	GPS+BDS+GAL	GPS+GAL	GPS+GLO	GPS+BDS	GPS
Acquisition ⁵	Cold start	24 s	25 s	29 s	26 s	28 s	29 s
	Hot start	2 s	2 s	2 s	2 s	2 s	2 s
	Aided start ⁶	2 s	2 s	2 s	2 s	2 s	2 s
Max navigation update rate ⁷		6 Hz	7 Hz	15 Hz	15 Hz	12 Hz	20 Hz

Table 2: LEA-F9T performance in different GNSS modes

¹ 1-sigma, fixed position mode, depends on temperature, atmospheric conditions, baseline length, GNSS antenna, multipath conditions, satellite visibility and geometry

² Demonstrated with 20 km baseline

³ Assuming Airborne 4 g platform

⁴ 50% at 30 m/s for dynamic operation

⁵ Commanded starts. All satellites at -130 dBm. Measured at room temperature. Dual band operation

⁶ Dependent on the speed and latency of the aiding data connection, commanded starts

⁷ 95% In PVT navigation mode, assumes secondary navigation output disabled (default)

GNSS		GPS+GLO+GAL+BDS	GPS+BDS+GAL	GPS+GAL	GPS+GLO	GPS+BDS	GPS
Horizontal position accuracy (CEP)	Standalone ⁸	1.5 m	1.5 m	1.5 m	1.5 m	1.5 m	1.5 m

Table 3: LEA-F9T position accuracy in different GNSS modes

In order to achieve the best absolute timing accuracy, measure the propagation delay of the entire signal path from the antenna to the receiver's time pulse output, and then compensate for this delay using the CFG-TP configuration items.

GNSS		GPS+GLO+GAL+BDS
Sensitivity ⁹	Tracking and nav.	-167 dBm
	Reacquisition	-160 dBm
	Cold start	-148 dBm
	Hot start	-157 dBm

Table 4: LEA-F9T sensitivity

1.3 Supported GNSS constellations

The LEA-F9T GNSS module is a concurrent GNSS receiver that can receive and track multiple GNSS systems. Thanks to the multi-band RF front-end architecture, all four major GNSS constellations (GPS, Galileo, GLONASS and BeiDou) as well as NavIC, SBAS and QZSS satellites can be received concurrently. The LEA-F9T can be configured to function as a L1, L2 or L1, L5 dual-band receiver. If low power consumption is a key factor, then the receiver can be configured for a subset of GNSS constellations.

The LEA-F9T can receive the NavIC L5 satellite signals that share the same frequency with GPS L5 signals and can be configured to work on its own or in parallel with the other GNSS constellations.

The QZSS system shares the same frequency bands with GPS and can only be processed in conjunction with GPS.

To benefit from multi-band signal reception, dedicated hardware preparation must be made during the design-in phase. See the Integration manual [1] for u-blox design recommendations.

The LEA-F9T supports the GNSS and their signals as shown in [Table 5](#).¹⁰

GPS / QZSS	GLONASS	Galileo	BeiDou	NavIC
L1C/A (1575.420 MHz)	L1OF (1602 MHz + k*562.5 kHz, k = -7,...,6)	E1-B/C (1575.420 MHz)	B1I (1561.098 MHz) B1C (1575.420 MHz)	-
L2C (1227.600 MHz)	-	E5b (1207.140 MHz)	B2I (1207.140 MHz)	-
L5 (1176.450 MHz)	-	E5a (1176.450 MHz)	B2a (1176.450 MHz)	SPS-L5 (1176.450 MHz)

Table 5: Supported GNSS signals on LEA-F9T

The LEA-F9T can use the u-blox AssistNow™ Online service which provides GNSS assistance information.

⁸ Depends on atmospheric conditions, GNSS antenna, multipath conditions, satellite visibility, and geometry

⁹ Demonstrated with a good external LNA. Measured at room temperature.

¹⁰ Only L1, L2 or L1, L5 bands can be supported concurrently

1.4 Supported GNSS augmentation systems

1.4.1 Quasi-Zenith Satellite System (QZSS)

The Quasi-Zenith Satellite System (QZSS) is a regional navigation satellite system that provides positioning services for the Pacific region covering Japan and Australia. The LEA-F9T is able to receive and track QZSS signals concurrently with GPS signals, resulting in better availability especially under challenging signal conditions, e.g. in urban canyons.

 QZSS can be enabled only if GPS operation is also configured.

1.4.2 Satellite-based augmentation system (SBAS)

The LEA-F9T supports SBAS (including WAAS in the US, EGNOS in Europe, L1Sb(QZSS SBAS) in Japan and GAGAN in India) to deliver improved location accuracy within the regions covered. However, the additional inter-standard time calibration step used during SBAS reception results in degraded time accuracy overall.

 SBAS reception is disabled by default in LEA-F9T.

1.4.3 Differential timing mode

To improve timing accuracy locally, the LEA-F9T can be used in differential timing mode, in which correction data is sent to neighboring LEA-F9T timing receivers via a communication network.

In differential timing mode the LEA-F9T can operate either as a reference station generating the following RTCM 3.3 messages, or as a corrected station using the following RTCM 3.3 messages:

Message type	Description
RTCM 1005	Stationary RTK reference station ARP
RTCM 1077	GPS MSM7
RTCM 1087	GLONASS MSM7
RTCM 1097	Galileo MSM7
RTCM 1127	BeiDou MSM7
RTCM 1230	GLONASS code-phase biases
RTCM 4072.1	Additional reference station information (u-blox proprietary RTCM Message)

Table 6: Supported RTCM 3.3 messages

1.5 Broadcast navigation data and satellite signal measurements

The LEA-F9T can output all the GNSS broadcast data upon reception from tracked satellites. This includes all the supported GNSS signals as well as the QZSS and SBAS augmentation services. The UBX-RXM-SFRBX message provides this information, see the Interface description [2] for the UBX-RXM-SFRBX message specification. The receiver can provide satellite signal information in a form compatible with the Radio Resource LCS Protocol (RRLP) [4].

1.5.1 Carrier-phase measurements

The LEA-F9T modules provide raw carrier-phase data for all supported signals, along with pseudorange, Doppler and measurement quality information. The data contained in the UBX-RXM-RAWX message follows the conventions of a multi-GNSS RINEX 3 observation file. For the UBX-RXM-RAWX message specification, see Interface description [2].



Raw measurement data are available once the receiver has established data bit synchronization and time-of-week.

1.6 Supported protocols

The LEA-F9T supports the following protocols:

Protocol	Type
UBX	Input/output, binary, u-blox proprietary
NMEA 4.11 (default), 4.10, 4.0, 2.3, and 2.1	Input/output, ASCII
RTCM 3.3	Input/output, binary

Table 7: Supported protocols

For specification of the protocols, see the Interface description [2].

2 System description

2.1 Block diagram

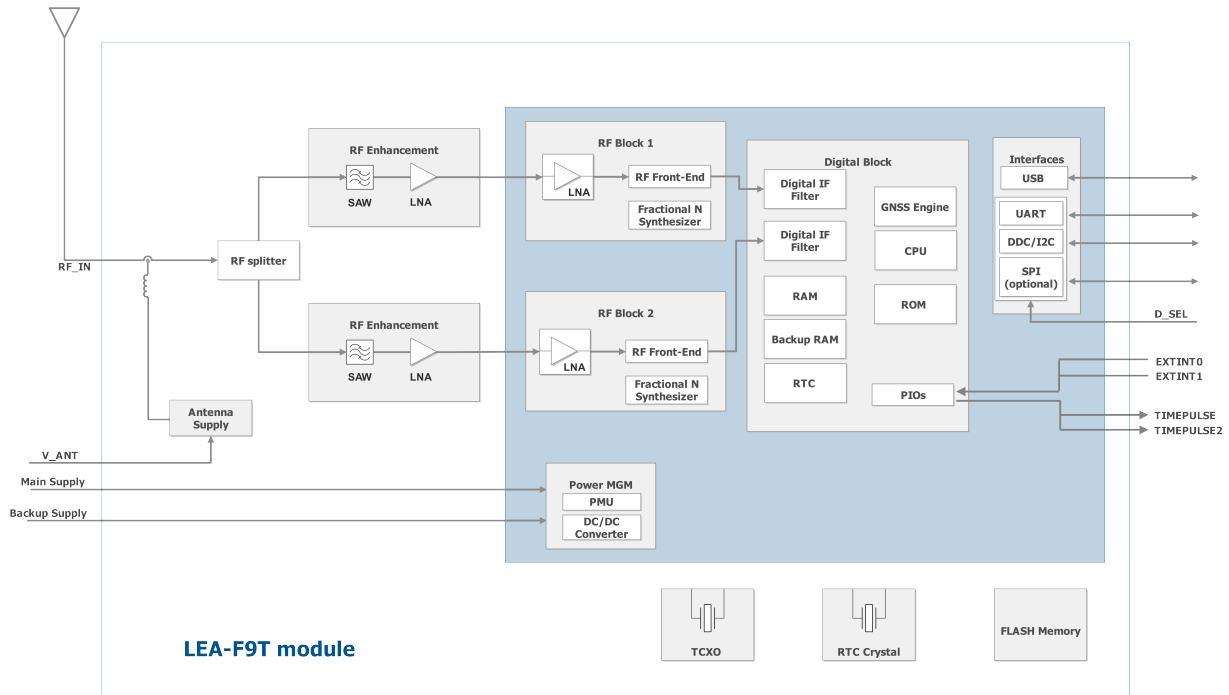

Figure 1: LEA-F9T block diagram



An active antenna is recommended for use with the LEA-F9T. For more information, see the Integration manual [1].

3 Pin definition

3.1 Pin assignment

The pin assignment of the LEA-F9T module is shown in [Figure 2](#). The defined configuration of the PIOs is listed in [Table 8](#).

For detailed information on pin functions and characteristics, see the LEA-F9T Integration manual [1].



The LEA-F9T is an LCC package with the I/O, power connections on the outside edge and central ground pads.

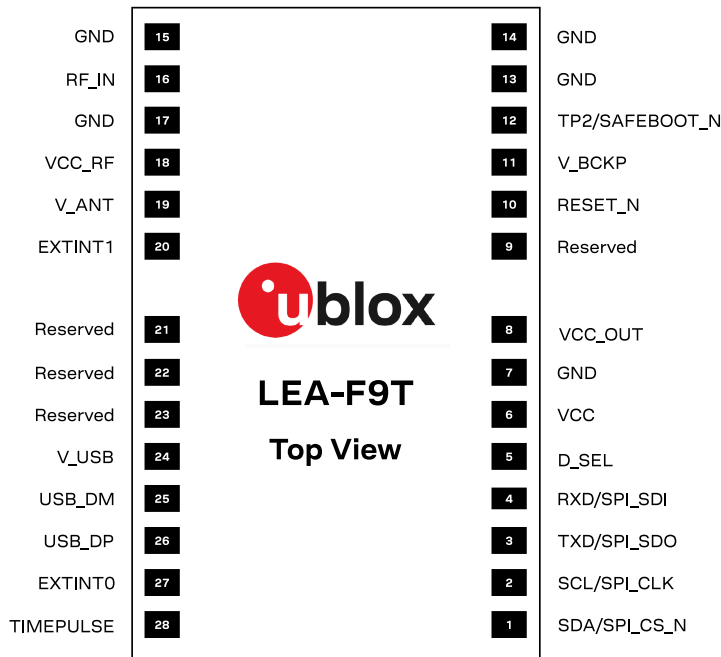

Figure 2: LEA-F9T pin assignment

Pin no.	Name	I/O	Description
1	SDA / SPI_CS_N	I/O	I2C data if D_SEL = 1 (or open) / SPI_CS_N if D_SEL = 0
2	SCL / SPI_CLK	I/O	I2C clock if D_SEL = 1 (or open). SPI Clock if D_SEL = 0
3	TXD / SPI_SDO	O	Host UART1 output if D_SEL = 1 (or open). SPI_SDO if D_SEL = 0
4	RXD / SPI_SDI	I	Host UART1 input if D_SEL = 1 (or open). SPI_SDI if D_SEL = 0
5	D_SEL	I	Interface select for pins 1-4
6	VCC	I	Voltage supply
7	GND	-	Ground
8	VCC_OUT	O	Output voltage. Leave open if not used.
9	Reserved	-	Reserved
10	RESET_N	I	RESET_N
11	V_BCKP	I	Backup supply voltage
12	SAFEBOOT_N/TP2	I/O	Time pulse 2 / SAFEBOOT_N (for future service, updates and reconfiguration)
13	GND	-	Ground
14	GND	-	Ground

Pin no.	Name	I/O	Description
15	GND	-	Ground
16	RF_IN	I	RF input
17	GND	-	Ground
18	VCC_RF	O	Voltage for external LNA
19	V_ANT	I	Active antenna voltage supply
20	EXTINT1	I	External interrupt pin 1
21	Reserved	-	Reserved
22	Reserved	-	Reserved
23	Reserved	-	Reserved
24	V_USB	I	USB supply
25	USB_DM	I/O	USB data
26	USB_DP	I/O	USB data
27	EXTINT0	I	External interrupt pin 0
28	TIMEPULSE 1	O	Time pulse 1

Table 8: LEA-F9T pin assignment

4 Electrical specification

4.1 Absolute maximum ratings

- CAUTION. Risk of device damage. Exceeding the absolute maximum ratings may affect the lifetime and reliability of the device or permanently damage it. Do not exceed the absolute maximum ratings.
- This product is not protected against overvoltage or reversed voltages. Use appropriate protection to avoid device damage from voltage spikes exceeding the specified boundaries.

Parameter	Symbol	Condition	Min	Max	Units
Power supply voltage	VCC		-0.5	3.6	V
Voltage ramp on VCC ¹¹			20	8000	µs/V
Backup battery voltage	V_BCKP		-0.5	3.6	V
Voltage ramp on V_BCKP ¹¹			20		µs/V
Input pin voltage	V _{in}	VCC ≤ 3.1 V	-0.5	VCC + 0.5	V
		VCC > 3.1 V	-0.5	3.6	V
VCC_RF output current	ICC_RF			300	mA
Supply voltage USB	V_USB		-0.5	3.6	V
USB signals	USB_DM, USB_DP		-0.5	V_USB + 0.5	V
Input power at RF_IN	Pr _{fin}	source impedance = 50 Ω, continuous wave		10	dBm
Storage temperature	T _{stg}		-40	+85	°C

Table 9: Absolute maximum ratings

4.2 Operating conditions

- Extreme operating temperatures can significantly impact the specified values. If an application operates near the min or max temperature limits, ensure the specified values are not exceeded.

Parameter	Symbol	Min	Typical	Max	Units	Condition
Power supply voltage	VCC	2.7	3.0	3.6	V	
Backup battery voltage	V_BCKP	1.65		3.6	V	
Backup battery current ^{12, 13}	I_BCKP		45		µA	V_BCKP = 3 V, VCC = 0 V
SW backup current ¹³	I_SWBCKP		10		mA	
Input pin voltage range	V _{in}	0		VCC	V	
Digital IO pin low level input voltage	V _{il}			0.4	V	
Digital IO pin high level input voltage	V _{ih}	0.8 * VCC			V	
Digital IO pin low level output voltage TIMEPULSE	V _{ol}			0.4	V	I _{ol} = 2 mA I _{ol} = 4 mA
Digital IO pin high level output voltage TIMEPULSE	V _{oh}	VCC - 0.4			V	I _{oh} = 2 mA I _{oh} = 4 mA

¹¹ Exceeding the ramp speed may permanently damage the device

¹² To measure the I_BCKP the receiver should first be switched on, i.e. VCC and V_BCKP is available. Then set VCC to 0 V while the V_BCKP remains available. Afterward measure the current consumption at the V_BCKP.

¹³ The value has been characterized at 25 °C ambient temperature.

Parameter	Symbol	Min	Typical	Max	Units	Condition
DC current through any digital I/O pin (except supplies)	I _{pin}			5	mA	
VCC_RF voltage	VCC_RF		VCC - 0.1		V	
VCC_RF output current	ICC_RF			50	mA	
Receiver chain noise figure ¹⁴	NF _{tot}		4		dB	
External gain (at RF_IN) ¹⁵	Ext_gain	6		30	dB	
Operating temperature	Topr	-40	+25	+85	°C	

Table 10: Operating conditions

4.3 Indicative power requirements

Table 11 provides examples of typical current requirements when using a cold start command. The given values are total system supply current for a possible application including RF and baseband sections.

All values in Table 11 have been measured at 25 °C ambient temperature.



The actual power requirements vary depending on the FW version used, external circuitry, number of satellites tracked, signal strength, type and time of start, duration, and conditions of test.

Symbol	Parameter	Conditions	GPS+GLO +GAL+BDS	GPS	Unit
I _{PEAK}	Peak current	Acquisition	140	130	mA
I _{VCC} ¹⁶	VCC current	Acquisition	100	85	mA
I _{VCC} ¹⁶	VCC current	Tracking	95	78	mA

Table 11: Currents to calculate the indicative power requirements

¹⁴ Only valid for GPS

¹⁵ Overall gain from antenna feed

¹⁶ Simulated GNSS signal

5 Communications interfaces

The LEA-F9T has several communications interfaces¹⁷, including UART, SPI, I2C and USB.

All the inputs have internal pull-up resistors in normal operation and can be left open if not used. All the PIOs are supplied by VCC, therefore all the voltage levels of the PIO pins are related to VCC supply voltage.

5.1 UART

The LEA-F9T has one UART interface which supports configurable baud rates. See the integration manual [1].

Hardware flow control is not supported.

The UART is enabled if D_SEL pin of the module is left open or "high".

Symbol	Parameter	Min	Max	Unit
R_u	Baud rate	9600	921600	bit/s
Δ_{Tx}	Tx baud rate accuracy	-1%	+1%	-
Δ_{Rx}	Rx baud rate tolerance	-2.5%	+2.5%	-

Table 12: LEA-F9T UART specifications

5.2 SPI

The SPI interface is disabled by default. The SPI interface shares pins with UART and I2C and can be selected by setting D_SEL = 0. The SPI interface can be operated in peripheral mode only. The maximum transfer rate using SPI is 125 kB/s and the maximum SPI clock frequency is 5.5 MHz.

The SPI timing parameters for peripheral operation are defined in Figure 3. Default SPI configuration is CPOL = 0 and CPHA = 0.

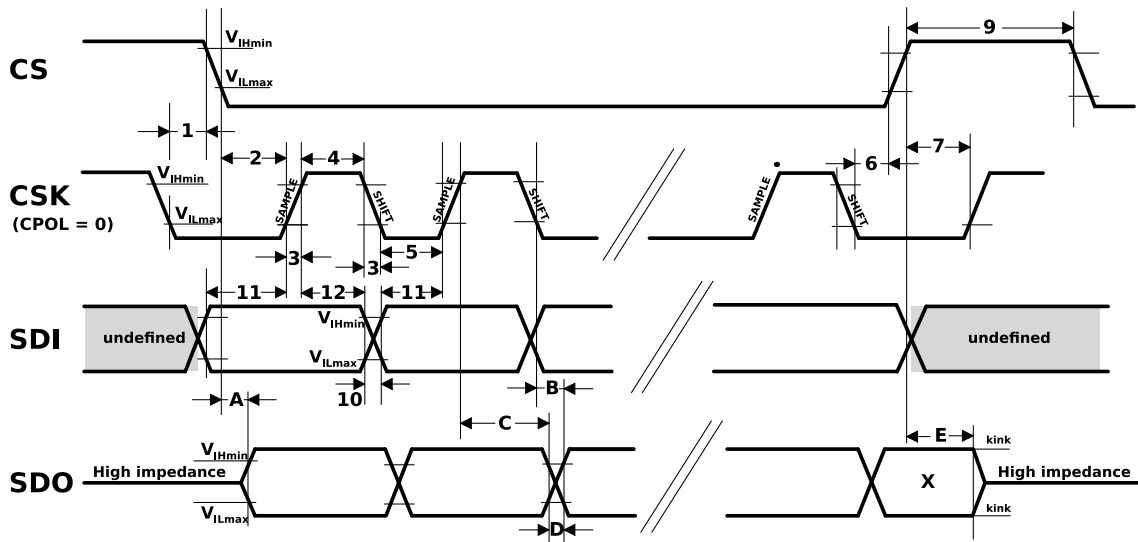

Figure 3: LEA-F9T SPI specification mode 1: CPHA=0 SCK = 5.33 MHz

¹⁷ The signal names and related terms have been replaced with new terminology in this document.

Symbol	Parameter	Min	Max	Unit
1	CS deassertion hold time	23	-	ns
2	Chip select time (CS to SCK)	20	-	ns
3	SCK rise/fall time	-	7	ns
4	SCK high time	24	-	ns
5	SCK low time	24	-	ns
6	Chip deselect time (SCK falling to CS)	30	-	ns
7	Chip deselect time (CS to SCK)	30	-	ns
9	CS high time	32	-	ns
10	SDI transition time	-	7	ns
11	SDI setup time	16	-	ns
12	SDI hold time	24	-	ns

Table 13: SPI peripheral input timing parameters 1 - 12

Symbol	Parameter	Min	Max	Unit
A	SDO data valid time (CS)	12	40	ns
B	SDO data valid time (SCK), weak driver mode	15	40	ns
C	SDO data hold time	100	140	ns
D	SDO rise/fall time, weak driver mode	0	5	ns
E	SDO data disable lag time	15	35	ns

Table 14: SPI peripheral timing parameters A - E, 2 pF load capacitance

Symbol	Parameter	Min	Max	Unit
A	SDO data valid time (CS)	16	55	ns
B	SDO data valid time (SCK), weak driver mode	20	55	ns
C	SDO data hold time	100	150	ns
D	SDO rise/fall time, weak driver mode	3	20	ns
E	SDO data disable lag time	15	35	ns

Table 15: SPI peripheral timing parameters A - E, 20 pF load capacitance

Symbol	Parameter	Min	Max	Unit
A	SDO data valid time (CS)	26	85	ns
B	SDO data valid time (SCK), weak driver mode	30	85	ns
C	SDO data hold time	110	160	ns
D	SDO rise/fall time, weak driver mode	13	45	ns
E	SDO data disable lag time	15	35	ns

Table 16: SPI peripheral timing parameters A - E, 60 pF load capacitance

5.3 I2C

An I2C interface is available for communication with an external host CPU in I2C Fast-mode. Backwards compatibility with Standard-mode I2C bus operation is not supported. The interface can be operated only in peripheral mode with a maximum bit rate of 400 kbit/s. The interface can make use of clock stretching by holding the SCL line LOW to pause a transaction. In this case, the bit transfer rate is reduced. The maximum clock stretching time is 20 ms.

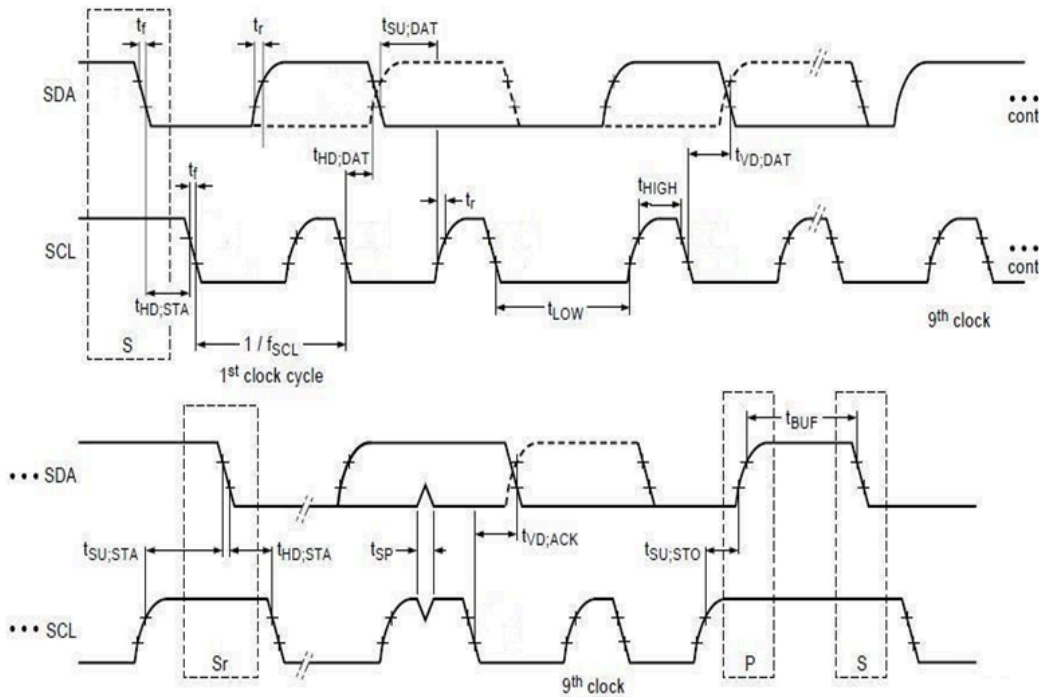
Figure 4: LEA-F9T I2C peripheral specification

Symbol	Parameter	I2C Fast-mode		Unit
		Min	Max	
f_{SCL}	SCL clock frequency	0	400	kHz
$t_{HD;STA}$	Hold time (repeated) START condition	0.6	-	μ s
t_{LOW}	Low period of the SCL clock	1.3	-	μ s
t_{HIGH}	High period of the SCL clock	0.6	-	μ s
$t_{SU;STA}$	Setup time for a repeated START condition	0.6	-	μ s
$t_{HD;DAT}$	Data hold time	0 ¹⁸	- ¹⁹	μ s
$t_{SU;DAT}$	Data setup time	100 ²⁰	-	ns
t_r	Rise time of both SDA and SCL signals	-	300 (for C = 400pF)	ns
t_f	Fall time of both SDA and SCL signals	-	300 (for C = 400pF)	ns
$t_{SU;STO}$	Setup time for STOP condition	0.6	-	μ s
t_{BUF}	Bus-free time between a STOP and START condition	1.3	-	μ s
$t_{VD;DAT}$	Data valid time	-	0.9 ¹⁹	μ s
$t_{VD;ACK}$	Data valid acknowledge time	-	0.9 ¹⁹	μ s
V_{nL}	Noise margin at the low level	0.1 VCC	-	V
V_{nH}	Noise margin at the high level	0.2 VCC	-	V

Table 17: LEA-F9T I2C peripheral timings and specifications

¹⁸ External device must provide a hold time of at least one transition time (max 300 ns) for the SDA signal (with respect to the min V_{ih} of the SCL signal) to bridge the undefined region of the falling edge of SCL.

¹⁹ The maximum $t_{HD;DAT}$ must be less than the maximum $t_{VD;DAT}$ or $t_{VD;ACK}$ with a maximum of 0.9 μ s by a transition time. This maximum must only be met if the device does not stretch the LOW period (t_{LOW}) of the SCL signal. If the clock stretches the SCL, the data must be valid by the set-up time before it releases the clock.

²⁰ When the I2C peripheral is stretching the clock, the $t_{SU;DAT}$ of the first bit of the next byte is 62.5 ns.

 The I2C interface is only available with the UART default mode. If the SPI interface is selected by using D_SEL = 0, the I2C interface is not available.

5.4 USB

The USB 2.0 FS (full speed, 12 Mbit/s) interface can be used for host communication. Due to the hardware implementation, it may not be possible to certify the USB interface. The V_USB pin supplies the USB interface.

5.5 Default interface settings

Interface	Settings
UART1 output	115200 baud, 8 bits, no parity bit, 1 stop bit. NMEA protocol with GGA, GLL, GSA, GSV, RMC, VTG, TXT, ZDA messages are output by default. UBX and RTCM 3.3 protocols are enabled by default but no output messages are enabled by default.
UART1 input	115200 baud, 8 bits, no parity bit, 1 stop bit. UBX, NMEA and RTCM 3.3 input protocols are enabled by default.
USB	Default messages activated as in UART1. Input/output protocols available as in UART1.
I2C	Available for communication in the Fast-mode with an external host CPU in peripheral mode only. Default messages activated as in UART1. Input/output protocols available as in UART1. Maximum bit rate 400 kb/s.
SPI	Allow communication to a host CPU, operated in peripheral mode only. Default messages activated as in UART1. Input/output protocols available as in UART1. SPI is not available unless D_SEL pin is set to low (see section D_SEL interface in Integration manual [1]).

Table 18: Default interface settings

 Refer to the applicable Interface description [2] for information about further settings.

 By default, the LEA-F9T outputs NMEA messages that include satellite data for all GNSS bands being received. This results in a high NMEA output load for each navigation period. Make sure the UART baud rate used is sufficient for the selected navigation rate and the number of GNSS signals being received.

6 Mechanical specification

4:1

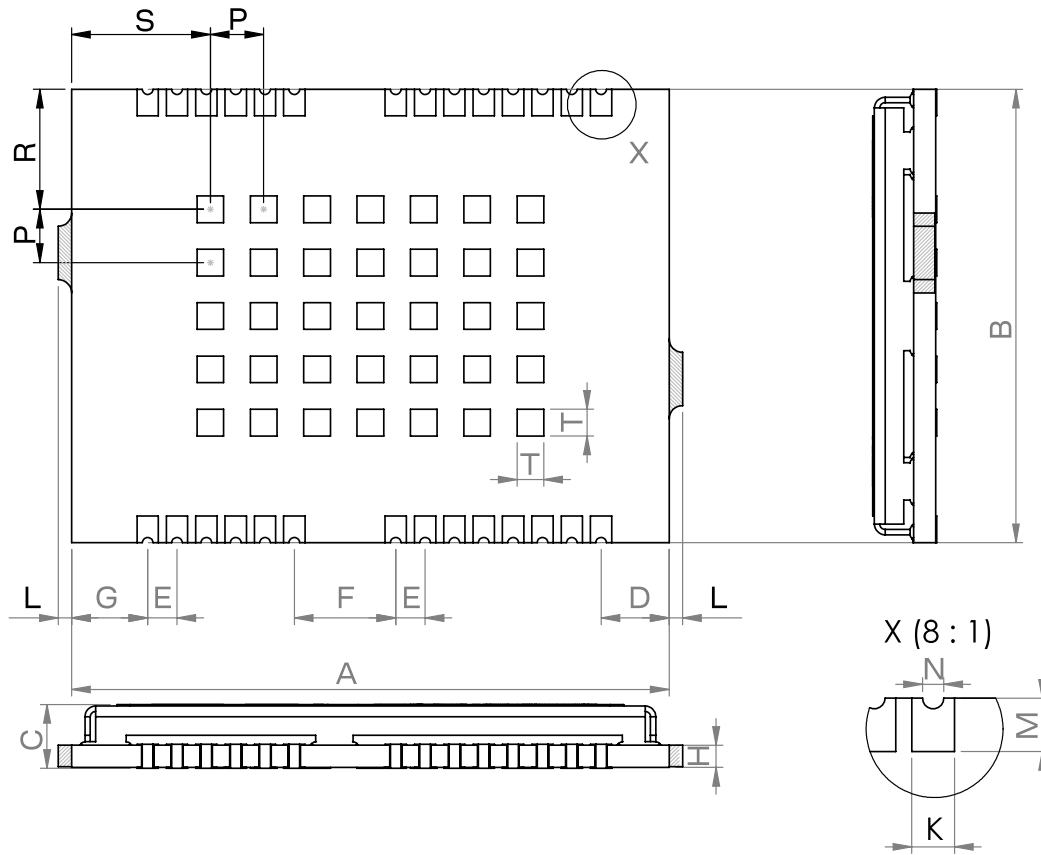

Figure 5: LEA-F9T mechanical drawing

Symbol	Min (mm)	Typical (mm)	Max (mm)
A	22.3	22.4	22.5
B	16.9	17.0	17.1
C	2.1	2.4	2.7
D	2.45	2.55	2.65
E	1.0	1.1	1.2
F	3.7	3.8	3.9
G	2.75	2.85	2.95
H		0.82	
K	0.7	0.8	0.9
M	0.9	1.0	1.1
N	0.4	0.5	0.6
P	1.95	2.0	2.05

Symbol	Min (mm)	Typical (mm)	Max (mm)
R	4.3	4.5	4.7
S	5.0	5.2	5.2
T	0.8	1.0	1.2
L			0.3
Weight		1.9 g	

Table 19: LEA-F9T mechanical dimensions

The mechanical picture of the de-paneling residual tabs (L) is an approximate representation. The shape and position may vary.



Take the size of the de-paneling residual tabs into account when designing the component keep-out area.

7 Qualifications and approvals

Quality and reliability	
Product qualification	Qualified according to u-blox qualification policy, based on a subset of AEC-Q104
Chip qualification	Modules are based on AEC-Q100 qualified GNSS chips
Manufacturing	Manufactured at ISO/TS 16949 certified sites
Environmental	
RoHS compliance	Yes
Moisture sensitivity level (MSL) ^{21 22}	4
Type approvals	
European RED certification (CE)	Declaration of Conformity (DoC) is available on the u-blox website .
UK conformity assessment (UKCA)	Yes

Table 20: Qualifications and approvals

²¹ For the MSL standard, see IPC/JEDEC J-STD-020 and J-STD-033, available on www.jedec.org

²² For more information regarding moisture sensitivity levels, labelling, storage and drying, see the Product packaging reference guide [3]

8 Labeling and ordering information

This section provides information about product labeling and ordering. For information about moisture sensitivity level (MSL), product handling and soldering see the Integration manual [1].

8.1 Product labeling

The labeling of the LEA-F9T modules provides product information and revision information. For more information contact u-blox sales.

8.2 Explanation of product codes

Three product code formats are used in the LEA-F9T labels. The **Product name** used in documentation such as this data sheet identifies all u-blox products, independent of packaging and quality grade. The **Ordering code** includes options and quality, while the **Type number** includes the hardware and firmware versions.

Table 21 below details these three formats.

Format	Structure	Product code
Product name	PPP-TGV	LEA-F9T
Ordering code	PPP-TGV-NNQ	LEA-F9T-20B
Type number	PPP-TGV-NNQ-XX	LEA-F9T-20B-01

Table 21: Product code formats

The parts of the product code are explained in Table 22.

Code	Meaning	Example
PPP	Product family	LEA
TG	Platform	F9 = u-blox F9
V	Variant	T = Timing
NNQ	Option / Quality grade	NN: Option [00...99] Q: Grade, A = Automotive, B = Professional
XX	Product detail	Describes hardware and firmware versions

Table 22: Part identification code

8.3 Ordering codes

Ordering code	Product	Remark
LEA-F9T-20B	u-blox LEA-F9T	

Table 23: Product ordering codes



Product changes affecting form, fit or function are documented by u-blox. For a list of Product Change Notifications (PCNs) see our website at: <https://www.u-blox.com/en/product-resources>.

Related documents

- [1] LEA-F9T Integration manual, [UBX-20032109](#)
- [2] TIM 2.22 Interface description [UBX-23004791](#)
- [3] Product packaging reference guide [UBX-14001652](#)
- [4] Radio Resource LCS Protocol (RRLP), (3GPP TS 44.031 version 11.0.0 Release 11)



For regular updates to u-blox documentation and to receive product change notifications please register on our homepage <https://www.u-blox.com>.

Revision history

Revision	Date	Status / comments
R01	13-Dec-2022	Advance information
R02	19-Jun-2023	Firmware version to TIM2.22 Updated product status to initial production Updated specifications: <ul style="list-style-type: none">• Maximum navigation update rate changed• I2C and SPI timing specifications in section Communications interfaces• VCC_RF output current in table Absolute maximum ratings• Backup current in table Operating conditions• Added timepulse details in table Operating conditions
R03	21-Mar-2024	Updated product type number Updated sections: <ul style="list-style-type: none">• Mechanical specifications with information on de-paneling residual tabs• Qualifications and approvals• Information on moisture sensitivity level has been moved from the Intergration manual to chapter Qualifications and approvals

Contact



u-blox AG

Address: Zürcherstrasse 68
8800 Thalwil
Switzerland

For further support and contact information, visit us at www.u-blox.com/support.

Looking for pricing, stock, or lifecycle information?

Click below to explore more details on WIN SOURCE:

-  [View LEA-F9T-20B on WIN SOURCE](#)
-  [U-blox Information](#)

Optimize Your Supply Chain with WIN SOURCE Solutions

-  Global Sourcing Solution
-  Obsolete Management
-  Cost Control Management
-  Shortage Management
-  Alternative Solution
-  Excess Inventory Management